

COMMONWEALTH OF MASSACHUSETTS



---

**CONTRACT DOCUMENTS  
AND SPECIAL PROVISIONS**

---

|              |                |
|--------------|----------------|
| PROPOSAL NO. | 607680-124171  |
| P.V. =       | \$5,783,000.00 |
| PLANS        | YES            |

FOR

**Bridge Rehabilitation, F-04-010, River Street (ST 31)  
over North Nashua River**

**in the City of**

**FITCHBURG**

In accordance with the STANDARD SPECIFICATIONS  
for HIGHWAYS and BRIDGES dated 2023

This Proposal to be opened and read:

**TUESDAY, DECEMBER 5, 2023 at 2:00 P.M.**

THIS PAGE INTENTIONALLY LEFT BLANK

DOCUMENT 00010

TABLE OF CONTENTS

DOCUMENT 00010  
TABLE OF CONTENTS ..... 00010-1 through 4

DOCUMENT 00102  
NOTICE TO CONTRACTORS ..... 00102-1 through 2

DOCUMENT 00210  
REQUIREMENTS OF MASSACHUSETTS GENERAL  
LAWS CHAPTER 30, SECTION 39R; CHAPTER 30, SECTION 39O ..... 00210-1 through 4

DOCUMENT 00331  
LOCUS MAP ..... 00331-1 through 2

DOCUMENT 00439  
CONTRACTOR PROJECT EVALUATION FORM ..... 00439-1 through 2

DOCUMENT 00440  
SUBCONTRACTOR PROJECT EVALUATION FORM ..... 00440-1 through 2

DOCUMENT 00710  
GENERAL CONTRACT PROVISIONS..... 00710-1 through 2

DOCUMENT 00713  
SUBSECTION 701 CEMENT CONCRETE SIDEWALKS, PEDESTRIAN CURB  
RAMPS, AND DRIVEWAYS AND GUIDE TO THE INTERIM SUBSECTION 701  
CEMENT CONCRETE SIDEWALK SPECIFICATION..... 00713-1 through 34

DOCUMENT 00715  
SUPPLEMENTAL SPECIFICATIONS ..... 00715-1 through 46

DOCUMENT 00718  
SPECIAL PROVISION FOR PARTICIPATION BY MINORITY OR WOMEN'S  
BUSINESS ENTERPRISES AND SERVICE- DISABLED VETERAN- OWNED  
BUSINESS ENTERPRISES ..... 00718-1 through 10

DOCUMENT 00761  
SPECIAL PROVISIONS FOR CERTIFICATION REGARDING DEBARMENT,  
SUSPENSION, INELIGIBILITY AND VOLUNTARY EXCLUSION ..... 00761-1 through 4

DOCUMENT 00811  
MONTHLY PRICE ADJUSTMENT FOR HOT MIX ASPHALT  
(HMA) MIXTURES..... 00811-1 through 2

DOCUMENT 00812  
MONTHLY PRICE ADJUSTMENT FOR DIESEL FUEL AND GASOLINE ..... 00812-1 through 2

DOCUMENT 00813  
PRICE ADJUSTMENT FOR STRUCTURAL STEEL  
AND REINFORCING STEEL ..... 00813-1 through 4

DOCUMENT 00814  
PRICE ADJUSTMENT FOR PORTLAND CEMENT CONCRETE MIXES ..... 00814-1 through 2

TABLE OF CONTENTS (Continued)

DOCUMENT 00820  
THE COMMONWEALTH OF MASSACHUSETTS  
SUPPLEMENTAL EQUAL EMPLOYMENT OPPORTUNITY,  
NON-DISCRIMINATION AND AFFIRMATIVE ACTION PROGRAM ..... 00820-1 through 6

DOCUMENT 00821  
ELECTRONIC REPORTING REQUIREMENTS  
CIVIL RIGHTS PROGRAM AND CERTIFIED PAYROLL ..... 00821-1 through 2

DOCUMENT 00859  
CONTRACTOR/SUBCONTRACTOR CERTIFICATION FORM ..... 00859-1 through 2

DOCUMENT 00860  
COMMONWEALTH OF MASSACHUSETTS PUBLIC EMPLOYMENT LAWS ..... 00860-1 through 2

DOCUMENT 00861  
STATE PREVAILING WAGE RATES ..... 00861-1 through 42

DOCUMENT A00801  
SPECIAL PROVISIONS ..... A00801-1 through 172

DOCUMENT A00802  
DETAIL SHEETS ..... A00802-1 through 16

DOCUMENT A00807  
CITY OF FITCHBURG  
STANDARD SPECIFICATIONS ..... A00807-1 through 46

DOCUMENT A00808  
PROJECT UTILITY COORDINATION FORM ..... A00808-1 through 6

DOCUMENT A00815  
WORK ZONE SAFETY  
TEMPORARY TRAFFIC CONTROL ..... A00815-1 through 86

DOCUMENT A00820  
REQUEST FOR RELEASE OF MASSDOT AUTOCAD FILES FORM ..... A00820-1 through 2

DOCUMENT A00830  
ARMY CORPS OF ENGINEERS  
SELF-VERIFICATION NOTIFICATION ..... A00830-1 through 58

DOCUMENT A00831  
ARMY CORPS OF ENGINEERS  
GENERAL PERMIT ..... A00831-1 through 94

DOCUMENT A00860  
MASSACHUSETTS DEPARTMENT OF ENVIRONMENTAL PROTECTION  
NOTICE OF INTENT ..... A00860-1 through 76

DOCUMENT A00861  
MASSACHUSETTS DEPARTMENT OF ENVIRONMENTAL PROTECTION  
ORDER OF CONDITIONS ..... A00861-1 through 16

TABLE OF CONTENTS (Continued)

DOCUMENT A00871  
UNITED STATES DEPARTMENT OF THE INTERIOR  
FISH AND WILDLIFE SERVICE  
CONSISTENCY LETTER..... A00871-1 through 10

DOCUMENT A00875  
POLICY DIRECTIVE P-22-001 AND POLICY DIRECTIVE P-22-002 ..... A00875-1 through 8

DOCUMENT B00420  
PROPOSAL.....B00420-1 through 18

DOCUMENT B00842  
SCHEDULE OF PARTICIPATION BY MINORITY OR WOMEN BUSINESS  
ENTERPRISE (M/WBE) .....B00842-1 through 2

DOCUMENT B00843  
MINORITY OR WOMENS BUSINESS ENTERPRISE PARTICIPATION  
LETTER OF INTENT.....B00843-1 through 2

DOCUMENT B00846  
M/WBE OR SDVOBE JOINT CHECK ARRANGEMENT APPROVAL FORM.....B00846-1 through 2

DOCUMENT B00847  
JOINT VENTURE AFFIDAVIT .....B00847-1 through 4

\*\*\* END OF DOCUMENT \*\*\*

THIS PAGE INTENTIONALLY LEFT BLANK

DOCUMENT 00102

**NOTICE TO CONTRACTORS**

Electronic proposals for the following project will be received through the internet using Bid Express until the date and time stated below and will be posted on [www.bidx.com](http://www.bidx.com) forthwith after the bid submission deadline. No paper copies of bids will be accepted. All Bidders must have a valid vendor code issued by MassDOT in order to bid on projects. Bidders need to apply for a Digital ID at least 14 days prior to a scheduled bid opening date with Bid Express.

**TUESDAY, DECEMBER 5, 2023 at 2:00 P.M. \*\***

**FITCHBURG**

**Bridge Rehabilitation, F-04-010, River Street (ST 31) over North Nashua River**

**\*\*Date Subject to Change**

PROJECT VALUE = \$5,783,000.00

Bidders must be pre-qualified by the Department in the BRIDGE – CONSTRUCTION category to bid on the above project. An award will not be made to a Contractor who is not pre-qualified by the Department prior to the opening of Proposals.

All prospective Bidders who intend to bid on this project must obtain “Request Proposal Form (R109)”. The blank “Request Proposal Form (R109)” can be obtained at:  
<https://www.mass.gov/prequalification-of-horizontal-construction-firms>.

All prospective Bidders must complete and e-mail an electronic copy of “Request Proposal Form (R109)” to the MassDOT Director of Prequalification for approval:  
[prequal.r109@dot.state.ma.us](mailto:prequal.r109@dot.state.ma.us).

Proposal documents for official bidders are posted on [www.bidx.com](http://www.bidx.com). Other interested parties may receive informational Contract Documents containing the Plans and Special Provisions, free of charge.

Bids will be considered, and the contract awarded in accordance with statutes governing such contracts in accordance with Massachusetts General Laws Chapter 30 § 39M.

The Project Bids File Attachments folder for proposals at [www.bidx.com](http://www.bidx.com) shall be used for submitting at the time of bid required information such as the Bid Bond required document, and other documents that may be requested in the proposal.

---

**NOTICE TO CONTRACTORS** (Continued)

All parties who wish to have access to information plans and specification must send a “Request for Informational Documents” to [MassDOTBidDocuments@dot.state.ma.us](mailto:MassDOTBidDocuments@dot.state.ma.us).

A Proposal Guaranty in the amount of 5% of the value of the bid is required.

This project is subject to the schedule of prevailing wage rates as determined by the Commissioner of the Massachusetts Department of Labor and Workforce Development, and the Division of Occupational Safety.

Plans will be on display and information will be available at the MassDOT Boston Office and at the District Office in WORCESTER.

**PRICE ADJUSTMENTS**

This Contract contains price adjustments for hot mix asphalt and Portland cement mixtures, diesel fuel, and gasoline. For reference the base prices are as follows: liquid asphalt \$637.50 per ton, Portland cement \$181.15 per ton, diesel fuel \$3.751 per gallon, and gasoline \$3.032 per gallon, and Steel Base Price Index 461.3. MassDOT posts the **Price Adjustments** on their Highway Division’s website at <https://www.mass.gov/massdot-contract-price-adjustments>

This Contract contains Price Adjustments for steel. See Document 00813 - PRICE ADJUSTMENT FOR STRUCTURAL STEEL AND REINFORCING STEEL for their application and base prices.

MassDOT projects are subject to the rules and regulations of the Architectural Access Board (521 CMR 1.00 et seq.)

Prospective bidders and interested parties can access this information and more via the internet at [WWW.COMMBUYS.COM](http://WWW.COMMBUYS.COM).

BY: Monica G. Tibbits-Nutt, Acting Secretary and CEO, MassDOT  
Jonathan L. Gulliver, Administrator, MassDOT Highway Division  
SATURDAY, SEPTEMBER 23, 2023



DOCUMENT 00210

REQUIREMENTS OF MASSACHUSETTS GENERAL LAWS  
CHAPTER 30, SECTION 39R;  
CHAPTER 30, SECTION 39O

July 1, 1981, updated October 2016

**M.G.L. c. 30, § 39R. Award of Contracts; Accounting Statements; Annual Financial Statements; Definitions.**

(a) The words defined herein shall have the meaning stated below whenever they appear in this section:

- (1) "Contractor" means any person, corporation, partnership, joint venture, sole proprietorship, or other entity awarded a contract pursuant to sections thirty-eight A1/2 to thirty-eight O, inclusive, of chapter seven and any contract awarded or executed pursuant to section eleven C of chapter twenty-five A, section thirty-nine M of chapter thirty, or sections forty-four A to forty-four H, inclusive, of chapter one hundred and forty-nine, which is for an amount or estimated amount greater than one hundred thousand dollars.
- (2) "Contract" means any contract awarded or executed pursuant to sections thirty-eight A1/2 to thirty-eight O, inclusive, of chapter seven and any contract awarded or executed pursuant to section eleven C of chapter twenty-five A, section thirty-nine M of chapter thirty, or sections forty-four A through forty-four H, inclusive, of chapter one hundred and forty-nine, which is for amount or estimated amount greater than one hundred thousand dollars.
- (3) "Records" means books of original entry, accounts, checks, bank statements and all other banking documents, correspondence, memoranda, invoices, computer printouts, tapes, discs, papers and other documents or transcribed information of any type, whether expressed in ordinary or machine language.
- (4) "Independent Certified Public Accountant" means a person duly registered in good standing and entitled to practice as a certified public accountant under the laws of the place of his residence or principal office and who is in fact independent. In determining whether an accountant is independent with respect to a particular person, appropriate consideration should be given to all relationships between the accountant and that person or any affiliate thereof. Determination of an accountant's independence shall not be confined to the relationships existing in connection with the filing of reports with the awarding authority.
- (5) "Audit", when used in regard to financial statements, means an examination of records by an independent certified public accountant in accordance with generally accepted accounting principles and auditing standards for the purpose of expressing a certified opinion thereon, or, in the alternative, a qualified opinion or a declination to express an opinion for stated reasons.
- (6) "Accountant's Report", when used in regard to financial statements, means a document in which an independent certified public accountant indicates the scope of the audit which he has made and sets forth his opinion regarding the financial statements taken as a whole with a listing of noted exceptions and qualifications, or an assertion to the effect that an overall opinion cannot be expressed. When an overall opinion cannot be expressed the reason therefor shall be stated. An accountant's report shall include as a part thereof a signed statement by the responsible corporate officer attesting that management has fully disclosed all material facts to the independent certified public accountant, and that the audited financial statement is a true and complete statement of the financial condition of the contractor.
- (7) "Management", when used herein, means the chief executive officers, partners, principals or other person or persons primarily responsible for the financial and operational policies and practices of the contractor.
- (8) Accounting terms, unless otherwise defined herein, shall have a meaning in accordance with generally accepted accounting principles and auditing standards.

(b) Subsection (a)(2) hereof notwithstanding, every agreement or contract awarded or executed pursuant to sections thirty-eight A 1/2 to thirty-eight O, inclusive, of chapter seven, or eleven C of chapter twenty-five A, and pursuant to section thirty-nine M of chapter thirty or to section forty-four A through H, inclusive, of chapter one hundred and forty-nine, shall provide that:

- (1) The contractor shall make, and keep for at least six years after final payment, books, records, and accounts which in reasonable detail accurately and fairly reflect the transactions and dispositions of the contractor, and
- (2) Until the expiration of six years after final payment, the office of inspector general, and the commissioner of capital asset management and maintenance shall have the right to examine any books, documents, papers or records of the contractor or of his subcontractors that directly pertain to, and involve transactions relating to, the contractor or his subcontractors, and
- (3) If the agreement is a contract as defined herein, the contractor shall describe any change in the method of maintaining records or recording transactions which materially affect any statements filed with the awarding authority, including in his description the date of the change and reasons therefor, and shall accompany said description with a letter from the contractor's independent certified public accountant approving or otherwise commenting on the changes, and
- (4) If the agreement is a contract as defined herein, the contractor has filed a statement of management on internal accounting controls as set forth in paragraph (c) below prior to the execution of the contract, and
- (5) If the agreement is a contract as defined herein, the contractor has filed prior to the execution of the contracts and will continue to file annually, an audited financial statement for the most recent completed fiscal year as set forth in paragraph (d) below.

(c) Every contractor awarded a contract shall file with the awarding authority a statement of management as to whether the system of internal accounting controls of the contractor and its subsidiaries reasonably assures that:

- (1) transactions are executed in accordance with management's general and specific authorization;
- (2) transactions are recorded as necessary
  - i. to permit preparation of financial statements in conformity with generally accepted accounting principles, and
  - ii. to maintain accountability for assets;
- (3) access to assets is permitted only in accordance with management's general or specific authorization; and
- (4) the recorded accountability for assets is compared with the existing assets at reasonable intervals and appropriate action was taken with respect to any difference.

Every contractor awarded a contract shall also file with the awarding authority a statement prepared and signed by an independent certified public accountant, stating that he has examined the statement of management on internal accounting controls, and expressing an opinion as to:

- (1) whether the representations of management in response to this paragraph and paragraph (b) above are consistent with the result of management's evaluation of the system of internal accounting controls; and
- (2) whether such representations of management are, in addition, reasonable with respect to transactions and assets in amounts which would be material when measured in relation to the applicant's financial statements.



THIS PAGE INTENTIONALLY LEFT BLANK

DOCUMENT 00331

**LOCUS MAP**

**FITCHBURG**

**Bridge Rehabilitation, F-04-010, River Street (ST 31) over North Nashua River**

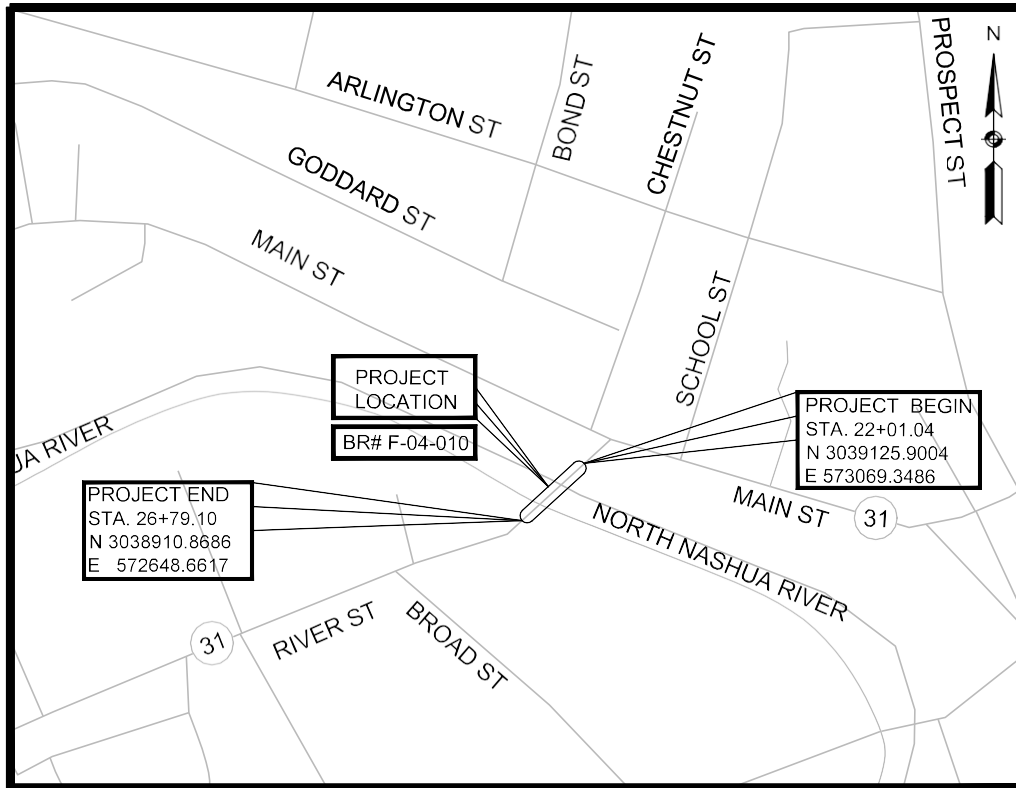

NOT TO SCALE

THIS PAGE INTENTIONALLY LEFT BLANK

DOCUMENT 00439



Final Report

Interim Report

## CONTRACTOR PROJECT EVALUATION FORM

*For instructions on using this form, see Engineering Directive E-10-002, Dated 4/20/2010*

Date: \_\_\_\_\_

City/Town: \_\_\_\_\_ Contractor: \_\_\_\_\_

Project: \_\_\_\_\_ Address: \_\_\_\_\_

F.A. No. \_\_\_\_\_ Contract Number: \_\_\_\_\_

Bid Price: \_\_\_\_\_ Notice to Proceed: \_\_\_\_\_

Funds: State: \_\_\_\_\_ Fed Aid: \_\_\_\_\_ Current Contract Completion Date: \_\_\_\_\_

Date Work Started: \_\_\_\_\_ Date Work Completed\*: \_\_\_\_\_

Contractor's Superintendent: \_\_\_\_\_

Division: (indicates class of work) Highway: \_\_\_\_\_ Bridge: \_\_\_\_\_ Maintenance: \_\_\_\_\_

\*If work was NOT completed within specified time (including extensions) give reasons on following page.

|   | Excellent<br>10 | Very Good<br>9 | Average<br>8 | 7 | Fair<br>6 | 5 | Poor<br>4 | % Rating               |
|---|-----------------|----------------|--------------|---|-----------|---|-----------|------------------------|
| <b>1. Workmanship</b>                       |                 |                |              |   |           |   |           | x 2=                   |
| <b>2. Safety</b>                            |                 |                |              |   |           |   |           | x 2=                   |
| <b>3. Schedule</b>                          |                 |                |              |   |           |   |           | x 1.5=                 |
| <b>4. Home Office Support</b>               |                 |                |              |   |           |   |           | x 1=                   |
| <b>5. Subcontractors Performance</b>        |                 |                |              |   |           |   |           | x 1=                   |
| <b>6. Field Supervision/ Superintendent</b> |                 |                |              |   |           |   |           | x 1=                   |
| <b>7. Contract Compliance</b>               |                 |                |              |   |           |   |           | x 0.5=                 |
| <b>8. Equipment</b>                         |                 |                |              |   |           |   |           | x 0.5=                 |
| <b>9. Payment of Accounts</b>               |                 |                |              |   |           |   |           | x 0.5=                 |
| <b>(use back for additional comments)</b>   |                 |                |              |   |           |   |           | <b>Overall Rating:</b> |

*(Give explanation of items 1 through 9 on the following page in numerical order if overall rating is below 80%. Use additional sheets if necessary.)*

\_\_\_\_\_  
District Construction Engineer's Signature/Date

\_\_\_\_\_  
Resident Engineer's Signature/Date

\_\_\_\_\_  
Contractor's Signature Acknowledging Report/Date

Contractor Requests Meeting with the District: No  Yes  Date Meeting Held: \_\_\_\_\_

Contractor's Comments/Meeting Notes (extra sheets may be added to this form and noted here if needed): \_\_\_\_\_

\_\_\_\_\_

\_\_\_\_\_



**CONTRACTOR PROJECT EVALUATION FORM (Continued)**

Date: \_\_\_\_\_ Contract Number: \_\_\_\_\_

**INFORMATION FOR DISTRICT HIGHWAY DIRECTORS RELATING TO PREQUALIFICATION**

- A deduction shall be recommended for unsatisfactory performance if computed overall rating is under 80%.
- A deduction may be recommended for this project being completed late due to the Contractor's fault.

**RECOMMENDATIONS FOR DEDUCTIONS FROM CONTRACTORS' ASSIGNED FACTOR**

*(Write Yes or No in space provided)*

I recommend a deduction for Contractor's unsatisfactory performance: \_\_\_\_\_

I recommend a deduction for project completed late: \_\_\_\_\_

Signed: \_\_\_\_\_

District Highway Director

EXPLANATION OF RATINGS 1 – 9: \_\_\_\_\_

---

---

---

---

---

---

---

---

---

---

---

---

---

---

---

---

---

---

---

---

---

---

---

---

WORK NOT COMPLETED WITHIN SPECIFIED TIME: \_\_\_\_\_

---

---

---

---

---

---

---

---

---

---

---

---

---

---

---

---

---

---

---

---

---

---

---

---

Revised: 04/28/17

\*\*\* END OF DOCUMENT \*\*\*





Final Report

Interim Report

## SUBCONTRACTOR PROJECT EVALUATION FORM

*For instructions on using this form, see Engineering Directive E-10-002, Dated 4/20/2010*

Date: \_\_\_\_\_

City/Town: \_\_\_\_\_

Subcontractor: \_\_\_\_\_

Project: \_\_\_\_\_

Address: \_\_\_\_\_

F.A. No.: \_\_\_\_\_

Contract Number: \_\_\_\_\_

Prime Contractor \_\_\_\_\_

Current Contract Completion Date: \_\_\_\_\_

Date Work Started: \_\_\_\_\_

Date Work Completed\*: \_\_\_\_\_

Subcontractor's Superintendent: \_\_\_\_\_

Type of Work Performed by Subcontractor: \_\_\_\_\_

\*If work was NOT completed within specified time (including extensions) give reasons on following page.

|   | Excellent<br>10 | Very Good<br>9 | Average<br>8 | 7 | Fair<br>6 | 5 | Poor<br>4 | % Rating               |
|---|-----------------|----------------|--------------|---|-----------|---|-----------|------------------------|
| <b>1. Workmanship</b>                       |                 |                |              |   |           |   |           | x 2=                   |
| <b>2. Safety</b>                            |                 |                |              |   |           |   |           | x 2=                   |
| <b>3. Schedule</b>                          |                 |                |              |   |           |   |           | x 1.5=                 |
| <b>4. Home Office Support</b>               |                 |                |              |   |           |   |           | x 1.5=                 |
| <b>5. Field Supervision/ Superintendent</b> |                 |                |              |   |           |   |           | x 1=                   |
| <b>6. Contract Compliance</b>               |                 |                |              |   |           |   |           | x 1=                   |
| <b>7. Equipment</b>                         |                 |                |              |   |           |   |           | x 0.5=                 |
| <b>8. Payment of Accounts</b>               |                 |                |              |   |           |   |           | x 0.5=                 |
| <b>(use back for additional comments)</b>   |                 |                |              |   |           |   |           | <b>Overall Rating:</b> |

*(Give explanation of items 1 through 8 on the following page in numerical order if overall rating is below 80%. Use additional sheets if necessary.)*

\_\_\_\_\_  
District Construction Engineer's Signature/Date

\_\_\_\_\_  
Resident Engineer's Signature/Date

\_\_\_\_\_  
Contractor Signature Acknowledging Report/Date

\_\_\_\_\_  
Subcontractor Signature Acknowledging Report/Date

Subcontractor Requests Meeting with the District: No  Yes  Date Meeting Held: \_\_\_\_\_

Subcontractor's Comments / Meeting Notes (extra sheets may be added to this form and noted here if needed): \_\_\_\_\_

\_\_\_\_\_

Contractor's Comments: \_\_\_\_\_

\_\_\_\_\_



**SUBCONTRACTOR PROJECT EVALUATION FORM (Continued)**

Date: \_\_\_\_\_ Contract Number: \_\_\_\_\_

**INFORMATION FOR DISTRICT HIGHWAY DIRECTORS RELATING TO PREQUALIFICATION**

A deduction shall be recommended for unsatisfactory performance if computed overall rating is under 80%.  
A deduction may be recommended for this project being completed late due to the Contractor's fault.

**RECOMMENDATIONS FOR DEDUCTIONS FROM CONTRACTORS' ASSIGNED FACTOR**

*(Write Yes or No in space provided)*

I recommend a deduction for Contractor's unsatisfactory performance: \_\_\_\_\_

I recommend a deduction for project completed late: \_\_\_\_\_

Signed: \_\_\_\_\_  
District Highway Director

EXPLANATION OF RATINGS 1 – 8: \_\_\_\_\_

\_\_\_\_\_  
\_\_\_\_\_  
\_\_\_\_\_  
\_\_\_\_\_  
\_\_\_\_\_  
\_\_\_\_\_  
\_\_\_\_\_  
\_\_\_\_\_  
\_\_\_\_\_  
\_\_\_\_\_  
\_\_\_\_\_  
\_\_\_\_\_  
\_\_\_\_\_  
\_\_\_\_\_  
\_\_\_\_\_  
\_\_\_\_\_  
\_\_\_\_\_  
\_\_\_\_\_  
\_\_\_\_\_  
\_\_\_\_\_  
\_\_\_\_\_

WORK NOT COMPLETED WITHIN SPECIFIED TIME: \_\_\_\_\_

\_\_\_\_\_  
\_\_\_\_\_  
\_\_\_\_\_  
\_\_\_\_\_  
\_\_\_\_\_  
\_\_\_\_\_  
\_\_\_\_\_  
\_\_\_\_\_  
\_\_\_\_\_  
\_\_\_\_\_

DOCUMENT 00710  
GENERAL CONTRACT PROVISIONS  
Revised: 04/24/23

NOTICE OF AVAILABILITY

The STANDARD SPECIFICATIONS FOR HIGHWAYS AND BRIDGES dated 2023, the SUPPLEMENTAL SPECIFICATIONS, the 1996 METRIC CONSTRUCTION AND TRAFFIC STANDARD DETAILS, the 1990 STANDARD DRAWINGS FOR SIGNS AND SUPPORTS; the 1968 STANDARD DRAWINGS FOR TRAFFIC SIGNALS AND HIGHWAY LIGHTING and the 2017 CONSTRUCTION STANDARD DETAILS are available online at <https://www.mass.gov/massdot-highway-division-manuals-and-publications>

SPECIAL PROVISIONS FOR RIGHT-TO-KNOW ACT REQUIREMENTS

The Contractor's attention is directed to Massachusetts General Laws, Chapter 111F, commonly known as the Right-To-Know Act, and to the regulations promulgated pursuant thereto. Among the provisions of the Right-To-Know Act is a requirement that employers make available to employees Materials Safety Data Sheets (MSDS) for any substance on the Massachusetts Substance List (MSL) to which employees are, have been, or may be exposed.

To ensure prompt compliance with these regulations and legislation, the Contractor shall:

1. Deliver to the Department, prior to the start of any work under this contract, copies of MSDS for all MSL substances to be used, stored, processed or manufactured at the worksite by the Contractor.
2. Train employees of the Department, who may be exposed to MSL substances as a result of the Contractor's work under this contract, with regard to those specific substances in accordance with requirements of the Right-To-Know Act.
3. Observe all safety precautions recommended on the MSDS for any MSL substance to be used, stored, processed, or manufactured at the worksite by the Contractor.
4. Inform the Department in writing regarding specific protective equipment recommended in the MSDS for MSL substances to which employees of the Department may be exposed as a result of the Contractor's work under this contract.

The Department shall not be liable for any delay or suspension of work caused by the refusal of its employees to perform any work due to the Contractor's failure to comply with the Right-To-Know Act. The Contractor agrees to hold the Department or the Commissioner of the Department harmless and fully indemnified for any and all claims, demands, fines, actions, complaints, and causes of action resulting from or arising out of the Contractor's failure to comply with the requirements of the Right-To-Know Act.

ALTERNATIVE DISPUTE RESOLUTION

Forum, Choice of Law and Mediations:

Any actions arising out of a contract shall be governed by the laws of Massachusetts and shall be brought and maintained in a State or federal court in Massachusetts which shall have exclusive jurisdiction thereof. MassDOT and the Contractor may both agree to mediation of any claim and will share the costs of such mediation pro rata based on the number of parties involved.

\*\*\* END OF DOCUMENT \*\*\*

THIS PAGE INTENTIONALLY LEFT BLANK

DOCUMENT 00713

**Subsection 701**  
**Cement Concrete Sidewalks, Pedestrian Curb Ramps, and Driveways**  
**and**  
**Guide to the Interim Subsection 701**  
**Cement Concrete Sidewalk Specification**

(March 31, 2022)

THIS PAGE INTENTIONALLY LEFT BLANK

**SUSECTION 701: CEMENT CONCRETE SIDEWALKS, PEDESTRIAN CURB RAMPS, AND DRIVEWAYS**

Replace this Subsection with the following:

**INTERIM SUBSECTION 701: CEMENT CONCRETE SIDEWALKS, PEDESTRIAN CURB RAMPS, AND DRIVEWAYS**

**DESCRIPTION**

**701.20: General**

This work shall consist of the construction of cement concrete sidewalks, pedestrian curb ramps, and driveways in accordance with the specifications and within the tolerances established on the plans.

**MATERIALS**

**701.30: General**

Materials shall meet the requirements specified in the following Subsections of Division III, Materials except as noted herein:

|  |                        |
|--|------------------------|
| Gravel Borrow, Type b.....               | M1.03.0                |
| Cement Concrete ( $\geq 4,000$ psi)..... | M4.02.00               |
| Preformed Expansion Joint Filler.....    | M9.14.0 <sup>[1]</sup> |

<sup>[1]</sup> Preformed expansion joint filler shall conform to Subsection M9.14.0 or ASTM D8139.

The following best practices may be incorporated into the cement concrete mix design at no additional cost to the Department as identified herein.

**A. Combined Aggregate System.**

The combined aggregate system for the mix design may be analyzed using the Tarantula Curve, Shilstone Chart, fineness modulus, and coarse aggregate content to enhance the properties of the concrete.

**1. Tarantula Curve.**

The combined aggregate system for the mix design may be analyzed using the Tarantula Curve to evaluate potential properties of the concrete, including workability, segregation, edge slumping, surface finishing, and cohesion.

**Table 701.30-1: Tarantula Curve Particle Size Distribution**

| Sieve Opening | Percent by Mass Targets (%) |          | Percent by Mass Retained (%) |                        |   |
|---------------|-----------------------------|----------|------------------------------|------------------------|---|
|               | Passing                     | Retained |                              |                        |   |
| 1-1/2 in.     | 100                         | –        | –                            | –                      | – |
| 1 in.         | 92                          | 8        | 0 – 16                       | –                      | – |
| 3/4 in.       | 82                          | 10       | 0 – 20                       | –                      | – |
| 1/2 in.       | 69                          | 13       | 4 – 20                       | –                      | – |
| 3/8 in.       | 56                          | 13       | 4 – 20                       | –                      | – |
| No. 4         | 43                          | 13       | 4 – 20                       | –                      | – |
| No. 8         | 37                          | 6        | 0 – 12                       | Coarse Sand<br>20 – 40 | – |
| No. 16        | 31                          | 6        | 0 – 12                       |                        | – |
| No. 30        | 18                          | 13       | 4 – 20                       | Fine Sand<br>24 – 34   | – |
| No. 50        | 5                           | 13       | 4 – 20                       |                        | – |
| No. 100       | 0                           | 5        | 0 – 10                       |                        | – |
| No. 200       | 0                           | 0        | 0 – 2                        |                        | – |

**2. Shilstone Workability-Coarseness Chart.**

The combined aggregate system for the mix design may be analyzed using the Shilstone Workability-Coarseness Chart, to evaluate potential properties of the concrete, including workability.

**Table 701.30-2: Shilstone Workability-Coarseness**

| Zone     | Property   | Cause   |
|----------|--|---|
| Zone I   | Gap-graded; High potential for segregation during placement and consolidation; Cracking, blistering, spalling, and scaling                             | Deficiency in intermediate particles; Non-cohesive    |
| Zone II  | Optimum mixture for nominal maximum aggregate size from 2 in. – 3/4 in.  | Optimized workability factor and coarseness factor    |
| Zone III | Optimum mixture for nominal maximum aggregate size < 3/4 in.   | Optimized workability factor and coarseness factor    |
| Zone IV  | Sticky; High potential for segregation during consolidation and finishing; Variable strength, high shrinkage, cracking, curling, spalling, and scaling | Excessive fines                                       |
| Zone V   | Rocky; Lacking plasticity  | Excessive amount of coarse and intermediate aggregate |



Figure 701.30-1: Shilstone Workability-Coarseness Chart

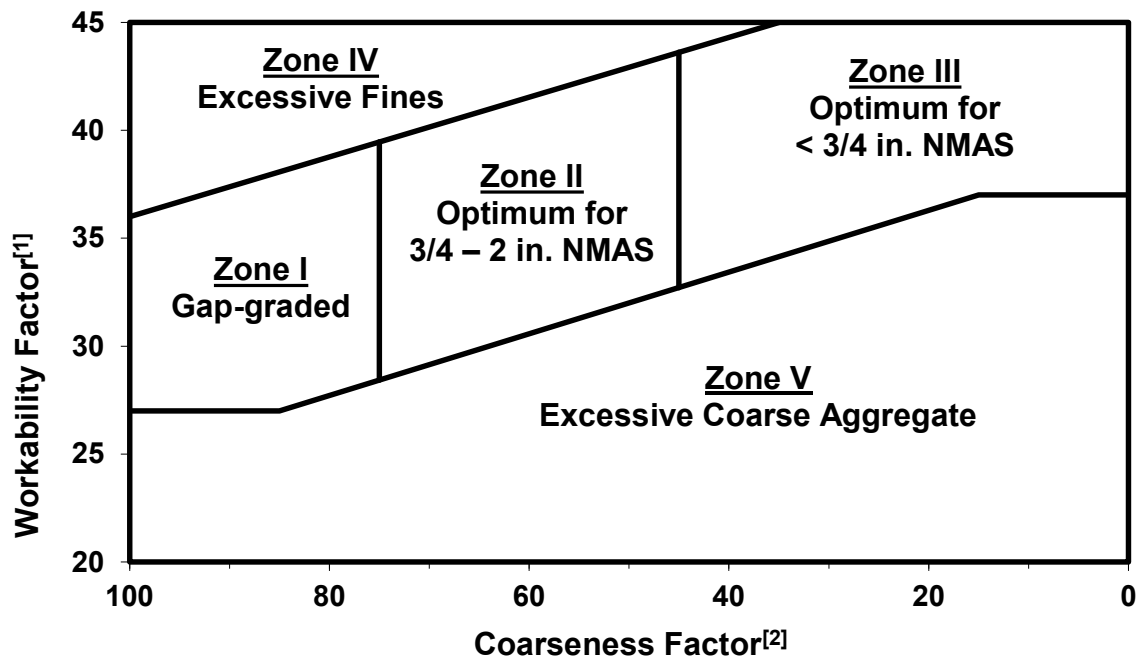

<sup>[1]</sup> The workability factor is determined by the equation  $WF = W + (C - 564) / 38$ , where WF = workability factor, W = percent passing No. 8 sieve and C = total cementitious materials content.

<sup>[2]</sup> The coarseness factor is determined by the equation  $CF = (Q/R) / 100$ , where CF = coarseness factor, Q = cumulative percent retained on 3/8 in. sieve and R = cumulative percent retained on No. 8 sieve.

**3. Fineness Modulus.**

The combined aggregate system for the mix design may be analyzed using the fineness modulus, to evaluate potential properties of the concrete, including the fineness or coarseness of the mix design and estimating the design proportions of fine and coarse aggregates. The coarseness of the mix design increases as the fineness modulus increases. The fineness modulus is determined by calculating the total cumulative percentages by mass retained on each designated sieve and dividing by 100.

**4. Coarse Aggregate Content.**

The combined aggregate system for the mix design may be analyzed using the coarse aggregate content. The coarse aggregate content is determined by calculating the total cumulative percentages by mass retained on the No. 4 sieve.

**B. Paste System.**

The quality of the paste system is determined by the water-cementitious ratio, air content, cementitious materials, and chemical admixtures incorporated into the mix design.

**1. Water-Cementitious Ratio.**

The water-cementitious ratio for the mix design may be analyzed to evaluate potential properties of the concrete, including strength, concrete and reinforcement bonding, and resistance to freezing, thawing, de-icing, sulfate reaction, corrosion of steel reinforcement, drying shrinkage, cracking, and

volume change from wetting and drying. The water-cementitious ratio is determined by calculating the total water content by mass and dividing by the total cement and supplementary cementitious material (SCM) content by mass. The recommended water-cementitious ratio design target is identified in Table 701.30-3. The water-cementitious ratio shall be less than or equal to 0.45.

**Table 701.30-3: Freezing, Thawing, and De-icing Resistance**

| Exposure Class | Severity    | Condition  | Water-Cementitious Ratio |
|----------------|-------------|--|--------------------------|
|                |             |  | Requirement              |
| F3             | Very Severe | Exposed to freezing and thawing cycles and accumulation of snow, ice, and de-icing chemicals; Frequent exposure to water | ≤ 0.45                   |

## 2. Air Content.

The air content for the mix design may be analyzed to evaluate potential properties of the concrete, including strength and resistance to freezing, thawing, de-icing, and sulfate reaction. The recommended air content design targets are identified in Table 701.30-4.

**Table 701.30-4: Freezing, Thawing, and De-icing Resistance**

| Exposure Class | Severity    | Condition  | Nominal Maximum Aggregate Size (in.) | Air Content Target Recommendation (%) |
|----------------|-------------|--|--------------------------------------|---------------------------------------|
| F3             | Very Severe | Exposed to freezing and thawing cycles and accumulation of snow, ice, and de-icing chemicals; Frequent exposure to water | 3/8                                  | 7.5                                   |
|                |             |  | 1/2                                  | 7.0                                   |
|                |             |  | 3/4                                  | 7.0                                   |
|                |             |  | 1                                    | 6.5                                   |
|                |             |  | 1 1/2                                | 6.5                                   |

## 3. Cement and Supplementary Cementitious Materials Content.

The cement and supplementary cementitious materials content incorporated into the mix design shall promote quality properties of the cement concrete, including resistance to alkali silica reaction, freezing, thawing, de-icing, and sulfate reaction. Incorporation of supplementary cementitious materials (SCM) in cement concrete may affect workmanship properties, including workability, bleed rate, setting time, and other properties. Adequate adjustments in Contractor workmanship practices, including placement, finishing, curing, and other construction practices shall be required to account for these changes in properties and to prevent scaling due to freezing, thawing, and de-icing cycles. The cement and supplementary cementitious materials content shall meet the design criteria identified in Table 701.30-5.

**Table 701.30-5: Alkali Silica Reaction and Freezing, Thawing, and De-icing Resistance<sup>[1][2]</sup>**

| Exposure Class | Severity    | Condition  | Material                                      | Replacement by Weight of Cement (%) |
|----------------|-------------|--|---|-------------------------------------|
| F3             | Very Severe | Exposed to freezing and thawing cycles and accumulation of snow, ice, and de-icing chemicals; Frequent exposure to water | Low Alkali Cement ( $\leq 0.60\%$ Alkalinity) | –                                   |
|                |             |  | Blended Hydraulic Cement <sup>[3]</sup>       | –                                   |
|                |             |  | Fly Ash (Class F)                             | 15 – 30                             |
|                |             |  | Slag (Grade 100 or 120)                       | 25 – 50                             |
|                |             |  | Silica Fume                                   | 5 – 10                              |
|                |             |  | Total SCM                                     | $\leq 50$                           |
|                |             |  | Total Fly Ash and Silica Fume                 | $\leq 35$                           |

<sup>[1]</sup> Acceptable replacement by weight of cement for alkali silica reaction resistance shall be determined by the alkali silica reaction resistance performance test results and the criteria identified in Table 701.73-1: Minimum Acceptance Sampling and Testing Requirements.

<sup>[2]</sup> Test results meeting the alkali silica reaction resistance performance criteria of Table 701.30-6: Alternative Performance Evaluation to Alkali Silica Reaction Resistance Design Criteria may supersede the replacement by weight of cement design criteria.

<sup>[3]</sup> SCMs in blended hydraulic cement shall meet the criteria identified for fly ash, slag, and silica fume.

**Table 701.30-6: Alternative Performance Evaluation to Alkali Silica Reaction Resistance Design Criteria**

| Method | Quality Characteristic  | Criteria                   |
|--------|---|----------------------------|
| C295   | Petrographic Examination for Potential Alkali Aggregate Reactive Constituents and Deleterious Materials in Aggregate <sup>[1]</sup> | –                          |
|        | Optically Strained, Microfractured or Microcrystalline Quartz (%)   | $\leq 5.0$                 |
|        | Chert or Chalcedony (%)   | $\leq 3.0$                 |
|        | Trydimite or Cristobalite (%)   | $\leq 1.0$                 |
|        | Opal (%)  | $\leq 0.5$                 |
|        | Natural Volcanic Glass (%)  | $\leq 3.0$                 |
| T 380  | Alkali Silica Reaction Resistance: Expansion of Miniature Concrete Prisms at 56 days (%)  | $\leq 0.03$ <sup>[2]</sup> |

<sup>[1]</sup> Examination of aggregate shall be performed and reported to identify and quantify potential alkali-aggregate reactive constituents and deleterious materials in aggregate, as defined in ASTM C294 Standard Descriptive Nomenclature for Constituents of Concrete Aggregates and ASTM C295 Standard Guide for Petrographic Examination of Aggregates for Concrete.

<sup>[2]</sup> 56-day expansion results greater than 0.03 but less than or equal to 0.04 shall be considered non-reactive if the average two-week rate of expansion from day 56 to day 84 is less than or equal to 0.01%, otherwise, expansion results shall be considered reactive.

#### 4. Chemical Admixtures.

Chemical admixtures may be incorporated into the mix design to enhance the properties of the concrete.

**Table 701.30-7: Chemical Admixtures**

| Spec.                | Type  | Chemical Admixture                      | Properties  |
|----------------------|-------|---|---|
| M 194                | A     | Water-Reducing                          | Increases Workability and Air Content; Decreases Water Demand (5 – 10%, 3 – 6 in. Slump)  |
|                      | B     | Retarding                               | Increases Initial and Final Setting Time, Air Content, Long-Term Strength; Offsetting of Accelerating Effect of Hot Weather; Decreases Early-Age Strength                                   |
|                      | C     | Accelerating                            | Increases Early-Age Strength; Decreases Initial and Final Setting Time  |
|                      | D     | Water-Reducing and Retarding            | Type A and Type B Admixture Properties  |
|                      | E     | Water-Reducing and Accelerating         | Type A and Type C Admixture Properties  |
|                      | F     | High Range Water-Reducing               | Increases Workability (More Effective than Type A), Air Content, Early-Age Strength, and Ultimate Strength; Decreases Water Demand (12 – 40%, > 6 in. Slump) and Permeability               |
|                      | G     | High Range Water-Reducing and Retarding | Type F and Type B Admixture Properties  |
|                      | S-SRA | Shrinkage Reducing                      | Increases Setting Time; Decreases Drying Shrinkage Cracking and Bleed Rate  |
|                      | S-CRA | Crack Reducing                          | Decreases Cracking (More Effective than SRAs) and Crack Width   |
| M 154                | AEA   | Air-Entraining                          | Increases Cohesion, Workability, Stabilization of Air Bubbles, Resistance to Freezing, Thawing, and De-icing, Resistance to Alkali-Reactive Environment, and Resistance to Sulfate Reaction |
| M 194 <sup>[1]</sup> | MRWRA | Mid Range Water-Reducing                | Type A and Type F Admixture Properties; Increases Workability (Especially Concrete with SCMs); Decreases Water Demand (6 – 12 %, 5 – 8 in. Slump)   |
| C1622                | CWA   | Cold Weather                            | Increases Hydration Rate; Decreases Freezing Point of Mixing Water  |

<sup>[1]</sup> Mid range water-reducing admixtures (MRWRA) may meet either water-reducing (A) or high range water-reducing (F) admixture criteria.

**5. Paste Content.**

The paste content for the mix design may be optimized to enhance potential properties of the concrete, including workability, strength, permeability, and resistance to drying shrinkage and cracking and volume change from wetting and drying. The volume of paste should adequately fill the voids and provide sufficient separation between the aggregate particles to promote workability and effective bonding of particles.

**Table 701.30-8: Paste Content**

| Mix Design Characteristic                                    | Recommendation      |
|--|---------------------|
| Volume of Cement Concrete (cf) <sup>[1]</sup>                | 27                  |
| Paste Content (%) <sup>[2]</sup>                             | ≤ 28 <sup>[3]</sup> |
| Paste Content to Aggregate Void Content Ratio <sup>[4]</sup> | 1.25 – 1.75         |
| Excess Volume of Paste for Workability (%) <sup>[5]</sup>    | –                   |

<sup>[1]</sup> The volume of cement concrete is determined by the following equation, where W = Weight (lbs.), SG = Specific Gravity, D = Density (pcf), and V = Volume (cf).

$$V_{CEMENT} = W_{CEMENT} / SG_{CEMENT} * D_{WATER}$$

$$V_{SCM} = W_{SCM} / SG_{SCM} * D_{WATER}$$

$$V_{ADMIXTURE} = V_{ADMIXTURE} \text{ in oz.} / 957.5 \text{ oz. per cf}$$

$$V_{WATER} = V_{WATER} \text{ in gal.} / 7.48 \text{ gal. per cf}$$

$$V_{COARSE} = W_{COARSE} / SG_{COARSE} * D_{WATER}$$

$$V_{FINE} = W_{FINE} / SG_{FINE} * D_{WATER}$$

$$V_{CONCRETE} = V_{CEMENT} + V_{SCM} + V_{ADMIXTURE} + V_{WATER} + V_{COARSE} + V_{FINE} + V_{AIR}$$

<sup>[2]</sup> The paste content by volume of cement concrete is determined by the following equation, where V = Volume (cf) and PC = Paste Content (%).

$$V_{PASTE} = V_{CEMENT} + V_{SCM} + V_{ADMIXTURE} + V_{WATER}$$

$$PC_{CONCRETE} = V_{PASTE} / V_{CONCRETE}$$

<sup>[3]</sup> The cracking tendency of structural concrete is significantly reduced when the paste content by volume is less than or equal to 28 percent.

<sup>[4]</sup> The paste content to aggregate void content ratio is determined by the following equation, where D = Density (pcf), SG = Specific Gravity, BD = Bulk Density (pcf), VC = Void Content (%), V = Volume (cf), AVC = Aggregate Void Content (%), PC = Paste Content (%), and R = Ratio. Workability increases as the paste content to aggregate void content ratio increases. Decreased paste content to aggregate void content ratios will result in decreased workability, where water-reducing admixtures provide no benefit.

$$V_{COARSE} = SG_{COARSE} * D_{WATER} - BD_{COARSE} / D_{COARSE}$$

$$V_{FINE} = SG_{FINE} * D_{WATER} - BD_{FINE} / D_{FINE}$$

$$V_{AGGREGATE} = [(V_{COARSE} / (V_{COARSE} + V_{FINE})) * VC_{COARSE} + (V_{FINE} / (V_{COARSE} + V_{FINE})) * VC_{FINE}]$$

$$AVC_{CONCRETE} = [V_{AGGREGATE} * ((V_{COARSE} + V_{FINE}) / V_{CONCRETE})]$$

$$R_{PC-AVC} = PC_{CONCRETE} / AVC_{CONCRETE}$$

<sup>[5]</sup> The excess paste content for workability is determined by the following equation, where PC = Paste Content (%), AC = Air Content (%), AVC = Aggregate Void Content (%), and EPC = Excess Paste Content for Workability (%).

$$EPC_{CONCRETE} = PC_{CONCRETE} + AC_{CONCRETE} - AVC_{CONCRETE}$$

### C. Initial Curing Materials.

The materials and procedures used for initial curing methods of cement concrete shall meet the Manufacturer's instructions and recommendations and the requirements specified herein.

Cement concrete with a low to negligible bleeding rate, exposure to highly evaporative environments, high content of silica fume, fine cement, or other fine cementitious material, low water to cementitious ratio, high air content, or water-reducing admixtures have an increased susceptibility to surface drying and plastic shrinkage between placement and finishing operations. Initial curing materials and procedures shall be applied immediately after the bleed water sheen has disappeared from the surface of the concrete or the concrete surface exhibits loss of moisture and surface drying, between placement and finishing operations. Initial curing materials shall not be worked into the surface in subsequent finishing operations.

#### 1. Liquid-Applied Evaporation Reducers.

Liquid-applied evaporation reducers used for initial curing methods shall produce an effective monomolecular film over the bleed water layer, to reduce the rate of evaporation of the bleed water from the surface and plastic shrinkage when the evaporation rate equals or exceeds the bleeding rate.

### D. Intermediate Curing Materials.

The materials and procedures used for intermediate curing methods of cement concrete shall meet the Manufacturer's instructions and recommendations and the requirements specified herein.

In instances where finishing operations have been completed prior to the concrete achieving final set and the concrete surface exhibits loss of moisture and surface drying, the following curing materials and procedures shall be applied immediately to the concrete surface prior to the application of final curing materials, to prevent the loss of moisture without damaging the concrete surface, until final set of the concrete has been achieved and final curing materials have been applied to the concrete surface.

- 701.30.C.1: Liquid-Applied Evaporation Reducers
- 701.30.E.3.a: Liquid Membrane-Forming Compounds for Curing
- 701.30.E.3.b: Liquid Membrane-Forming Compounds for Curing and Sealing

### E. Final Curing Materials.

The materials and procedures used for final curing methods of cement concrete shall meet the Manufacturer's instructions and recommendations and the requirements specified herein.

Curing water shall be free of deleterious impurities, causing staining and deterioration. The potential staining ability of curing water shall be evaluated by means of CRD-C401 (US Army Corps

of Engineers 1975) for instances where curing water quality is questioned. Curing water shall not exceed a temperature differential of more than 20°F from the internal concrete temperature, to prevent cracking due to temperature gradients causing strain that exceeds the strain capacity of concrete. Curing water shall remain above freezing temperatures throughout the duration of the curing cycle.

Final curing materials and procedures shall be applied to the concrete surface immediately after application of initial and intermediate curing materials, finishing operations, and final set of cement concrete, to prevent the loss of moisture and surface drying.

Materials used for final curing methods of cement concrete shall accommodate all exposed cement concrete surfaces with a continuous application of moisture throughout the entire duration of the final curing method cycle and provide controlled and gradual termination of the final curing method cycle.

Final curing materials applied to the concrete shall allow the concrete to mature sufficiently to achieve its designed and desired properties, including strength, volume stability, permeability, durability, and resistance to freezing, thawing, and de-icing cycles. Insufficient application of final curing materials results in decreased strength and durability of the top surface of concrete.

Protection to the concrete surface and curing materials shall be required in instances where adverse weather conditions are present, until curing operations can be initiated without damaging the surface of the concrete.

Final curing materials and procedures shall be applied to the concrete surface throughout the entire duration of the curing cycle and meet minimum sustained temperature, duration, and strength requirements, as specified in applicable Division II: Construction Details and herein. Controlled and gradual termination of the final curing method cycle shall begin only after all specified conditions are met, until the concrete gradually cools to within 20°F of the ambient temperature.

### **1. Saturated Covers.**

Saturated covers used for final curing methods shall meet AASHTO M 182, Class 3. Saturated covers shall be in good condition, free from holes, tears, or other defects that would render it unsuitable for curing cement concrete and cementitious materials. Saturated covers shall be dried to prevent mildew when storing. Prior to application, saturated covers shall be thoroughly rinsed in water and free of harmful substances that are deleterious or cause discoloration to cement concrete and cementitious materials. Saturated covers shall have sufficient thickness and proper positioning onto the surface to maximize moisture retention. Saturated covers shall contain a sufficient amount of moisture to prevent moisture loss from the surface of cement concrete and cementitious materials. Saturated covers shall have the ability to retain sufficient moisture from continuous watering so that a film of water remains on the surface of cement concrete and cementitious materials throughout the entire duration of the final curing method cycle. Saturated covers shall not absorb water from cement concrete and cementitious materials. Polyethylene film may be applied over the saturated cover to limit the amount of continuous watering required for sufficient moisture retainage. Saturated covers shall accommodate uniform and slow drying of cement concrete and cementitious materials surfaces immediately prior to removal.

## **2. Sheet Materials.**

Sheet materials, including polyethylene film, white burlap-polyethylene sheeting, and reinforced paper, used for final curing methods shall meet ASTM C171 and the requirements specified herein. Sheet materials shall inhibit moisture loss and reduce temperature rise in concrete exposed to radiation from the sun during the final curing method cycle. Adjoining covers shall overlap not less than 12 inches. All edges of the sheet materials shall be secured to maintain a moist environment.

### **a. Polyethylene Film.**

Polyethylene film shall be clear, white, or black in color and consist of a single sheet manufactured from polyethylene resins, be free of visible defects, including tears, wrinkles, and discontinuity. The film shall prohibit mottling and uneven spots from appearing on the surface of concrete, due to variations in temperature, moisture content, or both. Application of additional curing water under the film or application of a polyethylene film bonded to absorbent fabric to the concrete surface may be required to prevent mottling and to retain and evenly distribute the moisture. Polyethylene film shall accommodate concrete surfaces with constant contact without damage. The film shall be sufficient in length to extend beyond the edges of the concrete surface. Edges of adjacent polyethylene film shall overlap a minimum of 6 inches and be tightly sealed with the use of sand, wood planks, pressure-sensitive tape, mastic, or glue to maintain close contact with the concrete surface, retain moisture, and prevent the formation of air pockets throughout the entire duration of the final curing method cycle.

#### **i. White Polyethylene Film.**

White polyethylene film shall minimize heat gain caused by absorption of solar radiation and shall be exclusively used during warm weather applications.

#### **ii. Clear and Black Polyethylene Films.**

Clear and black polyethylene films shall inhibit absorption of solar radiation for cold weather applications.

### **b. White Burlap-Polyethylene Sheeting.**

White burlap-polyethylene sheeting shall be securely bonded to the burlap so to avoid separation of the materials during handling and curing of the concrete.

### **c. Reinforced Impervious Paper.**

Reinforced impervious paper shall be white in color, consist of two sheets of kraft paper cemented together with a bituminous adhesive, and reinforced with embedded cords or strands of fiber running in both directions. Reinforced impervious paper shall be free of holes, tears, and pin holes from deterioration of the paper through repeated use. Reinforced impervious paper shall be treated to prevent tearing when wetted and dried. Reuse of reinforced impervious paper shall be permitted so long as it is able to retain moisture on the surface of concrete. The paper shall be discarded and prohibited from use when moisture is no longer retained in the material.

## **3. Liquid Membrane-Forming Compounds.**

Compounds shall form a continuous, non-yellowing, and durable film with quality moisture-retention properties. Compounds shall maintain the relative humidity of the concrete surface



above 80% for seven days to sustain cement hydration. Compounds shall not affect the original color of the concrete surface. Compounds shall not degrade due to exposure to ultraviolet light from direct sunlight. Compounds shall meet the local and federal allowable Volatile Organic Compound (VOC) content limits.

White-pigmented compounds shall be used in instances where solar-heat gain is concern to the concrete surface. White-pigmented compounds shall be agitated in the container prior to application to prevent pigment from settling out resulting in non-uniform overage and ineffective curing.

Careful considerations shall be made by the Contractor to determine if the evaporation rate is exceeding the rate of bleeding, thus causing the surface to appear dry even though bleeding is still occurring. To diagnose and prevent this condition, the Contractor may place a transparent plastic sheet over a test area of the uncured and unfinished concrete surface and shall determine if any bleed water accumulates under the plastic. Under such conditions, the application of liquid membrane-forming compounds to the concrete surface shall be delayed to prevent bleed water from being sealed below the concrete surface, map cracking of the membrane films, reduction in moisture-retention capability, and the need for reapplication of the compound.

Prior to use, compounds shall be thoroughly mixed, stirred, and agitated per the Manufacturer's instructions and recommendations.

Compounds shall be applied continuously and uniformly to the surface of the concrete per the Manufacturer's instructions and recommendations. Compounds shall be applied immediately after the disappearance of the surface water sheen following final finishing. Applying of the compound immediately after final finishing and before all free water on the surface has evaporated will help prevent the formation of cracks. When using compounds to reduce moisture loss from formed surfaces, the exposed surface shall be wetted immediately after form removal and kept moist until the curing compound is applied. The concrete shall be allowed to reach a uniformly damp appearance with no free water on the surface, and then application of the compound shall begin at once. Delayed application will result in surface drying, absorption of the compound into the concrete, and no forming of a continuous membrane.

The concrete surface shall be damp when the compound is applied. Power-driven spray equipment shall be used for uniform application of compounds on large paving projects. Spray nozzles recommended by the compound Manufacturer and use of windshields shall be arranged by the Contractor to prevent wind-blown loss of compound and to ensure proper coverage application rates are achieved. The compound shall be applied by power sprayer, using appropriate wands and nozzles with pressures between 25 and 100 psi. The Contractor shall fill the power sprayer with curing compound from the Manufacturer's original container in the presence of the Engineer. Any dilution as recommended by the Manufacturer shall take place in the presence of the Engineer. For very small areas such as repairs, the compound shall be applied with a wide, soft-bristled brush or paint roller.

The Contractor shall verify the application rate and procedures are in accordance with the Manufacturer's instructions and recommendations. At least one uniform coat shall be applied at a rate of 150 to 200 ft<sup>2</sup>/gallon. On very deeply textured surfaces, the surface area to be treated shall be at least twice the surface area of the surface. In such cases, two separate applications may be needed, each at 200 ft<sup>2</sup>/gallon or greater if specified by the Manufacturer to achieve the desired

moisture retention rate, with the first being allowed to become tacky before the second is applied. If two coats are necessary to ensure complete coverage, for effective protection the second coat should be applied at right angles to the first. Complete coverage of the surface shall be attained due to the potential for formation of small pinholes in the membrane, which will result in loss of moisture from the concrete. Compounds shall not sag, run off peaks, or collect in grooves.

Compounds and procedures shall be compatible with concrete surfaces receiving subsequent applications or placements of concrete, overlays, coatings, paints, sealers, finishes or other toppings to ensure acceptable bonding to the concrete. Testing to establish compatibility among the curing compound, subsequent surface treatments, concrete moisture content and the actual finished surface texture of the concrete shall be conducted when compatibility is not known. The compound Manufacturer shall be consulted by the Contractor to determine the compatibility of the application. Compounds shall not be applied to concrete surfaces where bonding of subsequent applications or placements is incompatible or is of concern. The use of wax-based curing compounds shall be prohibited in instances where concrete surfaces are subject to additional toppings and vehicular, pedestrian, or other traffic. Deliberate removal of compounds in the presence of the Engineer and in accordance with Manufacturer's instructions and recommendations shall be conducted as an alternative to compatibility testing, incompatibility, or in instances where bonding is of concern. Bonding of subsequent materials may still be inhibited by the presence of the compound even after the moisture retention characteristics of the compound have diminished.

**a. Liquid Membrane-Forming Compounds for Curing.**

Liquid membrane-forming compounds for curing shall meet ASTM C309, the Manufacturer's instructions and recommendations, and the requirements specified herein.

***Table 701.30-1: Types of Compounds for Curing***

| Type     | Description                            |
|----------|--|
| Type 1   | Clear or translucent without dye       |
| Type 1-D | Clear or translucent with fugitive dye |
| Type 2   | White pigmented                        |

***Table 701.30-2: Composition Class of Compounds for Curing***

| Type    | Description  |
|---------|--|
| Class A | Unrestricted composition, generally wax-based products |
| Class B | ASTM D883 resin-based products                         |

**b. Liquid Membrane-Forming Compounds for Curing and Sealing.**

Liquid membrane-forming compounds for curing and sealing shall meet ASTM C 1315, the Manufacturer's instructions and recommendations, and the requirements specified herein.

In addition to moisture-retention capabilities compounds shall exhibit specific properties, including alkali resistance, acid resistance, adhesion-promoting quality, and resistance to degradation by ultraviolet light.

**Table 701.30-3: Types of Compounds for Curing and Sealing**

| Type    | Description          |
|---------|----------------------|
| Type I  | Clear or translucent |
| Type II | White pigmented      |

**Table 701.30-4: Class of Compounds for Curing and Sealing**

| Type    | Description   |
|---------|---------------|
| Class A | Non-yellowing |

**F. Protective Sealing Compounds.**

Protective sealing compounds shall maintain valid listing on the Department Qualified Construction Materials List (QCML) and meet AASHTO M 224, NCHRP Report 244 and the requirements specified herein.

Protective sealing compounds shall sufficiently penetrate the concrete to seal the surface pores and fill the capillaries of the concrete by chemically reacting with the concrete and forming a hydrophobic layer. Protective sealing compounds shall limit the penetration of liquids, gases, and harmful substances into hardened concrete, including water, de-icing agents, and carbon dioxide to protect concrete from freezing, thawing, and de-icing cycles, corrosion of reinforcing steel, and acid attack. Protective sealing compounds shall limit the buildup of vapor pressure between the concrete and the applied sealer. Protective sealing compounds shall retard the penetration of harmful substances into hardened concrete. Protective sealing compounds shall maintain their protective properties during environmental exposure to freezing, thawing, and de-icing cycles. Protective sealing compounds shall not reduce the frictional properties of the concrete. Protective sealing compounds shall not affect the original color of the concrete surface if maintaining the original color is desired by the Department. Protective sealers shall meet the local and federal allowable Volatile Organic Compound (VOC) content limits.

Curing methods conforming to Department specifications shall be applied to the concrete prior to the application of protective sealers. Protective sealers shall not be applied to the concrete for a minimum of 28 days after placement and the surface shall be sufficiently prepared, clean, and dry for at least 24 hours with ambient temperatures exceeding 60°F. Protective sealers shall not be applied to concrete placed where freezing, thawing, and de-icing cycles are expected immediately after, due to the retainage of water in the concrete. Periodic re-application shall be required for protective penetrants requiring multiple applications and for concrete surfaces exhibiting wear to ensure long-term protection of the concrete surface.

**G. Cold Weather Concreting Materials.**

Cold weather concreting shall be defined as the procedures, operations, materials, and equipment required for the mixing, delivery, placement, finishing, curing, and protection of concrete during cold weather conditions, while exposed to air temperatures falling below, or expected to fall below 40°F.

The protection period shall be defined as the minimum duration required to prevent concrete from the negative effects of cold weather exposure. The protection period shall remain in place while

cold weather conditions exist. Controlled and gradual termination of the protection period shall be conducted only after 100% f'c is attained and all specified conditions are met.

The procedures, operations, materials, and equipment selected for cold weather concreting shall adequately maintain specified temperature ranges by addressing all variables, including ambient weather conditions, geometry of the structure, and mix design proportions. Concrete temperatures for cold weather concreting shall meet Table 701.30-5.

**Table 701.30-5: Concrete Temperature Requirements for Cold Weather Concreting**

| Phase   | Cold Weather Temperature (°F) | Concrete Temperature (°F) |
|---|-------------------------------|---------------------------|
| Mixing  | 30-39                         | 60-75                     |
|   | 0-30                          | 65-80                     |
|   | < 0                           | 70-85                     |
| Placement   | < 40                          | 55-75                     |
| Protection Period   | < 40                          | 55-75                     |
| Termination of Protection Period – Allowable Rate of Decrease in 24 Hours | < 40                          | ≤ 50                      |

Cold weather concreting procedures, operations, materials, and equipment shall be developed and performed to prevent damage to concrete due to freezing at early ages, to ensure that the concrete develops the recommended strength for safe removal of forms, to maintain curing conditions that promote quality strength and durability development, to limit rapid temperature fluctuation, and to provide protection consistent with intended serviceability of the structure. The Contractor shall develop and submit to the Department for review and approval, cold weather concreting procedures for the mixing, delivery, placement, finishing, curing, and protection of concrete during cold weather, including:

- Procedures for protecting the subgrade from frost and the accumulation of ice or snow on reinforcement or forms prior to placement
- Methods and requirements for cold weather protection and temperature control of constituent materials incorporated into the mix design
- Chemical admixtures incorporated into the mix design for cold weather protection and temperature control
- Methods and requirements for cold weather protection and temperature control during mixing, delivery, placement, finishing, curing, and protection period
- Curing methods to be used during and following the protection period
- Types of covering, insulation, heating, or enclosures to be provided
- Methods for verification of in-place strength
- Procedures for measuring and recording concrete temperatures
- Procedures for preventing drying during dry, windy conditions

All procedures, operations, materials, and equipment required for adequate protection and curing shall be present and ready for use prior to concrete production.

## **1. Insulating Materials.**

Insulating materials used for cold weather concreting shall meet the requirements specified herein. The thermal resistance of the proposed insulation system shall be determined to meet the concrete temperature range requirements specified herein. Supplemental heat, including hydronic heating systems, shall be applied in instances where insulating materials cannot achieve the concrete temperature requirements.

## **2. Heaters.**

Heaters used for cold weather concreting including direct fired, indirect fired, and hydronic heaters shall meet ANSI A10.10 carbon monoxide limits, safety regulations for ventilation, and the stability, operation, fueling, and maintenance of heaters and the requirements specified herein.

### **a. Direct Fired Heaters.**

Direct fired heaters generate heat to an enclosed space through the combustion of fossil fuels, including oil, kerosene, propane, gasoline, and natural gas. Hot air comprised of carbon dioxide and carbon monoxide combustion products, is discharged into the enclosed space. Direct fired heaters shall be prohibited from heating the air directly surrounding the concrete surface due to calcium carbonate formation interfering with the hydration reaction, from the reaction between the carbon dioxide generated from the combustion of fossil fuels and the calcium hydroxide on the surface of freshly placed concrete, resulting in a soft, chalky, and nondurable concrete surface. Direct fired heaters shall only be used on concrete surfaces protected from fossil fuel combustion products.

### **b. Indirect Fired Heaters.**

Indirect fired heaters generate heat to an enclosed space through the combustion of fossil fuels, including oil, kerosene, propane, gasoline, and natural gas. The carbon dioxide and carbon monoxide combustion products are expelled through venting, resulting in clean heated air discharged into the enclosed space. Indirect fired heaters are suitable for heating the air directly surrounding the concrete surface.

### **c. Hydronic Heaters.**

Hydronic heaters generate heat to an enclosed space through the circulation of the heat-transfer fluid in a closed system of pipes or hoses. The heat-transfer fluid is comprised of a propylene glycol water solution and is heated through the combustion of fossil fuels, including diesel fuel and kerosene. The combustion of fossil fuel occurs outside of the enclosed space and does not expose the concrete surface to the deleterious effects of carbon dioxide.

After the concrete placement achieves final set, polyethylene film or other suitable material shall sufficiently serve as a vapor barrier. The heat-transfer hoses shall be placed on top of the vapor barrier and covered with insulating materials meeting 701.30.G.1. Hydronic heaters shall be used to thaw or preheat subgrades prior to concrete placement and provide supplementary heat to insulating materials. Hydronic heaters shall provide an even distribution of heat to prevent curling and cracking induced by temperature gradients within concrete.

### 3. Enclosures.

Enclosures shall be made of wood, canvas tarpaulins, polyethylene film, or prefabricated rigid plastic. Enclosures shall be airtight, block wind, prevent admittance of cold air, conserve heat, and withstand wind and snow loads. Enclosures shall provide adequate headroom for craftsmen and sufficient space between the concrete and the enclosure to permit free circulation of warm air. Supplementary heat shall be supplied to enclosures by hydronic heaters, live steam, hot forced air, or indirect fired combustion heaters. Icing along the perimeter of the enclosure shall be prevented when live steam is utilized. Heaters and ducts shall be positioned to prevent the hot, dry air from overheating or drying the concrete surface. Insulating materials meeting 701.30.G.1 shall be applied as a vapor barrier to the concrete surface immediate after final set is attained.

#### H. Hot Weather Concreting Materials.

Hot weather concreting shall be defined as the procedures, operations, materials, and equipment required for the mixing, delivery, placement, finishing, bleed water evaporation, curing, and protection of concrete during hot weather conditions, while exposed to air temperatures exceeding, or expected to exceed 80°F; concrete temperatures approaching, or expected to approach 90°F; evaporation rates of surface water approaching, or expected to approach the bleeding rate of the concrete; high solar radiation; low relative humidity; and high wind speed.

The protection period shall be defined as the minimum duration required to prevent concrete from the negative effects of hot weather exposure, including the acceleration of rate of moisture loss and rate of cement hydration, difficulties in curing, increased concrete temperature, increased water demand, accelerated slump loss, increased rate of setting, increased tendency for plastic shrinkage and thermal cracking, increased potential for cold joints, and difficulties in controlling entrained air content. The protection period shall remain in place while hot weather conditions exist. Controlled and gradual termination of the protection period shall be conducted when conditions permit. The allowable rate of temperature decrease shall not exceed 5°F per hour and meet the allowable rate of temperature decrease specified in 701.30.G: Cold Weather Concreting Materials.

The procedures, operations, materials, and equipment selected for hot weather concreting shall adequately maintain specified temperature ranges and evaporation rates by addressing all variables, including ambient weather conditions, geometry of the structure, and mix design proportions. Initial materials meeting 701.30.C: Initial Curing Materials shall be applied to the concrete surface while the concrete and air temperatures, relative humidity of the air, and the wind speed have the capacity to evaporate free water from the fresh concrete surface at a rate that is equal to or greater than bleeding rate of the concrete. The evaporation rate of surface water shall be determined by the following equation:

$$E = (T_c^{2.5} - r * T_a^{2.5})(1 + 0.4V) \times 10^{-6}$$

where E = evaporation rate of water-covered surface (lb/ft<sup>2</sup>/hr), T<sub>c</sub> = concrete temperature of the evaporating surface (°F), r = relative humidity of air surrounding the evaporating surface (%), T<sub>a</sub> = temperature of the air surrounding the evaporative surface (°F), and V = average wind speed 20 inches above the evaporating surface. The air surrounding the evaporating surface shall be defined as the air approximately 4 to 6 feet above the evaporating surface on the windward side and shielded from the sun's rays.

Hot weather concreting procedures, operations, materials, and equipment shall be developed and performed to prevent damage to concrete and promote long-term durability. The Contractor shall develop and submit to the Department for review and approval, hot weather concreting procedures for the mixing, delivery, placement, finishing, curing, and protection of concrete during hot weather, including:

- Procedures for preparing the subgrade prior to placement
- Methods and requirements for hot weather protection and temperature control of constituent materials incorporated into the mix design
- Chemical admixtures incorporated into the mix design for hot weather protection and temperature control
- Methods and requirements for hot weather protection and temperature control during mixing, delivery, placement, finishing, curing, and protection period
- Initial curing methods to be used to reduce surface evaporation
- Curing methods to be used during and following the protection period
- Types of covering, insulation, cooling, or enclosures to be provided
- Evaporation rate and bleeding rate of concrete calculations
- Procedures for measuring and recording concrete temperatures
- Procedures for preventing drying during dry, windy conditions

All procedures, operations, materials, and equipment required for adequate protection and curing shall be present and ready for use prior to concrete production.

## **CONSTRUCTION METHODS**

### **701.40: Pre-Placement**

#### **A. Excavation.**

Excavation of the area shall be in accordance with the applicable portions of Subsection 120: Excavation.

#### **B. Subgrade and Subbase.**

The subgrade for the sidewalks and driveways shall be shaped parallel to the proposed surface of the sidewalks and driveways and thoroughly compacted. All depressions in the subgrade shall be filled with suitable material and again compacted until the surface is smooth and hard. Prior to the placement of the subbase, the Contractor shall inspect the prepared subgrade to ensure that it is in conformance with the required grade and cross-section. Subgrade shall be fine graded to meet the applicable requirements of Subsection 170: Grading.

After the subgrade has been prepared, a gravel subbase shall be placed upon it. After being compacted thoroughly, the subbase shall be at least 8 inches thick and parallel to the proposed surface of the sidewalk. Prior to the placement of the cement concrete, the Contractor shall inspect the prepared subbase material to ensure that it is in conformance with the required grade and cross-section. Subbase material that is not in accordance with the plans or specifications shall be reworked or replaced to meet the applicable requirements of Subsection 170: Grading before the start of cement concrete placement. When placing cement concrete, the compacted subbase shall not be frozen or have standing water.

### C. Forms.

Side forms and transverse forms shall be smooth, free from warp, of sufficient strength to resist springing out of shape, of a depth to conform to the thickness of the proposed sidewalk or pedestrian curb ramp and of a type satisfactory to the Engineer.

All mortar or dirt from previously used forms shall be completely removed prior to use. The forms shall be well staked and thoroughly graded and set to the established lines with their upper edge conforming to the grade of the finished sidewalk or pedestrian curb ramp which shall have sufficient pitch to the roadside edge to provide for surface drainage.

All pedestrian curb ramp joints and transition sections which define grade changes shall be formed staked and checked for dimension, grade and slope conformance prior to placing cement concrete.

All forms shall be oiled before placing concrete.

#### 701.41: Placement

The concrete shall be placed in alternate slabs 30 ft long except as otherwise ordered. The slabs shall be separated by transverse preformed expansion joint filler ½ in. thick.

Preformed expansion joint filler shall be placed adjacent to or around existing structures as directed.

Detectable warning panels conforming to the plans shall be securely incorporated into the work by means acceptable to the Engineer.

On the foundation as specified above, the concrete shall be placed in such quantity that after being thoroughly consolidated in place it shall be 4 in. deep. At driveways, the sidewalks shall be 6 in. deep.

In conveying the concrete from the place of mixing to the place of deposit, the operation shall be conducted in such a manner that no mortar will be lost, and the concrete shall be so handled that the concrete will be of uniform composition throughout, showing neither excess nor lack of mortar in any one place.

The surface of all concrete sidewalks shall be uniformly scored into block units of areas not more than 36 ft<sup>2</sup>. The depth of the scoring shall be at least ½ in. deep and no more than ½ in. wide.

#### 701.42: Initial Curing

In instances where the bleed water sheen has disappeared from the surface of the concrete or the concrete surface exhibits loss of moisture and surface drying between placement and finishing operations, the Contractor shall apply one of the following initial curing materials and procedures meeting 701.30.C: Initial Curing Materials until finishing operations occur.

- 701.30.C.1: Liquid-Applied Evaporation Reducers

Initial curing materials shall not be worked into the surface in subsequent finishing operations.



**701.43: Finishing**

The finishing of concrete surface shall be done by experienced and competent cement finishers. No finishing operation shall be performed while free water is present. Finishing operations shall be delayed until all bleed water and water sheen has left the surface and the concrete has started to stiffen. After water sheen has disappeared, edging operations, where required, shall be completed. After edging and joining operations, the surface shall be floated. Magnesium floats shall be used for all finishing operations. If necessary tooled joints and edges shall be rerun before and after floating to maintain uniformity. After floating, the surface shall be brushed by drawing a soft-bristled push broom with a long handle over the surface of the concrete to produce a nonslip surface.

**701.44: Intermediate Curing**

In instances where finishing operations have been completed prior to the concrete achieving final set and the concrete surface exhibits loss of moisture and surface drying, the Contractor shall apply one of the following intermediate curing materials and procedures meeting 701.30.D: Intermediate Curing Materials immediately to the concrete surface prior to the application of final curing materials, to prevent the loss of moisture without damaging the concrete surface, until final set of the concrete has been achieved and final curing materials have been applied to the concrete surface.

- 701.30.C.1: Liquid-Applied Evaporation Reducers
- 701.30.E.3.a: Liquid Membrane-Forming Compounds for Curing
- 701.30.E.3.b: Liquid Membrane-Forming Compounds for Curing and Sealing

**701.45: Final Curing**

The Contractor shall apply one of the following final curing materials and procedures meeting 701.30.E: Final Curing Materials to the concrete surface immediately after application of initial and intermediate curing materials, finishing operations, and final set of cement concrete, to prevent the loss of moisture and surface drying.

- 701.30.E.1: Saturated Covers
- 701.30.E.2: Sheet Materials
- 701.30.E.3.a: Liquid Membrane-Forming Compounds for Curing
- 701.30.E.3.b: Liquid Membrane-Forming Compounds for Curing and Sealing

The Contractor shall apply final curing materials and procedures to the concrete surface throughout the entire duration of the curing cycle and meet minimum sustained temperature, duration, and strength requirements, as specified in in Table 701.45-1. Controlled and gradual termination of the curing cycle shall begin after all specified conditions are met.

***Table 701.45-1: Termination of Curing Cycle***

| Sustained Concrete Temperature | Final Curing Cycle Duration | Compressive Strength <sup>[1]</sup> |
|--------------------------------|-----------------------------|-------------------------------------|
| 50°F ≤ °F ≤ 90°F               | ≥ Seven (7) days            | ≥ 70% f <sub>c</sub>                |

<sup>[1]</sup> Compressive strength cylinders for termination of curing cycle shall be cast and field cured with the same environmental conditions that the sidewalk is subjected to throughout the entire duration of the final curing cycle, per 701.73: Acceptance Sampling and Testing.

**701.46: Protective Sealing**

The Contractor shall apply sealing materials and procedures meeting 701.30.F: Protective Sealing Compounds only if one or more of the following final curing materials and procedures were applied:

- 701.30.E.1: Saturated Covers
- 701.30.E.2: Sheet Materials
- 701.30.E.3.a: Liquid Membrane-Forming Compounds for Curing

Protective sealing compounds shall not be applied to concrete surfaces applied with a final curing material and procedure meeting 701.30.E.3.b: Liquid Membrane-Forming Compounds for Curing and Sealing.

**701.47: Cold Weather Concreting**

The Contractor shall conduct cold weather concreting procedures, operations, materials, and equipment required for the mixing, delivery, placement, finishing, curing, and protection of concrete, while surfaces are exposed to air temperatures falling below, or expected to fall below 40°F in accordance with 701.30.G: Cold Weather Concreting Materials. All procedures, operations, materials, and equipment required for adequate protection and curing shall be present and ready for use prior to concrete production.

**701.48: Hot Weather Concreting**

The Contractor shall conduct hot weather concreting procedures, operations, materials, and equipment required for the mixing, delivery, placement, finishing, curing, and protection of concrete, while surfaces are exposed to air temperatures exceeding, or expected to exceed 80°F; concrete temperatures approaching, or expected to approach 90°F; evaporation rates of surface water approaching, or expected to approach the bleeding rate of the concrete; high solar radiation; low relative humidity; and high wind speed in accordance with 701.30.H: Hot Weather Concreting Materials. All procedures, operations, materials, and equipment required for adequate protection and curing shall be present and ready for use prior to concrete production

**CONTRACTOR QUALITY CONTROL****701.60: General**

The Contractor shall provide adequate Quality Control (QC) to ensure that all materials and workmanship conform with the specification requirements. The Contractor shall perform QC activities as outlined further below.

**701.61: Contractor Quality Control Plan**

The Contractor shall provide and maintain a Quality Control Plan (QC Plan). The QC Plan should sufficiently document the QC processes of all Contractor parties (i.e. Prime Contractor, Subcontractors, Producers) performing work required under this specification.

**701.62: Production Personnel**

**A. Foreman.**

A foreman shall be present throughout the entire duration of the construction operation with at least one of the following personnel certifications.

- NRMCA Concrete Exterior Finisher Certification
- ACI Concrete Flatwork Technician and Flatwork Finisher

The foreman is responsible for the oversight of the construction operation per the requirements specified in Table 701.62-1.

*Table 701.62-1: Minimum Foreman Activities*

| Operation | Foreman | Activity   |
|-----------|---------|--|
| Oversight | One (1) | Review and compare batch ticket quantities and sources to approved mix design        |
|           |         | Monitors conformance to AASHTO M 157 Standard Specification for Ready-Mixed Concrete |
|           |         | Monitors conformance to Department specifications                                    |
|           |         | Monitors Production Personnel activities   |
|           |         | Verifies proper equipment is on hand prior to start of construction                  |
|           |         | Monitors equipment, environmental conditions, materials, and workmanship             |
|           |         | Prohibits the use of prohibited equipment and practices                              |
|           |         | Acknowledges sampling, testing, and inspection results                               |

**B. Operators.**

Concrete sidewalk shall be constructed by sufficiently staffed, trained, experienced, and qualified equipment operators and craftsmen, who are presently involved in sidewalk construction, throughout the entire duration of the construction operation, per the requirements specified in Table 701.62-2.

**Table 701.62-2: Minimum Operator Activities**

| <b>Operation</b>   | <b>Operators<sup>[1]</sup></b>                            | <b>Activity</b>  |
|--|---|--|
| 701.40:<br>Pre-Placement   | Two (2)   | Apply sufficient base compaction   |
|  |   | Moisten sub-base, free of standing water   |
|  |   | Secure forms, straight and level   |
|  |   | Mark expansion locations   |
|  |   | Prohibited Practices: Placement on frozen sub-grade  |
| 701.41:<br>Placement<br>(Concrete<br>Discharging)  | Two (2)   | Direct concrete trucks   |
|  |   | Handle chute discharge and truck movement  |
|  |   | Assist in preparing concrete for testing   |
|  |   | Direct trucks to washout area  |
|  |   | Provide general help   |
|  |   | Prohibited Practices: Adding constituent materials not in conformance with AASHTO M 157 or without Department consent                    |
| 701.41:<br>Placement   | Two (2)   | Localize placement to minimize moving material   |
|  |   | Level concrete in front of the screed  |
|  |   | Operate come-alongs or flat headed shovel to move concrete in form   |
|  |   | Consolidate concrete along form edge to avoid honeycombing   |
|  |   | Operate screed over top of forms in sawing action for surface leveling   |
|  |   | Operate magnesium bull float to push coarse aggregate below the surface and fill in the low spots or depressions                         |
|  |   | Prohibited Practices: Toothed raking, dragging of internal vibrator, and internal vibrator to move concrete; steel troweling or floating |
| 701.42:<br>Initial Curing  | Apply an initial curing material and procedure per 701.42 |  |
|  | One (1)   | 701.30.C.1: Liquid-Applied Evaporation Reducers  |
| 701.43:<br>Finishing   | Two (2)   | Permit bleed water to dissipate and concrete to set  |
|  |   | Operate a hose drag or squeegee to remove water from the surface   |
|  |   | Check surface for flatness, fill/cut as necessary  |
|  |   | Finish surface with magnesium float  |
|  |   | Apply pulled broom finish at proper time to acceptable texture   |
|  |   | Clean broom when excessive mortar adheres  |
|  |   | Remove excess water from broom before use  |
|  |   | Finish edges and joints  |
|  |   | Finish well formed, properly spaced joints to sufficient depth   |
| Prohibited Practices: Steel troweling or floating; adding water to the surface; excessive working of surface; pushing broom across surface |   |  |

<sup>[1]</sup> Recommended number of operators.

**Table 701.62-2: Minimum Operator Activities (Continued)**

| <b>Operation</b>                      | <b>Operators<sup>[1]</sup></b>  | <b>Activity</b>  |
|---------------------------------------|---|--|
| 701.44:<br>Intermediate<br>Curing     | If applicable, apply an intermediate curing material and procedure per 701.44 |  |
|                                       | One (1)   | 701.30.C.1: Liquid-Applied Evaporation Reducers  |
|                                       | One (1)   | 701.30.E.3.a: Liquid Membrane-Forming Compounds  |
|                                       | One (1)   | 701.30.E.3.b: Liquid Membrane-Forming Compounds for Curing and Sealing   |
| 701.45:<br>Final Curing               | Apply a final curing material and procedure meeting 701.45                    |  |
|                                       | Four (4)  | 701.30.E.1: Saturated Covers   |
|                                       | Four (4)  | 701.30.E.2: Sheet Materials  |
|                                       | One (1)   | 701.30.E.3.a: Liquid Membrane-Forming Compounds  |
|                                       | One (1)   | 701.30.E.3.b: Liquid Membrane-Forming Compounds for Curing and Sealing   |
| 701.46:<br>Protective<br>Sealing      | One (1)   | If applicable, apply a protective sealing material and procedure per 701.46  |
| 701.47:<br>Cold Weather<br>Concreting | Four (4)  | If applicable, apply cold weather concreting materials and procedures per 701.47 and the Department approved Contractor cold weather concreting plan |
| 701.48:<br>Hot Weather<br>Concreting  | Four (4)  | If applicable, apply hot weather concreting materials and procedures per 701.48 and the Department approved Contractor hot weather concreting plan   |

<sup>[1]</sup> Recommended number of operators.

**701.63: Quality Control Inspection**

Quality Control inspection shall be performed and reported on inspection report forms by qualified Quality Control Technicians, to confirm conformance to specifications and to visually inspect equipment, environmental conditions, materials, and workmanship. Quality Control Technicians shall obtain at least one of the following personnel certifications.

- NRMCA Concrete Exterior Finisher Certification
- ACI Concrete Flatwork Technician and Flatwork Finisher

Quality Control inspection report forms shall be completed by the Contractor and submitted to the Department for review.

**DEPARTMENT ACCEPTANCE**

**701.70: General**

Acceptance shall be performed by the Department, including consultants under direct contract with the Department independent of the Contractor, to evaluate the degree of compliance with contract requirements, to monitor each Contractor entity’s Quality Control activities, to determine the

corresponding value for a given product, and to determine the acceptability of all material produced and placed.

**701.71: Acceptance of Contractor Quality Control Plan**

The Department will review the Contractor Quality Control Plan. Department approval shall be subject to conformance with the requirements specified herein.

**701.72: Acceptance Inspection**

Acceptance inspection will be performed and reported by qualified Department (or designee) Acceptance Technicians, to confirm conformance to specifications and to visually inspect equipment, environmental conditions, materials, and workmanship.

**701.73: Acceptance Sampling and Testing**

Acceptance sampling and testing will be performed and reported by qualified Department (or designee) Acceptance Technicians, to provide quality characteristic data used for Department Acceptance determination, per the requirements specified herein.

**Table 701.73-1: Minimum Acceptance Sampling and Testing Requirements**

| Property    | Method                  | Quality Characteristic   | Sublot Size | Minimum Test Frequency                   | Point of Sampling  | Criteria           |
|-------------|-------------------------|--|-------------|--|--------------------|--------------------|
| Uniformity  | T 119                   | Slump Allowable Tolerance (in.) <sup>[1]</sup>                             | 100 cy      | 1 per Sublot                             | Point of Discharge | Target $\pm$ 1.5   |
| Workability | T 119                   | Segregation Resistance <sup>[2]</sup>                                      | 100 cy      | 1 per Sublot                             | Point of Discharge | Pass               |
| Thermal     | T 309                   | Concrete Temperature ( $^{\circ}$ F)                                       | 100 cy      | 1 per Sublot                             | Point of Discharge | 50 – 90            |
| Strength    | T 22                    | Compressive Strength at 7 Days for Curing Termination (psi) <sup>[3]</sup> | 100 cy      | 1 per Sublot                             | Point of Discharge | $\geq$ 70% $f'_c$  |
|             |                         | Compressive Strength at 28 Days (psi) <sup>[3]</sup>                       | 100 cy      | 1 per Sublot                             | Point of Discharge | $\geq$ 100% $f'_c$ |
|             |                         | Compressive Strength at 56 Days (psi) <sup>[3][4]</sup>                    | 100 cy      | 1 per Sublot                             | Point of Discharge | $\geq$ 100% $f'_c$ |
| Durability  | T 121<br>T 152<br>T 196 | Freezing and Thawing Resistance: Air Content (%)                           | 100 cy      | 1 per Sublot                             | Point of Discharge | 5.5 – 8.5          |
|             | T 303 or C1567          | Alkali Silica Reaction Resistance: Expansion at 14 Days (%)                | –           | 1 per Annual Mix Design Submission Cycle | –                  | $\leq$ 0.08        |

<sup>[1]</sup> Test result and the Producer's mix design target shall be within the specified allowable tolerances. Slump shall be reported on the Producer's mix design batch ticket for each delivery.

<sup>[2]</sup> Testing for segregation resistance shall be performed while the concrete is being discharged and during AASHTO T 119 Standard Method of Test for Slump of Hydraulic Cement Concrete. Visual signs of segregation include coarse particles advancing in front of or behind the fine particles and mortar and a tendency for coarse aggregate to separate from the mortar, particularly when the mixture is being consolidated.

<sup>[3]</sup> Three (3) 4 x 8 in. compressive strength cylinders shall be cast and tested for each age per sublot.

<sup>[4]</sup> Testing only required if compressive strength results at 28 days do not conform with specifications.

## COMPENSATION

### 701.80: Method of Measurement

Cement Concrete Sidewalks, Pedestrian Curb Ramps, and Driveways will be measured in square yards.

Excavation will be measured by the cubic yard as specified in 120.80: Method of Measurement.

Gravel Borrow will be measured by the cubic yard as specified in 150.80: Method of Measurement.

Fine grading and compacting will be measured by the square yard as specified in 170.88: Method of Measurement.

**701.81: Basis of Payment**

Cement Concrete Sidewalk, Cement Concrete Pedestrian Curb Ramp, and Cement Concrete Driveway will be paid for at the contract unit price per square yard complete in place, including detectable warning panels and all incidental materials, labor, and equipment necessary to complete the work to the satisfaction of the Engineer.

Gravel will be paid for at the contract unit price per cubic yard under Item 151: Gravel Borrow.

Fine grading and compacting will be paid for at the contract unit price per square yard under Item 170: Fine Grading and Compacting – Subgrade Areas.

Excavation will be paid for at the contract unit price per cubic yard under the excavation items.

**701.82: Payment Items**

|       |  |             |
|-------|--|-------------|
| 701.  | Cement Concrete Sidewalk.....              | Square Yard |
| 701.1 | Cement Concrete Sidewalk Driveways .....   | Square Yard |
| 701.2 | Cement Concrete Pedestrian Curb Ramp ..... | Square Yard |



## GUIDE TO THE INTERIM SUBSECTION 701 CEMENT CONCRETE SIDEWALK SPECIFICATION

### MATERIALS ACTIVITIES

| Section         | Activity   |                |
|-----------------|--|----------------|
| <b>701.30.A</b> | <b>Combined Aggregate System</b>   |                |
| 701.30.A.1      | The mix design's combined aggregate system should meet Table 701.30-1: Tarantula Curve Particle Size Distribution.   | Recommendation |
| 701.30.A.2      | The mix design's combined aggregate system should meet Table 701.30-2 / Figure 701.30-1: Shilstone Workability-Coarseness.   | Recommendation |
| 701.30.A.3      | The mix design's combined aggregate system should be analyzed using the Fineness Modulus.  | Recommendation |
| 701.30.A.4      | The mix design's combined aggregate system should be analyzed using the Coarse Aggregate Content.  | Recommendation |
| <b>701.30.B</b> | <b>Paste System</b>  |                |
| 701.30.B.1      | The mix design's Water-Cementitious Ratio should be $\leq 0.40$ (Table 701.30-3: Freezing, Thawing, and De-icing Resistance).  | Recommendation |
| 701.30.B.1      | The mix design's Water-Cementitious Ratio shall be $\leq 0.45$ (Table 701.30-3: Freezing, Thawing, and De-icing Resistance).   | Required       |
| 701.30.B.2      | The mix design's Air Content should approach the recommended Air Content Targets identified in Table 701.30-4: Freezing, Thawing, and De-icing Resistance.   | Recommendation |
| 701.30.B.3      | The mix design's Cement and Supplementary Cementitious Materials (SCM) Content shall meet Table 701.30-5: Alkali Silica Reaction and Freezing, Thawing, and De-icing Resistance requirements.  | Requirement    |
| 701.30.B.3      | Test results meeting Table 701.30-6: Alternative Performance Evaluation to Alkali Silica Reaction Resistance requirements may be used in lieu of the mix design requirements identified in Table 701.30-5: Alkali Silica Reaction and Freezing, Thawing, and De-icing Resistance requirements. | Optional       |
| 701.30.B.4      | The mix design should incorporate Chemical Admixtures identified in Table 701.30-7: Chemical Admixtures to enhance the properties of the concrete.   | Recommendation |
| 701.30.B.5      | The mix design's Paste Content should approach the recommended targets identified in Table 701.30-8: Paste Content.  | Recommendation |

| <b>701.73 Acceptance Sampling and Testing</b> |   |             |
|---|---|-------------|
| T 119   | The Slump shall meet Table 701.71-1: Minimum Acceptance Sampling and Testing Requirements ( $\pm 1.5$ from Slump Target identified by the Concrete Producer on the Batch Ticket). | Requirement |
| T 119   | The Segregation Resistance shall meet Table 701.71-1: Minimum Acceptance Sampling and Testing Requirements.   | Requirement |
| T 309   | The Concrete Temperature shall meet Table 701.71-1: Minimum Acceptance Sampling and Testing Requirements.   | Requirement |
| T 22  | The Compressive Strength (7, 28, and 56 days) shall meet Table 701.71-1: Minimum Acceptance Sampling and Testing Requirements.  | Requirement |
| T 121<br>T 152<br>T 196                       | The Air Content shall meet Table 701.71-1: Minimum Acceptance Sampling and Testing Requirements (5.5 – 8.5%).   | Requirement |
| T 303 or<br>C1567                             | The resistance to Alkali Silica Reaction shall meet Table 701.71-1: Minimum Acceptance Sampling and Testing Requirements (One per year for mix design verification).              | Requirement |

**CONTRACTOR ACTIVITIES**

| <b>Section</b> | <b>Activity</b>  |                |
|----------------|--|----------------|
| <b>701.40</b>  | <b>Pre-Placement</b>   |                |
|                | The Contractor should have a minimum of two (2) Operators.   | Recommendation |
|                | The Contractor shall apply sufficient base compaction.   | Requirement    |
|                | The Contractor shall moisten sub-base, free of standing water.   | Requirement    |
|                | The Contractor shall secure forms, straight and level.   | Requirement    |
|                | The Contractor shall mark expansion locations.   | Requirement    |
|                | The Contractor shall be prohibited from performing the following practices: Placement on frozen sub-grade. | Requirement    |
| <b>701.41</b>  | <b>Placement (Concrete Discharging)</b>  |                |
|                | The Contractor should have a minimum of two (2) Operators.   | Recommendation |
|                | The Contractor shall direct concrete trucks.   | Requirement    |
|                | The Contractor shall handle chute discharge and truck movement.  | Requirement    |
|                | The Contractor shall assist in preparing concrete for testing.   | Requirement    |
|                | The Contractor shall direct trucks to washout area.  | Requirement    |
|                | The Contractor shall provide general help.   | Requirement    |

|               |  |                          |
|---------------|--|--------------------------|
|               | The Contractor / Concrete Producer shall be prohibited from performing the following practices: Adding constituent materials not in conformance with AASHTO M 157 or without Department consent. | Requirement              |
| <b>701.41</b> | <b>Placement</b>   |                          |
|               | The Contractor should have a minimum of two (2) Operators.   | Recommendation           |
|               | The Contractor shall localize placement to minimize moving material.   | Requirement              |
|               | The Contractor shall level concrete in front of the screed.  | Requirement              |
|               | The Contractor shall operate come-alongs or flat headed shovel to move concrete in form.   | Requirement              |
|               | The Contractor shall consolidate concrete along form edge to avoid honeycombing.   | Requirement              |
|               | The Contractor shall operate screed over top of forms in sawing action for surface leveling.   | Requirement              |
|               | The Contractor shall operate magnesium bull float to push coarse aggregate below the surface and fill in the low spots or depressions.   | Requirement              |
|               | The Contractor shall be prohibited from performing the following practices: Toothed raking, dragging of internal vibrator, and internal vibrator to move concrete; steel troweling or floating.  | Requirement              |
| <b>701.42</b> | <b>Initial Curing (When Applicable)</b>  |                          |
|               | The Contractor should have a minimum of one (1) Operator.  | Recommendation           |
|               | The Contractor shall apply 701.30.C.1: Liquid-Applied Evaporation Reducers when applicable.  | Required when applicable |
| <b>701.43</b> | <b>Finishing</b>   |                          |
|               | The Contractor should have a minimum of two (2) Operators.   | Recommendation           |
|               | The Contractor shall permit bleed water to dissipate and concrete to set.  | Requirement              |
|               | The Contractor shall operate a hose drag or squeegee to remove water from the surface.   | Requirement              |
|               | The Contractor shall check surface for flatness, fill/cut as necessary.  | Requirement              |
|               | The Contractor shall finish surface with magnesium float.  | Requirement              |
|               | The Contractor shall apply pulled broom finish at proper time to acceptable texture.   | Requirement              |
|               | The Contractor shall clean broom when excessive mortar adheres.  | Requirement              |
|               | The Contractor shall remove excess water from broom before use.  | Requirement              |

|               |   |  |
|---------------|---|--|
|               | The Contractor shall finish edges and joints.   | Requirement  |
|               | The Contractor shall finish well formed, properly spaced joints to sufficient depth.  | Requirement  |
|               | The Contractor shall be prohibited from performing the following practices: Steel troweling or floating; adding water to the surface; excessive working of surface; pushing broom across surface.   | Requirement  |
| <b>701.44</b> | <b>Intermediate Curing (When Applicable, Apply One of the Methods)</b>  |  |
|               | The Contractor should have a minimum of one (1) Operator.   | Recommendation   |
|               | The Contractor shall apply 701.30.C.1: Liquid-Applied Evaporation Reducers when applicable and if selected.   | Required when applicable   |
|               | The Contractor shall apply 701.30.E.3.a: Liquid Membrane-Forming Compounds when applicable and if selected.   | Required when applicable   |
|               | The Contractor shall apply 701.30.E.3.b: Liquid Membrane-Forming Compounds for Curing and Sealing when applicable and if selected.  | Required when applicable   |
| <b>701.45</b> | <b>Final Curing (Apply One of the Methods)</b>  |  |
|               | The Contractor should meet the minimum number of operators identified in Table 701.62-2: Minimum Operator Activities.   | Recommendation   |
|               | The Contractor shall apply 701.30.E.1: Saturated Covers if selected.  | Requirement  |
|               | The Contractor shall apply 701.30.E.2: Sheet Materials if selected.   | Requirement  |
|               | The Contractor shall apply 701.30.E.3.a: Liquid Membrane-Forming Compounds if selected.   | Requirement  |
|               | The Contractor shall apply 701.30.E.3.b: Liquid Membrane-Forming Compounds for Curing and Sealing if selected.  | Requirement  |
| <b>701.46</b> | <b>Protective Sealing (If Required)</b>   |  |
|               | The Contractor should have a minimum of one (1) Operator.   | Recommendation   |
|               | The Contractor shall apply 701.30.F: Protective Sealing Compounds at least 28 days after placement. Application of 701.30.F: Protective Sealing Compounds is <b>NOT REQUIRED IF 701.30.E.3.b: Liquid Membrane-Forming Compounds for Curing and Sealing was applied.</b> | Required if 701.30.E.3.b Curing and Sealing Compound was Not Applied |
| <b>701.47</b> | <b>Cold Weather Concreting (When Applicable)</b>  |  |
|               | The Contractor should have a minimum of four (4) Operators.   | Recommendation   |
|               | The Contractor shall submit a Cold Weather Concreting Plan meeting 701.47.  | Required when applicable   |

|               |   |                          |
|---------------|---|--------------------------|
|               | The Contractor shall apply cold weather concreting materials and procedures meeting 701.47 and the Department approved Contractor cold weather concreting plan.   | Required when applicable |
| <b>701.48</b> | <b>Hot Weather Concreting (When Applicable)</b>   |                          |
|               | The Contractor should have a minimum of four (4) Operators.   | Recommendation           |
|               | The Contractor shall submit a Hot Weather Concreting Plan meeting 701.48.   | Required when applicable |
|               | The Contractor shall apply hot weather concreting materials and procedures meeting 701.47 and the Department approved Contractor hot weather concreting plan.   | Required when applicable |
| <b>701.61</b> | <b>Contractor Quality Control Plan</b>  |                          |
|               | The Contractor shall prepare and submit a Quality Control Plan (QC Plan) to the Department for review.  | Requirement              |
| <b>701.62</b> | <b>Production Personnel</b>   |                          |
| 701.62.A      | Foreman   |                          |
|               | The Contractor shall have a minimum of One (1) Foreman.   | Requirement              |
|               | A Foreman shall be present throughout the entire duration of the construction operation with at least one of the following personnel certifications. <ul style="list-style-type: none"> <li>• NRMCA Concrete Exterior Finisher Certification</li> <li>• ACI Concrete Flatwork Technician and Flatwork Finisher</li> </ul> | Requirement              |
|               | The Contractor's Foreman shall review and compare batch ticket quantities and sources to approved mix design.   | Requirement              |
|               | The Contractor's Foreman shall monitor conformance to AASHTO M 157 Standard Specification for Ready-Mixed Concrete.   | Requirement              |
|               | The Contractor's Foreman shall monitor conformance to Department specifications.  | Requirement              |
|               | The Contractor's Foreman shall monitor Production Personnel activities.   | Requirement              |
|               | The Contractor's Foreman shall verify that proper equipment is on hand prior to start of construction.  | Requirement              |
|               | The Contractor's Foreman shall monitors equipment, environmental conditions, materials, and workmanship.  | Requirement              |
|               | The Contractor's Foreman shall prohibit the use of prohibited equipment and practices.  | Requirement              |
|               | The Contractor's Foreman shall acknowledge sampling, testing, and inspection results.   | Requirement              |

|               |   |             |
|---------------|---|-------------|
| 701.62.B      | <b>Operators</b>  |             |
|               | Concrete sidewalk shall be constructed by sufficiently staffed, trained, experienced, and qualified equipment operators and craftsmen, who are presently involved in sidewalk construction, throughout the entire duration of the construction operation, per the requirements specified in Sections 701.40 to 701.48.  | Requirement |
| <b>701.63</b> | <b>Quality Control Inspection</b>   |             |
|               | <p>Quality Control inspection shall be performed and reported on inspection report forms by qualified Quality Control Technicians, to confirm conformance to specifications and to visually inspect equipment, environmental conditions, materials, and workmanship. Quality Control Technicians shall obtain at least one of the following personnel certifications.</p> <ul style="list-style-type: none"> <li>• NRMCA Concrete Exterior Finisher Certification</li> <li>• ACI Concrete Flatwork Technician and Flatwork Finisher</li> </ul> <p>Quality Control inspection report forms shall be completed by the Contractor and submitted to the Department for review</p> | Requirement |

DOCUMENT 00715



## SUPPLEMENTAL SPECIFICATIONS

(English Units)

SEPTEMBER 30, 2023

The 2023 *Standard Specifications for Highways and Bridges* are amended by the following modifications, additions and deletions. This Supplemental Specifications prevail over those published in the Standard Specifications.

The Specifications Committee has issued these Supplemental Specifications for inclusion into each proposal until such time as they are updated or incorporated into the next Standard Specifications.

Contractors are cautioned that these Supplemental Specifications are dated and will change as they are updated.

### DIVISION I

#### GENERAL REQUIREMENTS AND COVENANTS

##### SECTION 1: DEFINITION OF TERMS

Subsection 1.02: References, Abbreviations, Acronyms, Measurement Units and Symbols  
*Under B. Abbreviations and Acronyms delete the line containing NTPEP.*

##### SECTION 2.00: PROPOSAL REQUIREMENTS AND CONDITIONS

Subsection 2.04: Preparation of Proposals  
*Replace the fourth paragraphs with the following:*

At the designated time of the bid opening the Department will accept as the official bid, the set of proposal forms generated from the electronic proposal which includes the bid item sheets, bid bond, addendum acknowledgement, and affidavit of non-collusion.

##### SECTION 4: SCOPE OF WORK

Subsection 4.03: Extra Work  
*Replace the third and fourth paragraphs with the following:*

Payment for extra work will be as provided in Subsection 9.03: Payment for Extra Work.

The determination of the Engineer shall be final upon all questions concerning the amount and value of Extra Work (except as provided in Subsection 7.16: Claims of Contractor for Compensation.

If the Contractor disputes the scope, cost or time associated with the executed Extra Work Order or the determination by the Engineer for requested extra work, then the Contractor must deliver to the Department written notice of a claim in accordance with Subsection 7.16: Claims of Contractor for Compensation.

**Subsection 4.04: Changed Conditions**

*Add new paragraph (b) and re-letter existing paragraphs (b) through (e) to (c) through (f):*

- (b) In the event the Engineer's report finds no material or substantial change in conditions, the Contractor may file a Notice of Claim in accordance with Subsection 7.16: Claims of Contractor for Compensation.

**SECTION 5: CONTROL OF WORK****Subsection 5.02: Plans and Detail Drawings**

*Replace the 7<sup>th</sup> paragraph from the top with the following:*

The title block of shop drawings shall include, at a minimum, the following information: fabricator's name and address; city(ies) or town(s) where the project is located; location(s) where the material is to be used; MassDOT contract number; Federal aid project number, when applicable; MassDOT Project Number; name of the contractor, the subcontractor; date of drawing and date of all revisions. The title block for shop drawings of bridge projects shall also include: the bridge number and BIN; facility on the bridge; the feature under the bridge.

**Subsection 5.09: Inspection of Work**

*Replace the first paragraph of this subsection the following:*

All materials and each part or detail of the work shall be subject to inspection by the Engineer. The Engineer shall be allowed access to all parts of the work and shall be furnished with such information and assistance by the Contractor as is required to make a complete and detailed inspection; such assistance may include furnishing labor, boats, tools, equipment, and personal protective equipment at no expense to the Department.

**SECTION 6: CONTROL OF MATERIALS****Subsection 6.01: Source of Supply and Quality**

*Replace this subsection with the following:*

The Engineer may approve material at the source of supply before delivery to the project.

The Department reserves the right to require approval of the source of supply for any material to be incorporated into the work prior to delivery or manufacture.

The Engineer reserves the right to prohibit the use of materials, products, or components which, in their opinion, may be supplied in a manner not reasonably consistent with contract requirements.

The determination of the Engineer shall be final upon all questions which pertain to supplier approval.

Fabricators of structural steel, miscellaneous steel and aluminum products, and producers of precast concrete and prestressed concrete must be on the Department's approved fabricators list on the date the bids are opened. Only approved fabricators will be allowed to perform work for the Department.

The Contractor shall furnish all materials required for the work specified in the Contract. Said materials shall meet the requirements of the specifications for the kind of work involving their use. For any materials named or described in these specifications, an approved equivalent to that named or described in the said specifications, may be furnished.

Chapter 7, Section 22, Clause 17, of the General Laws, as amended, shall apply to the purchase by the Contractor of supplies and materials to be used in the execution of this Contract.

The rules referred to require a preference in the purchase of supplies and materials, other considerations being equal, in favor first, of supplies and materials manufactured and sold within the Commonwealth, and second, of supplies and materials manufactured and sold within the United States.

All iron and steel products, manufactured products, and construction materials shall comply with all Federal Buy America and Federal Build America Buy America (BABA) requirements, where applicable.



In Contracts requiring structural steel, precast, or prestress concrete, the Contractor shall furnish approved shop drawings, and fabrication procedures to the Department's inspector at the supply source or fabrication site.

Materials for permanent construction shall be new, shall conform to the requirements of these specifications, and shall be approved by the Engineer.

Materials for temporary structures or supports adjacent to traveled ways, the failure of which would compromise the safety of the public or the traveled ways, need not be new but the Contractor shall be required to submit certification by a Structural Professional Engineer that the material meets the requirements for the intended use and shall be approved by the Engineer. Any fabrication shall conform to the requirements of these specifications. These requirements shall not apply to gantry systems and supports as well as other mechanized systems.

If testing finds that an approved supplier does not furnish a uniform product, or if the product from such source proves unacceptable at any time, the Contractor shall, at their own expense, take any and all steps necessary to furnish approved materials.

The Contractor shall submit to the Department for approval a notarized Certificate of Compliance (COC) from the Manufacturer or Supplier for each kind of manufactured or fabricated material furnished.

The COC shall certify compliance with the specifications and shall contain the following information:

1. Contract Number, City or Town, Name of Road and Federal Aid Number;
2. Name of the Contractor to which the material is supplied;
3. Kind of material supplied;
4. Quantity of material represented by the certificate;
5. Means of definitively identifying the consignment, such as invoice number, lot number, bill of lading number, label, marking, etc.;
6. Date and method of shipment;
7. Statement indicating that the material has been tested and found in conformity with the pertinent parts of the Contract;
8. Statement indicating that the material meets the requirements of Buy America and BABA, where applicable;
9. Results of all required tests including the chemical analysis in the case of metal: or in lieu of furnishing the results a statement that results of all required tests pertinent to the certificate and not submitted shall be maintained available by the undersigned for a period of not less than three years from date of final acceptance or not less than three years from date of final payment (whichever period is the longest shall apply).
10. Signature of a person having legal authority to bind the supplier.

These COCs shall be delivered to the contract site at the same time that the materials are delivered and before such materials are incorporated into the work. The Contractor shall attach to the COC a document listing the contract bid item number(s), sub item(s), or lump sum breakdown item number(s), as applicable, under which the material will be compensated. Payment for the item in which the materials are incorporated may be withheld until these COCs are received in a form that meets the contract requirements.

If the Contractor has new materials purchased for use on a previous Department Contract which have never been used and which comply with the specifications, these materials may be furnished and used. The Contractor shall submit their own sworn statement certifying that such materials were purchased for use on a previous Contract (naming and identifying such Contract) and shall attach the original COC.

Any cost involved in furnishing the certificate shall be borne by the Contractor.

Subsection 6.03: Delivery and Storage of Materials

*Replace this subsection with the following:*

Materials and equipment shall be progressively delivered to or removed from the site so that there will be neither delay in the progress of the work nor an accumulation of materials that are not to be used or removed within a reasonable time. All materials shall be stored in pre-approved locations per the conditions of the property owner.

Delivered materials and materials originating from the site shall be stored to assure the preservation of their quality and fitness for the work. Stored materials, even though approved before storage, may again be inspected prior to their use in the work. Stored materials shall be located to facilitate their prompt inspection.

Approved portions of the State Highway Layout (SHLO) may be used for storage of project materials and for the placing of the Contractor's plant and equipment upon obtaining a state highway access permit. All storage sites shall be restored to their original condition by the Contractor. No additional compensation shall be given for the design, construction, preparation, or restoration of the storage site(s) or obtaining the access permit which may include but is not limited to a Traffic Management Plan (TMP), utilities, and lighting.

The application for a permit shall contain a locus map identifying the proposed location, a description of the specific activities and uses of the staging area, a TMP in accordance with Subsection 7.10 depicting minimum setbacks from the roadway and any existing structures for stored materials and equipment and how equipment will safely access and exit the staging area.

Any additional space required must be provided by the Contractor at their expense. Municipal, private, or other state-owned property shall not be used for storage purposes without written permission of the owner or lessee, and copies of such written permission shall be furnished to the Engineer.

## **SECTION 7: LEGAL RELATIONS AND RESPONSIBILITY TO (THE) PUBLIC**

Subsection 7.09: Public Safety and Convenience

*Delete the word Prime.*

Subsection 7.10: Barricades and Warning Signs

*Replace the entire subsection with the following:*

**Subsection 7.10: Traffic Management Plan**

The Contractor shall submit a Traffic Management Plan to the Department This Plan shall include:

- Contact information for the person(s) responsible for the implementation, oversight, and quality control of the Traffic Management Plan.
- Temporary Traffic Control Plans for all phases of construction.
- Detour Plans (if applicable).
- Public Involvement and Communication Plan (if required by Special Provision).

No work impacting traffic shall commence until the Traffic Management Plan has been approved by the Department.

**Temporary Traffic Control Plans (TTCP)**

The TTCP shall consist of plans depicting the location of all temporary traffic control devices, including but not limited to: channelization devices, barricades, signs, pavement markings, lighting, traffic signals, flashing lights, temporary barrier, temporary attenuators, truck or trailer mounted attenuators, flashing arrow boards, portable changeable message signs, work zone ITS equipment, temporary portable rumble strips, Roadway Flaggers, and Traffic Officers. Specialized short-term conditions such as rolling roadblocks or road/ramp closures lasting for less than 24 hours will also require individual TTCPs.

The TTCP shall also include, as needed, a description or plan of Contractor access and egress to and from the work zones, staging areas and material stockpile and equipment laydown areas. See Subsection 6.03 for material stockpile requirements.

For each phase of construction, the Contractor may choose to use:

- the TTCPs included in the Contract Documents (if provided),
- MassDOT Construction Standards,
- a separate TTCP design from the Contractor,
- or a combination thereof.

The Contractor shall identify the TTCPs they will use in their project TMP Submission, including the use of the Contract specified TTCPs or Construction Standards. All Contractor proposed TTCPs must be approved by MassDOT prior to implementation.

Any TTCP design that varies from the Contract Documents or the Construction Standards shall be stamped and signed by a Professional Engineer registered in Massachusetts.

#### **Detour Plans**

Detour Plans shall be required if access for motor vehicles, heavy vehicles, bicyclists, or pedestrians is temporarily restricted and an alternate route is necessary. Detour plans shall show locations of barricades, signs, portable changeable message signs, and other temporary traffic control devices that are needed to provide directional information to the affected road user(s).

All pedestrian detours shall be on ADA and AAB compliant routes. Any pedestrian detour plans shall be stamped and signed by a Professional Engineer registered in Massachusetts.

#### **Public Involvement and Communication Plans**

Public Involvement and Communication Plans shall be required as noted in the contract Special Provisions. These plans shall include outreach measures and notification to the public to increase awareness of pending traffic impacts.

#### **Additional Contractor Duties**

The Contractor shall maintain all temporary traffic control devices erected or installed as a part of the approved Traffic Management Plan. The Contractor shall furnish staff that will oversee all components of the approved Traffic Management Plan.

All costs associated with the development, submission and implementation of the Traffic Management Plan shall be incidental to the Contract.

#### **Subsection 7.16: Claims of the Contractor for Compensation**

*Replace this subsection with the following:*

No person or corporation, other than the signer of the Contract as Contractor, now has any interest hereunder, and no claim shall be made or be valid; and neither the Department nor any member, agent or employee thereof, shall be liable for, or be held to pay, any money except as provided in Subsections 4.02: Alterations, 4.03: Extra Work, 4.04: Changed Conditions, 4.06: Increased or Decreased Contract Quantities and 9.02: Scope of Payments of these Specifications and Clause 3 of the Contract.

All disputes between the Contractor and the Department shall be resolved as provided by this subsection.

At all times during the claims review process or any subsequent administrative or court proceeding, the Contractor shall proceed with the Work diligently, without delay, in accordance with the Contract, and as directed by the Department. In addition, all parties shall continue to comply with all provisions of the Contract documents.

#### **A. Contractor Claims Submission to the Department (Step 1)**

##### **Notice of Claim**

All claims of the Contractor for compensation other than as provided for in the Contract on account of any act of omission or commission by the Department or its agents must be made in writing to the Engineer within seven (7) days after the beginning of any work or the sustaining of any damage on account of such act.

The Contractor's written notice to the Engineer shall contain the following:

- 1) a description of the nature of the work performed or damage sustained
- 2) the time and date the event was first identified
- 3) the location of the impacted work
- 4) the Contractual basis for the Contractor's claim

#### **Itemized Statement of Claim**

The Contractor shall within thirty (30) days after the beginning of any work or the sustaining of any damage on account of such act shall submit to the Engineer an itemized statement containing the following:

- 1) a detailed description of the Work claimed and sequence of events and location
- 2) a breakdown of actual costs and damages sustained including all supporting documentation
- 3) a Time Entitlement Analysis, if the Contractor is claiming for an extension of Contract time

If the work to be claimed is not completed within the initial thirty (30) days, the Contractor shall submit on a monthly basis the actual costs to-date and an estimated cost to complete. Upon completion of the work a final actual cost shall be submitted in thirty (30) days.

All costs shall be prepared and submitted in accordance with Subsection 9.03: Payment for Extra Work. Any costs associated with the preparation, negotiation, litigation and/or settlement of the claim are not allowable.

Unless such notice and statement shall be made as required, any claim for compensation or additional time shall be forfeited and invalidated, and the Contractor shall not be entitled to payments on account of any such work or damage.

Such notice by the Contractor and the keeping of costs by the Engineer shall not in any way be construed as providing the validity of the claim. The provisions of this paragraph shall not apply to changes in quantities as provided under Subsection 4.06: Increased or Decreased Contract Quantities or to Extra Work ordered by the Engineer in writing.

On the basis of information provided in writing by their own employees, servants, or agents the Contractor will be required to certify, in writing, that the work for which the Contractor is claiming payment, other than as provided for in the Contract, is work actually performed, and the costs as shown are the amounts legally due for performing such work for which payment is claimed.

Upon receipt of a Notice of Claim and itemized statement of costs, the Department and Contractor shall attempt to resolve the issue(s) presented through a review of the materials submitted, and an evaluation of the contract documents. After a complete review, the Department will issue a written decision on the Contractor's claim.

#### **B. Construction Claims Committee Determination (Step 2)**

Within fourteen (14) Days after the receipt date of the Department's written decision denying a claim, the Contractor may file a request with the Chief Engineer for a hearing before the Department's Claims Committee. The Contractor shall also provide any additional information, at the Department's request, that the Department's Claims Committee determines is necessary for its evaluation of the claim. The Contractor's claim information must be enhanced to include sufficient description and information to enable understanding by a third party who has no knowledge of the dispute or familiarity with the Project and this documentation must also include a description of the efforts undertaken to resolve the dispute.

The Contractor shall present the claim to the Claims Committee at a meeting to be scheduled after the filing of the request. After the meeting, the Chief Engineer will provide to the Contractor a written determination on each claim.

### C. Appeal to the Administrative Law Judge (Step 3)

The determination of the Engineer may be appealed to the Department's Administrative Law Judge as established in MGL Ch.6c, s.40, as amended.

The appeal shall set forth the contract number, city or town project is in, the name and address of the Contractor, the amount of the claim (and breakdown of how the amount was computed), a clear, concise statement of the specific determination being appealed, including the reasons for appealing the determination and shall be signed by the Contractor. The Office of the Administrative Law Judge shall record the date and time any such appeal is received, shall keep the appeal on record, and schedule the appeal for a hearing before the Administrative Law Judge.

At any time after the determination by the Claims Committee, the Contractor at its sole discretion may appeal the Claims Committee's determination to the Superior Court Department of the Commonwealth of Massachusetts in the County of Suffolk for further consideration. The Contractor agrees that either on appeal of a decision from the Department's Administrative Law Judge or on direct appeal, the exclusive jurisdiction and venue for any legal action or proceeding, at Law or in equity, arising out of or relating to the Contract Documents or the Project, shall be the Superior Court Department of the Commonwealth of Massachusetts in the County of Suffolk. The Contractor waives all objections it might have to the jurisdiction or venue of such court and hereby consents to such jurisdiction, regardless of the Contractor's residence or domicile, for any such action or proceeding. This subsection does not relieve the Contractor's obligation to submit the Dispute to Superior Court within the applicable statutes of limitations or repose and the Department does not hereby waive its rights to assert defenses based upon such statutes.

Interest on judgments for Contractor claims filed with the Superior Court of Massachusetts shall be calculated pursuant to the provisions of MGL c. 231, s.61 from the date of the breach or demand. If the date of the breach or demand is not established, such interest shall be calculated from the date of the commencement of the action.

Throughout the course of any work that is the subject of any claim the Contractor shall keep complete records of the extra costs and time incurred related to the claim. These records shall be retained for a period of not less than seven (7) years from the date of resolution of the claim.

The acceptance by the Contractor of the final payment made under the provisions of Subsection 9.05: Final Acceptance and Final Payment shall operate as and shall be a release to the Department and every member, agent and employee thereof, from all claim and liability to the Contractor for anything done or furnished for, or relating to, the work, or for any act or neglect of the Department or of any person relating to or affecting the work, except the claim against the Department for the remainder, if any there be, of the amounts kept or retained as provided in Subsection 7.15: Claims Against Contractors for Payment of Labor, Materials and Other Purposes. For claims for extensions of time see Subsection 8.10: Determination and Extension of Contract Time for Completion (Time Extensions).

## SECTION 8: PROSECUTION AND PROGRESS

### Subsection 8.05: Claim for Delay or Suspension of the Work

*Replace the second paragraph with the following:*

Provided, however, that if the Engineer determines that the performance of all or any major portion of the work is suspended, delayed, or interrupted for an unreasonable period of time by an act of the Department in the administration of the Contract, or by the Department's failure to act as required by the Contract within the time specified in the Contract ( or if no time is specified, within a reasonable time) and without the fault or negligence of the Contractor, an adjustment shall be made by the Department for any increase in the actual cost of performance of the Contract (excluding profit and overhead) necessarily caused by the period of such suspension, delay or interruption. No adjustment shall be made if the performance by the Contractor would have been prevented by other causes even if the work had not been so suspended, delayed, or interrupted by the department. The Contractor has an obligation to mitigate costs associated with any delay or suspension.

*Replace the fifth paragraph with the following:*

Any dispute concerning whether the delay or suspension is unreasonable or any other question of fact arising under this paragraph shall be determined by the Engineer, and such determination and decision, in case any question shall arise, shall be a condition precedent to the right of the Contractor to receive any money hereunder. The determination by the Engineer shall be in accordance with Subsection 7.16 Claims of Contractor for Compensation.

Subsection 8.10: Determination and Extension of Contract Time for Completion (Time Extensions)

*Under D. Disputes, replace the second paragraph with the following:*

The Contractor may dispute a determination by the Engineer by filing a claim notice within seven (7) calendar days after the Contractor's request for additional time has been denied or if the Contractor does not accept the number of days granted in a time extension. A determination on the Contractor's claim shall be in accordance with Subsection 7.16 Claims of Contractor for Compensation. The Contractor's claim notice shall include a revised time entitlement analysis that sufficiently explains the basis of the time-related claim. Failure to submit the required time entitlement analysis with the claim notice shall result in denial of the Contractor's claim.

**DIVISION II**

**CONSTRUCTION DETAILS**

**SUBSECTION 430: CEMENT CONCRETE BASE COURSE**

Subsection 430.40: General

*Revise this subsection to read as follows:*

Materials shall meet the requirements specified in the following Subsections of Division III, Materials:

|                                |         |
|--------------------------------|---------|
| Cement Concrete.....           | M4      |
| Preformed Joint Filler.....    | M9.14.0 |
| Hot Applied Crack Sealer ..... | M3.05.2 |

**SUBSECTION 450: HOT MIX ASPHALT PAVEMENT**

Subsection 450.61: Contractor Quality Control Plan

*Replace the fourth sentence in the first paragraph with the following:*

The QC Plan shall sufficiently document the QC processes of all Contractor parties (i.e. Contractor, Subcontractors, Producers) performing work required under this specification.

**SUBSECTION 460: HOT MIX ASPHALT PAVEMENT FOR LOCAL STREETS**

Subsection 460.61: Contractor Quality Control Plan

*Replace the fourth sentence in the first paragraph with the following:*

The QC Plan shall sufficiently document the QC processes of all Contractor parties (i.e., Contractor, Subcontractors, Producers) performing work required under this specification.

**SUBSECTION 466: STRESS ABSORBING MEMBRANE & STRESS  
ABSORBING MEMBRANE INTERLAYER**

Subsection 466.61: Contractor Quality Control Plan

*Replace the second sentence in the first paragraph with the following:*

The QC Plan shall sufficiently document the QC processes of all Contractor parties (i.e. Contractor, Subcontractors, Producers) performing work required under this specification.

## SUBSECTION 476: CEMENT CONCRETE PAVEMENT

### Subsection 476.64: Placing Concrete

Delete the third paragraph from the bottom of this subsection.

### Subsection 476.81: Basis of Payment

Delete the last paragraph of this subsection.

## SUBSECTION 480: PAVEMENT CRACK SEALING

### Subsection 480.61: Contractor Quality Control Plan

Replace the first paragraph with the following:

The Contractor shall provide and maintain a QC Plan which shall sufficiently document the QC processes of all Contractor parties (i.e., Contractor, Subcontractors, Producers) performing work required under this specification.

## SUBSECTION 629: CONCRETE BARRIER

### SECTION 629: Concrete Barrier

Replace this subsection with the following:

#### DESCRIPTION

##### **629.20: General**

This item shall consist of furnishing and placing Portland cement concrete barrier on an accepted prepared subgrade or sub-base in accordance with these specifications and in reasonably close conformity with the lines, grades and dimensions shown on the plans.

#### MATERIALS

##### **629.40: General**

Materials shall meet the requirements specified in the following Subsections of Division III, Materials:

|  |          |
|--|----------|
| Cement and Cement Concrete Materials.....  | M4       |
| Precast Concrete Highway Units .....       | M4.02.14 |
| Cement Concrete Blocks .....               | M4.05.1  |
| High Performance Concrete .....            | M4.06.1  |
| Steel Reinforcement .....                  | M8.01.0  |
| Epoxy Coated Reinforcing Bars .....        | M8.01.7  |
| Preformed Joint Filler .....               | M9.14.0  |
| Demountable Reflectorized Delineators..... | M9.30.7  |

Plain dowel bars shall conform to ASTM A36 and shall be galvanized according to AASHTO M 111M/M 111.

#### CONSTRUCTION METHODS

##### **629.60: General**

Concrete barrier shall be either precast or cast-in-place and conform to M4: Cement and Cement Concrete Materials.

The subgrade shall be properly shaped and compacted as specified in Subsection 170: Grading.

##### **629.61: Precast Barrier**

Precast barrier shall meet M4.02.14 Precast Concrete Highway Units.

**629.62: Cast-in-Place Barrier****A. Conventionally Formed Barrier.**

Forms shall be accurately set to the required line and grade, secured by a method not detrimental to the roadway pavement and maintained in a true position during concrete placement.

Form removal shall meet M4.02.14: Precast Concrete Highway Units.

**B. Slipformed Barrier.**

Concrete traffic barriers may be constructed by the use of slipform equipment provided that the finished barrier is true to the specified line and grade within a tolerance of  $\pm\frac{1}{4}$  in. in 10 ft.

The barrier shall present a smooth, uniform appearance in its final position, and shall conform to the horizontal and vertical lines shown on the plans or as directed by the Engineer. Any unsatisfactory section of the barrier shall be removed and replaced at the Contractor's expense.

The concrete shall be vibrated and worked until adequately consolidated and free of honeycomb. The concrete shall be of such consistency after slipforming that it will maintain the shape of the barrier without support. Prior to the beginning of operations, the Contractor shall ensure that a continuous supply of concrete is available to the slipform machine to minimize starting and stopping. The slump of concrete shall not exceed 1.5 in.

The slipform machine shall be guided by vertical and horizontal sensors that ride along a wire line. A grade line gauge or pointer shall be attached to the machine in such a manner that a continual comparison can be made between the barrier being placed and the established grade line. The slipform machine shall not exceed the speed recommended by the manufacturer. In lieu of sensor controls, the slipform machine may be operated on rails or supports set at the required grade.

**629.63: Concrete Median Barrier Cap**

The work consists of constructing a 4-in.-thick cast-in-place cap between the single face median barriers as shown on the plans.

The cap shall be cast in place on a gravel foundation with the length of each section being 30 ft. A  $\frac{1}{2}$ -in. premolded joint filler will be placed between these 30-ft sections. A  $\frac{1}{2}$ -in. premolded joint filler will be placed around bridge pier columns and along the joints between the barrier and the cap where required.

**629.64: Placement of Barriers**

Precast concrete barrier units shall be placed on a previously compacted gravel foundation utilizing 24-in. by 24-in. by 8-in. concrete leveling blocks conforming to the provisions of M4.05.1 set flush with the top of the gravel to control setting of the unit to the proper grade.

The Contractor shall schedule their operation and sequence of installation of the barriers so that a minimum amount of closure pieces will be required.

Expansion and construction joints shall be as shown on the Construction Standards.

Any units showing cracks or other damages due to curing, transportation, installation or other acts of the Contractor shall be removed and replaced by the Contractor at no additional compensation.

**629.65: Finishing, Curing, and Protective Sealing**

Cast-in-place barrier shall be finished, cured, and sealed according to the applicable specifications of M4.02.14: Precast Concrete Highway Units.



**629.66: Delineators**

Delineators shall be installed in conformance with manufacturer's recommendations at beginnings and ends of each continuous run of barrier with intermediate placement at intervals shown on the Plans.

Delineators shall be mounted at appropriate angles to provide maximum retroreflectivity.

**COMPENSATION**

**629.80: Method of Measurement**

Concrete barrier will be measured by the foot along the center line of top of barrier.

Cast-in-place median barrier cap concrete will be measured by the cubic yard in place.

**629.81: Basis of Payment**

Concrete Barrier will be paid for at the contract unit price per foot which includes full compensation for all labor, equipment; materials including finishing, curing, protective sealing, delineators, reinforcing steel, premolded filler, concrete leveling blocks and all incidental work necessary to complete the work as specified.

Cast-in-place Concrete Median Barrier Cap will be paid for at the contract unit bid price per cubic yard. This unit price shall include full compensation for all labor, tools, equipment, materials, including reinforcing steel, finishing, curing, protective sealing, premolded joint filler, and all incidental work necessary to complete the work as specified.

Gravel borrow for the foundation of the barriers and between the sections will be paid for under Item 151; Gravel Borrow.

**629.82: Payment Items**

|        |   |            |
|--------|---|------------|
| 629.1  | Precast Concrete Barrier - Single Faced .....             | Foot       |
| 629.2  | Precast Concrete Median Barrier - Double Faced.....       | Foot       |
| 629.3  | Cast-in-Place Concrete Barrier - Single Faced.....        | Foot       |
| 629.4  | Cast-in-Place Concrete Median Barrier - Double Faced..... | Foot       |
| 629.5  | Cast-in-Place Median Barrier Cap.....                     | Cubic Yard |
| 629.11 | 32-in. Concrete Barrier, TL-3.....                        | Foot       |
| 629.12 | 36-in. Concrete Barrier, TL-4.....                        | Foot       |
| 629.13 | 42-in. Concrete Barrier with Highway Light, TL-4.....     | Each       |
| 629.14 | 42-in. Concrete Barrier, TL-5.....                        | Foot       |
| 629.15 | 54-in. Concrete Barrier, TL-5.....                        | Foot       |
| 629.21 | 32- to 36-in. Concrete Barrier Transition .....           | Each       |
| 629.22 | 36- to 42-in. Concrete Barrier Transition .....           | Each       |
| 629.23 | 42- to 54-in. Concrete Barrier Transition .....           | Each       |

**SUBSECTION 701: CEMENT CONCRETE SIDEWALKS, PEDESTRIAN CURB RAMPS AND DRIVEWAYS**

Subsection 701.61: Contractor Quality Control Plan

*Replace the second sentence with the following:*

The QC Plan shall sufficiently document the QC processes of all Contractor parties (i.e., Contractor, Subcontractors, Producers) performing work required under this specification.

## **SUBSECTION 702: HOT MIX ASPHALT SIDEWALKS AND DRIVEWAYS**

### Subsection 702.61: Contractor Quality Control Plan

*Replace the second sentence with the following:*

The QC Plan shall sufficiently document the QC processes of all Contractor parties (i.e. Contractor, Subcontractors, Producers) performing work required under this specification.

## **SUBSECTION 717: METAL BIN-TYPE RETAINING WALL**

### Subsection 717: METAL BIN-TYPE RETAINING WALL

*Delete this subsection.*

## **SUBSECTION 820: HIGHWAY LIGHTING**

### Subsection 820.20: General

*Replace the last paragraph of this subsection with the following:*

It is not intended that every fitting, minor detail or feature be shown and described, as the Contractor or the Subcontractor is assumed to be an expert in the particular area of responsibility and is capable of interpreting the Plans, Specifications and Special Provisions so that the bid shall include all items required and that they shall be provided and installed in a neat and workmanlike manner.

## **SUBSECTION 945: DRILLED SHAFTS**

### Subsection 945.61: Drilled Shafts and Load Tests

*Delete the last sentence of paragraph B., 2., c.*

*Delete the last sentence in the fourth paragraph under B., 4.*

## **SUBSECTION 965: MEMBRANE WATERPROOFING FOR NEW BRIDGE DECKS**

### Subsection 965.61: Contractor Quality Control Plan

*Change the word should to shall and delete the word Prime in the first paragraph.*

**DIVISION III**  
**MATERIALS SPECIFICATIONS**  
**SECTION M1: SOILS AND BORROW MATERIALS**

Subsection M1.06.0: Organic Soils Additives

*Replace this subsection with the following:*

**M1.06.0: Compost**

The Contractor shall submit for approval a written list of all vendors of manufactured compost that will be used on the project, including locations of compost facilities and feedstock materials. All vendors shall submit certified results of regular periodic testing per US Compost Council Seal of Testing Assurance (STA) Program.

In addition, the Contractor shall provide representative 1-gallon samples from each proposed source for testing and analysis. The Contractor shall deliver samples to testing laboratories and shall have the testing report sent directly to the Engineer. Compost tests shall be performed by STA-certified laboratory.

(<https://www.compostingcouncil.org/page/CertifiedLabs>)

Compost shall be a well-decomposed humus material derived from the aerobic decomposition of biodegradable matter, free of viable weed seeds and other plant propagules (except airborne weed species), foreign debris such as glass, plastic, etcetera and substances toxic to plants. Compost shall be suitable for use as a soil amendment and shall support the growth of ornamental nursery stock and turf establishment. Compost shall be in a shredded or granular form and free from hard lumps.

Food and agriculture residues are acceptable source materials. Biosolids and peat are not acceptable source materials.

Composted material with an unpleasant odor, such as that of ammonia or fecal material shall be rejected by the Engineer.

Compost shall have the following properties:

**Table M1.06-1: Compost Properties by Type of Compost**

| Parameter   | Units                                     | Type 1<br>Organic<br>Amendment<br>to Loam | Type 2<br>Compost<br>Blanket and<br>Compost for<br>Modified Rock | Type 3<br>Compost Filter<br>Berm   | Type 4<br>Sediment Barrier<br>Media |
|---|---|---|--|--|-------------------------------------|
| pH  | pH units                                  | 6.0-8.5                                   | 6.0-8.5  | 6.0-8.5  | 5.0-8.5                             |
| Soluble Salt<br>Concentration (Electrical<br>Conductivity)              | dS/m                                      | Max 10                                    | Max 5  | Max 5  | Max 10                              |
| Moisture Content  | %, wet weight                             | 30-60                                     | 30-60  | 30-60  | < 60                                |
| Organic Matter Content  | %, dry weight                             | 30-65                                     | 25-65  | 25-65  | 25-100                              |
| Particle Size<br>% passing a selected<br>mesh size, dry weight<br>basis | 3 inch                                    | -   | 100% passing   | 100% passing   | 2 inch, 99% to<br>100% passing      |
| Particle Size<br>% passing a selected<br>mesh size, dry weight<br>basis | 1 inch                                    | -   | 90% to 100%<br>passing   | 90% to 100%<br>passing   | -                                   |
|   | 3/4 inch                                  | -   | 65% to 100%<br>passing   | 70% to 100%<br>passing   | 3/8 inch, max<br>of 50% passing     |
|   | 3/8 inch                                  | 95% passing                               | -  | -  | -                                   |
|   | 1/4 inch                                  | 95% passing                               | 0% to 75%<br>passing   | 30% to 75%<br>passing (no more<br>than 60%<br>passing 1/4 inch<br>in high<br>rainfall/flow rate<br>situations) | -                                   |
|   | Particle length                           | Max. 6 inch                               | Max. 6 inch  | Max. 6 inch  | Max. 2 inch                         |
| Stability   |   |   |  |  |                                     |
| Carbon Dioxide Evolution<br>Rate  | mg CO <sub>2</sub> -C per g<br>OM per day | < 4                                       | < 4  | < 4  | < 8                                 |
| Maturity<br>(plant bioassay)  | %, germination<br>and vigor               | > 80 / 80                                 | > 80 / 80  | N/A  | N/A                                 |
| Physical Contaminants<br>(Man-made inert<br>materials)                  | %, dry weight                             | < 0.5%<br>(0.25% film<br>plastic)         | < 0.5 (0.25 film<br>plastic)                                     | < 0.5 (0.25 film<br>plastic)   | < 0.5 (0.25) film<br>plastic)       |

## SECTION M3: ASPHALTIC MATERIALS

### Subsection M3.01.6: Asphalt Release Agents

Replace this subsection with the following:

Approved asphalt release agents shall be tested in accordance with AASHTO T 383 and be listed on the QCML. The asphalt release agent shall not be detrimental to the HMA and shall not dissolve asphalt binder when applied to the truck bed. Dilution by diesel or other petroleum products will not be permitted.

### Subsection M3.06.4: Hot Mix Asphalt Mixture Design

Replace the first sentence in paragraph G. OGFC Design Requirements with the following:

Each OGFC asphalt mixture shall be designed in accordance with AASHTO R 113, as modified herein.

In Table 3.06.4-7, OGFC Mixture Requirements, Note 2, replace TP 108 with T 401.

### Subsection M3.06.5: Verification of Laboratory Trial Mix Formula

In Table 3.06.5-2 OGFC LTMF Verification Limits, replace TP 108 with T 401.

## SECTION M4 CEMENT AND CEMENT CONCRETE MATERIALS

### Subsection M4.02.00: Cement Concrete

Replace this subsection with the following:

Producers shall report proposed mix design formulations onto the Department issued mix design sheet in its entirety and submit to the Department for review. Mix design formulations shall meet the requirements specified in the construction standard specifications, contract document special provisions, design plans, and herein. Mix design formulations shall be approved by the Department prior to construction.

Mix design formulations shall be designed with precise proportions of constituent materials, yielding 27.0 ft<sup>3</sup> (1 cubic yard) of cement concrete. All required mix design targets shall be reported on the Department issued mix design sheet for each proposed mix design. Mill certifications and technical data sheets of the constituent materials incorporated into the proposed mix design formulation shall accompany the mix design formulation submission.

Cement concrete shall be classified and reported according to the mix design formulation's 28-day compressive strength ( $f'_c$ ), nominal maximum aggregate size (NMAS), total cementitious content (lb), air content (%), water-cementitious (w/cm) ratio, paste content (%), paste content-void content (PC/VC) ratio, slump (in.), unit weight (lb/ft<sup>3</sup>), and mix type. Nominal maximum aggregate size (NMAS) shall be determined from the combined aggregate system of the proposed mix design formulation, and is defined as the sieve size immediately above the first sieve size that cumulatively retains more than 10% by mass.

**Table M4.02.00-1: Classifications of Concrete Mixes**

| Class 28-Day<br>Compressive Strength | Minimum Total Cementitious Content<br>(Pounds per Cubic Yard of Concrete) |       |       |
|--------------------------------------|---|-------|-------|
|                                      | 1 ½ in.   | ¾ in. | ⅜ in. |
| 2,500 psi                            | 425   | 470   | 520   |
| 3,000 psi                            | 470   | 520   | 565   |
| 3,500 psi                            | 520   | 565   | 610   |
| 4,000 psi                            | 565   | 610   | 660   |
| 5,000 psi                            | 660   | 705   | 760   |

Subsection M4.02.01: Cement

Delete the second paragraph.

Subsection M4.02.14: Precast Units

Replace this subsection with the following:

**M4.02.14: Precast Concrete Highway Units**

The following Precast Concrete Highway Units shall meet the requirements specified herein:

- (a) Standard Temporary Barriers
- (b) Standard Permanent Barriers
- (c) Box Culverts (Spans ≤ 10 ft)
- (d) Catch Basins
- (e) Drainage Pipes (Non-Dry Cast)
- (f) Manholes
- (g) Retaining Wall Systems
- (h) Traffic Light Pole Bases
- (i) Luminaire Bases

**A. Materials.**

Materials shall meet the requirements specified in Section M4: Cement and Cement Concrete Materials, the following Subsections of Division III, Materials, and specified herein:

|   |          |
|---|----------|
| Self-Consolidating Concrete for Precast Products..... | M4.02.17 |
| High Performance Cement Concrete .....                | M4.06.1  |
| Reinforcing Bars .....                                | M8.01.0  |
| Epoxy Coated Reinforcing Bars.....                    | M8.01.7  |
| Galvanized Reinforcing Bars .....                     | M8.01.8  |
| Primer and Damp-Proofing.....                         | M9.09.0  |
| Liquid Penetrant/Sealant .....                        | M9.15.0  |

**1. Cement Concrete Mix Design Formulation.**

Fabricators shall report proposed mix design formulations onto the Department issued mix design sheet in its entirety and submit to the Department for evaluation. Mix design formulations shall be designed with precise proportions of constituent materials, yielding 27.0 ft<sup>3</sup> (1 cubic yard) of cement concrete. All required mix design targets shall be reported on the Department issued mix design sheet for each proposed mix design.

Cement concrete mix designs shall be classified and reported according to the specified compressive strength of the concrete structure ( $f_c$ ), nominal maximum aggregate size (NMAS), and mix type. The specified compressive strength of the concrete structure ( $f_c$ ) shall be identified from the construction standard specifications, contract document special provisions, and design plans. Nominal maximum aggregate size (NMAS) shall be determined from the combined aggregate system of the proposed mix design formulation, and is defined as the sieve size immediately above the first sieve size that cumulatively retains more than 10% by mass.

Proposed mix design formulations will be evaluated for quality and conformance to the requirements specified herein.

**a. High Performance Cement Concrete for Precast Concrete Barrier.**

Precast concrete barrier shall be fabricated with cement concrete meeting Section M4.06.1: High Performance Cement Concrete.

**b. Self-Consolidating Concrete.**

Precast concrete highway units fabricated with self-consolidating concrete shall meet Section M4.02.17: Self-Consolidating Concrete for Precast Products.

## **2. Cement Concrete Mix Design Verification Testing.**

Upon Department Acceptance of the mix design evaluation, Fabricators proposing new mix design formulations shall select an AASHTO accredited independent laboratory to conduct mix design verification testing. The sampling and testing conducted by the independent laboratory shall be witnessed by the Department. Fabricators shall report the source, type, quantity, and design target for each constituent material incorporated into the proposed mix design onto batch tickets meeting AASHTO M 157 Standard Specification for Ready-Mixed Concrete. Fabricators shall provide Batch tickets to the Department for review. Mix design verification test results shall be within the limits specified in Table M4.02.14-1. Proposed mix design formulations for high performance concrete shall meet the additional requirements specified in Section M4.06.1: High Performance Cement Concrete and self-consolidating concrete shall meet the additional requirements specified in Section M4.02.17: Self-Consolidating Concrete for Precast Concrete Products.

**Table M4.02.14-1: Mix Design Verification Testing Requirements**

| Property    | Method   | Quality Characteristic   |                 | Limits         |             |
|-------------|--|--|-----------------|----------------|-------------|
|             |  |  |                 | Min.           | Max.        |
| Uniformity  | T 119 <sup>[1]</sup>   | Slump (in.)  | < 4 in.         | Target -1.0    | Target +1.0 |
|             |  |  | 4 – 8 in.       | Target -1.5    | Target +1.5 |
|             | T 121 <sup>[1]</sup>   | Unit Weight (lb/ft <sup>3</sup> )  | For Information |                |             |
| Workability | T 119 <sup>[2]</sup>   | Segregation Resistance   |                 | Pass           |             |
| Thermal     | T 309  | Concrete Temperature (°F)  |                 | 50             | 90          |
| Strength    | T 22 <sup>[1]</sup> <sup>[3]</sup> <sup>[4]</sup>                    | Compressive Strength (psi)   | 3 Days          | -              | -           |
|             |  |  | 7 Days          | -              | -           |
|             |  |  | 28 Days         | f <sub>c</sub> | -           |
|             |  |  | 56 Days         | -              | -           |
| Durability  | T 358 <sup>[3]</sup>   | Surface Chloride Ion Penetration Resistance (kΩ-cm)                        | 7 Days          | -              | -           |
|             |  |  | 28 Days         | 15             | -           |
|             | T 121 <sup>[1]</sup><br>T 152 <sup>[1]</sup><br>T 196 <sup>[1]</sup> | Freezing, Thawing, and De-Icing Resistance: Air Content (%)                | Target -1.0     | Target +1.0    |             |
|             | C 1567   | Alkali Silica Reaction Resistance: Expansion of Accelerated Mortar Bar (%) | 14 Days         | M4.02.00       |             |

[1] Prior to mix design verification testing, the Cement Concrete Producer shall identify and report the proposed mix design targets onto the Department issued cement concrete mix design sheet. Any adjustments made to the proposed mix design targets shall be based on the verification test results, and are subject to Department approval and the requirements specified herein.

[2] Testing for segregation resistance shall be performed while the concrete is being discharged and during AASHTO T 119 Standard Method of Test for Slump of Hydraulic Cement Concrete. Visual signs of segregation include coarse particles advancing in front of or behind the fine particles and mortar and a tendency for coarse aggregate to separate from the mortar, particularly when the mixture is being consolidated.

[3] Three (3) 4 x 8 in. cylinders shall be cast for each set specified for maximum aggregate size less than 1-1/2 inches. Two (2) 6 x 12 in. cylinders shall be cast for each set specified for maximum aggregate size greater than 1 inch.

**3. Reinforcement for Precast Concrete Barrier.**

Reinforcement for precast concrete barrier shall meet Section M8.01.7: Epoxy Coated Reinforcing Bars or Section M8.01.8: Galvanized Reinforcing Bars, and Grade 60 of the AASHTO M 31 Standard Specification for Deformed and Plain Carbon and Low-Alloy Steel Bars for Concrete Reinforcement. The 1-in. plain dowel bars shall conform to ASTM A36 and shall be galvanized according to AASHTO M 111M/M 111.



## **B. Fabrication Methods.**

Precast Concrete Highway Units shall be fabricated by a Department approved precast or prestressed concrete Fabricator, under the controlled settings of the approved Fabricator's facility, with a Department approved mix design formulation, as specified herein. Fabricators and concrete mix design formulations shall maintain valid listing on the MassDOT Qualified Construction Materials List (QCML). Precast Concrete Highway Units shall be fabricated in conformance with:

- (a) MassDOT Standard Details and Drawings
- (b) Approved Shop Drawings
- (c) Latest edition of the American Association of State Highway and Transportation Officials (AASHTO) LRFD Bridge Construction Specifications
- (d) Latest edition of the National Precast Concrete Association (NPCA) Quality Control Manual for Precast Concrete Plants
- (e) Latest edition of the Precast Concrete Institute (PCI) MNL-116 Manual for Quality Control for Plants and Production of Structural Precast Concrete Products
- (f) Requirements specified herein

Circular vertical precast reinforced concrete manholes and structures used in sewer, drainage, and water works shall meet AASHTO M 199 Standard Specification for Precast Reinforced Concrete Manhole Sections. Reinforced concrete drainage pipes intended to be used for the conveyance of sewage, industrial wastes, and storm water shall meet AASHTO M 170 Standard Specification for Reinforced Concrete Culvert, Storm Drain, and Sewer Pipe.

### **1. Standard Drawings and Details.**

Prior to fabrication of precast concrete highway units, the Fabricator shall prepare shop drawings in accordance with:

- (a) MassDOT Construction Standard Details
- (b) Traffic Standard Drawings for Traffic Signals and highway Lighting
- (c) Signal Structure and Foundation Standard Drawings
- (d) Standard Drawings for Signs and Supports

### **2. Shop Drawings.**

Prior to fabrication of non-standard precast concrete highway units, the Fabricator shall prepare shop drawings in accordance with the relevant provisions of Subsection 5.02 and shall, at a minimum, contain the following, where applicable:

- (a) Fabricator's name and address on each sheet
- (b) Category and Type of Product, Unit Identification Number
- (c) Overall length, width, and height
- (d) Location, size, and geometry of all steel reinforcement, including mechanical reinforcing bar splicers to be used for connecting products together in the field (if called for on plans).
- (e) Location and details of all inserts, anchors, vertical adjustment assemblies, and any other items required to be cast into the product (whether detailed on the plans by the Engineer of Record or provided for the Contractor's convenience).
- (f) Locations and details of the lifting devices, including supporting calculations, type and amount of any additional reinforcing required for lifting. The Fabricator shall design all lifting devices based on the no cracking criteria in the latest edition of the PCI Design Handbook.
- (g) The minimum concrete compressive strength required prior to handling the product.
- (h) Specified concrete design compressive strength ( $f'_c$ ), Nominal Maximum Aggregate Size (NMAS), and Mix Type.

Proposed shop drawings shall be drawn to scale and submitted to the Engineer of Record for review and approval. The shop drawings shall not include procedures for placement, finishing, and curing of concrete. These details shall be included in the Fabricator's Quality Control Plan as specified herein.

### **3. Control, Handling, and Storage of Constituent Materials**

Fabricators shall verify the conformance of the constituent materials to specifications from Quality Control testing and Manufacturer certificates of compliance and meet the control, handling, and storage of constituent materials requirements specified herein.

#### **a. Hydraulic Cement and Supplementary Cementitious Materials.**

Hydraulic cement and supplementary cementitious materials shall be sufficiently controlled, handled, and stored through prevention of moisture absorption, cement caking, and contamination. Hydraulic cement and supplementary cementitious materials shall be stored in weathertight, sufficiently ventilated structures to prevent absorption of moisture. The interior of a cement silo shall be smooth, with a minimum bottom slope of 50 degrees from the horizontal for a circular silo and 55 to 60 degrees for a rectangular silo. Silos shall be equipped with non-clogging air-diffuser flow pads through which small quantities of dry, oil-free, low-pressure air can be introduced intermittently at approximately 3 to 5 psi to loosen cement that has settled tightly in the silos. Storage silos shall be drawn down once per month to prevent cement caking. Each bin compartment from which cement is batched shall include a separate gate, screw conveyor, air slide, rotary feeder, or other conveyance that allows both constant flow and precise cutoff to obtain accurate batching of cement.

Sources of contamination include incorrect sources placed into storage structures and dust contaminants. Storage structures shall be sufficiently labeled to avoid contamination. Contamination shall be sufficiently monitored and controlled during loading and transferring.

#### **b. Aggregate.**

Aggregate shall be sufficiently controlled, handled, and stored through prevention of gradation variation due to segregation and undersized particles, moisture content variation, contamination, degradation, and fracture.

##### **(1) Variation in Gradation.**

Aggregate gradation shall be sufficiently monitored to maintain control of the mix design. Aggregate shall be stockpiled in thin horizontal layers of uniform thickness to limit segregation. Storing aggregate in large conical stockpiles causes segregation and shall be prohibited. Segregation is limited when the coarse aggregate is further divided into several different sized sub-groupings with smaller ranges to be batched separately. Segregation in the coarse aggregate is controlled when the maximum aggregate size to the minimum aggregate size for a given aggregate size grouping is limited to a 4 to 1 ratio for maximum aggregate size less than 1 in. and is limited to a 2 to 1 ratio for maximum aggregate size greater than or equal to 1 in.

Undersized particles for a given coarse aggregate size grouping is defined as material passing the sieve size with an opening 5/6 of the nominal minimum size of the coarse aggregate size grouping. Coarse aggregate shall be rescreened as it is charged to the bins to remove undersized particles and undesirable fines if handling and storage methods are unsatisfactory and variations in gradation exceed allowable tolerances.

Storage bins (hoppers) shall be circular or nearly square and their bottoms shall slope more than 50 degrees from the horizontal on all sides to a center outlet. During bin loading, the aggregate shall be discharged directly above and fall vertically into the center of the bin. Discharging aggregate against the side of the bin or baffle wall causes segregation and shall be prohibited. Baffle plates or dividers can minimize segregation. Bins shall be filled to limit variation in gradation caused by withdrawal of material, segregation, and breakage of aggregate particles. Dry fine aggregate when dropped from buckets or conveyors shall be sufficiently shielded from wind and other external forces to prevent loss of fines. Fine aggregate may require dampening to prevent segregation of material.

## **(2) Variation in Moisture Content.**

Aggregate moisture content shall be sufficiently monitored to maintain control of the mix design. Coarse aggregate shall be wetted to keep the aggregate in a constantly saturated condition, to compensate for aggregate absorption, and to provide cooling. Aggregate shall be sufficiently dewatered and drained to form a uniform moisture content and to prevent transfer of excessive free water to the bins. Fine aggregate, due to its surface area, contributes the largest amount of free water added to the mix design. Moisture meters can indicate variations in the moisture of aggregate and moisture compensators can be used for rapid batch weight adjustments, to limit moisture variations in the aggregate. Aggregates washed to remove contaminants shall be stockpiled well before use so that they can drain to a uniform moisture content.

## **(3) Contamination.**

Sources of contamination include overlapping of different aggregate sizes from adjacent stockpiles, aggregate leakage through or around bulkheads in storage bins, underlying soil, dislodged clay lumps and other contaminants from transporting unit, leaves and vegetation, freezing aggregate, incorrect delivery from aggregate manufacturer, and incorrect aggregate size placed into a bin or stockpile. Stockpiles shall be placed on a hard base with sufficient drainage to prevent contamination from underlying material. Bulkheads, dividers, and partitions with sufficient height and ample spacing between piles shall be utilized to avoid cross-contamination and overlapping of different aggregate sources, types, and size groupings between stockpiles. Storage areas shall be sufficiently labeled to avoid contamination. Clay lumps or clay balls shall be removed from the aggregate by placing a scalping screen over the batch plant bin. Aggregate may require washing to remove contaminants. During cold temperatures, bins shall be covered or underground to prevent the freezing of aggregate. Frozen aggregate shall be prohibited from use. Aggregates may require heating to maintain an acceptable aggregate temperature and prevent freezing. Trucks, loaders, dozers, and other heavy transport equipment shall not be operated on the stockpiles due to the potential for aggregate particle fracture and contamination of track dirt onto the piles. Additional measures, including storage area coverings, shall be instituted in cases where storage areas are subject to other sources of contamination.

### **c. Mixing Water.**

Mixing water shall be sufficiently controlled, handled, and stored through prevention of contamination.

### **d. Chemical Admixtures.**

Chemical admixtures shall be sufficiently controlled, handled, and stored through prevention of contamination. Sources of contamination include freezing, evaporation, sunlight, and incorrect chemical admixture sources placed into chemical admixture tanks. Chemical admixtures shall be stored in heated environments to prevent freezing. Frozen chemical admixtures shall be reblended. Long-term storage of liquid admixtures in vented tanks shall be prohibited due to evaporation of the liquid negatively affecting the performance of the mix design. Certain chemical admixtures are prone to sunlight and shall be sufficiently protected in the storage tanks. Storage tanks shall be sufficiently labeled to avoid contamination. Chemical admixtures shall be stored in accordance to the chemical admixture manufacturer's recommendations.

## **4. Temperature Control.**

Concrete shall be batched, mixed, delivered, placed, finished, and cured with ambient temperatures greater than or equal to 40°F and less than or equal to 85°F. The temperature of plastic concrete shall be greater than or equal to 50°F and less than or equal to 90°F. At no point shall the temperature of the concrete exceed 158°F.

Temperature measuring devices shall record and report to the nearest 1°F. The Fabricator shall continuously monitor, record, and report the ambient temperatures surrounding the concrete without interruption, at a minimum frequency of once per hour, until 100% of  $f'c$  is attained. The Fabricator shall confirm all temperature requirements meet the specifications herein. Fabricator temperature monitoring records shall be provided to the Department upon request.

**5. Protection from Adverse Conditions.**

The concrete shall be protected from all adverse conditions, including precipitation, cold conditions, and hot conditions, until 100% of  $f_c$  is attained, as specified Section 901.64: Protection from Adverse Weather.

**6. Batching and Mixing.**

Equipment, measurement, tolerances, procedures, sequencing, and batch ticketing used for the batching and mixing of cement concrete shall meet the applicable standards of AASHTO M 157 Standard Specification for Ready-Mixed Concrete, Concrete Plant Manufacturers Bureau (CPMB), Truck Mixer Manufacturers Bureau (TMMB), National Institute of Standards and Technology (NIST), and the requirements specified herein.

Weigh batch equipment shall be categorized as manual, partially automatic, semiautomatic, and fully automatic. Scales and volumetric devices for measuring quantities of constituent materials shall be calibrated for accuracy through certified field standard weights and product substitute loading. Scales shall be accurate to the greater of  $\pm 0.15\%$  of the scale capacity or  $\pm 0.4\%$  of the applied test load in all quarters of the scale capacity through its range of use. The accuracy of scales and batching equipment shall be inspected routinely and adjusted when necessary. Equipment shall be isolated from plant vibration. Automatic controls shall be protected from dust and weather. Scale and beam pivot points shall be routinely inspected and cleaned. Equipment shall operate within the specified batch-weight tolerances specified in Table M4.02.14-2. Equipment shall be made accessible to the Department for inspection.

**Table M4.02.14-2: Allowable Batching Tolerances of Mix Design Target Weights**

| Specification | Constituent Material  | Batch Weights > 30% of Scale Capacity                            |                                | Batch Weights $\leq$ 30% of Scale Capacity                    |  |
|---------------|---|--|--------------------------------|---|--|
|               |   | Individual Batching Tolerances                                   | Cumulative Batching Tolerances | Individual Batching Tolerances                                | Cumulative Batching Tolerances                               |
| <b>M 157</b>  | Hydraulic Cement (%)  | $\pm 1.0$ or $\pm 0.3\%$ of scale capacity, whichever is greater |                                | Not less than required weight or 4% more than required weight |  |
|               | Hydraulic Cement + Supplementary Cementitious Materials (%) | $\pm 1.0$ or $\pm 0.3\%$ of scale capacity, whichever is greater |                                | Not less than required weight or 4% more than required weight |  |
|               | Aggregate (%)   | $\pm 2.0$  | $\pm 1.0$                      | $\pm 2.0$   | $\pm 3.0$ or $\pm 0.3\%$ of scale capacity whichever is less |
|               | Mixing Water (%)  | $\pm 1.0$  | Prohibited                     | $\pm 1.0$   | Prohibited   |
|               | Chemical Admixtures (%)                                     | $\pm 3.0$  | Prohibited                     | $\pm 3.0$   | Prohibited   |

Cement concrete shall be mixed by stationary mixers, truck mixers, volumetric (continuous) mixers, or portable mixers. Cement concrete shall be mixed thoroughly until the constituent materials are uniformly distributed. Mixers shall be adequately designed with blade or fin arrangements and drum shapes that ensure an end-to-end exchange of materials parallel to the axis of rotation or a rolling, folding, and spreading movement of the batch over itself as it is being mixed. Mixing blades shall be free of wear and hardened concrete.

Modifications to Department approved mix design formulations, including source of constituent materials, design quantities, mix type, combined aggregate system targets, paste system targets, slump targets, air content targets, and compressive strength targets shall be prohibited. However, if slump or air content test results are not within the specified design target ranges, the Fabricator is permitted to submit to the Department a request to review and approve proposed adjustments of chemical admixture dosages. At no point shall the total water or water-cementitious (w/cm) ratio exceed the approved mix design formulation targets. The Producer shall report the adjustments onto the batch ticket. Chemical admixture adjustments without Department approval shall be prohibited. Department approval is subject to performance at the plant, as well as conformance to the requirements specified herein.

#### **7. Formwork.**

Precast Concrete Highway Units shall meet Section 901.61: Forms, Falsework, and Centering and PCI Manual 116-21, Section 2.4 Forms/Molds. Precast concrete barrier shall be cast with the forms in a 180° inverted position and compacted with an approved vibrator.

#### **8. Reinforcement.**

Precast Concrete Highway Units shall meet Section 901.62: Reinforcement and the reinforcement materials requirements specified herein.

#### **9. Handling and Placing of Concrete.**

Precast Concrete Highway Units shall meet Section 901.63: Handling and Placing Concrete.

#### **10. Finishing.**

As-cast formed surface finishes shall be acceptable in appearance, color, and texture. Exposed unformed surface finishes shall be finished by screeding or floating, unless otherwise noted. Under no circumstances shall bleed water or initial curing materials be worked into the surface. The addition of water, spreading of cement, or the use of unacceptable tools, including steel trowels and fresnos to the surface of the concrete shall be prohibited. The concrete shall not be overworked, to prevent premature degradation from excess water and fine material rising to surface. Defects shall be addressed per Section M4.02.14,B.,15: Repairs and Replacement.

#### **11. Final Curing.**

Final curing materials, methods, and procedures shall be applied to all exposed cement concrete surfaces immediately after the completion of finishing operations and final set to prevent the loss of moisture and surface drying. Exposed surfaces from form removal shall be wetted immediately and kept moist until final curing materials are applied.

Final curing materials applied to the concrete shall allow the concrete to mature sufficiently to achieve its designed and desired properties, including strength, volume stability, permeability, durability, and resistance to freezing, thawing, and de-icing cycles. Curing water shall be free of deleterious impurities, causing staining and deterioration. The potential staining ability of curing water shall be evaluated by means of US Army Corps of Engineers CRD-C401 Method of Test For The Staining Properties of Water for instances where curing water quality is questioned.

The Fabricator shall maintain a continuous application of moisture or moisture retention throughout the entire duration of the final curing method cycle and meet the minimum sustained ambient temperature, concrete temperature, duration, and strength requirements as specified herein. Controlled, gradual, and uniform termination of the final curing method cycle shall begin only after all specified conditions are met. The concrete temperature shall be reduced at a rate not to exceed 36°F per hour until the concrete temperature is within 20°F of the ambient temperature.

Termination of final curing methods shall not occur until both the duration and compressive strength requirements are met, as specified in Table M4.02.14-2.

**Table M4.02.14-3: Termination of Final Curing Method**

| Product Categories   | Methods   | Duration | Compressive Strength |
|--|---|----------|----------------------|
| Precast Concrete Highway Products (Excluding Barrier)  | Form Cure <sup>[1]</sup>  | -        | ≥ 70% of $f'_c$      |
| Precast Concrete Barrier   | Liquid Membrane-Forming Compounds <sup>[2]</sup><br>Saturated Covers<br>Sheet Materials | ≥ 3 Days | ≥ 80% of $f'_c$      |
|  | Curing Water Nozzles  | ≥ 5 Days |                      |
| <p>[1] Final curing materials, methods, and procedures shall be applied to all exposed surfaces not being cured by the form.</p> <p>[2] If the liquid membrane-forming compound is to be removed due to compatibility or bonding concerns, removal shall not take place until the specified application duration is met.</p> |   |          |                      |

Concrete cured by way of curing water nozzles, saturated covers, sheet materials, or liquid membrane-forming compounds shall be cured with sustained ambient temperatures greater than or equal to 40°F and less than or equal to 85°F.

Curing water shall not exceed a temperature differential of more than 20°F from the internal concrete temperature, to prevent cracking due to temperature gradients causing strain that exceeds the strain capacity of concrete. Curing water shall remain above freezing temperatures throughout the duration of the curing cycle. Compressive strength cylinders for termination of curing cycle shall be cast and field cured with the same environmental conditions that the concrete is subjected to throughout the entire duration of the curing cycle.

All procedures, operations, materials, and equipment required for adequate curing shall be present and ready for use prior to concrete production.

**a. Curing Water Nozzles.**

Curing water nozzles shall provide the surface of cement concrete with a continuous fine spray of water.

**b. Saturated Covers.**

Saturated covers shall meet AASHTO M 182, Class 3. Saturated covers shall be in good condition, free from holes, tears, or other defects that would render it unsuitable for curing cement concrete. Saturated covers shall be dried to prevent mildew when storing. Saturated covers shall be of sufficient thickness to maximize moisture retention. Saturated covers shall be free of harmful substances that are deleterious or cause discoloration to cement concrete and cementitious materials. Saturated covers shall have the ability to retain sufficient moisture from continuous watering so that a film of water remains on the surface of cement concrete.

Prior to application, saturated covers shall be thoroughly rinsed in water and free of harmful substances that are deleterious or cause discoloration to cement concrete. The Fabricator shall maintain sufficient moisture with continuous watering so that a film of water remains on the surface of the cement concrete throughout the entire duration of the final curing method cycle. Saturated covers shall be properly positioned, secured, and maintained on the surface of the concrete to maximize moisture retention and to prevent moisture loss. The Fabricator shall prohibit saturated covers from drying out and prevent the absorption of curing water from the surface of the concrete. Polyethylene film may be applied over the saturated cover to limit the amount of continuous watering required for sufficient moisture retainage.

**c. Sheet Materials.**

Sheet materials shall meet ASTM C171 Standard Specification for Sheet Materials for Curing Concrete. Sheet materials shall inhibit moisture loss and reduce temperature rise in concrete exposed to radiation from the sun. Adjoining sheet materials shall overlap not less than 12 inches. All edges of the sheet materials shall be secured to maintain a moist environment.

**(1) Polyethylene Film.**

Polyethylene film shall be clear, white, or black in color and consist of a single sheet manufactured from polyethylene resins, be free of visible defects, including tears, wrinkles, and discontinuity. The film shall prohibit mottling and uneven spots from appearing on the surface of concrete, due to variations in temperature, moisture content, or both. Polyethylene film shall accommodate concrete surfaces with constant contact without damage. White polyethylene film shall minimize heat gain caused by absorption of solar radiation. Clear and black polyethylene films shall inhibit absorption of solar radiation and be exclusively applied during cold conditions.

The Fabricator shall prohibit mottling and uneven spots from appearing on the surface of concrete, due to variations in temperature, moisture content, or both. Application of additional curing water under the film or application of a polyethylene film bonded to absorbent fabric to the concrete surface may be required to prevent mottling and to retain and evenly distribute the moisture. The Polyethylene film shall be applied to concrete surfaces with constant contact without damage. The film shall extend beyond the edges of the concrete surface. Edges of adjacent polyethylene film shall overlap a minimum of 6 inches and be tightly sealed with the use of sand, wood planks, pressure-sensitive tape, mastic, or glue to maintain close contact with the concrete surface, retain moisture, and prevent the formation of air pockets.

**(2) White Burlap-Polyethylene Sheeting.**

White burlap-polyethylene sheeting shall be securely bonded to the burlap so to avoid separation of the materials during handling and curing of the concrete.

**(3) Reinforced Impervious Paper.**

Reinforced impervious paper shall be white in color, consist of two sheets of kraft paper cemented together with a bituminous adhesive, and reinforced with embedded cords or strands of fiber running in both directions. Reinforced impervious paper shall be free of holes, tears, and pin holes from deterioration of the paper through repeated use. Reinforced impervious paper shall be treated to prevent tearing when wetted and dried. Reuse of reinforced impervious paper shall be permitted so long as it is able to retain moisture on the surface of concrete. The paper shall be discarded and prohibited from use when moisture is no longer retained in the material.

**d. Liquid Membrane-Forming Compounds.**

Liquid membrane-forming compounds, including compounds with curing properties and compounds with both curing and sealing properties, shall maintain valid listing on the Department Qualified Construction Materials List (QCML) and meet the requirements specified herein.

Compounds shall form a continuous, non-yellowing, and durable film with quality moisture-retention properties. Compounds shall maintain the relative humidity of the concrete surface above 80% for greater than or equal to three (3) days to sustain cement hydration. Compounds shall not affect the original color of the concrete surface. Compounds shall not degrade due to exposure to ultraviolet light from direct sunlight. Compounds shall meet the local and federal allowable Volatile Organic Compound (VOC) content limits.

Liquid membrane-forming compounds shall be applied per the Manufacturer's instructions and recommendations as specified herein. Prior to use, compounds shall be thoroughly mixed, stirred, and agitated. Compounds shall be applied immediately after final finishing and the disappearance of the surface water sheen, but before the free water on the surface has evaporated, to prevent the formation of cracks and loss of moisture at the surface. Careful considerations shall be made by the Fabricator to determine if the evaporation rate is exceeding the rate of bleeding, thus causing the surface to appear dry even though bleeding is still occurring. To diagnose and prevent this condition, the Fabricator shall place a transparent plastic sheet over a test area of the uncured and unfinished concrete surface and shall determine if any bleed water accumulates under the plastic. Under such conditions, the application of liquid membrane-forming compounds to the concrete surface shall be delayed to prevent bleed water from being sealed below the concrete surface, map cracking of the membrane films, reduction in moisture-retention capability, and the need for reapplication of the compound.

When using compounds to reduce moisture loss from formed surfaces, the exposed surface shall be wetted immediately after form removal and kept moist until the compound is applied. The concrete shall be allowed to reach a uniformly damp appearance with no free water on the surface, and then application of the compound shall begin at once. Delayed application resulting in surface drying, absorption of the compound into the concrete, and forming of a discontinuous membrane shall be prohibited.

The concrete surface shall be damp when the compound is applied. Power-driven spray equipment shall be used for uniform application of compounds on large paving projects. Spray nozzles recommended by the compound Manufacturer and use of windshields shall be arranged by the Fabricator to prevent wind-blown loss of compound and to ensure proper coverage application rates are achieved. The compound shall be applied by power sprayer, using appropriate wands and nozzles with pressures between 25 and 100 psi. The Fabricator shall fill the power sprayer with curing compound from the Manufacturer's original container in the presence of the Engineer. Any dilution as recommended by the Manufacturer shall take place in the presence of the Engineer. For very small areas such as repairs, the compound shall be applied with a wide, soft-bristled brush or paint roller.

The Fabricator shall verify the application rate and procedures are in accordance with the Manufacturer's instructions and recommendations. At least one uniform coat shall be applied at a rate of 150 to 200 ft<sup>2</sup>/gallon. On very deeply textured surfaces, the surface area to be treated shall be at least twice the surface area of the surface. In such cases, two separate applications may be needed, each at 200 ft<sup>2</sup>/gallon or greater if specified by the Manufacturer to achieve the desired moisture retention rate, with the first being allowed to become tacky before the second is applied. If two coats are necessary to ensure complete coverage, for effective protection the second coat should be applied at right angles to the first. Complete coverage of the surface shall be attained due to the potential for formation of small pinholes in the membrane, which will result in loss of moisture from the concrete. Compounds shall not sag, run off peaks, or collect in grooves.

Compounds and procedures shall be compatible with concrete surfaces receiving subsequent applications or placements of concrete, overlays, coatings, paints, sealers, finishes or other toppings to ensure acceptable bonding to the concrete. Testing to establish compatibility among the curing compound, subsequent surface treatments, concrete moisture content and the actual finished surface texture of the concrete shall be conducted when compatibility is not known. The compound Manufacturer shall be consulted by the Fabricator to determine the compatibility of the application. Compounds shall not be applied to concrete surfaces where bonding of subsequent applications or placements is incompatible or is of concern. The use of wax-based curing compounds shall be prohibited in instances where concrete surfaces are subject to additional toppings and vehicular, pedestrian, or other traffic.

Deliberate removal of compounds in the presence of the Engineer and in accordance with Manufacturer's instructions and recommendations shall be conducted as an alternative to compatibility testing, incompatibility, or in instances where bonding is of concern. Bonding of subsequent materials may still be inhibited by the presence of the compound even after the moisture retention characteristics of the compound have diminished.

White-pigmented compounds shall be used in instances where solar-heat gain is concern to the concrete surface. White-pigmented compounds shall be agitated in the container prior to application to prevent pigment from settling out resulting in non-uniform overage and ineffective curing.



**(1) Liquid Membrane-Forming Compounds for Curing.**

Liquid membrane-forming compounds for curing shall meet ASTM C309 Standard Specifications for Liquid Membrane Forming Compounds for Curing Concrete and the requirements specified herein.

*Table M4.02.14-4: Types*

| Type     | Description                            |
|----------|--|
| Type 1   | Clear or translucent without dye       |
| Type 1-D | Clear or translucent with fugitive dye |
| Type 2   | White pigmented                        |

*Table M4.02.14-5: Composition Classification*

| Type    | Description  |
|---------|--|
| Class A | Unrestricted composition, generally wax-based products |
| Class B | ASTM D883 resin-based products                         |

**(2) Liquid Membrane-Forming Compounds for Curing and Sealing.**

Liquid membrane-forming compounds for curing and sealing shall meet ASTM C1315 Standard Specification for Liquid Membrane-Forming Compounds Having Special Properties for Curing and Sealing Concrete and the requirements specified herein. The protective sealing requirements specified in M4.02.14, .B.16 do not apply to cement concrete surfaces previously applied with liquid membrane-forming compounds for curing and sealing.

In addition to moisture-retention capabilities compounds shall exhibit specific properties, including alkali resistance, acid resistance, adhesion-promoting quality, and resistance to degradation by ultraviolet light.

*Table M4.02.14-6: Types*

| Type    | Description          |
|---------|----------------------|
| Type I  | Clear or translucent |
| Type II | White pigmented      |

*Table M4.02.14-7: Classification*

| Type    | Description   |
|---------|---------------|
| Class A | Non-yellowing |

**12. Form Removal.**

The Fabricator shall not remove forms from the concrete until compressive strength cylinders attain 70% of  $f'_c$ . Compressive strength cylinders for removal of forms shall be cast and field cured with the same environmental conditions that the concrete is subjected to throughout the entire duration of the operation. Immediately following form removal, all exposed concrete surfaces shall be prepared and cured per the requirements specified in.

### **13. Handling and Storage of Concrete Products.**

Precast Concrete Highway Units shall not be handled until form removal strength has been attained. Concrete products shall be lifted at the designated points by approved lifting devices embedded in the concrete and in accordance with proper lifting and handling procedures. Storage areas shall be smooth and well compacted to prevent damage due to differential settlement. Concrete products shall be supported on the ground by means of continuous blocking, in conformance with the approved dunnage plan. The concrete shall be protected from all adverse conditions, including precipitation, cold conditions, and hot conditions, until 100% of  $f'_c$  is attained, as specified Section 901.64: Protection from Adverse Weather.

### **14. Primer and Damp-Proofing of Precast Concrete Drainage Structures.**

The Fabricator shall apply primer and damp-proofing materials, methods, and procedures to the outside surface of the tapered or cone section of precast concrete drainage structures. Precast concrete drainage structures shall be damp-proofed in accordance with Section 970: Damp-Proofing.

### **15. Repairs and Replacement.**

Defects identified during inspection shall be classified in the following categories and a non-conformance report (NCR) shall be initiated if required. The NCR shall be submitted to the Department for review and approval of the Fabricator's proposed NCR disposition. Defects shall be repaired per the approved NCR disposition, with approved materials listed on the MassDOT Qualified Construction Materials List (QCML), according to the PCI Northeast Region Guidelines for Resolution of Non-Conformances in Precast Concrete Bridge Elements, Report Number PCINE-18-RNPCBE, at the expense of the Contractor. Defects requiring Non-Conformance Report (NCR) submission shall be repaired in the presence of Department personnel. All defects regardless of category shall be documented by Quality Control personnel and made available to the Department upon request.

#### **a. Category 1 Surface Defects.**

Category 1 defects do not require repair or Non-Conformance Report (NCR) submission. However, documentation of the identified defects is required by the Fabricator. Surface defects are defined as the following:

- (a) Surface voids or bug holes that are less than 0.625 inches in diameter and less than 0.250 inches in depth, except when classified as Category 3
- (b) Cracks less than or equal to 0.006 inches in width

#### **b. Category 2 Minor Defects.**

Category 2 defects shall be documented. Repairs shall be documented, however, NCR submission is not required by the Fabricator. Minor defects are defined as the following:

- (a) Spalls, honeycombing, surface voids that are less than 2 inches in depth and have no dimension greater than 12 inches
- (b) Cracks greater than 0.006 inches and less than or equal to 0.060 inches in width (cracks shall be sealed according to the PCI Repair Procedure #14 in PCINE-18-RNPCBE)
- (c) Broken or spalled corners without exposed reinforcing steel

#### **c. Category 3 Rejectable Defects.**

Category 3 defects may be cause for rejection, as determined by the Engineer. Category 3 defects shall be documented and reported on the NCR and submitted to the Department. The Fabricator may include proposed repair procedures on the submitted NCR for Department review. However, if the proposed repair procedures are not accepted by the Department, the Precast Concrete Highway Unit shall be rejected. If accepted, proposed repair procedures shall not takeplace prior to Department approval. Rejectable defects are defined as the following, including, but not limited to:

- (a) Surface defects on more than 5% of the surface area
- (b) Minor defects that in total make up more than 5% of the surface area of the unit
- (c) Concentrated area of defects consisting of four or more Category 2 Defects within a 4-square foot area.

- (d) Exposed reinforcing steel
- (e) Spalls, honeycombing and surface voids that are deeper than 2 inches or have any dimension greater than 12 inches, when measured along a straight line
- (f) Cracks greater than 0.060" in width
- (g) Elements fabricated outside of the specified tolerances
- (h) Compressive strength that does not meet  $f'_c$

#### **16. Protective Sealing Compounds for Precast Concrete Barrier.**

The protective sealing requirements specified herein do not apply to cement concrete surfaces previously applied with liquid membrane-forming compounds for curing and sealing.

Protective sealing compounds meeting Section M9.15.0: Liquid Penetrant/Sealant shall be applied to precast concrete barrier per the Manufacturer's instructions and recommendations as specified herein. Protective sealing compounds shall not be applied to concrete while conditions meeting Section 901.64: Protection from Adverse Weather are present.

Curing materials, methods, and procedures shall be applied to the concrete prior to the application of protective sealing compounds. The surface shall be sufficiently prepared, clean, and dry for at least 24 hours with ambient temperatures exceeding 60°F. Protective sealing compounds shall not be applied to the concrete for a minimum of 28 days after the concrete is poured, unless otherwise noted in the manufacturer's instructions and recommendations. Periodic re-application shall be required for protective sealing compounds requiring multiple applications and for concrete surfaces exhibiting wear to ensure long-term protection of the concrete surface.

#### **17. Prior to Loading.**

Prior to the loading the concrete product on to the truck for shipping, the Fabricator shall provide the MassDOT Plant Inspector and RMS a minimum seven-day notice of the Fabricator's intent to load the concrete product. Inspection by the MassDOT Plant Inspector shall take place while the element is still on dunnage in the yard. The unit shall not be loaded onto the truck until the MassDOT Plant Inspector has performed the inspection.

#### **18. Loading.**

Concrete products shall be loaded on a trailer with continuous blocking, in accordance with the approved dunnage plan. Shock-absorbing cushioning material shall be used at all bearing points. Blocking shall be provided at all locations of tie-down straps. Concrete products shall not be subjected to damaging torsional or impact stresses.

#### **19. Shipping.**

Prior to shipment, the Fabricator shall perform the following actions and provide the required documentation to the MassDOT Plant Inspector:

- (a) Precast Concrete Highway Units shall remain at the Fabricator's plant for a minimum of 7 days after cast date.
- (b) QC Inspection Reports shall be signed by the Quality Control Manager and provided to the MassDOT Plant Inspector.
- (c) QC Compressive Strength Test Report Forms attaining Design Strength,  $f'_c$  for the Precast Concrete Highway Unit's representative Sublot shall be generated by the Fabricator and provided to the MassDOT Plant Inspector.
- (d) Certificate of Compliance shall be generated by the Fabricator as described under the Fabricator Quality Control section and provided to the MassDOT Plant Inspector.
- (e) All Department approved Corrective Actions submitted on the Non-Conformance Reports (NCR), shall be verified to have been completed by the MassDOT Plant Inspector and Quality Control Manager.
- (f) All NCRs shall be signed off by the Quality Control Manager and the Department Inspector and/or MassDOT RMS.
- (g) QC Inspection Stamp shall be applied to each unit after loading.

## 20. Delivery.

Upon Delivery, the following documentation shall be provided to the Engineer:

- (a) QC Compressive Strength Test Report Forms attaining Design Strength,  $f_c$  for the Precast Concrete Highway Unit's representative Sublot.
- (b) Certificate of Compliance generated by the Fabricator as described under the Fabricator Quality Control section.
- (c) QC Inspection Reports signed by the Quality Control Manager.

The Contractor shall inspect the concrete product upon receipt at the site. Concrete products damaged during delivery shall be repaired or replaced per the Department direction, at the Contractor's expense.

### C. Quality Assurance.

Quality Assurance is the planned and systematic actions necessary to provide confidence that a product or facility will perform satisfactorily in service. The Quality Assurance Program is comprised of the six core elements including Contractor Quality Control, Department Acceptance, Independent Assurance, Dispute Resolution, Laboratory Accreditation and Qualification, Personnel Qualification and Certification. The Fabricator shall conduct Quality Control (QC) and the Department will conduct Acceptance throughout the fabrication process, independently from one another.

The quality of the material or product shall be determined through quality measurements from sampling, testing, and inspection. The sampling population for quality measurements shall be comprised of lots and sublots. A lot shall be defined as a specific quantity of material from a single source which is assumed to be produced or placed by the same controlled process. Lots shall be used to represent the population of the produced material and constructed product. The lot size shall be the specified quantity of material produced and placed. A subplot shall be defined as a subdivision of a lot. Sublots shall be used to assess the inspection attributes and quality characteristics of the lot. The subplot size shall be the specified subdivision of quantity for a given lot.

The sampling population for testing and inspection shall be randomly sampled in accordance with ASTM D3665 Standard Practice for Random Sampling of Construction Materials. Random sampling is defined as a small quantity of material or measurement obtained from a lot or subplot, whereby each sample obtained from the lot or subplot has an equal probability of being selected. Selective (non-random) sampling may also be conducted to provide supplemental information to assist in maintaining control of all production and placement processes. Selective sampling shall not replace random sampling and shall not be used in the Department Acceptance decision.

#### 1. Fabricator Quality Control.

Quality Control (QC) shall be established, maintained, and performed by the Fabricator to monitor, assess, and adjust manufacturing, production, fabrication, and construction processes, to maintain continuous control of the process, and to ensure that the final material or product will meet the specified level of quality, through:

- (a) Implementation of the Department approved Quality System Manual (QSM)
- (b) Proper Quality Control organization
- (c) Qualified Production Personnel, including equipment operators and craftsmen incorporated into the manufacturing, production, fabrication, and construction operations
- (d) Certified Quality Control Technicians and Quality Control Managers
- (e) Qualified Quality Control laboratory through the NETTCP Laboratory Qualification Program or accredited through the AASHTO Accreditation Program (AAP)
- (f) Routine QC inspection of equipment, environmental conditions, materials, and workmanship
- (g) Routine QC sampling and testing of material quality characteristics and properties
- (h) Timely analysis of QC results, through statistical analysis (mean, standard deviation, etc), control charts, and conformance to allowable limits
- (i) Immediate initiation of non-conformance reporting and corrective action for non-conforming inspection results, uncontrolled processes, and materials with test results not within allowable limits
- (j) Retention of QC records
- (k)** Conformance to specifications

**a. Quality Control Operating Documents.**

Quality Control operating documents shall be prepared, implemented, and maintained by the Fabricator and submitted to the Department for review and approval prior to the start of fabrication. The Fabricator shall adhere to all policies, practices, procedures, and activities identified in the following Department approved Quality Control operating documents.

**(1) Quality System Manual.**

The Fabricator shall submit a Quality System Manual (QSM) for Department review and approval. The Quality System Manual (QSM) shall document the overall internal Quality Control operating procedures of the Producer's Quality Control System and meet AASHTO R 18 Standard Recommended Practice for Establishing and Implementing a Quality Management System for Construction Materials Testing Laboratories, AASHTO R 38 Standard Practice for Quality Assurance of Standard Manufactured Materials, and the requirements specified by the Department.

**(2) Quality Control Plans for Contract Work Items.**

When applicable, a Quality Control Plan (QCP) shall be prepared for each contract work item by the Fabricator to document all Quality Control personnel and procedures utilized to maintain control of all production and placement processes. The Quality Control Plan for each contract work item shall meet the NorthEast Transportation Training and Certification Program (NETTCP) Model Quality Control Plan standard format and requirements specified by the Department.

**b. Fabricator Plant Certification.**

At a minimum, the Fabricator shall maintain an active National Precast Concrete Association (NPCA) Plant Certification or Precast/Prestressed Concrete (PCI) Plant Certification.

**c. Quality Control Laboratory.**

The Fabricator shall have all required sampling, testing, and inspection equipment on site and available for use during all phases of fabrication. The equipment shall meet all applicable AASHTO or ASTM standards, maintain required calibration schedules, and be in acceptable working condition.

The Fabricator shall provide a room of sufficient size to house all equipment and to adequately perform all required testing. The room shall include a desk and file cabinet for proper record keeping and have good lighting and ventilation. This room shall be kept for testing and quality control and not used for any other purpose. An additional desk and file cabinet shall be provided for exclusive use of the Engineer.

**d. Quality Control Organization.**

The Fabricator's Quality Control organization shall be comprised of trained, experienced, and qualified Production Personnel, Quality Control Technicians, and Quality Control Managers at the Fabricator's plant, per NPCA and/or PCI and as specified herein. Production Personnel, Quality Control Technicians, and Quality Control Managers shall maintain continuous communication to ensure conformance to specification requirements and to dictate corrective action for non-conformance.

**(1) Production Personnel.**

Production Personnel that are directly responsible for the fabrication of Precast Concrete Highway Units shall be comprised of sufficiently trained, qualified, and experienced craftsmen, equipment operators, foremen, and superintendents. Best practices meeting Department recognized standards, organizations, and programs and requirements specified herein shall be performed by Production Personnel throughout the entire fabrication process.

In addition to the fabrication activities, Production Personnel shall perform continuous self-inspection throughout the entire construction operation, to ensure quality workmanship is performed, through observation and verification of:

- (a) Proper tools and equipment are utilized to perform the work
- (b) Routine maintenance, calibration, and cleaning of tools and equipment is performed
- (c) Proper procedures for shipping, handling, and storage of materials are performed
- (d) Best practices for workmanship are incorporated throughout the construction operation
- (e) Quality appearance of finished material or product

Production Personnel shall be capable of identifying unacceptable materials and products prior to completing the construction operation and shall notify potential non-conformances to the Quality Control Technicians and Quality Control Manager. The Fabricator shall provide continual education, training, and qualification opportunities to Production Personnel to promote quality workmanship practices.

## **(2) Quality Control Technicians.**

Each Quality Control Technician shall be sufficiently trained, qualified, and certified through Department recognized qualification and certification programs or through relevant experience acceptable to the Department.

The Fabricator's Quality Control organization shall include an acceptable number of experienced, trained, and qualified Quality Control Technicians at the Production Facility. The number of Quality Control Technicians shall be determined according to the size of the production operation and the volume of material or product manufactured, produced, or fabricated for each work item. The principle responsibilities of each Production Facility Quality Control Technician include:

- (a) Performing Quality Control sampling, testing, and inspection at the production facility
- (b) Preparing and signing standard Quality Control test and inspection report forms
- (c) Providing routine feedback based on sampling, testing, and inspection results to the Production Personnel, Production Facility Quality Control Manager, and Prime Contractor Quality Control Manager

At a minimum, Quality Control Technicians shall maintain an active American Concrete Institute (ACI) Concrete Field Testing Technician – Grade I certification and Concrete Strength Testing Technician certification. Quality Control Technicians shall be on site and present during all phases of fabrication.

## **(3) Quality Control Manager.**

The principal responsibilities of each Quality Control Manager shall include:

- (a) Establishing the Quality Control system in accordance with the company's Quality System Manual (QSM)
- (b) Preparing Quality Control Plans (if applicable)
- (c) Managing and monitoring the activities of Quality Control technicians
- (d) Communicating routinely with production personnel
- (e) Initiating work suspension and corrective action in instances where materials or products are non-conforming or a process is not in control.
- (f) Ensuring proper Quality Control documentation and records retention

At a minimum, the Fabricator's Quality Control Manager shall meet the following requirements:

- (a) Maintain an active ACI Concrete Field Testing Technician – Grade I Certification
- (b) Maintain an active NETTCP Quality Assurance Technician Certification
- (c) A minimum of six (6) months continuous experience in the fabrication of precast concrete highway products

Quality Control Managers shall be employed full-time (or engaged consultants), on site, and present during all phases of fabrication.

**e. Quality Control Inspection.**

Quality Control inspection shall be performed by qualified Production Personnel and Quality Control Technicians to visually inspect equipment, environmental conditions, materials, and workmanship, per the Department approved Quality Control documents and specified herein. The results and findings of QC inspection shall be documented on the Fabricator’s Inspection Report Forms (IRFs). The Fabricator shall conduct immediate initiation of non-conformance reporting and corrective action for non-conforming inspection results and uncontrolled processes.

**f. Quality Control Sampling and Testing.**

Quality Control sampling and testing shall be performed and reported by qualified Quality Control Technicians, to provide measurement of properties and quality characteristics of the material, to determine the degree of uniformity or the measured variability of materials or products, to monitor the quality and acceptability of the material or product, and to evaluate the control during the production or placement process, per the Department approved Quality Control documents and specified herein. The minimum QC sampling and testing activities shall be in accordance with the requirements specified herein. The results and findings of QC sampling and testing shall be documented on the Fabricator’s Test Report Forms (TRFs). The Fabricator shall conduct immediate initiation of non-conformance reporting and corrective action for materials with test results not within allowable limits.

**(1) Aggregate Sampling and Testing.**

The Fabricator shall conduct routine Quality Control sampling and testing of aggregate quality characteristics and properties, to ensure uniformity and consistency of the material per the requirements specified herein.

**Table M4.02.14-8: QC Sampling and Testing Requirements for Aggregate**

| Method | Quality Characteristic              |
|--------|-------------------------------------|
| T 27   | Particle Size Distribution          |
| T 84   | Bulk Specific Gravity Dry           |
| T 85   | Bulk Specific Gravity SSD           |
|        | Apparent Specific Gravity           |
|        | Absorption (%)                      |
| T 19   | Unit Weight (lb / ft <sup>3</sup> ) |
|        | Aggregate Void Content (%)          |
| T 255  | Moisture Content (%)                |

**(2) Concrete Production Sampling and Testing.**

Quality Control sampling and testing shall be conducted during production per the minimum requirements specified herein. Production test results shall be within the limits specified herein.

**Table M4.02.14-9: QC Sampling and Testing Frequency During Concrete Production**

| Lot Size  | Sublot Size | Frequency   |
|---|-------------|---|
| Total quantity of concrete (cy) produced in a year, per approved mix design formulation | 50 cy       | One (1) per sublot or fraction thereof, minimum One (1) per day |

**Table M4.02.14-10: QC Sampling and Testing Requirements During Production**

| Property             | Method   | Quality Characteristic                       |                                | Limits                          |             |
|----------------------|--|--|--------------------------------|---------------------------------|-------------|
|                      |  |  |                                | Min.                            | Max.        |
| Uniformity           | M 157 <sup>[1]</sup>   | Batching Quantities of Constituent Materials |                                | Table M4.07.0-4                 |             |
|                      | T 119 <sup>[2][3]</sup>  | Slump (in.)                                  | < 4 in.                        | Target -1.0                     | Target +1.0 |
|                      |  |  | 4 – 8 in.                      | Target -1.5                     | Target +1.5 |
| T 121 <sup>[2]</sup> | Unit Weight (lb/ft <sup>3</sup> )                                    |  | For Information                |                                 |             |
| Workability          | T 119 <sup>[4]</sup>   | Segregation Resistance                       |                                | Pass                            |             |
| Filling Ability      | T 347 <sup>[2][5]</sup>  | Slump Flow (in.)                             | 22.0 – 29.0 in. <sup>[6]</sup> | Target -2.0                     | Target +2.0 |
| Thermal              | T 309  | Concrete Temperature (°F)                    |                                | 50                              | 90          |
| Strength             | T 22 <sup>[2][7]</sup>   | Compressive Strength (psi)                   | Form Removal                   | 70% of $f'_c$ <sup>[8][9]</sup> | –           |
|                      |  |  | Storage in Adverse Conditions  | $f'_c$ <sup>[8]</sup>           | –           |
|                      |  |  | 28 Days                        | $f'_c$ <sup>[8]</sup>           | –           |
|                      |  |  | 56 Days                        | $f'_c$ <sup>[8][9]</sup>        | –           |
| Durability           | T 121 <sup>[2]</sup><br>T 152 <sup>[2]</sup><br>T 196 <sup>[2]</sup> | Air Content (%)                              |                                | Target -1.5                     | Target +1.5 |

[1] Batch tickets shall be provided to the Department by the Producer. Producers shall report the source, type, quantity, and design target for each constituent material incorporated into the proposed mix design onto batch tickets meeting AASHTO M 157 Standard Specification for Ready-Mixed Concrete.

[2] Mix design target shall be identified on the Department issued cement concrete mix design sheet.

[3] Required for non-self-consolidating concrete (SCC).

[4] Required for non-self-consolidating concrete (SCC). Testing for segregation resistance shall be performed while the concrete is being discharged and during AASHTO T 119 Standard Method of Test for Slump of Hydraulic Cement Concrete. Visual signs of segregation include coarse particles advancing in front of or behind the fine particles and mortar and a tendency for coarse aggregate to separate from the mortar, particularly when the mixture is being consolidated.

[5] Required for Self-Consolidating Concrete (SCC).

[6] Mix design target and production test results shall meet the specified range.

[7] Three (3) 4 x 8 in. cylinders shall be cast and tested for each set specified for maximum aggregate size less than 1-1/2 inches. Two (2) 6 x 12 in. cylinders shall be cast and tested for each set specified for maximum aggregate size greater than 1 inch.

[8] The specified compressive strength ( $f'_c$ ) is defined as the minimum compressive strength required to be attained at a specified age for a given concrete structure, as specified in construction standard specifications, contract document special provisions, and design plans.

[9] In instances where the 28-Day test results do not meet the specified limits, 56-Day test results shall meet the 28-Day limits.



**g. Quality Control Records, Documentation, and Analysis.**

The Fabricator shall organize, maintain, and retain Quality Control documentation, including the Quality System Manual, Quality Control Plans for contract work items, plant certification records, personnel qualification and certification records, laboratory accreditation and certification records, daily diaries, record books, databases, Department and Contractor correspondence, random sampling location report forms, test report forms, inspection report forms, certificates of compliance, non-conformance report forms, corrective actions, control charts, quality level analysis, Quality Control test result summary sheets, material quantities produced or placed by lot and subplot, and other Quality Control documentation per the Department Approved Quality System Manual, Quality Control Plan, and specified herein.

At a minimum, the Fabricator shall maintain a filing system for the following QC records and documentation:

- (a) Plant Certification
- (b) QC Laboratory NETTCP Qualification or AASHTO Accreditation
- (c) Qualifications and Certifications for QC Manager(s) and QC Technician(s)
- (d) Approved Quality System Manual (QSM)
- (e) Approved Quality Control Plan (if applicable)
- (f) MassDOT Approved Mix Design Sheet(s) and Approval Letter(s)
- (g) MassDOT Standard Shop Drawings
- (h) MassDOT Approved Shop Drawings
- (i) Manufacturer's Technical Data Sheet for each chemical admixture
- (j) Manufacturer's Mill Certification for hydraulic cement, supplementary cementitious materials, and steel reinforcement
- (k) Batch tickets
- (l) QC Inspection Report Forms (IRFs) for each fabricated concrete product
- (m) QC Test Report Forms (TRFs)
- (n) Non-Conformance Reports (NCRs)
- (o) Documentation of Repairs (if applicable)
- (p) Fabricator Certificate of Compliance (Division I, Subsection 6.01) for each fabricated concrete product
- (q) QC and Production equipment calibrations, verifications, and maintenance documentation.

All QC records and documentation shall be made available upon the request of the Department.

**2. Department Acceptance.**

Acceptance shall be performed by the Department, including consultants under direct contract with the Department independent of the Fabricator, to evaluate the degree of compliance with contract requirements, to monitor the Fabricator's Quality Control activities, to determine the corresponding value for a given product and the acceptability of all material produced and placed through Department acceptance sampling, testing, inspection, evaluation, and documentation.

**a. Acceptance of Quality Control Operating Documents.**

The Department will review all Quality Control operating documents, including the Quality System Manual and Quality Control Plans for contract work items submitted by the Fabricator. Department approval shall be subject to conformance with the requirements specified herein.

**b. Monitoring Fabricator Quality Control.**

The Department will monitor the adequacy of the Fabricator Quality Control System, to ensure Fabricator compliance to all items identified in Quality Control documents, including the Fabricator Quality System Manual and Quality Control Plans for contract work items. Failure to comply with these Quality Control documents may result in work suspension.

**c. Acceptance Inspection.**

Acceptance inspection will be performed and reported by qualified Department (or designee) Acceptance Technicians, to visually inspect equipment, environmental conditions, materials, and workmanship, per the requirements specified herein. The results and findings of Acceptance inspection will be documented on the Department’s Inspection Report Forms (IRFs). The Department will conduct immediate initiation of non-conformance reporting for non-conforming inspection results and uncontrolled processes.

**d. Acceptance Sampling and Testing.**

Acceptance sampling and testing will be performed and reported by qualified Department (or designee) Acceptance Technicians, to provide quality characteristic data used for Department Acceptance determination, per the requirements specified herein. The results and findings of Acceptance sampling and testing will be documented on the Department’s Test Report Forms (TRFs). The Department will conduct immediate initiation of non-conformance reporting and corrective action for materials with test results not within allowable limits.

**(1) Concrete Production Sampling and Testing.**

Acceptance sampling and testing will be conducted during production per the minimum requirements specified herein. Production test results shall be within the limits specified herein.

**Table M4.02.14-11: Acceptance Sampling and Testing Frequency During Concrete Production**

| Lot Size  | Sublot Size | Frequency   |
|---|-------------|---|
| Total quantity of concrete (cy) produced in a year, per approved mix design formulation | 50 cy       | One (1) per sublot or fraction thereof, minimum One (1) per day |

**Table M4.02.14-12: Acceptance Sampling and Testing Requirements During Production**

| Property             | Method   | Quality Characteristic                       |                                | Limits                           |             |
|----------------------|--|--|--------------------------------|----------------------------------|-------------|
|                      |  |  |                                | Min.                             | Max.        |
| Uniformity           | M 157 <sup>[1]</sup>   | Batching Quantities of Constituent Materials |                                | Table M4.08.0-1                  |             |
|                      | T 119 <sup>[2][3]</sup>  | Slump (in.)                                  | < 4 in.                        | Target -1.0                      | Target +1.0 |
|                      |  |  | 4 – 8 in.                      | Target -1.5                      | Target +1.5 |
| T 121 <sup>[2]</sup> | Unit Weight (lb/ft <sup>3</sup> )                                    | For Information                              |                                |                                  |             |
| Workability          | T 119 <sup>[4]</sup>   | Segregation Resistance                       |                                | Pass                             |             |
| Filling Ability      | T 347 <sup>[2][5]</sup>  | Slump Flow (in.)                             | 22.0 – 29.0 in. <sup>[6]</sup> | Target -2.0                      | Target +2.0 |
| Thermal              | T 309  | Concrete Temperature (°F)                    |                                | 50                               | 90          |
| Strength             | T 22 <sup>[2][7]</sup>   | Compressive Strength (psi)                   | 7 Days                         | -                                | -           |
|                      |  |  | 28 Days                        | f <sub>c</sub> <sup>[8]</sup>    | -           |
|                      |  |  | 56 Days                        | f <sub>c</sub> <sup>[8][9]</sup> | -           |
| Durability           | T 121 <sup>[2]</sup><br>T 152 <sup>[2]</sup><br>T 196 <sup>[2]</sup> | Air Content (%)                              |                                | Target -1.5                      | Target +1.5 |

[1] Batch tickets shall be provided to the Department by the Cement Concrete Producer. Producers shall report the source, type, quantity, and design target for each constituent material incorporated into the proposed mix design onto batch tickets meeting AASHTO M 157 Standard Specification for Ready-Mixed Concrete.

[2] Mix design target shall be identified on the Department issued cement concrete mix design sheet.

- [3] Required for non-self-consolidating concrete (SCC).
- [4] Required for non-self-consolidating concrete (SCC). Testing for segregation resistance shall be performed while the concrete is being discharged and during AASHTO T 119 Standard Method of Test for Slump of Hydraulic Cement Concrete. Visual signs of segregation include coarse particles advancing in front of or behind the fine particles and mortar and a tendency for coarse aggregate to separate from the mortar, particularly when the mixture is being consolidated.
- [5] Required for Self-Consolidating Concrete (SCC).
- [6] Mix design target and production test results shall meet the specified range.
- [7] Three (3) 4 x 8 in. cylinders shall be cast for each set specified for maximum aggregate size less than 1-1/2 inches. Two (2) 6 x 12 in. cylinders shall be cast for each set specified for maximum aggregate size greater than 1 inch.
- [8] The specified compressive strength ( $f'_c$ ) is defined as the minimum compressive strength required to be attained at a specified age for a given concrete structure, as specified in construction standard specifications, contract document special provisions, and design plans.
- [9] In instances where the 28-Day test results do not meet the specified limits, 56-Day test results shall meet the 28-Day limits.

Subsection M4.02.16: Precast Drainage Structures

Delete this subsection.

Subsection M4.06.1: High Performance Cement Concrete

Replace this subsection with the following;

**M4.06.1: High Performance Concrete**

High Performance (HP) Concrete shall meet the requirements of M4: Cement and Cement Concrete Materials and the requirements specified herein. HP Concrete shall be designed and produced with precise proportions of constituent materials to form a homogenous composition with a well distributed, spaced, and sized air void system and quality concrete properties. HP Concrete shall exhibit acceptable quality characteristics and material properties, including uniformity, workability, bleeding and settlement, setting, thermal effects, shrinkage control, strength, modulus of elasticity, aesthetics, long-term durability, and resistance to premature deterioration due to freezing, thawing, and de-icing cycles, alkali silica reaction, corrosion of steel reinforcement, abrasion, erosion, sulfate reaction, salt crystallization, acid disintegration, carbonation reaction, delayed ettringite formation, and marine environments for the expected service life of the structure.

The Contractor may elect to use fly ash, slag cement, silica fume, or a combination thereof provided that the dosage limits, permeability, and strength provisions contained herein are satisfied and the MassDOT Research and Materials Section (RMS) has approved the trial batches and mix design. Changing the mix design shall not be accepted and approved by RMS without the preparing, testing, and approval of trial batches for the revised mix design. HP Concrete shall meet AASHTO M 157 Standard Specification for Ready-Mixed Concrete.

**Table M4.06.1-1: Classifications of HP Concrete**

| 28 Day Compressive Strength | Nominal Maximum Coarse Aggregate Size (in.) | Maximum Total Cementitious Content (lb per yd <sup>3</sup> ) |
|-----------------------------|---|--|
| 4,000 psi                   | ¾   | 585  |
| 4,000 psi                   | ⅜   | 610  |
| 5,000 psi                   | ¾   | 685  |
| 5,000 psi                   | ⅜   | 710  |
| 6,500 psi                   | ⅜, ½, ¾                                     | -  |
| 8,000 psi                   | ⅜, ½, ¾                                     | -  |

Prior to concrete placement, the Contractor shall develop and forward a copy of the HP Concrete design mix to the Department for review and approval. Approval of the design mix must be obtained prior to placement of concrete. The mix design sent to the Department must be accompanied with trial batch information. Trial batches shall be performed in accordance with procedures outlined by the Department.

Trial batch testing will be performed on samples of the same contents and proportions as the HP Concrete to be used in the proposed structures. AASHTO T 358 Standard Method of Test for Surface Resistivity Indication of Concrete’s Ability to Resist Chloride Ion Penetration or AASHTO TP 119 Standard Method of Test for Electrical Resistivity of a Concrete Cylinder Tested in a Uniaxial Resistance Test shall be conducted and meet the requirements specified in Table M4.06.1-2.

**Table M4.06.1-2: Durability Requirements**

| Property   | Method                      | Quality Characteristic                               |         | Limits        |      |
|------------|-----------------------------|--|---------|---------------|------|
|            |                             |  |         | Min.          | Max. |
| Durability | T 358 <sup>[1][2][3]</sup>  | Surface Chloride Ion Penetration Resistance (kΩ-cm)  | 7 Days  | Informational |      |
|            |                             |  | 28 Days | 21            | -    |
|            | Or                          |  |         |               |      |
|            | TP 119 <sup>[1][2][3]</sup> | Uniaxial Chloride Ion Penetration Resistance (kΩ-cm) | 7 Days  | Informational |      |
| 28 Days    |                             |  | 10.4    | -             |      |

[1] Three 4 x 8 in. cylinders shall be cast for each set specified.

[2] This test method has been known to have compatibility issues with mix designs containing calcium nitrite chemical admixtures or steel fibers. As a result, inclusion of these materials into the test specimens may negatively affect test results. An additional set of cylinders shall be cast and tested without the noted materials. The calcium nitrite shall be replaced by an equivalent quantity of water. A correction factor shall be determined by the following equation:

$$CF = PR_{REMOVED} / PR_{MIX DESIGN}$$

where  $PR_{REMOVED}$  = Penetration Resistivity with noted materials removed,  $PR_{MIX DESIGN}$  = Penetration Resistivity of original mix design with noted materials included, and CF = Correction Factor. The correction factor established during the mix design verification shall be applied to the penetration resistivity test results to compensate for the noted materials. The corrected penetration resistivity ( $PR_{CORRECTED}$ ) shall be determined by the following equation and meet the specified limits identified in the table:

$$PR_{CORRECTED} = PR_{MIX DESIGN} * CF$$

[3] Specimens shall be moist cured in accordance with AASHTO T 22 Standard Method of Test for Compressive Strength of Cylindrical Concrete Specimens and shall be in saturated surface dry (SSD) condition during testing.

**A. Supplementary Cementitious Materials.**

High Performance Concrete shall meet the supplementary cementitious materials (SCM) requirements specified in Section M4 and the content target requirements specified in Table M4.06.1-3. SCMs shall be incorporated into the mix design formulation to successfully mitigate alkali silica reaction (ASR) without exceeding the SCM content requirements. High Performance Concrete shall meet the ASR requirements specified in Section M4.02.00: Cement Concrete. SCM content is defined as the percent by mass replacement of hydraulic cement.

**Table M4.06.1-3: SCM Content Target**

| <b>Supplementary Cementitious Material</b>      | <b>SCM Content</b> |
|---|--------------------|
| Blended Hydraulic Cement Content <sup>[1]</sup> | [2]                |
| Fly Ash (Class F) Content                       | 15 – 30            |
| Slag Content                                    | 20 – 50            |
| Silica Fume Content                             | 7 – 15             |
| Total Fly Ash and Silica Fume Content           | ≤ 35               |
| Total SCM Content                               | ≤ 50               |

<sup>[1]</sup> The SCM content of blended hydraulic cement shall be identified on the Manufacturer's certified mill test report.

<sup>[2]</sup> SCMs in blended hydraulic cement shall meet the total cementitious material requirements for fly ash, slag, and silica fume specified in the table.

#### **B. Water-Cementitious Ratio.**

The water-cementitious ratio shall be 0.40 maximum. The water content of all additives shall be included in the water-cementitious ratio.

#### **C. Air Content.**

Cement concrete shall meet the air content targets specified in Section M4.02.00, Table M4.02.06-1: Air Content Target.

#### **D. Chemical Admixtures.**

Chemical admixtures incorporated into cement concrete shall meet Section M4.02.05: Chemical Admixtures and be precisely dosed per admixture manufacturer recommendations to meet the required properties of HP Concrete.

HP Concrete shall be formulated with 3.0 gal of corrosion inhibiting admixture per yd<sup>3</sup> of concrete in order to increase the active corrosion threshold to 9.9 lb of chloride per yd<sup>3</sup> of concrete at the reinforcing bar level. Acceptance will depend upon the material's conformance, as documented by certified test results, to all applicable sections of AASHTO M 194M/M 194. The calcium nitrite solution shall contain 30 ± 2% calcium nitrite by weight. The calcium nitrite material shall have neutral set characteristics.

#### **E. Paste and Void Content.**

HP Concrete shall be designed with a paste content that decreases the tendency of shrinkage cracking, while also adequately filling the voids of the concrete to provide sufficient separation and effective bonding between the aggregate particles. HP Concrete shall meet Table M4.06.1-4.

**Table M4.06.1-4: Paste and Void Content Target**

| <b>Property</b>   | <b>Design Parameter</b>                     | <b>Target</b>             |
|---|---|---------------------------|
| Shrinkage Resistance  | Paste Content Target (%)                    | $\leq 30^{[1][2]}$        |
| Workability   | Paste Content to Void Content (PC/VC) Ratio | 1.1 – 1.75 <sup>[2]</sup> |
| <p>[1] Not applicable to mix design formulations incorporating sufficiently designed dosages of S-SRA Shrinkage Reducing or Type S-CRA Crack Reducing chemical admixtures meeting Section M4.05.0.</p> <p>[2] Not applicable to specialized mix design formulations, including self-consolidating concrete.</p> |   |                           |

Section M4.06.2: High Early Strength Concrete*Add this new subsection:***M4.06.2: High Early Strength Concrete**

High Early Strength Concrete shall meet the requirements of Section M4: Cement and Cement Concrete Materials and the requirements specified herein. High Early Strength Concrete shall meet the requirements specified in Table M4.06.2-1.

**Table M4.06.2-1: Verification Testing Requirements**

| Property   | Method                           | Quality Characteristic                               |          | Limits                     |                     |
|--|----------------------------------|--|----------|----------------------------|---------------------|
|  |                                  |  |          | Min.                       | Max.                |
| Strength   | AASHTO T 22 <sup>[1]</sup>       | Compressive Strength (psi)                           | 12 Hours | Informational              |                     |
|  |                                  |  | 24 Hours | 2500                       | -                   |
|  |                                  |  | 3 Days   | 4000                       | -                   |
|  |                                  |  | 7 Days   | 5000                       | -                   |
|  |                                  |  | 28 Days  | Informational              |                     |
|  | AASHTO T 97 <sup>[2]</sup>       | Flexural Strength (psi)                              | 12 Hours | Informational              |                     |
|  |                                  |  | 24 Hours | 400                        | -                   |
|  |                                  |  | 3 Days   | 550                        | -                   |
|  |                                  |  | 7 Days   | 650                        | -                   |
|  |                                  |  | 28 Days  | Informational              |                     |
|  | ASTM C882 <sup>[3]</sup>         | Slant Sheared Bond Strength (psi)                    | 24 Hours | 1200                       | -                   |
|  |                                  |  | 7 Days   | 1900                       | -                   |
|  |                                  |  | 28 Days  | 2200                       | -                   |
| Setting  | AASHTO T 197                     | Initial Set (min.)                                   |          | Informational              |                     |
|  |                                  | Final Set (min.)                                     |          | Informational              |                     |
| Shrinkage<br>Cracking<br>Resistance <sup>[5]</sup> | AASHTO T 160 <sup>[4]</sup>      | Unrestrained Volume Change (µε)                      | 28 Days  | -                          | 420                 |
|  | ASTM C1581 <sup>[6]</sup>        | Restrained Shrinkage                                 | 28 Days  | No Cracking <sup>[7]</sup> |                     |
|  | Or                               |  |          |                            |                     |
|  | AASHTO T 363 <sup>[8]</sup>      | Restrained Shrinkage (psi)                           | 7 Days   | -                          | 0.6T <sup>[9]</sup> |
| Durability   | AASHTO T 358 <sup>[1][10]</sup>  | Surface Chloride Ion Penetration Resistance (kΩ-cm)  | 7 Days   | Informational              |                     |
|  |                                  |  | 28 Days  | 21                         | -                   |
|  | Or                               |  |          |                            |                     |
|  | AASHTO TP 119 <sup>[1][10]</sup> | Uniaxial Chloride Ion Penetration Resistance (kΩ-cm) | 7 Days   | Informational              |                     |
|  |                                  |  | 28 Days  | 10.4                       | -                   |

[1] Three (3) 4 x 8 in. cylinders shall be cast and tested for each age specified for maximum aggregate size less than 1-1/2 inches. Two (2) 6 x 12 in. cylinders shall be cast and tested for each age specified for maximum aggregate size greater than 1 inch.

[2] For applications where the concrete is subject to flexural stresses: Two (2) 6 x 6 x 20 in. beams shall be cast for each age specified.

[3] For applications where bond strength is desired.

[4] For applications where the concrete is not subject to restraining stresses.

[5] Not applicable to mix design formulations incorporating sufficiently designed dosages of Type S-SRA Shrinkage Reducing or Type S-CRA Crack Reducing chemical admixtures meeting Section M4.02.05.

[6] For nominal maximum aggregate sizes less than or equal to 1/2 in and for applications where the concrete is subject to restraining stresses.

[7] Cracking is defined as the sudden decrease in compressive strain greater than 30  $\mu\epsilon$ .

[8] For any nominal maximum aggregate size and for applications where the concrete is subject to restraining stresses. The circumferential residual stress in the specimen at the inner face of the specimen ( $\sigma\theta$ (RIC)) shall be calculated according to AASHTO T 363.

[9] The splitting tensile strength (T) at 28 days shall be determined by AASHTO T 198 Standard Method of Test for Splitting Tensile Strength of Cylindrical Concrete Specimens.

[10] Specimens shall be moist cured in accordance with AASHTO T 22 Standard Method of Test for Compressive Strength of Cylindrical Concrete Specimens and shall be in saturated surface dry (SSD) condition during testing.

**Section M4.06.3: Rapid Hardening Concrete**

*Add this new subsection:*

**M4.06.3: Rapid Hardening Concrete**

Rapid Hardening Concrete shall meet the requirements of M4: Cement and Cement Concrete Materials and the requirements specified herein. Rapid Hardening Concrete shall meet the requirements specified in Table M4.06.3-1.

**Table M4.06.3-1: Verification Testing Requirements**

| Property                      | Method                      | Quality Characteristic                       |          | Limits                     |      |
|-------------------------------|-----------------------------|--|----------|----------------------------|------|
|                               |                             |  |          | Min.                       | Max. |
| Strength                      | AASHTO T 22 <sup>[1]</sup>  | Compressive Strength (psi)                   | 2 Hours  | Informational              |      |
|                               |                             |  | 4 Hours  | 2500                       | -    |
|                               |                             |  | 6 Hours  | Informational              |      |
|                               |                             |  | 24 Hours | 4000                       | -    |
|                               |                             |  | 7 Days   | 5000                       | -    |
|                               |                             |  | 28 Days  | Informational              |      |
|                               | AASHTO T 97 <sup>[2]</sup>  | Flexural Strength (psi)                      | 2 Hours  | Informational              |      |
|                               |                             |  | 4 Hours  | 400                        | -    |
|                               |                             |  | 6 Hours  | Informational              |      |
|                               |                             |  | 24 Hours | 550                        | -    |
|                               |                             |  | 7 Days   | 650                        | -    |
|                               |                             |  | 28 Days  | Informational              |      |
|                               | ASTM C882 <sup>[3]</sup>    | Slant Sheared Bond Strength (psi)            | 24 Hours | 1200                       | -    |
|                               |                             |  | 7 Days   | 1900                       | -    |
|                               |                             |  | 28 Days  | 2200                       | -    |
| Setting                       | AASHTO T 197                | Initial Set (min.)                           |          | Informational              |      |
|                               |                             | Final Set (min.)                             |          | Informational              |      |
| Shrinkage Cracking Resistance | AASHTO T 160 <sup>[4]</sup> | Unrestrained Volume Change ( $\mu\epsilon$ ) | 28 Days  | -                          | 420  |
|                               | ASTM C1581 <sup>[5]</sup>   | Restrained Shrinkage                         | 28 Days  | No Cracking <sup>[6]</sup> |      |
|                               | Or                          |  |          |                            |      |



|            |                                 |  |         |               |                     |
|------------|---------------------------------|--|---------|---------------|---------------------|
|            | AASHTO T 363 <sup>[7]</sup>     | Restrained Shrinkage (psi)                           | 7 Days  | -             | 0.6T <sup>[8]</sup> |
| Durability | AASHTO T 358 <sup>[1][9]</sup>  | Surface Chloride Ion Penetration Resistance (kΩ-cm)  | 7 Days  | Informational |                     |
|            |                                 |  | 28 Days | 21            | -                   |
|            | Or                              |  |         |               |                     |
|            | AASHTO TP 119 <sup>[1][9]</sup> | Uniaxial Chloride Ion Penetration Resistance (kΩ-cm) | 7 Days  | Informational |                     |
| 28 Days    |                                 |  | 10.4    | -             |                     |

- [1] Three (3) 4 x 8 in. cylinders shall be cast and tested for each age specified for maximum aggregate size less than 1-1/2 inches. Two (2) 6 x 12 in. cylinders shall be cast and tested for each age specified for maximum aggregate size greater than 1 inch.
- [2] For applications where the concrete is subject to flexural stresses: Two (2) 6 x 6 x 20 in. beams shall be cast for each age specified.
- [3] For applications where bond strength is desired.
- [4] For applications where the concrete is not subject to restraining stresses.
- [5] For nominal maximum aggregate sizes less than or equal to 1/2 in and for applications where the concrete is subject to restraining stresses.
- [6] Cracking is defined as the sudden decrease in compressive strain greater than 30 µε.
- [7] For any nominal maximum aggregate size and for applications where the concrete is subject to restraining stresses. The circumferential residual stress in the specimen at the inner face of the specimen (σ<sub>θ</sub>(RIC)) shall be calculated according to AASHTO T 363.
- [8] The splitting tensile strength (T) at 28 days shall be determined by AASHTO T 198 Standard Method of Test for Splitting Tensile Strength of Cylindrical Concrete Specimens.
- [9] Specimens shall be moist cured in accordance with AASHTO T 22 Standard Method of Test for Compressive Strength of Cylindrical Concrete Specimens and shall be in saturated surface dry (SSD) condition during testing.

**Section M4.06.2: Lightweight High Early Strength Concrete**

Add this new subsection:

**M4.06.4: Lightweight Concrete**

Lightweight Concrete shall meet the requirements of Section M4: Cement and Cement Concrete Materials and the requirements specified herein. Lightweight Concrete shall be formulated with lightweight aggregate meeting Section M4.02.03: Lightweight Aggregates. Lightweight Concrete shall meet the requirements specified in Table M4.06.4-1.

**Table M4.06.4-1: Verification Testing Requirements**

| Property    | Method    | Quality Characteristic  | Limits |       |
|-------------|-----------|---|--------|-------|
|             |           |   | Min.   | Max.  |
| Unit Weight | ASTM C567 | Calculated Equilibrium Density, E <sub>c</sub> (lb/ft <sup>3</sup> ) <sup>[1]</sup> | -      | 115.0 |

[1] Measured Oven Dry Density (O<sub>m</sub>) shall be used for Calculated Equilibrium Density (E<sub>c</sub>).

## SECTION M7: PAINTS, PROTECTIVE COATINGS AND PAVEMENT MARKINGS

### Section M7.00.0: General Requirements for Paints and Protective Coatings

*Replace this subsection with the following:*

All paint shall conform to the following general requirements.

#### **1. Materials.**

The raw materials used in the following specifications for paints and protective coatings shall conform to the ASTM or AASHTO specifications.

#### **2. Proportions.**

Paint proportions and percentages given in the following specification are expressed by weight.

#### **3. Condition in the container.**

Paint and protective coatings shall be homogeneous, free of contaminant and of a consistency suitable for use in the capacity for which it is specified. The finished product shall be well ground and the pigment shall be properly dispersed and suspended in the vehicle according to the requirements of the paint or protective coating. The dispersion shall be of such nature that the pigment does not settle badly, does not cake or thicken in the container, and does not become granular, jelled or curdled. Any settlement of pigment in the paint or protective coating shall be a thoroughly wetted soft mushy mass permitting the complete and easy vertical penetration of a paddle. Settled pigment shall be easily dispersed, with a minimum resistance to the sidewise manual motion of the paddle across the bottom of the container, to form a smooth uniform product of the proper consistency.

#### **4. Packaging.**

The finished paint or protective coating shall be furnished in new 5-gal, round, non-tapered containers. The containers shall meet U.S. Department of Transportation Hazardous Materials Shipping Regulations.

The following information shall be labeled on each container in a clear legible manner:

- a) Name of Manufacturer
- b) Place of Manufacture
- c) Manufacturer's Batch Number
- d) MassDOT Specification Number
- e) Date of Manufacture

Precautions concerning the handling and the application of the paint or protective coating shall be shown on the label.

#### **5. Testing.**

Testing of paints will be done by the Department in accordance with the methods of Federal Test Method Standard Number 141, AASHTO and ASTM methods described below.

In addition, the Department reserves the right to make use of any information or methods of testing to determine the quality of paint and paint materials.

### M7.01.3: Liquid Thermoplastic Striping Material

*In the first paragraph of B. Sampling and Testing, 2. Testing replace AASHTO M 249 with AASHTO T 250.*

### M7.01.07: Glass Beads

*Replace this subsection with the following:*

This specification covers the requirements for glass beads which are to be dropped or sprayed on pavement markings. Glass bead suppliers and approved batch numbers are listed on the QCML.

All glass beads shall meet the requirements of AASHTO M 247, and be tested in accordance with AASHTO T 346 and the following:

1. A minimum of 80% of the glass beads shall be true spheres when tested in accordance with ASTM D1155, Procedure A.
2. The glass beads shall be manufactured from commercial grade soda lime glass cullet and shall meet the AASHTO concentration for heavy metals, 200 ppm maximum, as tested in accordance with EPA test methods 3052, 6010B and 6010c, or AASHTO T 392. The silica content shall be 60% minimum (ASTM C169).
3. Moisture Resistance - The Type 1 and Type 4 glass beads shall be treated with a moisture proof coating and be moisture resistant as tested by AASHTO T 346, Referee Method.
4. Adherence - The Type 4 glass beads shall be coated with a silane-type adherence coating to enhance embedding in, and adherence to, the applied binder film. The coated beads shall emit a yellow-green fluorescence when tested by the Dansyl Chloride test procedure.
5. Intermix glass beads used in the manufacture of thermoplastic pavement markings shall meet the requirements of AASHTO M 247, Type 1 glass beads. A moisture proof coating is optional.

#### **A. Gradation.**

The glass beads shall be tested in accordance with ASTM D1214 (By use of U.S. Standard Sieves).

Standard gradation beads shall meet the requirements of AASHTO M 247, Type 1.

Large gradation beads shall meet the requirements of AASHTO M 247, Type 4.

#### **B. Packaging.**

The beads shall be packaged in 50-lb or greater polyethylene-lined burlap paper bags or equal container; such containers guaranteed to furnish dry and undamaged beads. The following information shall be indelibly labeled in a clear and legible manner on each container:

- (a) The name of the manufacturer.
- (b) The place of manufacture.
- (c) The words: "Glass Beads-Traffic".
- (d) Size/Type/Coating.
- (e) Materials Specification Number.
- (f) The date of shipment (month and year).
- (g) The batch number.
- (h) Net weight.

#### **C. Approval Procedure.**

Requests for approval shall be submitted to the Department accompanied by:

- a. Certificate of Compliance stating that the material complies with AASHTO M 247, and tested in accordance with AASHTO T 346 and all applicable MassDOT requirements;
- b. Independent lab test results; and
- c. One bag of glass beads per batch in sample bags meeting the specifications above for verification testing.

#### M7.02.: Structural Paint

*Replace this subsection with the following:*

##### **1. General**

New coatings systems shall be a low VOC that meets current VOC regulations. Coating systems shall be selected from the MassDOT QCML-NEPCOAT Qualified Products List "B". Structural paint will be tested according to the following:

- ASTM D 562 Consistency,
- ASTM D 1475 Density,
- ASTM D3723 Pigment
- ASTM D 2369 Volatile Content
- AMS STD 595 Federal color Index



## DOCUMENT 00718

SPECIAL PROVISION FOR PARTICIPATION BY MINORITY OR WOMEN'S BUSINESS ENTERPRISES  
AND SERVICE- DISABLED VETERAN- OWNED BUSINESS ENTERPRISES

(Implementing Chapter 102, Section 24 and  
Chapter 273, Section 124, of the Acts of 1994 and Chapter 56, Sections 1 to 5 of the Acts of 2010  
and subsequent Acts)

Revised: September 27, 2021

## I. PARTICIPATION

## M/WBE PARTICIPATION GOAL

On this Contract, the Massachusetts Department of Transportation (MassDOT) has established a goal for participation by Minority or Women Business Enterprise(s) (M/WBE). One half of the goal shall be met in the form of contractor activity. This goal shall remain in effect throughout the life of the Contract.

Design-Bid-Build Projects: M/WBE Participation Goal 12 %  
*(One half of this goal shall be met in the form of Subcontractor construction activity)*

Design-Build Projects: M/WBE Design Participation Goal \_\_\_% and M/WBE  
Construction Participation Goal \_\_\_%  
*(One half of the Construction Goal shall be met in the form of Subcontractor  
construction activity)*

## SDVOBE PARTICIPATION BENCHMARK

On this Contract, the Massachusetts Department of Transportation (MassDOT) has established a goal for participation by Service- Disabled Veteran- Owned Business Enterprise(s) (SDVOBE). This goal shall remain in effect throughout the life of the Contract.

Design-Bid-Build Projects: SDVOBE Participation Goal \_\_\_%

Design-Build Projects: SDVOBE Design Participation Goal \_\_\_% and SDVOBE  
Construction Participation Goal \_\_\_%

## II. POLICY

It is the policy of the MassDOT that Minority, Women Business Enterprises (M/WBEs) and Service- Disabled Veteran- Owned Business Enterprises (SDVOBEs) have equal opportunity to receive and participate in the performance of its state funded Contracts.

## III. M/WBE and SDVOBE OBLIGATION

The Contractor agrees to take all necessary and reasonable steps to ensure that MBE, WBE, and SDVOBEs have the maximum opportunity to compete for, and to perform, Department Contracts.

## IV. FAILURE TO COMPLY WITH M/WBE OR SDVOBE REQUIREMENTS

All Contractors and Subcontractors are hereby advised that failure to carry out the requirements of these Provisions constitutes a breach of Contract which may result in termination of the Contract, a determination that the Contractor or Subcontractor be barred from bidding on Department Contracts for up to three (3) years, or any other remedy as the Department may impose under Section XIV of these Special Provisions.

## V. REQUIRED SUBCONTRACT PROVISIONS

The Prime Contractor shall include the Provisions of Sections II, III, and IV above in every subcontract making those provisions binding on each subcontractor, supplier, manufacturer, consultant or service provider.

## VI. DEFINITIONS

For the purpose of these Special Provisions, the terms listed below are defined as follows:

Minority Business Enterprise or MBE means any individual, business organization, or non-profit corporation certified as a MBE by the Supplier Diversity Office (SDO), formerly known as the State Office of Minority and Women Business Assistance (SOMWBA), or by the Department for the purposes of a particular bid or proposal to be submitted to the Department.

Women Business Enterprise or WBE means any individual, business or organization, or non-profit corporation certified as a WBE by SDO, or by the Department for the purposes of a particular bid or proposal to be submitted to the Department.

Service- Disabled Veterans- Owned Businesses or SDVOBE means a business not less than 51 percent of which is owned by one or more service- disabled veterans or, in the case of any publicly owned business, not less than 51 percent of the stock of which is owned by one or more service-disabled veterans; and the management and daily business operations of which are controlled by one or more service- disabled veterans or, in the case of a veteran with permanent and severe disability, the spouse or permanent caregiver of such veteran.

"Contractor activity" means any work, including but not limited to, construction, demolition, renovation, survey, test boring services, or maintenance work performed under the Contract.

"Approved Joint Venture" means a joint venture between M/WBEs and non-M/WBEs, or SDVOBEs and non-SDVOBEs, which has been established for the purpose of participation on a particular contract, where:

1. The M/WBE or SDVOBE partner(s) shares in the ownership, control, management responsibilities, risks and profits of the joint venture; and
2. The Joint Venture has been approved by the Department for M/WBE or SDVOBE participation on the particular contract.

"Equipment Rental Firm" means a firm that owns equipment and assumes actual and contractual responsibility to rent said equipment to perform a useful function of the work of the contract consistent with normal industry practice.

"Material Supplier" means a vendor engaged in sales to the highway construction industry from an established place of business or source of supply, which:

- (a) Manufactures goods from raw materials or substantially alters them before resale, or
- (b) Provides and maintains a storage facility for materials used in the work, consistent with normal industry practice.

"Department" means the Massachusetts Department of Transportation (MassDOT).

"SDO" means the Massachusetts Supplier Diversity Office.

---

## VII. ELIGIBILITY of M/WBEs

Only firms, *OTHER THAN THE PRIME CONTRACTOR*, which have been certified by SDO and/or the Department as eligible to participate on state funded contracts as MBEs or WBEs may be used on this contract for credit toward the toward the M/WBE participation goal.

1. SDO Directory of Certified M/WBEs: The Supplier Diversity Office publishes a Directory of certified MBE and WBEs. This Directory can be obtained from SDO at <https://www.sdo.osd.state.ma.us/>. This site lists those firms which have been certified as minority owned (MBEs) or women owned (WBEs) in accordance with the criteria of 425 CMR 2.00 et seq to participate as M/WBEs on state funded contracts. It also lists the kinds of work in which each firm engages but does not constitute an endorsement of the quality or performance of any business and does not represent Department subcontractor approval.
2. Application for Certification by the Department for a Particular Project: A firm which has (1) submitted a fully completed M/WBE application to SDO at least 30 days previously, (2) has provided in a timely manner, any additional information which may have been requested by SDO, and (3) can provide evidence, satisfactory to the Department, of a bidder's conditional commitment to subcontract with the firm, if certified, may apply directly to the MassDOT Office of Civil Rights to be certified for participation on the particular contract.
3. Joint Venture Approval: To obtain recognition as an approved joint venture between M/WBEs and non-M/WBEs, the Joint Venture must provide to the MassDOT Office of Civil Rights, at least 14 business days before the bid opening date, the Joint Venture Affidavit Document B00847, and a copy of the Joint Venture Agreement, which shall include a detailed breakdown of the following:
  - (a) Capital participation by the M/WBE,
  - (b) Specific equipment to be provided to the Joint Venture by the M/WBE,
  - (c) Specific responsibilities of the M/WBE in the management of the Joint Venture,
  - (d) Workforce and specific skills to be provided to the Joint Venture by the M/WBE, and
  - (e) Percentage distribution to the M/WBE of the projected profit or loss incurred by the Joint Venture.
  - (f) The Joint Venture shall provide all such additional information as may be requested by the Department for the purpose of determining joint venture eligibility.

## VIII. ELIGIBILITY of SDVOBEs

Only firms, *OTHER THAN THE PRIME CONTRACTOR*, which have demonstrated that they are listed as a service-disabled veteran- owned small businesses within the VetBiz database may be used on this contract for credit toward the SDVOBE participation goal.

1. VetBiz Database: The website, located at [www.VetBiz.gov](http://www.VetBiz.gov), listing verified service- disabled veteran- owned businesses.
2. Joint Venture Approval: To obtain recognition as an approved joint venture between SDVOBEs and non-SDVOBEs, the joint venture must provide to the MassDOT Office of Civil Rights, at least 14 business days before the bid opening date, an application for joint venture participation approval, and a copy of the Joint Venture Agreement, which shall include a detailed breakdown of the following:
  - (a) Capital participation by the SDVOBE,
  - (b) Specific equipment to be provided to the joint venture by the SDVOBE,
  - (c) Specific responsibilities of the SDVOBE in the management of the Joint Venture,
  - (d) Workforce and specific skills to be provided to the joint venture by the SDVOBE, and

- (e) Percentage distribution to the SDVOBE of the projected profit or loss incurred by the Joint Venture.
- (f) The Joint Venture shall provide all such additional information as may be requested by the Department for the purpose of determining joint venture eligibility.

#### IX. COUNTING M/WBE PARTICIPATION AND SDVOBE BENCHMARKS TOWARDS M/WBE AND SDVOBE GOALS

In order for M/WBE participation and SDVOBE benchmarks to count toward the Contract goal, the M/WBE and SDVOBE must have independently managed, supervised and performed the Contract work with its own workforce, equipment and resources. M/WBE and SDVOBE participation which fulfills these requirements shall be counted toward meeting the M/WBE and SDVOBE goals in accordance with the following rules:

1. If a firm has been determined to be an eligible MBE, WBE or SDVOBE, the total dollar value of the contract performed by the M/WBE or SDVOBE is counted toward the applicable goal as follows:
  - a. Except as provided below, in Section IX (1)(g), work performed by a M/WBE or a SDVOBE Prime Contractor shall not be counted toward the M/WBE or SDVOBE goal, and all Prime Contractors, including M/WBE or SDVOBE Prime Contractors, must comply with the M/WBE and SDVOBE requirements of this Contract.
  - b. For a M/WBE or SDVOBE material supplier, sixty percent (60%) of the amount to be paid for materials and supplies required under this Contract shall be credited toward the goal.
  - c. For a M/WBE or SDVOBE who provides a bonafide service such as professional, technical, consultant or managerial services and assistance in the procurement of essential personnel, facilities, equipment, materials, or supplies required for performance of the contract, reasonable fees or commissions charged for the service shall be listed, but the cost of items themselves shall not be credited.
  - d. For a M/WBE or SDVOBE hauler, trucker, or delivery service, which is not also the manufacturer of or a regular dealer in the materials and supplies, reasonable fees charged for delivery of materials and supplies required on the job site shall be credited; the cost of the materials and supplies themselves shall not be credited.
  - e. For a M/WBE or SDVOBE who provides any bonds or insurance specifically required for the performance of the contract, reasonable fees or commissions charged for such service shall be listed, but the face amount or actual premium paid for the bond or insurance shall not be credited.
  - f. The Department shall determine if the fees or commissions listed in accordance with paragraphs (c), (d), and (e) are not excessive as compared with fees or commissions customarily allowed for similar services.
  - g. That portion of the contract total dollar value equal to the percentage of ownership and control of the M/WBE partner(s) or SDVOBE partner(s) in an approved Joint Venture shall be counted toward the Contract goal, except that credit for M/WBE and SDVOBE participation in an approved Prime Joint Venture shall not exceed one half of the Contract goal.

#### X. JOINT CHECK POLICY

1. MassDOT recognizes that the use of joint checks may be a business practice required by material suppliers and vendors in the construction industry. A joint check is a two-party check issued by a/the Prime Contractor to a M/WBE or SDVOBE third party such as a regular dealer of material or supplies. The Prime Contractor issues the check as payor to the M/WBE or SDVOBE and the third party jointly as payees to guarantee payment to the third party for materials or supplies obtained or to be used by the M/WBE or SDVOBE. MassDOT has established criteria to ensure that M/WBEs or SDVOBEs are in fact performing a commercially useful function ("CUF") while using a joint check arrangement. Contractors and M/WBEs or SDVOBEs must meet and conform to these conditions and criteria governing the use of joint checks.



2. In the event that a Contractor, M/WBE or SDVOBE Subcontractor desires to use a joint check, MassDOT will require prior notice and will closely monitor the arrangement for compliance. MassDOT may allow a joint check arrangement and give credit to a Contractor for use of the M/WBE or SDVOBE where one or more of the following conditions exist:
  - The use of a joint check is in fact required by this type of vendor or supplier as a standard industry practice that applies to all Contractors (M/WBEs, SDVOBE and non-M/WBEs or non-SDVOBEs); or is required by a specific vendor or supplier;
  - Payment for supplies or materials would be delayed for an unreasonably extended period without the joint check arrangement;
  - The M/WBE or SDVOBE (or any of its Subcontractors) has a pattern or history of not paying a vendor or supplier within a reasonable time or has not established enough of a credit history with the supplier or vendor; and/or
  - The presence of severe adverse economic conditions, where credit resources may be limited and such practices may be necessary or required to effect timely payments.
3. Other factors MassDOT may consider:
  - Whether there is a requirement by the Prime Contractor that a M/WBE or SDVOBE should use a specific vendor or supplier to meet their Subcontractor specifications;
  - Whether there is a requirement that a M/WBE or SDVOBE use the Prime Contractor's negotiated price;
  - The independence of the M/WBE or SDVOBE;
  - Whether approval has been sought prior to use of a joint check arrangement; and
  - Whether any approved joint check arrangement has exceeded a reasonable period of use;
  - The operation of the joint check arrangement; and
  - Whether the M/WBE or SDVOBE has made an effort to establish alternate arrangements for following periods ( i.e., the M/WBE or SDVOBE must show it can, or has, or why it has not, established or increased a credit line with the vendor or supplier).

Even with the use of a Joint Check, both the Contractor and M/WBE or SDVOBE remain responsible for compliance with all other elements of the Special Provisions, and must still be able to prove that a commercially useful function is being performed for the Contractor.

#### XI. JOINT CHECK PROCEDURES

- The M/WBE or SDVOBE advises its General or Prime Contractor that it will have to use a Joint Check and provide proof of such requirement.
- The General or the Prime Contractor submits a request for approval to MassDOT, using MassDOT's approved Joint Check Request form (Document B00846) and by notification on the M/WBE Letter of Intent (Document B00843) or SDVOBE Letter of Intent (Document B00845), and any other relevant documents. Requests that are not initiated during the bid process should be made in writing and comply with the procedure.
- The Contractor and M/WBE or SDVOBE must have:
  - (a) a written agreement with the material supplier/vendor;
  - (b) applied for credit with the subject material supplier and has supplied the vendor's response;

- (c) shown that it will place all orders to the subject material supplier/vendor;
  - (d) made and retains all decision-making responsibilities concerning the materials; and
  - (e) provided a Joint Check Agreement that is acceptable to MassDOT;
- The MassDOT Office of Civil Rights will review the request and render a decision as part of the approval process for M/WBE or SDVOBE Schedules and Letters of Intent.
  - Review and Approval will be project specific and relevant documents will be made part of the Project Contract file.
  - Payments should be made in the name of both the M/WBE or SDVOBE and vendor or supplier. Payments should be issued and signed by the Contractor as only the guarantor for prompt payment of purchases to the vendor or supplier. The payment to the vendor or supplier should be handled by the M/WBE or SDVOBE (i.e. if possible, funds or the joint check should be processed by the M/WBE or SDVOBE and sent by the M/WBE or SDVOBE to the vendor or supplier).
  - MassDOT may request copies of cancelled checks (front and back) and transmittal information to verify any payments made to the M/WBE or SDVOBE and vendor or supplier.
  - MassDOT may request other information and documents, and may ask questions of the Contractor, Subcontractor and vendor or supplier prior to, during, and after the project performance to ascertain whether the Subcontractor is performing a commercially useful function and all parties are complying with M/WBE or SDVOBE Program policies and procedures as part of the Subcontractor approval process.

## XII. AWARD DOCUMENTATION AND PROCEDURES

1. The two lowest bidders/the two bidders with the lowest price per quality score point, including any M/WBE bidder or SDVOBE bidder, shall submit, by the close of business on the third business day after the bid opening, a completed Schedule of M/WBE and SDVOBE participation, in the form attached, which shall list:
  - a. The full company name, address and telephone number of each M/WBE or SDVOBE with whom the bidder intends to make a commitment;
  - b. The Contract item(s), by number(s) and quantity(ies), if applicable, or specific description of other business activity to be performed by each M/WBE or SDVOBE as set forth in the Letters of Intent. The bidder shall list only firms which have the capacity to perform, manage and supervise the work proposed in accordance with the requirements of Section XII of these Special Provisions.
  - c. The total dollar amount to be paid to each M/WBE or SDVOBE. (Bidders are cautioned that at least one half of the participation goal must be met with Contract work.)
  - d. The total dollar amount to be paid to each M/WBE or SDVOBE which is eligible for credit toward the M/WBE or SDVOBE goal under the crediting rules set out in Section IX.
  - e. The total creditable M/WBE or SDVOBE participation as a percentage of the total bid price.
2. All firms listed on the Schedule must be currently certified.
3. The two lowest bidders/the two bidders with the lowest price per quality score point shall submit with their Schedules of Participation, fully completed, signed Letters of Intent from each of the M/WBEs or SDVOBEs listed on the Schedule. The Letters of Intent shall be in the form attached and shall identify specifically the contract activity the M/WBE or SDVOBE proposes to perform, expressed as contract item number, if applicable, description of the activity, quantity, unit price and total price. In the event of discrepancy between the Schedule and the Letter of Intent, the Letter of Intent shall govern.

4. Evidence of good faith efforts will be evaluated by the Department in the selection of the lowest responsible bidder/best value bidder. All information requested by the Department for the purpose of evaluating the bidder's efforts to achieve the goal must be provided within three calendar days and must be accurate and complete in every detail. The apparent low bidder's/best value bidder's attainment of the M/WBE or SDVOBE goal or a satisfactory demonstration of good faith efforts is a prerequisite for Award of the Contract.
5. Failure to meet, or to demonstrate good faith efforts to meet, the requirements of these Special Provisions shall render a bid non-responsive. Therefore, in order to be eligible for award, the bidder (1) must list on the Schedule of Participation, and provide the required Letters of Intent for, M/WBE or SDVOBE participation which meets or exceeds the Contract goal in accordance with the terms of these Special Provisions or (2) must demonstrate, to the satisfaction of the Department, that good faith efforts were made to achieve the goal.
6. If the Department finds that the percentage of M/WBE or SDVOBE participation submitted by the bidder on its Schedule does not meet the Contract goal, or that the Letters of Intent were not timely filed, and that the bidder has not demonstrated good faith efforts to comply with these requirements, it shall propose that the bidder be declared ineligible for Award. In that case, the bidder may request administrative reconsideration. Such requests must be sent in writing within three calendar days of receiving notice of proposed ineligibility to: The Office of the General Counsel, Massachusetts Department of Transportation, 10 Park Plaza, Boston, MA, 02116.
7. If, after administrative reconsideration, the Department finds that the bidder has not shown that sufficient good faith efforts were made to comply with the requirements of these Special Provisions it shall reject the bidder's proposal and may retain the proposal guaranty.
8. Actions which constitute evidence of good faith efforts to meet the M/WBE or SDVOBE goals include, but are not limited to, all of the following examples:
  - a. Efforts made to select portions of the work proposed to be performed by M/WBEs or SDVOBEs in order to increase the likelihood of achieving the stated goal, including, where appropriate, but not limited to, breaking down contracts into economically feasible units to facilitate M/WBE and SDVOBE participation. The value of such work is required to at least equal the M/WBE and SDVOBE goal.
  - b. Reasonable written notification prior to the opening of bids soliciting individual M/WBEs or SDVOBEs interested in participation in the contract as subcontractors, regular dealers, manufacturers, consultants, or service providers and identifying the specific items or type of work being solicited.
  - c. Written notification to M/WBE or SDVOBE economic development assistance agencies and organizations which provide assistance in recruitment and placement of M/WBEs and SDVOBEs, describing the type of work, supplies or services being considered for M/WBE or SDVOBE subcontracting on this contract.
  - d. Efforts made to negotiate with M/WBEs or SDVOBEs for specific items of work including evidence of:
    - (1) The names, addresses, telephone numbers of M/WBEs or SDVOBEs who were contacted, the dates of initial contact and whether initial solicitations of interest were followed up by contacts with M/WBEs or SDVOBEs to determine with certainty whether the M/WBEs or SDVOBEs were interested. Personal or phone contacts are expected.
    - (2) A description of the information provided by the M/WBEs or SDVOBEs regarding the plans and specifications and estimated quantities for portions of the work to be performed.
    - (3) A statement of why additional agreements with M/WBEs or SDVOBEs were not reached.
    - (4) Documentation of each M/WBE or SDVOBE contacted but rejected and the reasons for the rejection.
  - e. Absence of any agreements between the Contractor and the M/WBE or SDVOBE in which M/WBE or SDVOBE promises not to provide subcontracting quotations to other bidders.
  - f. Efforts made to assist the M/WBEs or SDVOBEs that need assistance in obtaining bonding, insurance, or lines of credit required by the Contractor.

- g. Documentation that qualified M/WBEs or SDVOBEs are not available, or are not interested.
  - h. Attendance at any meeting scheduled by the Department to encourage better Contractor-M/WBE or Contractor- SDVOBE relationships and/or to inform M/WBEs or SDVOBEs of forthcoming M/WBE or SDVOBE utilization opportunities.
  - i. Advertisement, in general circulation media, in trade association publications and in disadvantaged business enterprise-focused media, of interest in utilizing M/WBEs or SDVOBEs and the area of interest.
  - j. Efforts to effectively use the services of available minority community organizations; women organizations, veteran organizations, minority, women disadvantaged and veteran contractor's groups; local, state and federal disadvantaged business assistance offices; and other organizations that provide assistance in recruitment and placement of M/WBEs or SDVOBEs.
9. The demonstration of good faith efforts must establish that the Contractor has actively and aggressively sought out M/WBEs or SDVOBEs to participate in the project and has taken all actions which could be reasonably expected to achieve the goal. Examples of circumstances or actions not acceptable as reasons for failure to meet the M/WBE or SDVOBE goal, include, but are not limited to:
- a. The M/WBE or SDVOBE was unable to provide performance and/or payment bonds.
  - b. The M/WBEs or SDVOBEs commercially reasonable bid was rejected based on price.
  - c. The M/WBE or SDVOBE would not agree to perform items of work at the unit bid price.
  - d. The Contractor does not want to subcontract a percentage of the work sufficient to meet the goal.
  - e. Solicitation by mail or fax only.

### XIII. COMPLIANCE

1. All activity performed by a M/WBE or SDVOBE for credit toward the Contract goal must be performed, managed and supervised by the M/WBE or SDVOBE. Prime Contractor shall not enter into, or condone, any other arrangement.
2. The Prime Contractor shall not perform with its own organization, or assign to any other business, any activity designated for the M/WBEs or SDVOBEs named on the Schedule submitted by the Prime Contractor under Section IX, or under Section XII(6), without the approval of the Department in accordance with the requirements of Sections XIII(6) and XIII(10).
3. The Department may suspend payment for any activity which was not performed by the M/WBE or SDVOBE to whom the activity was committed on the approved Schedule of Participation, or which was not performed in accordance with the requirements of Section XIII(1).
4. The Department retains the right to approve or disapprove all subcontractors. Requests by the Prime Contractor for approval of participation by a M/WBE or SDVOBE subcontractor for credit toward the Contract goal must include, in addition to any other requirements for subcontractor approval, the following:
  - a. A copy of the proposed subcontract. The subcontract must be for at least the dollar amount, and for the work described, in the Prime Contractor's Schedule of Participation.
  - b. A resume stating the qualifications and experience of the M/WBE or SDVOBE superintendent and/or foreperson who will supervise the on-site work. A new resume will be required for any change in supervisory personnel during the progress of the work.
  - c. A Schedule of Operations indicating when the M/WBE or SDVOBE is expected to perform the work.

- d. A list of (1) equipment owned by the M/WBE or SDVOBE to be used on the Project, and (2) equipment to be leased by the M/WBE or SDVOBE for use on the Project.
  - e. A list of: (1) all projects (public and private) which the M/WBE or SDVOBE is currently performing, (2) all projects (public and private) to which the M/WBE or SDVOBE is committed, (3) all projects (public and private) to which the M/WBE or SDVOBE intends to make a commitment. For each contract, list the contracting organization, the name and telephone number of a contact person for the contracting organization, the dollar value of the work, a description of the work, and the M/WBEs or SDVOBEs work schedule for each project.
5. If, pursuant to the subcontractor approval process, the Department finds that a M/WBE or SDVOBE subcontractor does not have sufficient experience or resources to perform, manage and supervise work of the kind proposed in accordance with the requirements of Section XIII(1), approval of the M/WBE or SDVOBE subcontractor may be denied. In the event of such denial, the Prime Contractor shall proceed in accordance with the requirements of Sections XIII(6) and XIII(10).
  6. If, for reasons beyond its control, the Prime Contractor cannot comply with its M/WBE or SDVOBE commitment in accordance with the Schedule of participation submitted under Section IX and the terms of these Special Provisions, the Prime Contractor shall submit to the Department the reasons for its inability to comply with its obligations under Section I and shall submit, and request approval for, a revised Schedule of Participation. If approved by the Department, the revised Schedule shall govern the Prime Contractor's performance in meeting its obligations under these special provisions.
  7. A Prime Contractor's compliance with the participation goal in Section I shall be determined by reference to the required percentage of the total Contract price, including any additions and modifications thereto, provided, however, that no decrease in the dollar amount of a bidder's commitment to any M/WBE or SDVOBE shall be allowed without the approval of the Department.
  8. If the Contract amount is increased, the Prime Contractor shall submit a revised Schedule of Participation in accordance with Sections XIII(6) and XIII(10).
  9. In the event of the decertification of a M/WBE or SDVOBE participating or scheduled to participate on the contract for credit toward the goal, the Contractor shall proceed in accordance with Sections XIII(6) and XIII(10).
  10. The Prime Contractor shall notify the Department immediately of any facts which come to its attention indicating that it may or will be unable to comply with any aspect of its M/WBE or SDVOBE obligation under this Contract.
  11. Any notice required by these Special Provisions shall be given in writing to the Resident Engineer and the district designated Compliance Officer with a copy to the Director of Compliance, Office of Diversity and Civil Rights, 10 Park Plaza, Room 3170, Boston MA 02116.
  12. The Prime Contractor and its subcontractors shall comply with the Department's Electronic Reporting System Requirements (Contract Document 00821) and submit all information required by the Department related to the M/WBE Special Provisions and SDVOBE Special Provisions through the Equitable Business Opportunity Solution (EBO). The Department reserves the right to request reports in the format it deems necessary anytime during the performance of the Contract.
  13. The Contractor shall pay each M/WBE or SDVOBE for satisfactory performance of its Contract no later than 10 days from receipt of payment for the work from the Department. Any delay or postponement of payment to the M/WBEs or SDVOBEs must be for good cause and only with the prior approval of the Department.
  14. The Department may withhold the Contractor's next periodic payment if each M/WBE or SDVOBE is not paid in accordance with Section XIII(13).
  15. The Department may require specific performance of the Prime Contractor's commitment under the Contract by requiring the Prime Contractor to subcontract with a M/WBE or SDVOBE for any contract or specialty item.

#### XIV. SANCTIONS

If the Prime Contractor does not comply with the terms of these Special Provisions and cannot demonstrate to the satisfaction of the Department that good faith efforts were made to achieve such compliance, the Department may, in addition to any other remedy provided for in the Contract, and notwithstanding any other provision in the Contract:

1. Retain, in connection with final acceptance and final payment, an amount determined by multiplying the total contract amount by the percentage in Section I, less the amount paid to approved M/WBEs or SDVOBEs for work performed under the Contract in accordance with the provisions of Section X. The Prime Contractor shall have the right to appeal such retention of funds in accordance with the provisions of M.G.L. c. 30A s.10.
2. Suspend, terminate or cancel this Contract, in whole or in part, and call upon the Prime Contractor's surety to perform all terms and conditions in the Contract.
3. In accordance with 720 CMR 5.05(1)(f), modify or revoke the Prime Contractor's Prequalification status or recommend that the Prime Contractor not receive award of a pending Contract. The Prime Contractor may appeal the determination of the Prequalification Committee in accordance with the provisions of 720 CMR 5.07.
4. Initiate debarment proceedings under M.G.L. c.29 §29F.

#### XV. FURTHER INFORMATION

Any proposed M/WBE, SDVOBE, bidder, Contractor or subcontractor shall provide such information as is necessary in the judgement of the Department to ascertain its compliance with the terms of this Special Provision.

#### XVI. LIST OF ADDITIONAL DOCUMENTS

1. The following documents shall be completed and signed by the bidder and designated M/WBEs or SDVOBEs in accordance with Section XII - Award Documentation and Procedures. These documents must be returned by the bidder to MassDOT's Bid Document Distribution Center:
  - Schedule of M/WBEs (Document B00842) or SDVOBE Participation (Document B00844)
  - Letter of Intent: M/WBEs (Document B00843) or SDVOBE (Document B00845)
  - M/WBEs or SDVOBE Joint Check Arrangement Approval Form (Document B00846), if Contractor and M/WBE or SDVOBE plan, or if M/WBE or SDVOBE is required to use a Joint Check (when applicable)
2. The following document shall be signed and returned by Contractor and Subcontractors/M/WBEs or SDVOBEs to the MassDOT District Office overseeing the Project, as applicable:
  - Contractor/Subcontractor Certification Form (Document No. 00859) (a checklist of other documents to be included with every subcontract (M/WBEs or SDVOBEs and non-M/WBEs or SDVOBEs alike)).
3. The following document shall be provided to MassDOT's Office of Civil Rights and Prequalification Office at least fourteen (14) business days before the bid opening date:
  - Joint Venture Affidavit of M/WBE or SDVOBE/Non-M/WBE or Non-SDVOBE (Document B00847)
4. The following document shall be provided to MassDOT's District Office of Civil Rights within 30 calendar days after the work of the DBE is completed, or no later than 30 calendar days after the work of the DBE is on a completed and processed CQE. This document shall be completed and submitted by the Prime Contractor:
  - Certificate of Completion by a Minority/Women or Disadvantaged Business Enterprise (M/W/DBE) (Form No. CSD-100)

\*\* END OF DOCUMENT \*\*

## DOCUMENT 00761

**SPECIAL PROVISIONS FOR CERTIFICATION REGARDING DEBARMENT,  
SUSPENSION, INELIGIBILITY AND VOLUNTARY EXCLUSION**

Revised: 02/09/16

**I. Instructions for Certification - Primary Covered Transactions:**

By signing and submitting this proposal, the prospective primary participant is providing the certification set out below.

1. The inability of a person to provide the certification set out below will not necessarily result in denial of participation in this covered transaction. The prospective participant shall submit an explanation of why it cannot provide the certification set out below. The certification or explanation will be considered in connection with the MassDOT's determination whether to enter into this transaction. However, failure of the prospective primary participant to furnish a certification or an explanation shall disqualify such a person from participation in this transaction.
2. The certification in this clause is a material representation of fact upon which reliance was placed when the MassDOT determined to enter into this transaction. If it is later determined that the prospective primary participant knowingly rendered an erroneous certification, in addition to other remedies available, the MassDOT may terminate this transaction for cause of default.
3. The prospective primary participant shall provide immediate written notice to the MassDOT if any time the prospective primary participant learns that its certification was erroneous when submitted or has become erroneous by reason of changed circumstances.
4. The terms "covered transaction," "debarred," "suspended," "ineligible," "lower tier covered transaction," "participant," "person," "primary covered transaction," "principal," "proposal," and "voluntarily excluded," as used in this clause, have the meanings set out in the Definitions and Coverage sections of rules implementing Executive Order 12549. You may contact the MassDOT for assistance in obtaining a copy of those regulations.
5. The prospective primary participant agrees by submitting this proposal that, should the proposed covered transaction be entered into, it shall not knowingly enter into any lower tier covered transaction with a person who is debarred, suspended, declared ineligible, or voluntarily excluded from participation in this covered transaction, unless authorized by the MassDOT.
6. The prospective primary participant further agrees by submitting this proposal that it will include the clause titled "Certification Regarding Debarment, Suspension, Ineligibility and Voluntary Exclusion-Lower Tier Covered Transaction," provided by the MassDOT, without modification, in all lower tier covered transactions and in all solicitations for lower tier covered transactions.
7. A participant in a covered transaction may rely upon a certification of a prospective participant in a lower tier covered transaction that is not debarred, suspended, ineligible, or voluntarily excluded from the covered transaction, unless it knows that the certification is erroneous. A participant may decide the method and frequency by which it determines the eligibility of its principals. Each participant may, but is not required to, check the nonprocurement portion of the "Lists of Parties Excluded From Federal Procurement or Nonprocurement Programs" (Nonprocurement List) which is compiled by the General Services Administration and the Debarment Lists compiled by both the Massachusetts Office of the Attorney General and the Department of Capital Asset Management and Maintenance (DCAMM) and published separately in the Central Register.
8. Nothing contained in the foregoing shall be construed to require establishment of a system of records in order to render in good faith the certification required by this clause. The knowledge and information of participant is not required to exceed that which is normally possessed by a prudent person in the ordinary course of business dealings.
9. Except for transactions authorized under paragraph 5 of these instructions, if a participant in a covered transaction knowingly enters into a lower tier covered transaction with a person who is suspended, debarred, ineligible, or voluntarily excluded from participation in this transaction, in addition to other remedies available, the MassDOT may terminate this transaction for cause or default.

\* \* \* \* \*

**Certification Regarding Debarment, Suspension, Ineligibility and Voluntary Exclusion -- Primary Covered Transactions**

The prospective primary participant certifies to the best of its knowledge and belief, that it and its principals:

1. Are not presently debarred, suspended, proposed for debarment, declared ineligible, or voluntarily excluded from covered transactions by any Federal, State or local department or agency;
2. Have not within a 3-year period preceding this proposal been convicted of or had a civil judgement rendered against them for commission of fraud or a criminal offense in connection with obtaining, attempting to obtain, or performing a public (Federal, State or local) transaction or contract under a public transaction; violation of Federal or State antitrust statutes or commission of embezzlement, theft, forgery, bribery, falsification or destruction of records, making false statements, or receiving stolen property;
3. Are not presently indicted for or otherwise criminally or civilly charged by a governmental entity (Federal, State or local) with commission of any of the offenses enumerated in paragraph 2 of this certification; and
4. Have not within a 3-year period preceding this application/proposal had one or more public transactions (Federal, State or local) terminated for cause or default.

Where the prospective primary participant is unable to certify to any of the statements in this certification, such prospective participant shall attach an explanation to this proposal.

\* \* \* \* \*

**II. Instructions for Certification - Lower Tier Covered Transactions:**

By signing and submitting this proposal, the prospective lower tier participant is providing the certification set out below.

1. The certification in this clause is a material representation of fact upon which reliance was placed when this transaction was entered into. If it is later determined that the prospective lower tier participant knowingly rendered an erroneous certification, in addition to other remedies available the MassDOT may pursue available remedies, including suspension and/or debarment.
2. The prospective lower tier participant shall provide immediate written notice to the person to which this proposal is submitted if at any time the prospective lower tier participant learns that its certification was erroneous by reason of changed circumstances.
3. The terms "covered transaction," "debarred," "suspended," "ineligible," "primary covered transaction," "participant," "person," "principal," "proposal," and "voluntarily excluded," as used in this clause, have the meanings set out in the Definitions and Coverage sections of rules implementing Executive Order 12549. You may contact the MassDOT for assistance in obtaining a copy of those regulations.
4. The prospective lower tier participant agrees by submitting this proposal that, should the proposed covered transaction be entered into, it shall not knowingly enter into any lower tier covered transaction with a person who is debarred, suspended, declared ineligible, or voluntarily excluded from participation in this covered transaction, unless authorized by the MassDOT.
5. The prospective lower tier participant further agrees by submitting this proposal that it will include this clause titled "Certification Regarding Debarment, Suspension, Ineligibility and Voluntary Exclusion-Lower Tier Covered Transaction," without modification, in all lower tier covered transactions and in all solicitations for lower tier covered transactions.
6. A participant in a covered transaction may rely upon a certification of a prospective participant in a lower tier covered transaction that is not debarred, suspended, ineligible, or voluntarily excluded from the covered transaction, unless it knows that the certification is erroneous. A participant may decide the method and frequency by which it determines the eligibility of its principals. Each participant may, but is not required to, check the Nonprocurement List and the Debarment Lists.



7. Nothing contained in the foregoing shall be construed to require establishment of a system of records in order to render in good faith the certification required by this clause. The knowledge and information of participant is not required to exceed that which is normally possessed by a prudent person in the ordinary course of business dealings.
8. Except for transactions authorized under paragraph 4 of these instructions, if a participant in a covered transaction knowingly enters into a lower tier covered transaction with a person who is suspended, debarred, ineligible, or voluntarily excluded from participation in this transaction, the MassDOT may pursue available remedies, including suspension and/or debarment.

\* \* \* \* \*

**Certification Regarding Debarment, Suspension, Ineligibility and Voluntary Exclusion - Lower Tier Covered Transactions**

The prospective lower tier participant certifies, by submission of this proposal, that neither it nor its principals is presently debarred, suspended, proposed for debarment, declared ineligible, or voluntarily excluded from participation in this transaction by any Federal, State or local department or agency.

Where the prospective lower tier participant is unable to certify to any of the statements in this certification, such prospective participant shall attach an explanation to this proposal.

\*\*\* END OF DOCUMENT \*\*\*

THIS PAGE INTENTIONALLY LEFT BLANK

DOCUMENT 00811

SPECIAL PROVISIONS  
MONTHLY PRICE ADJUSTMENT FOR HOT MIX ASPHALT (HMA) MIXTURES  
Revised: 02/03/2023

This provision applies to all projects using greater than 100 tons of hot mix asphalt (HMA) mixtures containing liquid asphalt cement as stipulated in the Notice to Contractors section of the bid documents.

Price Adjustments will be based on the variance in price, for the liquid asphalt component only, between the Base Price and the Period Price. They shall not include transportation or other charges. Price Adjustments will occur on a monthly basis.

**Base Price**

The Base Price of liquid asphalt on a project as listed in the Notice to Contractors section of the bid documents is a fixed price determined by the Department at the time of the bid using the same method as the determination of the Period Price detailed below. The Base Price shall be used in all bids.

**Period Price**

The Period Price is the price of liquid asphalt for each monthly period as determined by the Department using the average selling price per standard ton of PG64-28 paving grade (primary binder classification) asphalt, FOB manufacturer's terminal, as listed under the "East Coast Market - New England, Boston, Massachusetts area" section of the Poten & Partners, Inc. "Asphalt Weekly Monitor". This average selling price is listed in the issue having a publication date of the second Friday of the month and will be posted as the Period Price for that month. The Department will post this Period Price on its website at <https://www.mass.gov/service-details/massdot-current-contract-price-adjustments> following its receipt of the relevant issue of the "Asphalt Weekly Monitor". Poten and Partners has granted the Department the right to publish this specific asphalt price information sourced from the Asphalt Weekly Monitor.

**Price Adjustment Determination, Calculation and Payment**

The Contract Price of the HMA mixture will be paid under the respective item in the Contract. Price Adjustments, as herein provided, either upwards or downwards, will be made after the work has been performed using the monthly period price for the month during which the work was performed.

Price Adjustments will be paid only if the variance from the Base Price is 5% or more for a monthly period. The complete adjustment will be paid in all cases with no deduction of the 5% from either upward or downward adjustments.

The Price Adjustment applies only to the actual virgin liquid asphalt content in the mixture placed on the job in accordance with the approved Job Mix Formula.

Price Adjustments will be separate payment items. The pay item numbers are 999.401 for a positive price adjustment (a payment) and 999.402 for a negative price adjustment (a deduction). Price Adjustments will be calculated using the following equation:

Price Adjustment = Tons of HMA Placed X Liquid Asphalt Content % X RAP Factor X (Period Price - Base Price)

No Price Adjustment will be allowed beyond the Completion Date of this Contract, unless there is a Department-approved extension of time.

\*\*\*\*\* END OF DOCUMENT \*\*\*\*\*

THIS PAGE INTENTIONALLY LEFT BLANK

DOCUMENT 00812

SPECIAL PROVISIONS  
MONTHLY PRICE ADJUSTMENT FOR DIESEL FUEL AND GASOLINE –  
ENGLISH UNITS  
Revised: 02/01/2021

This monthly fuel price adjustment is inserted in this contract because the national and worldwide energy situation has made the future cost of fuel unpredictable. This adjustment will provide for either additional compensation to the Contractor or repayment to the Commonwealth, depending on an increase or decrease in the average price of diesel fuel or gasoline.

This adjustment will be based on fuel usage factors for various items of work developed by the Highway Research Board in Circular 158, dated July 1974. These factors will be multiplied by the quantities of work done in each item during each monthly period and further multiplied by the variance in price from the Base Price to the Period Price.

The Base Price of Diesel Fuel and Gasoline will be the price as indicated in the Department’s web site <https://www.mass.gov/service-details/massdot-current-contract-price-adjustments> for the month in which the contract was bid, which includes State Tax.

The Period Price will be the average of prices charged to the State, including State Tax for the bulk purchases made during each month.

This adjustment will be effected only if the variance from the Base Price is 5% or more for a monthly period. The complete adjustment will be paid in all cases with no deduction of the 5% from either upward or downward adjustments.

No adjustment will be paid for work done beyond the extended completion date of any contract.

Any adjustment (increase or decrease) to estimated quantities made to each item at the time of final payment will have the fuel price adjustment figured at the average period price for the entire term of the project for the difference of quantity.

The fuel price adjustment will apply only to the following items of work at the fuel factors shown:

| ITEMS COVERED  | FUEL FACTORS          |                      |
|--|-----------------------|----------------------|
|  | Diesel                | Gasoline             |
| Excavation: and Borrow Work:<br>Items 120, 120.1, 121, 123, 124, 125, 127, 129.3, 140, 140.1, 141, 142, 143, 144, 150, 150.1, 151 and 151.1<br>(Both Factors used) | 0.29<br>Gallons / CY. | 0.15<br>Gallons / CY |
| Surfacing Work:<br>All Items containing Hot Mix Asphalt  | 2.90<br>Gallons / Ton | Does Not Apply       |

\*\*\* END OF DOCUMENT \*\*\*

THIS PAGE INTENTIONALLY LEFT BLANK

## DOCUMENT 00813

## SPECIAL PROVISIONS

## PRICE ADJUSTMENTS FOR STRUCTURAL STEEL AND REINFORCING STEEL

October 18, 2023

This special provision applies to all projects containing the use of structural steel and/or reinforcing steel as specified elsewhere in the Contract work. It applies to all structural steel and all reinforcing steel, as defined below, on the project. Compliance with this provision is mandatory, i.e., there are no “opt-in” or “opt-out” clauses. Price adjustments will be handled as described below and shall only apply to unfabricated reinforcing steel bars and unfabricated structural steel material, consisting of rolled shapes, plate steel, sheet piling, pipe piles, steel castings and steel forgings.

Price adjustments will be variances between Base Prices and Period Prices. Base Prices and Period Prices are defined below.

Price adjustments will only be made if the variances between Base Prices and Period Prices are 5% or more. A variance can result in the Period Price being either higher or lower than the Base Price. Once the 5% threshold has been achieved, the adjustment will apply to the full variance between the Base Price and the Period Price.

Price adjustments will be calculated by multiplying the number of pounds of unfabricated structural steel material or unfabricated reinforcing steel bars on a project by the index factor calculated as shown below under Example of a Period Price Calculation.

Price adjustments will *not* include guardrail panels or the costs of shop drawing preparation, handling, fabrication, coatings, transportation, storage, installation, profit, overhead, fuel costs, fuel surcharges, or other such charges not related to the cost of the unfabricated structural steel and unfabricated reinforcing steel.

The weight of steel subject to a price adjustment shall not exceed the final shipping weight of the fabricated part by more than 10%.

Base Prices and Period Prices are defined as follows:

Base Prices of unfabricated structural steel and unfabricated reinforcing steel on a project are fixed prices determined by the Department and found in the table below. While it is the intention of the Department to make this table comprehensive, some of a project’s unfabricated structural steel and/or unfabricated reinforcing steel may be inadvertently omitted. Should this occur, the Contractor shall bring the omission to the Department’s attention so that a contract alteration may be processed that adds the missing steel to the table and its price adjustments to the Contract.

The Base Price Date is the month and year of the most recent finalized period price index at the time that MassDOT opened bids for the project. The Base Price Index for this contract is the Steel PPI listed in the Notice to Contractors.

Period Prices of unfabricated structural steel and unfabricated reinforcing steel on a project are variable prices that have been calculated using the Period Price Date and an index of steel prices to adjust the Base Price.

The Period Price Date is the date the steel was delivered to the fabricator as evidenced by an official bill of lading submitted to the Department containing a description of the shipped materials, weights of the shipped materials and the date of shipment. This date is used to select the Period Price Index.

The index used for the calculation of Period Prices is the U.S. Department of Labor Bureau of Labor Statistics Producer Price Index (PPI) Series ID WPU101702 (Not Seasonally Adjusted, Group: Metals and Metal Products, Item: Semi-finished Steel Mill Products.) As this index is subject to revision for a period of up to four (4) months after its original publication, no price adjustments will be made until the index for the period is finalized, i.e., the index is no longer suffixed with a “(P)”.

Period Prices are determined as follows:

Period Price = Base Price X Index Factor

Index Factor = Period Price Index / Base Price Index

Example of a Period Price Calculation:

Calculate the Period Price for December 2009 using a Base Price from March 2009 of \$0.82/Pound for 1,000 Pounds of ASTM A709 (AASHTO M270) Grade A36 Structural Steel Plate.

The Period Price Date is December 2009. From the PPI website\*, the Period Price Index = 218.0.

The Base Price Date is March 2009. From the PPI website\*, the Base Price Index = 229.4.

Index Factor = Period Price Index / Base Price Index = 218.0 / 229.4 = 0.950

Period Price = Base Price X Index Factor = \$0.82/Pound X 0.950 = \$0.78/Pound

Since \$0.82 - \$0.78 = \$0.04 is less than 5% of \$0.82, no price adjustment is required.

If the \$0.04 difference shown above was greater than 5% of the Base Price, then the price adjustment would be 1,000 Pounds X \$0.04/Pound = \$40.00. Since the Period Price of \$0.78/Pound is less than the Base Price of \$0.82/Pound, indicating a drop in the price of steel between the bid and the delivery of material, a credit of \$40.00 would be owed to MassDOT. When the Period Price is higher than the Base Price, the price adjustment is owed to the Contractor.

\* To access the PPI website and obtain a Base Price Index or a Period Price Index, go to

<http://data.bls.gov/cgi-bin/srgate>

End of example.

The Contractor will be paid for unfabricated structural steel and unfabricated reinforcing steel under the respective contract pay items for all components constructed of either structural steel or reinforced Portland cement concrete under their respective Contract Pay Items.

Price adjustments, as herein provided for, will be paid separately as follows:

Structural Steel

Pay Item Number 999.449 for positive (+) pay adjustments (payments to the Contractor)

Pay Item Number 999.457 for negative (-) pay adjustments (credits to MassDOT Highway Division)

Reinforcing Steel

Pay Item Number 999.466 for positive (+) pay adjustments (payments to the Contractor)

Pay Item Number 999.467 for negative (-) pay adjustments (credits to MassDOT Highway Division)

No price adjustment will be made for price changes after the Contract Completion Date, unless the MassDOT Highway Division has approved an extension of Contract Time for the Contract.



TABLE

| Steel Type | Price per Pound   |        |
|------------|---|--------|
| 1          | ASTM A615/A615M Grade 60 (AASHTO M31 Grade 60 or 420) Reinforcing Steel                                       | \$0.72 |
| 2          | ASTM A27 (AASHTO M103) Steel Castings, H-Pile Points & Pipe Pile Shoes (See Note below.)                      | \$0.98 |
| 3          | ASTM A668 / A668M (AASHTO M102) Steel Forgings  | \$0.98 |
| 4          | ASTM A108 (AASHTO M169) Steel Forgings for Shear Studs  | \$1.02 |
| 5          | ASTM A709/A709M Grade 36 / AASHTO M270M/M270 Grade 36 or 250 Structural Steel Plate                           | \$1.08 |
| 6          | ASTM A709/A709M Grade 36 / AASHTO M270M/M270 Grade 36 or 250 Structural Steel Shapes                          | \$1.01 |
| 7          | ASTM A709/A709M Grade 50 / AASHTO M270M/M270 Grade 50 or 345 Structural Steel Plate                           | \$1.08 |
| 8          | ASTM A709/A709M Grade 50 / AASHTO M270M/M270 Grade 50 or 345 Structural Steel Shapes                          | \$1.01 |
| 9          | ASTM A709/A709M Grade 50WT / AASHTO M270M/M270 Grade 50WT or 345WT Structural Steel Plate                     | \$1.12 |
| 10         | ASTM A709/A709M Grade 50WT / AASHTO M270M/M270 Grade 50WT or 345WT Structural Steel Shapes                    | \$1.02 |
| 11         | ASTM A709/A709M Grade 50W / AASHTO M270M/M270 Grade 50W 345W Structural Steel Plate                           | \$1.12 |
| 12         | ASTM A709/A709M Grade 50W / AASHTO M270M/M270 Grade 50W or 345W Structural Steel Shapes                       | \$1.02 |
| 13         | ASTM A709/A709M Grade HPS 50W / AASHTO M270M/M270 Grade HPS 50W or 345W Structural Steel Plate                | \$1.18 |
| 14         | ASTM A709/A709M Grade HPS 70W / AASHTO M270M/M270 Grade HPS 70W or 485W Structural Steel Plate                | \$1.25 |
| 15         | ASTM A514/A514M-05 Grade HPS 100W / AASHTO M270M/M270 Grade HPS 100W or 690W Structural Steel Plate           | \$1.92 |
| 16         | ASTM A992/A992M Grade 50S / AASHTO M270M/M270 Grade 50S or 345S Structural Steel Plate                        | \$1.12 |
| 17         | ASTM A992/A992M Grade 50S / AASHTO M270M/M270 Grade 50S or 345S Structural Steel Shapes                       | \$1.02 |
| 18         | ASTM A276 Type 316 Stainless Steel  | \$5.74 |
| 19         | ASTM A240 Type 316 Stainless Steel  | \$5.74 |
| 20         | ASTM A148 Grade 80/50 Steel Castings (See Note below.)  | \$1.98 |
| 21         | ASTM A53 Grade B Structural Steel Pipe  | \$1.26 |
| 22         | ASTM A500 Grades A, B, 36 & 50 Structural Steel Pipe  | \$1.26 |
| 23         | ASTM A252, Grades 240 (36 KSI) & 414 (60 KSI) Pipe Pile   | \$1.00 |
| 24         | ASTM 252, Grade 2 Permanent Steel Casing  | \$1.00 |
| 25         | ASTM A36 (AASHTO M183) for H-piles, steel supports and sign supports  | \$1.07 |
| 26         | ASTM A328 / A328M, Grade 50 (AASHTO M202) Steel Sheetpiling   | \$1.89 |
| 27         | ASTM A572 / A572M, Grade 50 Sheetpiling   | \$1.89 |
| 28         | ASTM A36/36M, Grade 50  | \$1.08 |
| 29         | ASTM A570, Grade 50   | \$1.07 |
| 30         | ASTM A572 (AASHTO M223), Grade 50 H-Piles   | \$1.08 |
| 31         | ASTM A1085 Grade A (50 KSI) Steel Hollow Structural Sections (HSS), heat-treated per ASTM A1085 Supplement S1 | \$1.26 |
| 32         | AREA 140 LB Rail and Track Accessories  | \$0.65 |

**NOTE:** Steel Castings are generally used only on moveable bridges. Cast iron frames, grates and pipe are not "steel" castings and will not be considered for price adjustments.

END OF DOCUMENT

THIS PAGE INTENTIONALLY LEFT BLANK

DOCUMENT 00814

SPECIAL PROVISIONS  
PRICE ADJUSTMENT FOR PORTLAND CEMENT CONCRETE MIXES

January 12, 2009

This provision applies to all projects using greater than 100 Cubic Yards (76 Cubic Meters) of Portland cement concrete containing Portland cement as stipulated in the Notice to Contractors section of the Bid Documents. This Price Adjustment will occur on a monthly basis.

The Price Adjustment will be based on the variance in price for the Portland cement component only from the Base Price to the Period Price. It shall not include transportation or other charges.

The Base Price of Portland cement on a project is a fixed price determined at the time of bid by the Department by using the same method as for the determination of the Period Price (see below) and found in the Notice to Contractors.

The Period Price of Portland cement will be determined by using the latest published price, in dollars per ton (U.S.), for Portland cement (Type I) quoted for Boston, U.S.A. in the **Construction Economics** section of *ENR Engineering News-Record* magazine or at the ENR website <http://www.enr.com> under **Construction Economics**. The Period Price will be posted on the MassDOT website the Wednesday immediately following the publishing of the monthly price in ENR, which is normally the first week of the month.

The Contract Price of the Portland cement concrete mix will be paid under the respective item in the Contract. The price adjustment, as herein provided, upwards or downwards, will be made after the work has been performed, using the monthly period price for the month during which the work was performed.

The price adjustment applies only to the actual Portland cement content in the mix placed on the job in accordance with the Standard Specifications for Highways and Bridges, Division III, Section M4.02.01. No adjustments will be made for any cement replacement materials such as fly ash or ground granulated blast furnace slag.

The Price Adjustment will be a separate payment item. It will be determined by multiplying the number of cubic yards of Portland cement concrete placed during each monthly period times the Portland cement content percentage times the variance in price between the Base Price and Period Price of Portland cement.

This Price Adjustment will be paid only if the variance from the Base Price is 5% or more for a monthly period. The complete adjustment will be paid in all cases with no deduction of the 5% from either upward or downward adjustments.

No Price Adjustment will be allowed beyond the Completion Date of this Contract, unless there is a Department-approved extension of time.

\*\*\* END OF DOCUMENT \*\*\*

THIS PAGE INTENTIONALLY LEFT BLANK

DOCUMENT 00820

**THE COMMONWEALTH OF MASSACHUSETTS  
SUPPLEMENTAL EQUAL EMPLOYMENT OPPORTUNITY,  
NON-DISCRIMINATION AND AFFIRMATIVE ACTION PROGRAM**

I. Definitions

For purposes of this contract,

"Minority" means a person who meets one or more of the following definitions:

- (a) American Indian or Native American means: all persons having origins in any of the original peoples of North America and who are recognized as an Indian by a tribe or tribal organization.
- (b) Asian means: All persons having origins in any of the original peoples of the Far East, Southeast Asia, the Indian sub-continent, or the Pacific Islands, including, but Not limited to China, Japan, Korea, Samoa, India, and the Philippine Islands.
- (c) Black means: All persons having origins in any of the Black racial groups of Africa, including, but not limited to, African-Americans, and all persons having origins in any of the original peoples of the Cape Verdean Islands.
- (d) Eskimo or Aleut means: All persons having origins in any of the peoples of Northern Canada, Greenland, Alaska, and Eastern Siberia.
- (e) Hispanic means: All persons having their origins in any of the Spanish-speaking peoples of Mexico, Puerto Rico, Cuba, Central or South America, or the Caribbean Islands.

"State construction contract" means a contract for the construction, reconstruction, installation, demolition, maintenance or repair of a building or capital facility, or a contract for the construction, reconstruction, alteration, remodeling or repair of a public work undertaken by a department, agency, board, or commission of the commonwealth.

"State assisted construction contract" means a contract for the construction, reconstruction, installation, demolition, maintenance or repair of a building or capital facility undertaken by a political subdivision of the commonwealth, or two or more political subdivisions thereof, an authority, or other instrumentality and whose costs of the contract are paid for, reimbursed, grant funded, or otherwise supported, in whole or in part, by the commonwealth.

II. Equal Opportunity, Non-Discrimination and Affirmative Action

During the performance of this Contract, the Contractor and all subcontractors (hereinafter collectively referred to as "the Contractor") for a state construction contract or a state assisted construction contract, for him/herself, his/her assignees and successors in interest, agree to comply with all applicable equal employment opportunity, non-discrimination and affirmative action requirements, including but not limited to the following:

In connection with the performance of work under this contract, the Contractor shall not discriminate against any employee or applicant for employment because of race, color, religious creed, national origin, sex, sexual orientation, genetic information, military service, age, ancestry or disability, shall not discriminate in the selection or retention of subcontractors, and shall not discriminate in the procurement of materials and rentals of equipment.

The aforesaid provision shall include, but not be limited to, the following: employment upgrading, demotion, or transfer; recruitment advertising, layoff or termination; rates of pay or other forms of compensation; conditions or privileges of employment; and selection for apprenticeship or on-the-job training opportunity. The Contractor shall comply with the provisions of chapter 151B of the Massachusetts General Laws, as amended, and all other applicable anti-discrimination and equal opportunity laws, all of which are herein incorporated by reference and made a part of this Contract.

The Contractor shall post hereafter in conspicuous places, available for employees and applicants for employment, notices to be provided by the Massachusetts Commission Against Discrimination setting forth the provisions of the Fair Employment Practices Law of the Commonwealth (Massachusetts General Laws Chapter 151 B).

In connection with the performance of work under this contract, the Contractor shall undertake, in good faith, affirmative action measures to eliminate any discriminatory barriers in the terms and conditions of employment on the grounds of race, color, religious creed, national origin, sex, sexual orientation, genetic information, military service, age, ancestry or disability. Such affirmative action measures shall entail positive and aggressive measures to ensure nondiscrimination and to promote equal opportunity in the areas of hiring, upgrading, demotion or transfer, recruitment, layoff or termination, rate of compensation, apprenticeship and on-the-job training programs. A list of positive and aggressive measures shall include, but not be limited to, advertising employment opportunities in minority and other community news media; notifying minority, women and other community-based organizations of employment opportunities; validating all job specifications, selection requirements, and tests; maintaining a file of names and addresses of each worker referred to the Contractor and what action was taken concerning such worker; and notifying the administering agency in writing when a union with whom the Contractor has a collective bargaining agreement has failed to refer a minority or woman worker. These and other affirmative action measures shall include all actions required to guarantee equal employment opportunity for all persons, regardless of race, color, religious creed, national origin, sex, sexual orientation, genetic information, military service, age, ancestry or disability. One purpose of this provision is to ensure to the fullest extent possible an adequate supply of skilled tradesmen for this and future Commonwealth public construction projects.

### III. Minority and Women Workforce Participation

Pursuant to his/her obligations under the preceding section, the Contractor shall strive to achieve on this project the labor participation goals contained herein. Said participation goals shall apply in each job category on this project including but not limited to bricklayers, carpenters, cement masons, electricians, ironworkers, operating engineers and those classes of work enumerated in Section 44F of Chapter 149 of the Massachusetts General Laws. The participation goals for this project shall be 15.3% for minorities and 6.9% for women. The participation goals, as set forth herein, shall not be construed as quotas or set-asides; rather, such participation goals will be used to measure the progress of the Commonwealth's equal opportunity, non-discrimination and affirmative action program. Additionally, the participation goals contained herein should not be seen or treated as a floor or as a ceiling for the employment of particular individuals or group of individuals.

#### IV. Liaison Committee

At the discretion of the agency that administers the contract for the construction project there may be established for the life of the contract a body to be known as the Liaison Committee. The Liaison Committee shall be composed of one representative each from the agency or agencies administering the contract for the construction project, hereinafter called the administering agency, a representative from the Office of Affirmative action, and such other representatives as may be designated by the administering agency. The Contractor (or his/her agent, if any, designated by him/her as the on-site equal employment opportunity officer) shall recognize the Liaison Committee as an affirmative action body, and shall establish a continuing working relationship with the Liaison Committee, consulting with the Liaison Committee on all matters related to minority recruitment, referral, employment and training.

#### V. Reports and Records

The Contractor shall prepare projected workforce tables on a quarterly basis when required by the administering agency. These shall be broken down into projections, by week, of workers required in each trade. Copies shall be furnished one week in advance of the commencement of the period covered, and also, when updated, to the administering agency and the Liaison Committee when required.

The Contractor shall prepare weekly reports in a form approved by the administering agency, unless information required is required to be reported electronically by the administering agency, the number of hours worked in each trade by each employee, identified as woman, minority, or non-minority. Copies of these shall be provided at the end of each such week to the administering agency and the Liaison Committee.

Records of employment referral orders, prepared by the Contractor, shall be made available to the administering agency on request.

The Contractor will provide all information and reports required by the administering agency on instructions issued by the administering agency and will permit access to its facilities and any books, records, accounts and other sources of information which may be determined by the administering agency to effect the employment of personnel. This provision shall apply only to information pertinent to the Commonwealth's supplementary non-discrimination, equal opportunity and access and opportunity contract requirements. Where information required is in the exclusive possession of another who fails or refuses to furnish this information, the Contractor shall so certify to the administering agency and shall set forth what efforts he has made to obtain the information.

#### VI. Access to Work Site

A designee of the administering agency and a designee of the Liaison Committee shall each have a right to access the work site.

#### VII. Solicitations for Subcontracts, and for the Procurement of Materials and Equipment

In all solicitations either by competitive bidding or negotiation made by the Contractor either for work to be performed under a subcontract or for the procurement of materials or equipment, each potential subcontractor or supplier shall be notified in writing by the Contractor of the Contractor's obligations under this contract relative to non-discrimination and equal opportunity.

## VIII. Sanctions

Whenever the administering agency believes the General or Prime Contractor or any subcontractor may not be operating in compliance with the provisions of the Fair Employment Practices Law of the Commonwealth (Massachusetts General Laws Chapter 151B), the administering agency may refer the matter to the Massachusetts Commission Against Discrimination ("Commission") for investigation.

Following the referral of a matter by the administering agency to the Massachusetts Commission Against Discrimination, and while the matter is pending before the MCAD, the administering agency may withhold payments from contractors and subcontractors when it has documentation that the contractor or subcontractor has violated the Fair Employment Practices Law with respect to its activities on the Project, or if the administering agency determines that the contractor has materially failed to comply with its obligations and the requirements of this Section. The amount withheld shall not exceed a withhold of payment to the General or Prime Contractor of 1/100 or 1% of the contract award price or \$5,000, whichever sum is greater, or, if a subcontractor is in non-compliance, a withhold by the administering agency from the General Contractor, to be assessed by the General Contractor as a charge against the subcontractor, of 1/100 or 1% of the subcontractor price, or \$1,000 whichever sum is greater, for each violation of the applicable law or contract requirements. The total withheld from anyone General or Prime Contractor or subcontractor on a Project shall not exceed \$20,000 overall. No withhold of payments or investigation by the Commission or its agent shall be initiated without the administering agency providing prior notice to the Contractor.

If, after investigation, the Massachusetts Commission Against Discrimination finds that a General or Prime Contractor or subcontractor, in commission of a state construction contract or state-assisted construction contract, violated the provisions of the Fair Employment Practices Law, the administering agency may convert the amount withheld as set forth above into a permanent sanction, as a permanent deduct from payments to the General or Prime Contractor or subcontractor, which sanction will be in addition to any such sanctions, fines or penalties imposed by the Massachusetts Commission Against Discrimination.

No sanction enumerated under this Section shall be imposed by the administering agency except after notice to the General or Prime Contractor or subcontractor and an adjudicatory proceeding, as that term is used, under Massachusetts General Laws Chapter 30A, has been conducted.

## IX. Severability

The provisions of this section are severable, and if any of these provisions shall be held unconstitutional by any court of competent jurisdiction, the decision of such court shall not affect or impair any of the remaining provisions.



X. Contractor's Certification

After award and prior to the execution of any contract for a state construction contract or a state assisted construction contract, the Prime or General Contractor shall certify that it will comply with all provisions of this Document 00820 Supplemental Equal Employment Opportunity, Non-Discrimination and Affirmative Action Program, by executing Document 00859 Contractor/Subcontractor Certification Form.

XI. Subcontractor Requirements

Prior to the award of any subcontract for a state construction contract or a state assisted construction contract, the Prime or General Contractor shall provide all prospective subcontractors with a complete copy of this Document 00820 entitled "Supplemental Equal Employment Opportunity, Non-Discrimination and Affirmative Action Program" and will incorporate the provisions of this Document 00820 into any and all contracts or work orders for all subcontractors providing work on the Project. In order to ensure that the said subcontractor's certification becomes a part of all subcontracts under the prime contract, the Prime or General Contractor shall certify in writing to the administering agency that it has complied with the requirements as set forth in the preceding paragraph by executing Document 00859 Contractor/Subcontractor Certification Form.

*Rev'd 03/07/14*

\*\*\* END OF DOCUMENT \*\*\*

THIS PAGE INTENTIONALLY LEFT BLANK

## DOCUMENT 00821

ELECTRONIC REPORTING REQUIREMENTS  
CIVIL RIGHTS PROGRAMS AND CERTIFIED PAYROLL

Implemented on March 2, 2009

Revised June 04, 2019

The Massachusetts Department Of Transportation (MassDOT) has replaced the CHAMP reporting system with Equitable Business Opportunity Solution (EBO), a new web-based civil rights reporting software system. This system is capable of handling both civil rights reporting requirements and certified payrolls. The program's functions include the administration of Equal Employment Opportunity (EEO) requirements, On-The-Job Training requirements (OJT), Disadvantage Business Enterprise (DBE) and/or Minority / Women's Business Enterprise (M/WBE) subcontracting requirements, and the electronic collection of certified payrolls associated with MassDOT projects. In addition, this system is used to generate various data required as part of the American Recovery and Reinvestment Act (ARRA). Contractors are responsible for all coordination with all sub-contractors to ensure timely and accurate electronic submission of all required data.

**Contractor and Sub-Contractor EBO User Certification**

All contractors and sub-contractors must use the EBO software system. The software vendor, Internet Government Solutions (IGS), has developed an online EBO Training Module that is available to contractors and sub-contractors. This module is a self-tutorial which allows all users in the company to access the training, complete the tutorial, and become certified as EBO users for a one time fee of \$75.00. This is the only cost to contractors and sub-contractors associated with the EBO software system. The online EBO Training Module can be accessed at [www.ebotraining.com](http://www.ebotraining.com). Click the "Register My Company" button on the login page to begin your training registration. Questions regarding EBO online training should be directed to Gerry Anguilano, IGS at (440) 238-1684.

MassDOT will track contractors and sub-contractors who have successfully completed the on-line training module. All persons performing civil rights program and/or certified payroll functions should be EBO certified.

**Vetting of Firms and Designated Firm Individuals**

Contractors must authorize a Primary Log-In ID Holder who has completed EBO on-line training to have access to the EBO system by completing and submitting the "Request For EBO System Log-In/Password Form" located on the MassDOT website at: <https://www.mass.gov/how-to/how-to-get-an-ebo-login>. Contractors must also agree to comply with the EBO system user agreement located on the MassDOT website.

All subcontracts entered into on a project must include language that identifies the submission and training requirements that the sub-contractor must perform. Sub-contractors will be approved by the respective District Office of MassDOT through the existing approval process. When new sub-contractors, who have not previously worked for MassDOT, are initially selected by a general contractor, the new sub-contractor must be approved by the District before taking the EBO on-line training module.

**Interim Reporting Requirements**

Until MassDOT is satisfied that the EBO system is fully operational and functioning as designed, contractors and sub-contractors will be required to submit certified payrolls manually. There will be a transition period where dual reporting, through manual and electronic submission, will be required. MassDOT, however, will notify contractors and sub-contractors when they may cease manual submission of certified payrolls.

\*\*\* END OF DOCUMENT \*\*\*

THIS PAGE INTENTIONALLY LEFT BLANK

DOCUMENT 00859

**CONTRACTOR/SUBCONTRACTOR CERTIFICATION FORM ‡***The Contractor shall submit this completed Document 00859 to MassDOT for each subcontract.*\_\_\_\_\_ (Contractor)                      **Date:** \_\_\_\_\_\_\_\_\_\_ (Subcontractor)                       District Approved Subcontractor**Contract No:** 124171      **Project No:** 607680      **Federal Aid No:** NFA**Location:** Fitchburg**Project Description:** Bridge Rehabilitation, F-04-010, River Street (ST 31) over North Nashua River

**PART 1 CONTRACTOR CERTIFICATION:** I hereby certify, as an authorized official of this company, that to the best of my knowledge, information and belief, the company is in compliance with all applicable federal and state laws, rules, and regulations governing fair labor and employment practices, that the company will not discriminate in their employment practices, that the company will make good faith efforts to comply with the minority employee and women employee workforce participation ratio goals and specific affirmative action steps contained in Contract Document 00820 The Commonwealth of Massachusetts Supplemental Equal Employment Opportunity, Non-Discrimination and Affirmative Action Program, and that the company will comply with the special provisions and documentation indicated below (as checked).

I further hereby certify, as an authorized official of this company, that the special provisions and documentation indicated below (as checked) have been or are included in, and made part of, the Subcontractor Agreement entered into with the firm named above.

 **This is not a Federally-aided construction project****Document #**

- 00718 – Participation By Minority Or Women's Business Enterprises and SDVOBE†
- 00761 – Certification Regarding Debarment, Suspension, Ineligibility, and Voluntary Exclusion
- 00820 – MA Supplemental Equal Employment Opportunity, Non-Discrimination, and Affirmative Action Program
- 00821 – Electronic Reporting Requirements, Civil Rights Programs, and Certified Payroll
- 00859 – Contractor/Subcontractor Certification Form (this document)
- 00860 – MA Employment Laws
- 00861 – Applicable State Wage Rates in the Contract Proposal\*\*
- B00842 – MA Schedule of Participation By Minority or Women Business Enterprises (M/WBEs)†
- B00843 – MA Letter of Intent – M/WBEs†
  - \*\* Does not apply to Material Suppliers, unless performing work on-site
  - † Applies only if Subcontractor is a M/WBE; only include these forms for the particular M/WBE Entity
- B00844 – Schedule of Participation By SDVOBE
- B00845 - Letter of Intent – SDVOBE
- B00846 – M/WBE or SDVOBE Joint Check Arrangement Approval Form
- B00847 – Joint Venture Affidavit

 **This is a Federally-aided construction project (Federal Aid Number is present)****Document #**

- 00719 – Special Provisions for Participation by Disadvantaged Business Enterprises†
- 00760 - Form FHWA 1273 - Required Contract Provisions for Federal-Aid Construction Contracts
- 00820 – MA Supplemental Equal Employment Opportunity, Non-Discrimination and Affirmative Action Program
- 00821 – Electronic Reporting Requirements, Civil Rights Programs and Certified Payroll
- 00859 – Contractor/Subcontractor Certification Form (this document)
- 00860 – MA Employment Laws
- 00870 – Standard Federal Equal Employment Opportunity Construction Contract Specifications Executive Order 11246, (41 CFR Parts 60-4.2 and 60-4.3 (Solicitations and Equal Opportunity Clauses)\*
- 00875 – Federal Trainee Special Provisions

- B00853 – Schedule of Participation by Disadvantaged Business Enterprise†
- B00854 – Letter of Intent – DBEs†
- B00855 – DBE Joint Check Arrangement Approval Form
- B00856 – Joint Venture Affidavit
- 00861/00880 – Applicable state and federal wage rates from Contract Proposal\*\*

\*Applicable only to Contracts or Subcontracts in excess of \$10,000

\*\*Does not apply to Material Suppliers, unless performing work on-site

† Applies only if Subcontractor is a DBE; only include these forms for the particular DBE Entity

Signed this \_\_\_\_\_ Day of \_\_\_\_\_, 20\_\_\_\_ Under The Pains And Penalties Of Perjury.

\_\_\_\_\_  
(Print Name and Title)

\_\_\_\_\_  
(Authorized Signature)

**PART 2**

**PART 2 SUBCONTRACTOR CERTIFICATION:** I hereby certify, as an authorized official of this company, that the required documents in Part 1 above were physically incorporated in our Agreement/Subcontract with the Contractor and give assurance that this company will fully comply or make every good faith effort to comply with the same. I further certify that:

1. This company recognizes that if this is a Federal-Aid Project, then this Contract is covered by the equal employment opportunity laws administered and enforced by the United States Department of Labor (“USDOL”), Office of Federal Contract Compliance Programs (“OFCCP”). By signing below, we acknowledge that this company has certain reporting obligations to the OFCCP, as specified by 41 CFR Part 60-4.2.
2. This company further acknowledges that any contractor with fifty (50) or more employees on a Federal-aid Contract with a value of fifty-thousand (\$50,000) dollars or more must annually file an EEO-1 Report (SF 100) to the EEOC, Joint Reporting Committee, on or before September 30th, each year, as specified by 41 CFR Part 60-1.7a.
3. For more information regarding the federal reporting requirements, please contact the USDOL, OFCCP Regional Office, at 1-646-264-3170 or EEO-1, Joint Reporting Committee at 1-866-286-6440. You may also find guidance at: <http://www.dol.gov/ofccp/TAGuides/consttag.pdf> or <http://www.wdol.gov/dba.aspx#0>.
4. This company  has,  has not, participated in a previous contract or subcontract subject to the Equal Opportunity clauses set forth in 41 CFR Part 60-4 and Executive Order 11246, and where required, has filed with the Joint Reporting Committee, the Director of the Office of Federal Contract Compliance Programs or the EEO Commission all reports due under the applicable filing requirements.
5. This company is in full compliance with applicable Federal and Commonwealth of Massachusetts laws, rules, and regulations and is not currently debarred or disqualified from bidding on or participating in construction contracts in any jurisdiction of the United States. See : <https://www.mass.gov/service-details/contractors-and-vendors-suspended-or-debarred-by-massdot>
6. This company is properly registered and in good standing with the Office of the Secretary of the Commonwealth.

Signed this \_\_\_\_\_ Day of \_\_\_\_\_, 20\_\_\_\_, Under The Pains And Penalties Of Perjury.

Firm: \_\_\_\_\_

Address: \_\_\_\_\_

\_\_\_\_\_  
(Print Name and Title)

Telephone Number: \_\_\_\_\_

Federal I.D. Number: \_\_\_\_\_

\_\_\_\_\_  
(Authorized Signature)

Estimated Start Date: \_\_\_\_\_

Estimated Completion Date: \_\_\_\_\_

Estimated Dollar Amount: \_\_\_\_\_

\_\_\_\_\_  
(Date)

DOCUMENT 00860

**COMMONWEALTH OF MASSACHUSETTS PUBLIC EMPLOYMENT LAWS**

Revised February 20, 2019

The Contractor's attention is directed to Massachusetts General Laws, Chapter 149, Sections 26 through 27H, and 150A. This contract is considered to fall within the ambit of that law, which provides that in general, the Prevailing Rate or Total Rate must be paid to employees working on projects funded by the Commonwealth of Massachusetts or any political subdivision including Massachusetts Department of Transportation (MassDOT).

A Federal Aid project is also subject to the Federal Minimum Wage Rate law for construction. When comparing a state minimum wage rate, monitored by the Massachusetts Attorney General, versus federal minimum wage rate, monitored by the U.S. Department of Labor Wage and Hour Division, for a particular job classification the higher wage is at all times to be paid to the affected employee.

Every contractor or subcontractor engaged in this contract to which sections twenty-seven and twenty-seven A apply will keep a true and accurate record of all mechanics and apprentices, teamsters, chauffeurs and laborers employed thereon, showing the name, address and occupational classification of each such employee on this contract, and the hours worked by, and the wages paid to, each such employee, and shall furnish to the MassDOT's Resident Engineer, on a weekly basis, a copy of said record, in a form approved by MassDOT and in accordance with M.G.L. c. 149, § 27B, signed by the employer or his/her authorized agent under the penalties of perjury.

Each such contractor or subcontractor shall preserve its payroll records for a period of three years from the date of completion of the contract.

The Prevailing Wage Rate generally includes the following:

Minimum Hourly Wage + Employer Contributions to Benefit Plans = Prevailing Wage Rate or Total Rate

Any employer who does not make contributions to Benefit Plans must pay the total Prevailing Wage Rate directly to the employee.

Any deduction from the Prevailing Wage Rate or Total Rate for contributions to benefit plans can only be for a Health & Welfare, Pension, or Supplementary Unemployment plan meeting the requirements of the Employee Retirement Income Security Act (ERISA) of 1974. The maximum allowable deduction for these benefits from the prevailing wage rate cannot be greater than the amount allowed by Executive Office of Labor (EOL) for the specified benefits. Any additional expense of providing benefits to the employees is to be borne by the employer and cannot be deducted from the Minimum Hourly Wage. If the employer's benefit expense is less than that so provided by EOL the difference will be paid directly to the employee. The rate established must be paid to all employees who perform work on the project.

When an employer makes deductions from the Minimum Hourly Wage for an employee's contribution to social security, state taxes, federal taxes, and/or other contribution programs, allowed by law, the employer shall furnish each employee a suitable pay slip, check stub or envelope notifying the employee of the amount of the deductions.

No contractor or subcontractor contracting for any part of the contract week shall require or permit any laborer or mechanic to be employed on such work in excess of forty hours in any workweek unless such laborer or mechanic receives compensation at a rate not less than one and one-half times his basic rate of pay for all hours worked in excess of forty hours in such workweek, whichever is the greater number of overtime hours.

Apprentice Rates are permitted only when there is an Apprentice Agreement registered with the Massachusetts Division of Apprentice Training in accordance with M.G.L. c. 23, § 11E-11L.

The Prevailing Wage Rates issued for each project shall be the rates paid for the entire project. The Prevailing Wage Rates must be posted on the job site at all times and be visible from a public way.

In addition, each such contractor and subcontractor shall furnish to the MassDOT's Resident Engineer, within fifteen days after completion of its portion of the work, a statement, executed by the contractor or subcontractor or by any authorized officer or employee of the contractor or subcontractor who supervises the payment of wages, in the following form:

STATEMENT OF COMPLIANCE

Date: \_\_\_\_\_

I, \_\_\_\_\_ do hereby state:  
(Name of signatory party) (Title)

That I pay or supervise the payment of the persons employed by:

\_\_\_\_\_  
(Contractor or Subcontractor)

on the \_\_\_\_\_  
(MassDOT Project Location and Contract Number)

and that all mechanics and apprentices, teamsters, chauffeurs and laborers employed on said project have been paid in accordance with wages determined under the provisions of sections twenty-six and twenty-seven of chapter one hundred and forty-nine of the General Laws.

Signature \_\_\_\_\_

Title \_\_\_\_\_

The above-mentioned copies of payroll records and statements of compliance shall be available for inspection by any interested party filing a written request to the MassDOT's Resident Engineer for such inspection and copying.

Massachusetts General Laws c. 149, §27, requires annual updates to prevailing wage schedules for all public construction contracts lasting longer than one year. MassDOT will request the required updates and furnish them to the Contractor. The Contractor is required to pay no less than the wage rates indicated on the annual updated wage schedules.

MassDOT will request the updates no later that two week before the anniversary of the Notice to Proceed date of the contract to allow for adequate processing by the Department of Labor Standards (DLS). The effective date for the new rates will be the anniversary date of the contract (i.e. the notice to proceed date), regardless of the date of issuance on the schedule from DLS.

All bidders are cautioned that the aforementioned laws require that employers pay to covered employees no less than the applicable minimum wages. In addition, the same laws require that the applicable prevailing wages become incorporated as part of this contract. The prevailing minimum wage law establishes serious civil and criminal penalties for violations, including imprisonment and exclusion from future public contracts. Bidders are cautioned to carefully read the relevant sections of the Massachusetts General Laws.

\*\*\* END OF DOCUMENT \*\*\*



DOCUMENT 00861

# STATE PREVAILING WAGE RATES

THIS PAGE INTENTIONALLY LEFT BLANK



MAURA HEALEY  
Governor

KIM DRISCOLL  
Lt. Governor

THE COMMONWEALTH OF MASSACHUSETTS  
EXECUTIVE OFFICE OF LABOR AND WORKFORCE DEVELOPMENT  
DEPARTMENT OF LABOR STANDARDS

**Prevailing Wage Rates**

As determined by the Director under the provisions of the  
Massachusetts General Laws, Chapter 149, Sections 26 to 27H

LAUREN JONES  
Secretary

MICHAEL FLANAGAN  
Director

**Awarding Authority:** MassDOT Highway  
**Contract Number:** 124171 **City/Town:** FITCHBURG  
**Description of Work:** FITCHBURG: Bridge Rehabilitation, F-04-010, River Street (ST 31) over North Nashua River

**Job Location:** River Street (ST31) over North Nashua River

---

**Information about Prevailing Wage Schedules for Awarding Authorities and Contractors**

- **The wage rates will remain in effect for the duration of the project, except in the case of multi-year public construction projects. For construction projects lasting longer than one year, awarding authorities must request an updated wage schedule no later than two weeks before the anniversary of the date the contract was executed by the awarding authority and the general contractor.** For multi-year CM AT RISK projects, the awarding authority must request an annual update no later than two weeks before the anniversary date, determined as the earlier of: (a) the execution date of the GMP Amendment, or (b) the execution date of the first amendment to permit procurement of construction services. The annual update requirement is not applicable to 27F "rental of equipment" contracts. **The updated wage schedule must be provided to all contractors, including general and sub-contractors, working on the construction project.**
- This wage schedule applies only to the specific project referenced at the top of this page and uniquely identified by the "Wage Request Number" on all pages of this schedule.
- An Awarding Authority must request an updated wage schedule if it has not opened bids or selected a contractor within 90 days of the date of issuance of the wage schedule. For CM AT RISK projects (bid pursuant to G.L. c.149A), the earlier of: (a) the execution date of the GMP Amendment, or (b) the bid for the first construction scope of work must be within 90-days of the wage schedule issuance date.
- The wage schedule shall be incorporated in any advertisement or call for bids for the project as required by M.G.L. c. 149, § 27. The wage schedule shall be made a part of the contract awarded for the project. The wage schedule must be posted in a conspicuous place at the work site for the life of the project in accordance with M.G.L. c. 149 § 27. The wages listed on the wage schedule must be paid to employees performing construction work on the project whether they are employed by the prime contractor, a filed sub-bidder, or a sub-contractor.
- Apprentices working on the project are required to be registered with the Massachusetts Division of Apprentice Standards (DAS). Apprentices must keep their apprentice identification card on their persons during all work hours on the project. An apprentice registered with DAS may be paid the lower apprentice wage rate at the applicable step as provided on the prevailing wage schedule. **Any apprentice not registered with DAS regardless of whether they are registered with another federal, state, local, or private agency must be paid the journeyworker's rate.**
- Every contractor or subcontractor working on the construction project must submit weekly payroll reports and a Statement of Compliance directly to the awarding authority by mail or email and keep them on file for three years. Each weekly payroll report must contain: the employee's name, address, occupational classification, hours worked, and wages paid. Do not submit weekly payroll reports to DLS. For a sample payroll reporting form go to <http://www.mass.gov/dols/pw>.
- Contractors with questions about the wage rates or classifications included on the wage schedule have an affirmative obligation to inquire with DLS at (617) 626-6953.
- Contractors must obtain the wage schedules from awarding authorities. Failure of a contractor or subcontractor to pay the prevailing wage rates listed on the wage schedule to all employees who perform construction work on the project is a violation of the law and subjects the contractor or subcontractor to civil and criminal penalties.
- Employees not receiving the prevailing wage rate set forth on the wage schedule may file a complaint with the Fair Labor Division of the office of the Attorney General at (617) 727-3465.

---

**Issue Date:** 09/27/2023

**Wage Request Number:** 20230927-017

| Classification  | Effective Date | Base Wage | Health  | Pension | Supplemental Unemployment | Total Rate |
|---|----------------|-----------|---------|---------|---------------------------|------------|
| <b>Construction</b>   |                |           |         |         |                           |            |
| (2 AXLE) DRIVER - EQUIPMENT<br><i>TEAMSTERS JOINT COUNCIL NO. 10 ZONE B</i>     | 06/01/2023     | \$38.95   | \$14.57 | \$17.29 | \$0.00                    | \$70.81    |
|   | 12/01/2023     | \$38.95   | \$14.57 | \$18.67 | \$0.00                    | \$72.19    |
|   | 01/01/2024     | \$38.95   | \$15.07 | \$18.67 | \$0.00                    | \$72.69    |
|   | 06/01/2024     | \$39.95   | \$15.07 | \$18.67 | \$0.00                    | \$73.69    |
|   | 12/01/2024     | \$39.95   | \$15.07 | \$20.17 | \$0.00                    | \$75.19    |
|   | 01/01/2025     | \$39.95   | \$15.57 | \$20.17 | \$0.00                    | \$75.69    |
|   | 06/01/2025     | \$40.95   | \$15.57 | \$20.17 | \$0.00                    | \$76.69    |
|   | 12/01/2025     | \$40.95   | \$15.57 | \$21.78 | \$0.00                    | \$78.30    |
|   | 01/01/2026     | \$40.95   | \$16.17 | \$21.78 | \$0.00                    | \$78.90    |
|   | 06/01/2026     | \$41.95   | \$16.17 | \$21.78 | \$0.00                    | \$79.90    |
|   | 12/01/2026     | \$41.95   | \$16.17 | \$23.52 | \$0.00                    | \$81.64    |
|   | 01/01/2027     | \$41.95   | \$16.77 | \$23.52 | \$0.00                    | \$82.24    |
| (3 AXLE) DRIVER - EQUIPMENT<br><i>TEAMSTERS JOINT COUNCIL NO. 10 ZONE B</i>     | 06/01/2023     | \$39.02   | \$14.57 | \$17.29 | \$0.00                    | \$70.88    |
|   | 12/01/2023     | \$39.02   | \$14.57 | \$18.67 | \$0.00                    | \$72.26    |
|   | 01/01/2024     | \$39.02   | \$15.07 | \$18.67 | \$0.00                    | \$72.76    |
|   | 06/01/2024     | \$40.02   | \$15.07 | \$18.67 | \$0.00                    | \$73.76    |
|   | 12/01/2024     | \$40.02   | \$15.07 | \$20.17 | \$0.00                    | \$75.26    |
|   | 01/01/2025     | \$40.02   | \$15.57 | \$20.17 | \$0.00                    | \$75.76    |
|   | 06/01/2025     | \$41.02   | \$15.57 | \$20.17 | \$0.00                    | \$76.76    |
|   | 12/01/2025     | \$41.02   | \$15.57 | \$21.78 | \$0.00                    | \$78.37    |
|   | 01/01/2026     | \$41.02   | \$16.17 | \$21.78 | \$0.00                    | \$78.97    |
|   | 06/01/2026     | \$42.02   | \$16.17 | \$21.78 | \$0.00                    | \$79.97    |
|   | 12/01/2026     | \$42.02   | \$16.17 | \$23.52 | \$0.00                    | \$81.71    |
|   | 01/01/2027     | \$42.02   | \$16.77 | \$23.52 | \$0.00                    | \$82.31    |
| (4 & 5 AXLE) DRIVER - EQUIPMENT<br><i>TEAMSTERS JOINT COUNCIL NO. 10 ZONE B</i> | 06/01/2023     | \$39.14   | \$14.57 | \$17.29 | \$0.00                    | \$71.00    |
|   | 12/01/2023     | \$39.14   | \$14.57 | \$18.67 | \$0.00                    | \$72.38    |
|   | 01/01/2024     | \$39.14   | \$15.07 | \$18.67 | \$0.00                    | \$72.88    |
|   | 06/01/2024     | \$40.14   | \$15.07 | \$18.67 | \$0.00                    | \$73.88    |
|   | 12/01/2024     | \$40.14   | \$15.07 | \$20.17 | \$0.00                    | \$75.38    |
|   | 01/01/2025     | \$40.14   | \$15.57 | \$20.17 | \$0.00                    | \$75.88    |
|   | 06/01/2025     | \$41.14   | \$15.57 | \$20.17 | \$0.00                    | \$76.88    |
|   | 12/01/2025     | \$41.14   | \$15.57 | \$21.78 | \$0.00                    | \$78.49    |
|   | 01/01/2026     | \$41.14   | \$16.17 | \$21.78 | \$0.00                    | \$79.09    |
|   | 06/01/2026     | \$42.14   | \$16.17 | \$21.78 | \$0.00                    | \$80.09    |
|   | 12/01/2026     | \$42.14   | \$16.17 | \$23.52 | \$0.00                    | \$81.83    |
|   | 01/01/2027     | \$42.14   | \$16.77 | \$23.52 | \$0.00                    | \$82.43    |
| ADS/SUBMERSIBLE PILOT<br><i>PILE DRIVER LOCAL 56 (ZONE 2)</i>                   | 08/01/2020     | \$103.05  | \$9.40  | \$23.12 | \$0.00                    | \$135.57   |
| For apprentice rates see "Apprentice- PILE DRIVER"                              |                |           |         |         |                           |            |
| AIR TRACK OPERATOR<br><i>LABORERS - ZONE 2</i>                                  | 06/01/2023     | \$38.21   | \$9.40  | \$16.89 | \$0.00                    | \$64.50    |
|   | 12/01/2023     | \$39.11   | \$9.40  | \$16.89 | \$0.00                    | \$65.40    |
| For apprentice rates see "Apprentice- LABORER"                                  |                |           |         |         |                           |            |

| Classification  | Effective Date | Base Wage | Health  | Pension | Supplemental Unemployment | Total Rate |
|---|----------------|-----------|---------|---------|---------------------------|------------|
| AIR TRACK OPERATOR (HEAVY & HIGHWAY)<br><i>LABORERS - ZONE 2 (HEAVY &amp; HIGHWAY)</i>    | 06/01/2023     | \$38.21   | \$9.40  | \$16.89 | \$0.00                    | \$64.50    |
|   | 12/01/2023     | \$39.11   | \$9.40  | \$16.89 | \$0.00                    | \$65.40    |
|   | 06/01/2024     | \$40.44   | \$9.40  | \$16.89 | \$0.00                    | \$66.73    |
|   | 12/01/2024     | \$41.77   | \$9.40  | \$16.89 | \$0.00                    | \$68.06    |
|   | 06/01/2025     | \$43.16   | \$9.40  | \$16.89 | \$0.00                    | \$69.45    |
|   | 12/01/2025     | \$44.54   | \$9.40  | \$16.89 | \$0.00                    | \$70.83    |
|   | 06/01/2026     | \$45.98   | \$9.40  | \$16.89 | \$0.00                    | \$72.27    |
|   | 12/01/2026     | \$47.42   | \$9.40  | \$16.89 | \$0.00                    | \$73.71    |
| For apprentice rates see "Apprentice- LABORER (Heavy and Highway)                         |                |           |         |         |                           |            |
| ASBESTOS WORKER (PIPES & TANKS)<br><i>HEAT &amp; FROST INSULATORS LOCAL 6 (WORCESTER)</i> | 06/01/2023     | \$39.80   | \$14.50 | \$11.05 | \$0.00                    | \$65.35    |
|   | 12/01/2023     | \$40.80   | \$14.50 | \$11.05 | \$0.00                    | \$66.35    |
|   | 06/01/2024     | \$41.80   | \$14.50 | \$11.05 | \$0.00                    | \$67.35    |
|   | 12/01/2024     | \$42.80   | \$14.50 | \$11.05 | \$0.00                    | \$68.35    |
|   | 06/01/2025     | \$43.80   | \$14.50 | \$11.05 | \$0.00                    | \$69.35    |
|   | 12/01/2025     | \$44.80   | \$14.50 | \$11.05 | \$0.00                    | \$70.35    |
| ASPHALT RAKER<br><i>LABORERS - ZONE 2</i>   | 06/01/2023     | \$37.71   | \$9.40  | \$16.89 | \$0.00                    | \$64.00    |
|   | 12/01/2023     | \$38.61   | \$9.40  | \$16.89 | \$0.00                    | \$64.90    |
| For apprentice rates see "Apprentice- LABORER"  |                |           |         |         |                           |            |
| ASPHALT RAKER (HEAVY & HIGHWAY)<br><i>LABORERS - ZONE 2 (HEAVY &amp; HIGHWAY)</i>         | 06/01/2023     | \$37.71   | \$9.40  | \$16.89 | \$0.00                    | \$64.00    |
|   | 12/01/2023     | \$38.61   | \$9.40  | \$16.89 | \$0.00                    | \$64.90    |
|   | 06/01/2024     | \$39.94   | \$9.40  | \$16.89 | \$0.00                    | \$66.23    |
|   | 12/01/2024     | \$41.27   | \$9.40  | \$16.89 | \$0.00                    | \$67.56    |
|   | 06/01/2025     | \$42.66   | \$9.40  | \$16.89 | \$0.00                    | \$68.95    |
|   | 12/01/2025     | \$44.04   | \$9.40  | \$16.89 | \$0.00                    | \$70.33    |
|   | 06/01/2026     | \$45.48   | \$9.40  | \$16.89 | \$0.00                    | \$71.77    |
|   | 12/01/2026     | \$46.92   | \$9.40  | \$16.89 | \$0.00                    | \$73.21    |
| For apprentice rates see "Apprentice- LABORER (Heavy and Highway)                         |                |           |         |         |                           |            |
| ASPHALT/CONCRETE/CRUSHER PLANT-ON SITE<br><i>OPERATING ENGINEERS LOCAL 4</i>              | 06/01/2023     | \$54.28   | \$14.75 | \$16.15 | \$0.00                    | \$85.18    |
|   | 12/01/2023     | \$55.53   | \$14.75 | \$16.15 | \$0.00                    | \$86.43    |
|   | 06/01/2024     | \$56.83   | \$14.75 | \$16.15 | \$0.00                    | \$87.73    |
|   | 12/01/2024     | \$58.28   | \$14.75 | \$16.15 | \$0.00                    | \$89.18    |
|   | 06/01/2025     | \$59.58   | \$14.75 | \$16.15 | \$0.00                    | \$90.48    |
|   | 12/01/2025     | \$61.03   | \$14.75 | \$16.15 | \$0.00                    | \$91.93    |
|   | 06/01/2026     | \$62.33   | \$14.75 | \$16.15 | \$0.00                    | \$93.23    |
|   | 12/01/2026     | \$63.78   | \$14.75 | \$16.15 | \$0.00                    | \$94.68    |
| For apprentice rates see "Apprentice- OPERATING ENGINEERS"                                |                |           |         |         |                           |            |
| BACKHOE/FRONT-END LOADER<br><i>OPERATING ENGINEERS LOCAL 4</i>                            | 06/01/2023     | \$54.28   | \$14.75 | \$16.15 | \$0.00                    | \$85.18    |
|   | 12/01/2023     | \$55.53   | \$14.75 | \$16.15 | \$0.00                    | \$86.43    |
|   | 06/01/2024     | \$56.83   | \$14.75 | \$16.15 | \$0.00                    | \$87.73    |
|   | 12/01/2024     | \$58.28   | \$14.75 | \$16.15 | \$0.00                    | \$89.18    |
|   | 06/01/2025     | \$59.58   | \$14.75 | \$16.15 | \$0.00                    | \$90.48    |
|   | 12/01/2025     | \$61.03   | \$14.75 | \$16.15 | \$0.00                    | \$91.93    |
|   | 06/01/2026     | \$62.33   | \$14.75 | \$16.15 | \$0.00                    | \$93.23    |
|   | 12/01/2026     | \$63.78   | \$14.75 | \$16.15 | \$0.00                    | \$94.68    |
| For apprentice rates see "Apprentice- OPERATING ENGINEERS"                                |                |           |         |         |                           |            |

| Classification  | Effective Date | Base Wage | Health  | Pension | Supplemental Unemployment | Total Rate |
|---|----------------|-----------|---------|---------|---------------------------|------------|
| BARCO-TYPE JUMPING TAMPER<br><i>LABORERS - ZONE 2</i>   | 06/01/2023     | \$37.71   | \$9.40  | \$16.89 | \$0.00                    | \$64.00    |
|   | 12/01/2023     | \$38.61   | \$9.40  | \$16.89 | \$0.00                    | \$64.90    |
| For apprentice rates see "Apprentice- LABORER"  |                |           |         |         |                           |            |
| BLOCK PAVER, RAMMER / CURB SETTER<br><i>LABORERS - ZONE 2</i>   | 06/01/2023     | \$38.21   | \$9.40  | \$16.89 | \$0.00                    | \$64.50    |
|   | 12/01/2023     | \$39.11   | \$9.40  | \$16.89 | \$0.00                    | \$65.40    |
| For apprentice rates see "Apprentice- LABORER"  |                |           |         |         |                           |            |
| BLOCK PAVER, RAMMER / CURB SETTER (HEAVY & HIGHWAY)<br><i>LABORERS - ZONE 2 (HEAVY &amp; HIGHWAY)</i> | 06/01/2023     | \$38.21   | \$9.40  | \$16.89 | \$0.00                    | \$64.50    |
|   | 12/01/2023     | \$39.11   | \$9.40  | \$16.89 | \$0.00                    | \$65.40    |
|   | 06/01/2024     | \$40.44   | \$9.40  | \$16.89 | \$0.00                    | \$66.73    |
|   | 12/01/2024     | \$41.77   | \$9.40  | \$16.89 | \$0.00                    | \$68.06    |
|   | 06/01/2025     | \$43.16   | \$9.40  | \$16.89 | \$0.00                    | \$69.45    |
|   | 12/01/2025     | \$44.54   | \$9.40  | \$16.89 | \$0.00                    | \$70.83    |
|   | 06/01/2026     | \$45.98   | \$9.40  | \$16.89 | \$0.00                    | \$72.27    |
| 12/01/2026  | \$47.42        | \$9.40    | \$16.89 | \$0.00  | \$73.71                   |            |
| For apprentice rates see "Apprentice- LABORER (Heavy and Highway)"                                    |                |           |         |         |                           |            |
| BOILER MAKER<br><i>BOILERMAKERS LOCAL 29</i>  | 01/01/2023     | \$47.37   | \$7.07  | \$20.31 | \$0.00                    | \$74.75    |
|   | 01/01/2024     | \$48.12   | \$7.07  | \$20.60 | \$0.00                    | \$75.79    |

**Apprentice - BOILERMAKER - Local 29**

**Effective Date - 01/01/2023**

| Step | percent | Apprentice Base Wage | Health | Pension | Supplemental Unemployment | Total Rate |
|------|---------|----------------------|--------|---------|---------------------------|------------|
| 1    | 65      | \$30.79              | \$7.07 | \$13.22 | \$0.00                    | \$51.08    |
| 2    | 65      | \$30.79              | \$7.07 | \$13.22 | \$0.00                    | \$51.08    |
| 3    | 70      | \$33.16              | \$7.07 | \$14.23 | \$0.00                    | \$54.46    |
| 4    | 75      | \$35.53              | \$7.07 | \$15.24 | \$0.00                    | \$57.84    |
| 5    | 80      | \$37.90              | \$7.07 | \$16.25 | \$0.00                    | \$61.22    |
| 6    | 85      | \$40.26              | \$7.07 | \$17.28 | \$0.00                    | \$64.61    |
| 7    | 90      | \$42.63              | \$7.07 | \$18.28 | \$0.00                    | \$67.98    |
| 8    | 95      | \$45.00              | \$7.07 | \$19.32 | \$0.00                    | \$71.39    |

**Effective Date - 01/01/2024**

| Step | percent | Apprentice Base Wage | Health | Pension | Supplemental Unemployment | Total Rate |
|------|---------|----------------------|--------|---------|---------------------------|------------|
| 1    | 65      | \$31.28              | \$7.07 | \$13.22 | \$0.00                    | \$51.57    |
| 2    | 65      | \$31.28              | \$7.07 | \$13.22 | \$0.00                    | \$51.57    |
| 3    | 70      | \$33.68              | \$7.07 | \$14.23 | \$0.00                    | \$54.98    |
| 4    | 75      | \$36.09              | \$7.07 | \$15.24 | \$0.00                    | \$58.40    |
| 5    | 80      | \$38.50              | \$7.07 | \$16.25 | \$0.00                    | \$61.82    |
| 6    | 85      | \$40.90              | \$7.07 | \$17.28 | \$0.00                    | \$65.25    |
| 7    | 90      | \$43.31              | \$7.07 | \$18.28 | \$0.00                    | \$68.66    |
| 8    | 95      | \$45.71              | \$7.07 | \$19.32 | \$0.00                    | \$72.10    |

**Notes:**

**Apprentice to Journeyworker Ratio:1:4**

| Classification  | Effective Date | Base Wage | Health  | Pension | Supplemental Unemployment | Total Rate |
|---|----------------|-----------|---------|---------|---------------------------|------------|
| BRICK/STONE/ARTIFICIAL MASONRY (INCL. MASONRY WATERPROOFING)<br><i>BRICKLAYERS LOCAL 3 (LOWELL)</i> | 08/01/2023     | \$60.26   | \$11.49 | \$21.65 | \$0.00                    | \$93.40    |
|   | 02/01/2024     | \$61.51   | \$11.49 | \$21.65 | \$0.00                    | \$94.65    |
|   | 08/01/2024     | \$63.61   | \$11.49 | \$21.65 | \$0.00                    | \$96.75    |
|   | 02/01/2025     | \$64.91   | \$11.49 | \$21.65 | \$0.00                    | \$98.05    |
|   | 08/01/2025     | \$67.06   | \$11.49 | \$21.65 | \$0.00                    | \$100.20   |
|   | 02/01/2026     | \$68.41   | \$11.49 | \$21.65 | \$0.00                    | \$101.55   |
|   | 08/01/2026     | \$70.61   | \$11.49 | \$21.65 | \$0.00                    | \$103.75   |
|   | 02/01/2027     | \$72.01   | \$11.49 | \$21.65 | \$0.00                    | \$105.15   |

**Apprentice - BRICK/PLASTER/CEMENT MASON - Local 3 Lowell**

**Effective Date - 08/01/2023**

| Step | percent | Apprentice Base Wage | Health  | Pension | Supplemental Unemployment | Total Rate |
|------|---------|----------------------|---------|---------|---------------------------|------------|
| 1    | 50      | \$30.13              | \$11.49 | \$21.65 | \$0.00                    | \$63.27    |
| 2    | 60      | \$36.16              | \$11.49 | \$21.65 | \$0.00                    | \$69.30    |
| 3    | 70      | \$42.18              | \$11.49 | \$21.65 | \$0.00                    | \$75.32    |
| 4    | 80      | \$48.21              | \$11.49 | \$21.65 | \$0.00                    | \$81.35    |
| 5    | 90      | \$54.23              | \$11.49 | \$21.65 | \$0.00                    | \$87.37    |

**Effective Date - 02/01/2024**

| Step | percent | Apprentice Base Wage | Health  | Pension | Supplemental Unemployment | Total Rate |
|------|---------|----------------------|---------|---------|---------------------------|------------|
| 1    | 50      | \$30.76              | \$11.49 | \$21.65 | \$0.00                    | \$63.90    |
| 2    | 60      | \$36.91              | \$11.49 | \$21.65 | \$0.00                    | \$70.05    |
| 3    | 70      | \$43.06              | \$11.49 | \$21.65 | \$0.00                    | \$76.20    |
| 4    | 80      | \$49.21              | \$11.49 | \$21.65 | \$0.00                    | \$82.35    |
| 5    | 90      | \$55.36              | \$11.49 | \$21.65 | \$0.00                    | \$88.50    |

**Notes:**

**Apprentice to Journeyworker Ratio:1:5**

|  |            |         |         |         |        |         |
|--|------------|---------|---------|---------|--------|---------|
| BULLDOZER/GRADER/SCRAPER<br><i>OPERATING ENGINEERS LOCAL 4</i> | 06/01/2023 | \$53.69 | \$14.75 | \$16.15 | \$0.00 | \$84.59 |
|  | 12/01/2023 | \$54.93 | \$14.75 | \$16.15 | \$0.00 | \$85.83 |
|  | 06/01/2024 | \$56.21 | \$14.75 | \$16.15 | \$0.00 | \$87.11 |
|  | 12/01/2024 | \$57.65 | \$14.75 | \$16.15 | \$0.00 | \$88.55 |
|  | 06/01/2025 | \$58.93 | \$14.75 | \$16.15 | \$0.00 | \$89.83 |
|  | 12/01/2025 | \$60.37 | \$14.75 | \$16.15 | \$0.00 | \$91.27 |
|  | 06/01/2026 | \$61.65 | \$14.75 | \$16.15 | \$0.00 | \$92.55 |
|  | 12/01/2026 | \$63.09 | \$14.75 | \$16.15 | \$0.00 | \$93.99 |

For apprentice rates see "Apprentice- OPERATING ENGINEERS"

| Classification   | Effective Date | Base Wage | Health | Pension | Supplemental Unemployment | Total Rate |
|--|----------------|-----------|--------|---------|---------------------------|------------|
| CAISSON & UNDERPINNING BOTTOM MAN<br><i>LABORERS - FOUNDATION AND MARINE</i> | 06/01/2023     | \$44.73   | \$9.40 | \$17.97 | \$0.00                    | \$72.10    |
|  | 12/01/2023     | \$45.98   | \$9.40 | \$17.97 | \$0.00                    | \$73.35    |
|  | 06/01/2024     | \$47.46   | \$9.40 | \$17.97 | \$0.00                    | \$74.83    |
|  | 12/01/2024     | \$48.93   | \$9.40 | \$17.97 | \$0.00                    | \$76.30    |
|  | 06/01/2025     | \$50.43   | \$9.40 | \$17.97 | \$0.00                    | \$77.80    |
|  | 12/01/2025     | \$51.93   | \$9.40 | \$17.97 | \$0.00                    | \$79.30    |
|  | 06/01/2026     | \$53.48   | \$9.40 | \$17.97 | \$0.00                    | \$80.85    |
|  | 12/01/2026     | \$54.98   | \$9.40 | \$17.97 | \$0.00                    | \$82.35    |
| For apprentice rates see "Apprentice- LABORER"                               |                |           |        |         |                           |            |
| CAISSON & UNDERPINNING LABORER<br><i>LABORERS - FOUNDATION AND MARINE</i>    | 06/01/2023     | \$43.58   | \$9.40 | \$17.97 | \$0.00                    | \$70.95    |
|  | 12/01/2023     | \$44.83   | \$9.40 | \$17.97 | \$0.00                    | \$72.20    |
|  | 06/01/2024     | \$46.31   | \$9.40 | \$17.97 | \$0.00                    | \$73.68    |
|  | 12/01/2024     | \$47.78   | \$9.40 | \$17.97 | \$0.00                    | \$75.15    |
|  | 06/01/2025     | \$49.28   | \$9.40 | \$17.97 | \$0.00                    | \$76.65    |
|  | 12/01/2025     | \$50.78   | \$9.40 | \$17.97 | \$0.00                    | \$78.15    |
|  | 06/01/2026     | \$52.33   | \$9.40 | \$17.97 | \$0.00                    | \$79.70    |
|  | 12/01/2026     | \$53.83   | \$9.40 | \$17.97 | \$0.00                    | \$81.20    |
| For apprentice rates see "Apprentice- LABORER"                               |                |           |        |         |                           |            |
| CAISSON & UNDERPINNING TOP MAN<br><i>LABORERS - FOUNDATION AND MARINE</i>    | 06/01/2023     | \$43.58   | \$9.40 | \$17.97 | \$0.00                    | \$70.95    |
|  | 12/01/2023     | \$44.83   | \$9.40 | \$17.97 | \$0.00                    | \$72.20    |
|  | 06/01/2024     | \$46.31   | \$9.40 | \$17.97 | \$0.00                    | \$73.68    |
|  | 12/01/2024     | \$47.78   | \$9.40 | \$17.97 | \$0.00                    | \$75.15    |
|  | 06/01/2025     | \$49.28   | \$9.40 | \$17.97 | \$0.00                    | \$76.65    |
|  | 12/01/2025     | \$50.78   | \$9.40 | \$17.97 | \$0.00                    | \$78.15    |
|  | 06/01/2026     | \$52.33   | \$9.40 | \$17.97 | \$0.00                    | \$79.70    |
|  | 12/01/2026     | \$53.83   | \$9.40 | \$17.97 | \$0.00                    | \$81.20    |
| For apprentice rates see "Apprentice- LABORER"                               |                |           |        |         |                           |            |
| CARBIDE CORE DRILL OPERATOR<br><i>LABORERS - ZONE 2</i>                      | 06/01/2023     | \$37.71   | \$9.40 | \$16.89 | \$0.00                    | \$64.00    |
|  | 12/01/2023     | \$38.61   | \$9.40 | \$16.89 | \$0.00                    | \$64.90    |
| For apprentice rates see "Apprentice- LABORER"                               |                |           |        |         |                           |            |
| CARPENTER<br><i>CARPENTERS -ZONE 2 (Eastern Massachusetts)</i>               | 03/01/2023     | \$45.12   | \$9.33 | \$19.97 | \$0.00                    | \$74.42    |



|                       |                       |                  |               |                |                                  |                   |
|-----------------------|-----------------------|------------------|---------------|----------------|----------------------------------|-------------------|
| <b>Classification</b> | <b>Effective Date</b> | <b>Base Wage</b> | <b>Health</b> | <b>Pension</b> | <b>Supplemental Unemployment</b> | <b>Total Rate</b> |
|-----------------------|-----------------------|------------------|---------------|----------------|----------------------------------|-------------------|

**Apprentice - CARPENTER - Zone 2 Eastern MA**

**Effective Date - 03/01/2023**

| Step | percent | Apprentice Base Wage | Health | Pension | Supplemental Unemployment | Total Rate |
|------|---------|----------------------|--------|---------|---------------------------|------------|
| 1    | 50      | \$22.56              | \$9.33 | \$1.73  | \$0.00                    | \$33.62    |
| 2    | 60      | \$27.07              | \$9.33 | \$1.73  | \$0.00                    | \$38.13    |
| 3    | 70      | \$31.58              | \$9.33 | \$14.78 | \$0.00                    | \$55.69    |
| 4    | 75      | \$33.84              | \$9.33 | \$14.78 | \$0.00                    | \$57.95    |
| 5    | 80      | \$36.10              | \$9.33 | \$16.51 | \$0.00                    | \$61.94    |
| 6    | 80      | \$36.10              | \$9.33 | \$16.51 | \$0.00                    | \$61.94    |
| 7    | 90      | \$40.61              | \$9.33 | \$18.24 | \$0.00                    | \$68.18    |
| 8    | 90      | \$40.61              | \$9.33 | \$18.24 | \$0.00                    | \$68.18    |

**Notes:**  
 % Indentured After 10/1/17; 45/45/55/55/70/70/80/80  
 Step 1&2 \$30.71/ 3&4 \$36.93/ 5&6 \$56.82/ 7&8 \$63.06

**Apprentice to Journeyworker Ratio:1:5**

|   |            |         |        |        |        |         |
|---|------------|---------|--------|--------|--------|---------|
| CARPENTER WOOD FRAME<br><i>CARPENTERS-ZONE 3 (Wood Frame)</i> | 04/01/2023 | \$24.16 | \$7.21 | \$4.80 | \$0.00 | \$36.17 |
|---|------------|---------|--------|--------|--------|---------|

All Aspects of New Wood Frame Work

**Apprentice - CARPENTER (Wood Frame) - Zone 3**

**Effective Date - 04/01/2023**

| Step | percent | Apprentice Base Wage | Health | Pension | Supplemental Unemployment | Total Rate |
|------|---------|----------------------|--------|---------|---------------------------|------------|
| 1    | 60      | \$14.50              | \$7.21 | \$0.00  | \$0.00                    | \$21.71    |
| 2    | 60      | \$14.50              | \$7.21 | \$0.00  | \$0.00                    | \$21.71    |
| 3    | 65      | \$15.70              | \$7.21 | \$0.00  | \$0.00                    | \$22.91    |
| 4    | 70      | \$16.91              | \$7.21 | \$0.00  | \$0.00                    | \$24.12    |
| 5    | 75      | \$18.12              | \$7.21 | \$3.80  | \$0.00                    | \$29.13    |
| 6    | 80      | \$19.33              | \$7.21 | \$3.80  | \$0.00                    | \$30.34    |
| 7    | 85      | \$20.54              | \$7.21 | \$3.80  | \$0.00                    | \$31.55    |
| 8    | 90      | \$21.74              | \$7.21 | \$3.80  | \$0.00                    | \$32.75    |

**Notes:**  
 % Indentured After 10/1/17; 45/45/55/55/70/70/80/80  
 Step 1&2 \$17.86/ 3&4 \$20.22/ 5&6 \$27.57/ 7&8 \$29.94

**Apprentice to Journeyworker Ratio:1:5**

|  |            |         |         |         |        |         |
|--|------------|---------|---------|---------|--------|---------|
| CEMENT MASONRY/PLASTERING<br><i>BRICKLAYERS LOCAL 3 (LOWELL)</i> | 07/01/2023 | \$48.19 | \$13.00 | \$23.57 | \$1.30 | \$86.06 |
|  | 01/01/2024 | \$49.33 | \$13.00 | \$23.57 | \$1.30 | \$87.20 |

Classification

Effective Date   Base Wage   Health   Pension   Supplemental Unemployment   Total Rate

**Apprentice - CEMENT MASONRY/PLASTERING - Lowell**

**Effective Date - 07/01/2023**

| Step | percent | Apprentice Base Wage | Health  | Pension | Supplemental Unemployment | Total Rate |
|------|---------|----------------------|---------|---------|---------------------------|------------|
| 1    | 50      | \$24.10              | \$13.00 | \$15.93 | \$0.00                    | \$53.03    |
| 2    | 60      | \$28.91              | \$13.00 | \$18.57 | \$1.30                    | \$61.78    |
| 3    | 65      | \$31.32              | \$13.00 | \$19.57 | \$1.30                    | \$65.19    |
| 4    | 70      | \$33.73              | \$13.00 | \$20.57 | \$1.30                    | \$68.60    |
| 5    | 75      | \$36.14              | \$13.00 | \$21.57 | \$1.30                    | \$72.01    |
| 6    | 80      | \$38.55              | \$13.00 | \$22.57 | \$1.30                    | \$75.42    |
| 7    | 90      | \$43.37              | \$13.00 | \$23.67 | \$1.30                    | \$81.34    |

**Effective Date - 01/01/2024**

| Step | percent | Apprentice Base Wage | Health  | Pension | Supplemental Unemployment | Total Rate |
|------|---------|----------------------|---------|---------|---------------------------|------------|
| 1    | 50      | \$24.67              | \$13.00 | \$15.93 | \$0.00                    | \$53.60    |
| 2    | 60      | \$29.60              | \$13.00 | \$18.57 | \$1.30                    | \$62.47    |
| 3    | 65      | \$32.06              | \$13.00 | \$19.57 | \$1.30                    | \$65.93    |
| 4    | 70      | \$34.53              | \$13.00 | \$20.57 | \$1.30                    | \$69.40    |
| 5    | 75      | \$37.00              | \$13.00 | \$21.57 | \$1.30                    | \$72.87    |
| 6    | 80      | \$39.46              | \$13.00 | \$22.57 | \$1.30                    | \$76.33    |
| 7    | 90      | \$44.40              | \$13.00 | \$23.57 | \$1.30                    | \$82.27    |

**Notes:**

Steps 3,4 are 500 hrs. All other steps are 1,000 hrs.

**Apprentice to Journeyworker Ratio:1:3**

|  |            |         |        |         |        |         |
|--|------------|---------|--------|---------|--------|---------|
| CHAIN SAW OPERATOR<br><i>LABORERS - ZONE 2</i> | 06/01/2023 | \$37.71 | \$9.40 | \$16.89 | \$0.00 | \$64.00 |
|  | 12/01/2023 | \$38.61 | \$9.40 | \$16.89 | \$0.00 | \$64.90 |

For apprentice rates see "Apprentice- LABORER"

|   |            |         |         |         |        |         |
|---|------------|---------|---------|---------|--------|---------|
| CLAM SHELLS/SLURRY BUCKETS/HEADING MACHINES<br><i>OPERATING ENGINEERS LOCAL 4</i> | 06/01/2023 | \$55.35 | \$14.75 | \$16.15 | \$0.00 | \$86.25 |
|   | 12/01/2023 | \$56.63 | \$14.75 | \$16.15 | \$0.00 | \$87.53 |
|   | 06/01/2024 | \$57.95 | \$14.75 | \$16.15 | \$0.00 | \$88.85 |
|   | 12/01/2024 | \$59.43 | \$14.75 | \$16.15 | \$0.00 | \$90.33 |
|   | 06/01/2025 | \$60.76 | \$14.75 | \$16.15 | \$0.00 | \$91.66 |
|   | 12/01/2025 | \$62.23 | \$14.75 | \$16.15 | \$0.00 | \$93.13 |
|   | 06/01/2026 | \$63.56 | \$14.75 | \$16.15 | \$0.00 | \$94.46 |
|   | 12/01/2026 | \$65.04 | \$14.75 | \$16.15 | \$0.00 | \$95.94 |

For apprentice rates see "Apprentice- OPERATING ENGINEERS"

|   |            |         |         |         |        |         |
|---|------------|---------|---------|---------|--------|---------|
| COMPRESSOR OPERATOR<br><i>OPERATING ENGINEERS LOCAL 4</i> | 06/01/2023 | \$35.30 | \$14.75 | \$16.15 | \$0.00 | \$66.20 |
|   | 12/01/2023 | \$36.12 | \$14.75 | \$16.15 | \$0.00 | \$67.02 |
|   | 06/01/2024 | \$36.97 | \$14.75 | \$16.15 | \$0.00 | \$67.87 |
|   | 12/01/2024 | \$37.92 | \$14.75 | \$16.15 | \$0.00 | \$68.82 |
|   | 06/01/2025 | \$38.77 | \$14.75 | \$16.15 | \$0.00 | \$69.67 |
|   | 12/01/2025 | \$39.72 | \$14.75 | \$16.15 | \$0.00 | \$70.62 |
|   | 06/01/2026 | \$40.58 | \$14.75 | \$16.15 | \$0.00 | \$71.48 |
|   | 12/01/2026 | \$41.53 | \$14.75 | \$16.15 | \$0.00 | \$72.43 |

| Classification   | Effective Date | Base Wage | Health | Pension | Supplemental Unemployment | Total Rate |
|--|----------------|-----------|--------|---------|---------------------------|------------|
| For apprentice rates see "Apprentice- OPERATING ENGINEERS" |                |           |        |         |                           |            |
| DELEADER (BRIDGE)<br>PAINTERS LOCAL 35 - ZONE 2            | 07/01/2023     | \$55.51   | \$9.65 | \$23.70 | \$0.00                    | \$88.86    |
|  | 01/01/2024     | \$56.06   | \$9.95 | \$23.95 | \$0.00                    | \$89.96    |
|  | 07/01/2024     | \$57.26   | \$9.95 | \$23.95 | \$0.00                    | \$91.16    |
|  | 01/01/2025     | \$58.46   | \$9.95 | \$23.95 | \$0.00                    | \$92.36    |

**Apprentice - PAINTER Local 35 - BRIDGES/TANKS**

**Effective Date - 07/01/2023**

| Step | percent | Apprentice Base Wage | Health | Pension | Supplemental Unemployment | Total Rate |
|------|---------|----------------------|--------|---------|---------------------------|------------|
| 1    | 50      | \$27.76              | \$9.65 | \$0.00  | \$0.00                    | \$37.41    |
| 2    | 55      | \$30.53              | \$9.65 | \$6.55  | \$0.00                    | \$46.73    |
| 3    | 60      | \$33.31              | \$9.65 | \$7.14  | \$0.00                    | \$50.10    |
| 4    | 65      | \$36.08              | \$9.65 | \$7.74  | \$0.00                    | \$53.47    |
| 5    | 70      | \$38.86              | \$9.65 | \$20.13 | \$0.00                    | \$68.64    |
| 6    | 75      | \$41.63              | \$9.65 | \$20.73 | \$0.00                    | \$72.01    |
| 7    | 80      | \$44.41              | \$9.65 | \$21.32 | \$0.00                    | \$75.38    |
| 8    | 90      | \$49.96              | \$9.65 | \$22.51 | \$0.00                    | \$82.12    |

**Effective Date - 01/01/2024**

| Step | percent | Apprentice Base Wage | Health | Pension | Supplemental Unemployment | Total Rate |
|------|---------|----------------------|--------|---------|---------------------------|------------|
| 1    | 50      | \$28.03              | \$9.95 | \$0.00  | \$0.00                    | \$37.98    |
| 2    | 55      | \$30.83              | \$9.95 | \$6.66  | \$0.00                    | \$47.44    |
| 3    | 60      | \$33.64              | \$9.95 | \$7.26  | \$0.00                    | \$50.85    |
| 4    | 65      | \$36.44              | \$9.95 | \$7.87  | \$0.00                    | \$54.26    |
| 5    | 70      | \$39.24              | \$9.95 | \$20.32 | \$0.00                    | \$69.51    |
| 6    | 75      | \$42.05              | \$9.95 | \$20.93 | \$0.00                    | \$72.93    |
| 7    | 80      | \$44.85              | \$9.95 | \$21.53 | \$0.00                    | \$76.33    |
| 8    | 90      | \$50.45              | \$9.95 | \$22.74 | \$0.00                    | \$83.14    |

**Notes:**

Steps are 750 hrs.

**Apprentice to Journeyworker Ratio:1:1**

|   |            |         |        |         |        |         |
|---|------------|---------|--------|---------|--------|---------|
| DEMO: ADZEMAN<br>LABORERS - ZONE 2                        | 06/01/2023 | \$43.73 | \$9.40 | \$17.82 | \$0.00 | \$70.95 |
|   | 12/01/2023 | \$44.98 | \$9.40 | \$17.82 | \$0.00 | \$72.20 |
| For apprentice rates see "Apprentice- LABORER"            |            |         |        |         |        |         |
| DEMO: BACKHOE/LOADER/HAMMER OPERATOR<br>LABORERS - ZONE 2 | 06/01/2023 | \$44.73 | \$9.40 | \$17.82 | \$0.00 | \$71.95 |
|   | 12/01/2023 | \$45.98 | \$9.40 | \$17.82 | \$0.00 | \$73.20 |
| For apprentice rates see "Apprentice- LABORER"            |            |         |        |         |        |         |
| DEMO: BURNERS<br>LABORERS - ZONE 2                        | 06/01/2023 | \$44.48 | \$9.40 | \$17.82 | \$0.00 | \$71.70 |
|   | 12/01/2023 | \$45.73 | \$9.40 | \$17.82 | \$0.00 | \$72.95 |
| For apprentice rates see "Apprentice- LABORER"            |            |         |        |         |        |         |
| DEMO: CONCRETE CUTTER/SAWYER<br>LABORERS - ZONE 2         | 06/01/2023 | \$44.73 | \$9.40 | \$17.82 | \$0.00 | \$71.95 |
|   | 12/01/2023 | \$45.98 | \$9.40 | \$17.82 | \$0.00 | \$73.20 |
| For apprentice rates see "Apprentice- LABORER"            |            |         |        |         |        |         |

| Classification   | Effective Date | Base Wage | Health  | Pension | Supplemental Unemployment | Total Rate |
|--|----------------|-----------|---------|---------|---------------------------|------------|
| DEMO: JACKHAMMER OPERATOR<br><i>LABORERS - ZONE 2</i>                    | 06/01/2023     | \$44.48   | \$9.40  | \$17.82 | \$0.00                    | \$71.70    |
|  | 12/01/2023     | \$45.73   | \$9.40  | \$17.82 | \$0.00                    | \$72.95    |
| For apprentice rates see "Apprentice- LABORER"                           |                |           |         |         |                           |            |
| DEMO: WRECKING LABORER<br><i>LABORERS - ZONE 2</i>                       | 06/01/2023     | \$43.73   | \$9.40  | \$17.82 | \$0.00                    | \$70.95    |
|  | 12/01/2023     | \$44.98   | \$9.40  | \$17.82 | \$0.00                    | \$72.20    |
| For apprentice rates see "Apprentice- LABORER"                           |                |           |         |         |                           |            |
| DIRECTIONAL DRILL MACHINE OPERATOR<br><i>OPERATING ENGINEERS LOCAL 4</i> | 06/01/2023     | \$53.69   | \$14.75 | \$16.15 | \$0.00                    | \$84.59    |
|  | 12/01/2023     | \$54.93   | \$14.75 | \$16.15 | \$0.00                    | \$85.83    |
|  | 06/01/2024     | \$56.21   | \$14.75 | \$16.15 | \$0.00                    | \$87.11    |
|  | 12/01/2024     | \$57.65   | \$14.75 | \$16.15 | \$0.00                    | \$88.55    |
|  | 06/01/2025     | \$58.93   | \$14.75 | \$16.15 | \$0.00                    | \$89.83    |
|  | 12/01/2025     | \$60.37   | \$14.75 | \$16.15 | \$0.00                    | \$91.27    |
|  | 06/01/2026     | \$61.65   | \$14.75 | \$16.15 | \$0.00                    | \$92.55    |
|  | 12/01/2026     | \$63.09   | \$14.75 | \$16.15 | \$0.00                    | \$93.99    |
| For apprentice rates see "Apprentice- OPERATING ENGINEERS"               |                |           |         |         |                           |            |
| DIVER<br><i>PILE DRIVER LOCAL 56 (ZONE 2)</i>                            | 08/01/2020     | \$68.70   | \$9.40  | \$23.12 | \$0.00                    | \$101.22   |
| For apprentice rates see "Apprentice- PILE DRIVER"                       |                |           |         |         |                           |            |
| DIVER TENDER<br><i>PILE DRIVER LOCAL 56 (ZONE 2)</i>                     | 08/01/2020     | \$49.07   | \$9.40  | \$23.12 | \$0.00                    | \$81.59    |
| For apprentice rates see "Apprentice- PILE DRIVER"                       |                |           |         |         |                           |            |
| DIVER TENDER (EFFLUENT)<br><i>PILE DRIVER LOCAL 56 (ZONE 2)</i>          | 08/01/2020     | \$73.60   | \$9.40  | \$23.12 | \$0.00                    | \$106.12   |
| For apprentice rates see "Apprentice- PILE DRIVER"                       |                |           |         |         |                           |            |
| DIVER/SLURRY (EFFLUENT)<br><i>PILE DRIVER LOCAL 56 (ZONE 2)</i>          | 08/01/2020     | \$103.05  | \$9.40  | \$23.12 | \$0.00                    | \$135.57   |
| For apprentice rates see "Apprentice- PILE DRIVER"                       |                |           |         |         |                           |            |
| DRAWBRIDGE OPERATOR (Construction)<br><i>DRAWBRIDGE - SEIU LOCAL 888</i> | 07/01/2020     | \$26.77   | \$6.67  | \$3.93  | \$0.16                    | \$37.53    |
| ELECTRICIAN<br><i>ELECTRICIANS LOCAL 96</i>                              | 09/04/2022     | \$45.59   | \$12.20 | \$17.50 | \$0.00                    | \$75.29    |

**Apprentice - ELECTRICIAN - Local 96**

**Effective Date - 09/04/2022**

| Step | percent | Apprentice Base Wage | Health  | Pension | Supplemental Unemployment | Total Rate |
|------|---------|----------------------|---------|---------|---------------------------|------------|
| 1    | 40      | \$18.24              | \$12.20 | \$0.55  | \$0.00                    | \$30.99    |
| 2    | 43      | \$19.60              | \$12.20 | \$0.59  | \$0.00                    | \$32.39    |
| 3    | 48      | \$21.88              | \$12.20 | \$14.18 | \$0.00                    | \$48.26    |
| 4    | 55      | \$25.07              | \$12.20 | \$14.63 | \$0.00                    | \$51.90    |
| 5    | 65      | \$29.63              | \$12.20 | \$15.27 | \$0.00                    | \$57.10    |
| 6    | 80      | \$36.47              | \$12.20 | \$16.22 | \$0.00                    | \$64.89    |

**Notes:**

Steps 1-2 are 1000 hrs; Steps 3-6 are 1500 hrs.

**Apprentice to Journeyworker Ratio:2:3\*\*\***

| Classification  | Effective Date | Base Wage | Health  | Pension | Supplemental Unemployment | Total Rate |
|---|----------------|-----------|---------|---------|---------------------------|------------|
| ELEVATOR CONSTRUCTOR<br><i>ELEVATOR CONSTRUCTORS LOCAL 41</i> | 01/01/2023     | \$61.13   | \$16.08 | \$20.56 | \$0.00                    | \$97.77    |
|   | 01/01/2024     | \$61.98   | \$16.18 | \$20.96 | \$0.00                    | \$99.12    |
|   | 01/01/2025     | \$62.83   | \$16.28 | \$21.36 | \$0.00                    | \$100.47   |
|   | 01/01/2026     | \$63.68   | \$16.38 | \$21.76 | \$0.00                    | \$101.82   |
|   | 01/01/2027     | \$64.53   | \$16.48 | \$22.16 | \$0.00                    | \$103.17   |

**Apprentice - ELEVATOR CONSTRUCTOR - Local 41**

**Effective Date - 01/01/2023**

| Step | percent | Apprentice Base Wage | Health  | Pension | Supplemental Unemployment | Total Rate |
|------|---------|----------------------|---------|---------|---------------------------|------------|
| 1    | 50      | \$30.57              | \$16.08 | \$0.00  | \$0.00                    | \$46.65    |
| 2    | 55      | \$33.62              | \$16.08 | \$20.56 | \$0.00                    | \$70.26    |
| 3    | 65      | \$39.73              | \$16.08 | \$20.56 | \$0.00                    | \$76.37    |
| 4    | 70      | \$42.79              | \$16.08 | \$20.56 | \$0.00                    | \$79.43    |
| 5    | 80      | \$48.90              | \$16.08 | \$20.56 | \$0.00                    | \$85.54    |

**Effective Date - 01/01/2024**

| Step | percent | Apprentice Base Wage | Health  | Pension | Supplemental Unemployment | Total Rate |
|------|---------|----------------------|---------|---------|---------------------------|------------|
| 1    | 50      | \$30.99              | \$16.18 | \$0.00  | \$0.00                    | \$47.17    |
| 2    | 55      | \$34.09              | \$16.18 | \$20.96 | \$0.00                    | \$71.23    |
| 3    | 65      | \$40.29              | \$16.18 | \$20.96 | \$0.00                    | \$77.43    |
| 4    | 70      | \$43.39              | \$16.18 | \$20.96 | \$0.00                    | \$80.53    |
| 5    | 80      | \$49.58              | \$16.18 | \$20.96 | \$0.00                    | \$86.72    |

**Notes:**

Steps 1-2 are 6 mos.; Steps 3-5 are 1 year

**Apprentice to Journeyworker Ratio:1:1**

|  |            |         |         |         |        |         |
|--|------------|---------|---------|---------|--------|---------|
| ELEVATOR CONSTRUCTOR HELPER<br><i>ELEVATOR CONSTRUCTORS LOCAL 41</i> | 01/01/2023 | \$42.79 | \$16.08 | \$20.56 | \$0.00 | \$79.43 |
|  | 01/01/2024 | \$43.39 | \$16.18 | \$20.96 | \$0.00 | \$80.53 |
|  | 01/01/2025 | \$43.98 | \$16.28 | \$21.36 | \$0.00 | \$81.62 |
|  | 01/01/2026 | \$44.58 | \$16.38 | \$21.76 | \$0.00 | \$82.72 |
|  | 01/01/2027 | \$45.17 | \$16.48 | \$22.16 | \$0.00 | \$83.81 |

For apprentice rates see "Apprentice - ELEVATOR CONSTRUCTOR"

|  |            |         |        |         |        |         |
|--|------------|---------|--------|---------|--------|---------|
| FENCE & GUARD RAIL ERECTOR (HEAVY & HIGHWAY)<br><i>LABORERS - ZONE 2 (HEAVY &amp; HIGHWAY)</i> | 06/01/2023 | \$37.71 | \$9.40 | \$16.89 | \$0.00 | \$64.00 |
|  | 12/01/2023 | \$38.61 | \$9.40 | \$16.89 | \$0.00 | \$64.90 |
|  | 06/01/2024 | \$39.94 | \$9.40 | \$16.89 | \$0.00 | \$66.23 |
|  | 12/01/2024 | \$41.27 | \$9.40 | \$16.89 | \$0.00 | \$67.56 |
|  | 06/01/2025 | \$42.66 | \$9.40 | \$16.89 | \$0.00 | \$68.95 |
|  | 12/01/2025 | \$44.04 | \$9.40 | \$16.89 | \$0.00 | \$70.33 |
|  | 06/01/2026 | \$45.48 | \$9.40 | \$16.89 | \$0.00 | \$71.77 |
|  | 12/01/2026 | \$46.92 | \$9.40 | \$16.89 | \$0.00 | \$73.21 |

For apprentice rates see "Apprentice- LABORER (Heavy and Highway)"

| Classification  | Effective Date | Base Wage | Health  | Pension | Supplemental Unemployment | Total Rate |
|---|----------------|-----------|---------|---------|---------------------------|------------|
| FIELD ENG.INST.PERSON-BLDG,SITE,HVY/HWY<br><i>OPERATING ENGINEERS LOCAL 4</i> | 05/01/2023     | \$49.06   | \$14.50 | \$16.15 | \$0.00                    | \$79.71    |
|   | 11/01/2023     | \$50.30   | \$14.50 | \$16.15 | \$0.00                    | \$80.95    |
|   | 05/01/2024     | \$51.54   | \$14.50 | \$16.15 | \$0.00                    | \$82.19    |
|   | 11/01/2024     | \$52.83   | \$14.50 | \$16.15 | \$0.00                    | \$83.48    |
|   | 05/01/2025     | \$54.27   | \$14.50 | \$16.15 | \$0.00                    | \$84.92    |
|   | 11/01/2025     | \$55.56   | \$14.50 | \$16.15 | \$0.00                    | \$86.21    |
|   | 05/01/2026     | \$57.00   | \$14.50 | \$16.15 | \$0.00                    | \$87.65    |
|   | 11/01/2026     | \$58.29   | \$14.50 | \$16.15 | \$0.00                    | \$88.94    |
|   | 05/01/2027     | \$59.72   | \$14.50 | \$16.15 | \$0.00                    | \$90.37    |
| For apprentice rates see "Apprentice- OPERATING ENGINEERS"                    |                |           |         |         |                           |            |
| FIELD ENG.PARTY CHIEF-BLDG,SITE,HVY/HWY<br><i>OPERATING ENGINEERS LOCAL 4</i> | 05/01/2023     | \$50.62   | \$14.50 | \$16.15 | \$0.00                    | \$81.27    |
|   | 11/01/2023     | \$51.87   | \$14.50 | \$16.15 | \$0.00                    | \$82.52    |
|   | 05/01/2024     | \$53.12   | \$14.50 | \$16.15 | \$0.00                    | \$83.77    |
|   | 11/01/2024     | \$54.42   | \$14.50 | \$16.15 | \$0.00                    | \$85.07    |
|   | 05/01/2025     | \$55.87   | \$14.50 | \$16.15 | \$0.00                    | \$86.52    |
|   | 11/01/2025     | \$57.17   | \$14.50 | \$16.15 | \$0.00                    | \$87.82    |
|   | 05/01/2026     | \$58.62   | \$14.50 | \$16.15 | \$0.00                    | \$89.27    |
|   | 11/01/2026     | \$59.92   | \$14.50 | \$16.15 | \$0.00                    | \$90.57    |
|   | 05/01/2027     | \$61.37   | \$14.50 | \$16.15 | \$0.00                    | \$92.02    |
| For apprentice rates see "Apprentice- OPERATING ENGINEERS"                    |                |           |         |         |                           |            |
| FIELD ENG.ROD PERSON-BLDG,SITE,HVY/HWY<br><i>OPERATING ENGINEERS LOCAL 4</i>  | 05/01/2023     | \$24.20   | \$14.50 | \$16.15 | \$0.00                    | \$54.85    |
|   | 11/01/2023     | \$24.93   | \$14.50 | \$16.15 | \$0.00                    | \$55.58    |
|   | 05/01/2024     | \$25.66   | \$14.50 | \$16.15 | \$0.00                    | \$56.31    |
|   | 11/01/2024     | \$26.42   | \$14.50 | \$16.15 | \$0.00                    | \$57.07    |
|   | 05/01/2025     | \$27.27   | \$14.50 | \$16.15 | \$0.00                    | \$57.92    |
|   | 11/01/2025     | \$28.03   | \$14.50 | \$16.15 | \$0.00                    | \$58.68    |
|   | 05/01/2026     | \$28.88   | \$14.50 | \$16.15 | \$0.00                    | \$59.53    |
|   | 11/01/2026     | \$29.64   | \$14.50 | \$16.15 | \$0.00                    | \$60.29    |
|   | 05/01/2027     | \$30.49   | \$14.50 | \$16.15 | \$0.00                    | \$61.14    |
| For apprentice rates see "Apprentice- OPERATING ENGINEERS"                    |                |           |         |         |                           |            |
| FIRE ALARM INSTALLER<br><i>ELECTRICIANS LOCAL 96</i>                          | 09/04/2022     | \$45.59   | \$12.20 | \$17.50 | \$0.00                    | \$75.29    |
| For apprentice rates see "Apprentice- ELECTRICIAN"                            |                |           |         |         |                           |            |
| FIRE ALARM REPAIR / MAINT/COMMISSIONING<br><i>ELECTRICIANS LOCAL 96</i>       | 09/04/2022     | \$45.59   | \$12.20 | \$17.50 | \$0.00                    | \$75.29    |
| For apprentice rates see "Apprentice- ELECTRICIAN"                            |                |           |         |         |                           |            |
| FIREMAN (ASST. ENGINEER)<br><i>OPERATING ENGINEERS LOCAL 4</i>                | 06/01/2023     | \$43.96   | \$14.75 | \$16.15 | \$0.00                    | \$74.86    |
|   | 12/01/2023     | \$44.97   | \$14.75 | \$16.15 | \$0.00                    | \$75.87    |
|   | 06/01/2024     | \$46.03   | \$14.75 | \$16.15 | \$0.00                    | \$76.93    |
|   | 12/01/2024     | \$47.21   | \$14.75 | \$16.15 | \$0.00                    | \$78.11    |
|   | 06/01/2025     | \$48.27   | \$14.75 | \$16.15 | \$0.00                    | \$79.17    |
|   | 12/01/2025     | \$49.44   | \$14.75 | \$16.15 | \$0.00                    | \$80.34    |
|   | 06/01/2026     | \$50.50   | \$14.75 | \$16.15 | \$0.00                    | \$81.40    |
|   | 12/01/2026     | \$51.68   | \$14.75 | \$16.15 | \$0.00                    | \$82.58    |
| For apprentice rates see "Apprentice- OPERATING ENGINEERS"                    |                |           |         |         |                           |            |

| Classification   | Effective Date | Base Wage | Health | Pension | Supplemental Unemployment | Total Rate |
|--|----------------|-----------|--------|---------|---------------------------|------------|
| FLAGGER & SIGNALER (HEAVY & HIGHWAY)<br><i>LABORERS - ZONE 2 (HEAVY &amp; HIGHWAY)</i> | 06/01/2023     | \$25.98   | \$9.40 | \$16.89 | \$0.00                    | \$52.27    |
|  | 12/01/2023     | \$25.98   | \$9.40 | \$16.89 | \$0.00                    | \$52.27    |
|  | 06/01/2024     | \$27.01   | \$9.40 | \$16.89 | \$0.00                    | \$53.30    |
|  | 12/01/2024     | \$27.01   | \$9.40 | \$16.89 | \$0.00                    | \$53.30    |
|  | 06/01/2025     | \$28.09   | \$9.40 | \$16.89 | \$0.00                    | \$54.38    |
|  | 12/01/2025     | \$28.09   | \$9.40 | \$16.89 | \$0.00                    | \$54.38    |
|  | 06/01/2026     | \$29.21   | \$9.40 | \$16.89 | \$0.00                    | \$55.50    |
|  | 12/01/2026     | \$29.21   | \$9.40 | \$16.89 | \$0.00                    | \$55.50    |
| For apprentice rates see "Apprentice- LABORER (Heavy and Highway)                      |                |           |        |         |                           |            |
| FLOORCOVERER<br><i>FLOORCOVERERS LOCAL 2168 ZONE II</i>                                | 03/01/2022     | \$47.96   | \$9.33 | \$20.27 | \$0.00                    | \$77.56    |

**Apprentice - FLOORCOVERER - Local 2168 Zone II**

**Effective Date - 03/01/2022**

| Step | percent | Apprentice Base Wage | Health | Pension | Supplemental Unemployment | Total Rate |
|------|---------|----------------------|--------|---------|---------------------------|------------|
| 1    | 50      | \$23.98              | \$9.33 | \$1.79  | \$0.00                    | \$35.10    |
| 2    | 55      | \$26.38              | \$9.33 | \$1.79  | \$0.00                    | \$37.50    |
| 3    | 60      | \$28.78              | \$9.33 | \$14.90 | \$0.00                    | \$53.01    |
| 4    | 65      | \$31.17              | \$9.33 | \$14.90 | \$0.00                    | \$55.40    |
| 5    | 70      | \$33.57              | \$9.33 | \$16.69 | \$0.00                    | \$59.59    |
| 6    | 75      | \$35.97              | \$9.33 | \$16.69 | \$0.00                    | \$61.99    |
| 7    | 80      | \$38.37              | \$9.33 | \$18.48 | \$0.00                    | \$66.18    |
| 8    | 85      | \$40.77              | \$9.33 | \$18.48 | \$0.00                    | \$68.58    |

**Notes:** Steps are 750 hrs.  
 % After 10/1/17; 45/45/55/55/70/70/80/80 (1500hr Steps)  
 Step 1&2 \$31.90/ 3&4 \$38.39/ 5&6 \$58.70/ 7&8 \$65.26

**Apprentice to Journeyworker Ratio:1:1**

|   |            |         |         |         |        |         |
|---|------------|---------|---------|---------|--------|---------|
| FORK LIFT/CHERRY PICKER<br><i>OPERATING ENGINEERS LOCAL 4</i> | 06/01/2023 | \$54.28 | \$14.75 | \$16.15 | \$0.00 | \$85.18 |
|   | 12/01/2023 | \$55.53 | \$14.75 | \$16.15 | \$0.00 | \$86.43 |
|   | 06/01/2024 | \$56.83 | \$14.75 | \$16.15 | \$0.00 | \$87.73 |
|   | 12/01/2024 | \$58.28 | \$14.75 | \$16.15 | \$0.00 | \$89.18 |
|   | 06/01/2025 | \$59.58 | \$14.75 | \$16.15 | \$0.00 | \$90.48 |
|   | 12/01/2025 | \$61.03 | \$14.75 | \$16.15 | \$0.00 | \$91.93 |
|   | 06/01/2026 | \$62.33 | \$14.75 | \$16.15 | \$0.00 | \$93.23 |
|   | 12/01/2026 | \$63.78 | \$14.75 | \$16.15 | \$0.00 | \$94.68 |

For apprentice rates see "Apprentice- OPERATING ENGINEERS"

|  |            |         |         |         |        |         |
|--|------------|---------|---------|---------|--------|---------|
| GENERATOR/LIGHTING PLANT/HEATERS<br><i>OPERATING ENGINEERS LOCAL 4</i> | 06/01/2023 | \$35.30 | \$14.75 | \$16.15 | \$0.00 | \$66.20 |
|  | 12/01/2023 | \$36.12 | \$14.75 | \$16.15 | \$0.00 | \$67.02 |
|  | 06/01/2024 | \$36.97 | \$14.75 | \$16.15 | \$0.00 | \$67.87 |
|  | 12/01/2024 | \$37.92 | \$14.75 | \$16.15 | \$0.00 | \$68.82 |
|  | 06/01/2025 | \$38.77 | \$14.75 | \$16.15 | \$0.00 | \$69.67 |
|  | 12/01/2025 | \$39.72 | \$14.75 | \$16.15 | \$0.00 | \$70.62 |
|  | 06/01/2026 | \$40.58 | \$14.75 | \$16.15 | \$0.00 | \$71.48 |
|  | 12/01/2026 | \$41.53 | \$14.75 | \$16.15 | \$0.00 | \$72.43 |

For apprentice rates see "Apprentice- OPERATING ENGINEERS"

| Classification  | Effective Date | Base Wage | Health | Pension | Supplemental Unemployment | Total Rate |
|---|----------------|-----------|--------|---------|---------------------------|------------|
| GLAZIER (GLASS PLANK/AIR BARRIER/INTERIOR SYSTEMS)<br><i>GLAZIERS LOCAL 35 (ZONE 2)</i> | 07/01/2023     | \$45.01   | \$9.65 | \$23.70 | \$0.00                    | \$78.36    |
|   | 01/01/2024     | \$45.56   | \$9.95 | \$23.95 | \$0.00                    | \$79.46    |
|   | 07/01/2024     | \$46.76   | \$9.95 | \$23.95 | \$0.00                    | \$80.66    |
|   | 01/01/2025     | \$47.96   | \$9.95 | \$23.95 | \$0.00                    | \$81.86    |

**Apprentice - GLAZIER - Local 35 Zone 2**

**Effective Date - 07/01/2023**

| Step | percent | Apprentice Base Wage | Health | Pension | Supplemental Unemployment | Total Rate |
|------|---------|----------------------|--------|---------|---------------------------|------------|
| 1    | 50      | \$22.51              | \$9.65 | \$0.00  | \$0.00                    | \$32.16    |
| 2    | 55      | \$24.76              | \$9.65 | \$6.55  | \$0.00                    | \$40.96    |
| 3    | 60      | \$27.01              | \$9.65 | \$7.14  | \$0.00                    | \$43.80    |
| 4    | 65      | \$29.26              | \$9.65 | \$7.74  | \$0.00                    | \$46.65    |
| 5    | 70      | \$31.51              | \$9.65 | \$20.13 | \$0.00                    | \$61.29    |
| 6    | 75      | \$33.76              | \$9.65 | \$20.73 | \$0.00                    | \$64.14    |
| 7    | 80      | \$36.01              | \$9.65 | \$21.32 | \$0.00                    | \$66.98    |
| 8    | 90      | \$40.51              | \$9.65 | \$22.51 | \$0.00                    | \$72.67    |

**Effective Date - 01/01/2024**

| Step | percent | Apprentice Base Wage | Health | Pension | Supplemental Unemployment | Total Rate |
|------|---------|----------------------|--------|---------|---------------------------|------------|
| 1    | 50      | \$22.78              | \$9.95 | \$0.00  | \$0.00                    | \$32.73    |
| 2    | 55      | \$25.06              | \$9.95 | \$6.66  | \$0.00                    | \$41.67    |
| 3    | 60      | \$27.34              | \$9.95 | \$7.26  | \$0.00                    | \$44.55    |
| 4    | 65      | \$29.61              | \$9.95 | \$7.87  | \$0.00                    | \$47.43    |
| 5    | 70      | \$31.89              | \$9.95 | \$20.32 | \$0.00                    | \$62.16    |
| 6    | 75      | \$34.17              | \$9.95 | \$20.93 | \$0.00                    | \$65.05    |
| 7    | 80      | \$36.45              | \$9.95 | \$21.53 | \$0.00                    | \$67.93    |
| 8    | 90      | \$41.00              | \$9.95 | \$22.74 | \$0.00                    | \$73.69    |

**Notes:**

Steps are 750 hrs.

**Apprentice to Journeyworker Ratio:1:1**

|   |            |         |         |         |        |         |
|---|------------|---------|---------|---------|--------|---------|
| HOISTING ENGINEER/CRANES/GRADALLS<br><i>OPERATING ENGINEERS LOCAL 4</i> | 06/01/2023 | \$54.28 | \$14.75 | \$16.15 | \$0.00 | \$85.18 |
|   | 12/01/2023 | \$55.53 | \$14.75 | \$16.15 | \$0.00 | \$86.43 |
|   | 06/01/2024 | \$56.83 | \$14.75 | \$16.15 | \$0.00 | \$87.73 |
|   | 12/01/2024 | \$58.28 | \$14.75 | \$16.15 | \$0.00 | \$89.18 |
|   | 06/01/2025 | \$59.58 | \$14.75 | \$16.15 | \$0.00 | \$90.48 |
|   | 12/01/2025 | \$61.03 | \$14.75 | \$16.15 | \$0.00 | \$91.93 |
|   | 06/01/2026 | \$62.33 | \$14.75 | \$16.15 | \$0.00 | \$93.23 |
|   | 12/01/2026 | \$63.78 | \$14.75 | \$16.15 | \$0.00 | \$94.68 |



**Classification**

**Effective Date    Base Wage    Health    Pension    Supplemental  
Unemployment    Total Rate**

**Apprentice - OPERATING ENGINEERS - Local 4**

**Effective Date - 06/01/2023**

| Step | percent | Apprentice Base Wage | Health  | Pension | Supplemental<br>Unemployment | Total Rate |
|------|---------|----------------------|---------|---------|------------------------------|------------|
| 1    | 55      | \$29.85              | \$14.75 | \$0.00  | \$0.00                       | \$44.60    |
| 2    | 60      | \$32.57              | \$14.75 | \$16.15 | \$0.00                       | \$63.47    |
| 3    | 65      | \$35.28              | \$14.75 | \$16.15 | \$0.00                       | \$66.18    |
| 4    | 70      | \$38.00              | \$14.75 | \$16.15 | \$0.00                       | \$68.90    |
| 5    | 75      | \$40.71              | \$14.75 | \$16.15 | \$0.00                       | \$71.61    |
| 6    | 80      | \$43.42              | \$14.75 | \$16.15 | \$0.00                       | \$74.32    |
| 7    | 85      | \$46.14              | \$14.75 | \$16.15 | \$0.00                       | \$77.04    |
| 8    | 90      | \$48.85              | \$14.75 | \$16.15 | \$0.00                       | \$79.75    |

**Effective Date - 12/01/2023**

| Step | percent | Apprentice Base Wage | Health  | Pension | Supplemental<br>Unemployment | Total Rate |
|------|---------|----------------------|---------|---------|------------------------------|------------|
| 1    | 55      | \$30.54              | \$14.75 | \$0.00  | \$0.00                       | \$45.29    |
| 2    | 60      | \$33.32              | \$14.75 | \$16.15 | \$0.00                       | \$64.22    |
| 3    | 65      | \$36.09              | \$14.75 | \$16.15 | \$0.00                       | \$66.99    |
| 4    | 70      | \$38.87              | \$14.75 | \$16.15 | \$0.00                       | \$69.77    |
| 5    | 75      | \$41.65              | \$14.75 | \$16.15 | \$0.00                       | \$72.55    |
| 6    | 80      | \$44.42              | \$14.75 | \$16.15 | \$0.00                       | \$75.32    |
| 7    | 85      | \$47.20              | \$14.75 | \$16.15 | \$0.00                       | \$78.10    |
| 8    | 90      | \$49.98              | \$14.75 | \$16.15 | \$0.00                       | \$80.88    |

**Notes:**

**Apprentice to Journeyworker Ratio:1:6**

|  |            |         |         |         |        |         |
|--|------------|---------|---------|---------|--------|---------|
| HVAC (DUCTWORK)<br>SHEETMETAL WORKERS LOCAL 63 | 07/01/2023 | \$42.55 | \$10.64 | \$17.54 | \$2.05 | \$72.78 |
|  | 01/01/2024 | \$43.80 | \$10.64 | \$17.54 | \$2.05 | \$74.03 |
|  | 07/01/2024 | \$45.05 | \$10.64 | \$17.54 | \$2.05 | \$75.28 |
|  | 01/01/2025 | \$46.30 | \$10.64 | \$17.54 | \$2.05 | \$76.53 |

For apprentice rates see "Apprentice- SHEET METAL WORKER"

|   |            |         |         |         |        |         |
|---|------------|---------|---------|---------|--------|---------|
| HVAC (ELECTRICAL CONTROLS)<br>ELECTRICIANS LOCAL 96 | 09/04/2022 | \$45.59 | \$12.20 | \$17.50 | \$0.00 | \$75.29 |
|---|------------|---------|---------|---------|--------|---------|

For apprentice rates see "Apprentice- ELECTRICIAN"

|   |            |         |         |         |        |         |
|---|------------|---------|---------|---------|--------|---------|
| HVAC (TESTING AND BALANCING - AIR)<br>SHEETMETAL WORKERS LOCAL 63 | 07/01/2023 | \$42.55 | \$10.64 | \$17.54 | \$2.05 | \$72.78 |
|   | 01/01/2024 | \$43.80 | \$10.64 | \$17.54 | \$2.05 | \$74.03 |
|   | 07/01/2024 | \$45.05 | \$10.64 | \$17.54 | \$2.05 | \$75.28 |
|   | 01/01/2025 | \$46.30 | \$10.64 | \$17.54 | \$2.05 | \$76.53 |

For apprentice rates see "Apprentice- SHEET METAL WORKER"

| Classification   | Effective Date | Base Wage | Health  | Pension | Supplemental Unemployment | Total Rate |
|--|----------------|-----------|---------|---------|---------------------------|------------|
| HVAC (TESTING AND BALANCING -WATER)<br><i>PLUMBERS LOCAL 4</i>                       | 09/01/2023     | \$52.55   | \$9.90  | \$17.42 | \$0.00                    | \$79.87    |
|  | 03/01/2024     | \$53.95   | \$9.90  | \$17.42 | \$0.00                    | \$81.27    |
|  | 09/01/2024     | \$55.35   | \$9.90  | \$17.42 | \$0.00                    | \$82.67    |
|  | 03/01/2025     | \$56.75   | \$9.90  | \$17.42 | \$0.00                    | \$84.07    |
|  | 09/01/2025     | \$58.15   | \$9.90  | \$17.42 | \$0.00                    | \$85.47    |
|  | 03/01/2026     | \$59.55   | \$9.90  | \$17.42 | \$0.00                    | \$86.87    |
| For apprentice rates see "Apprentice- PIPEFITTER" or "PLUMBER/PIPEFITTER"            |                |           |         |         |                           |            |
| HVAC MECHANIC<br><i>PLUMBERS LOCAL 4</i>   | 09/01/2023     | \$52.55   | \$9.90  | \$17.42 | \$0.00                    | \$79.87    |
|  | 03/01/2024     | \$53.95   | \$9.90  | \$17.42 | \$0.00                    | \$81.27    |
|  | 09/01/2024     | \$55.35   | \$9.90  | \$17.42 | \$0.00                    | \$82.67    |
|  | 03/01/2025     | \$56.75   | \$9.90  | \$17.42 | \$0.00                    | \$84.07    |
|  | 09/01/2025     | \$58.15   | \$9.90  | \$17.42 | \$0.00                    | \$85.47    |
|  | 03/01/2026     | \$59.55   | \$9.90  | \$17.42 | \$0.00                    | \$86.87    |
| For apprentice rates see "Apprentice- PIPEFITTER" or "PLUMBER/PIPEFITTER"            |                |           |         |         |                           |            |
| HYDRAULIC DRILLS<br><i>LABORERS - ZONE 2</i>   | 06/01/2023     | \$38.21   | \$9.40  | \$16.89 | \$0.00                    | \$64.50    |
|  | 12/01/2023     | \$39.11   | \$9.40  | \$16.89 | \$0.00                    | \$65.40    |
| For apprentice rates see "Apprentice- LABORER"                                       |                |           |         |         |                           |            |
| HYDRAULIC DRILLS (HEAVY & HIGHWAY)<br><i>LABORERS - ZONE 2 (HEAVY &amp; HIGHWAY)</i> | 06/01/2023     | \$38.21   | \$9.40  | \$16.89 | \$0.00                    | \$64.50    |
|  | 12/01/2023     | \$39.11   | \$9.40  | \$16.89 | \$0.00                    | \$65.40    |
|  | 06/01/2024     | \$40.44   | \$9.40  | \$16.89 | \$0.00                    | \$66.73    |
|  | 12/01/2024     | \$41.77   | \$9.40  | \$16.89 | \$0.00                    | \$68.06    |
|  | 06/01/2025     | \$43.16   | \$9.40  | \$16.89 | \$0.00                    | \$69.45    |
|  | 12/01/2025     | \$44.54   | \$9.40  | \$16.89 | \$0.00                    | \$70.83    |
|  | 06/01/2026     | \$45.98   | \$9.40  | \$16.89 | \$0.00                    | \$72.27    |
| 12/01/2026   | \$47.42        | \$9.40    | \$16.89 | \$0.00  | \$73.71                   |            |
| For apprentice rates see "Apprentice- LABORER (Heavy and Highway)"                   |                |           |         |         |                           |            |
| INSULATOR (PIPES & TANKS)<br><i>HEAT &amp; FROST INSULATORS LOCAL 6 (WORCESTER)</i>  | 09/01/2023     | \$48.15   | \$14.75 | \$19.61 | \$0.00                    | \$82.51    |
|  | 09/01/2024     | \$51.23   | \$14.75 | \$19.61 | \$0.00                    | \$85.59    |
|  | 09/01/2025     | \$54.31   | \$14.75 | \$19.61 | \$0.00                    | \$88.67    |
|  | 09/01/2026     | \$57.38   | \$14.75 | \$19.61 | \$0.00                    | \$91.74    |

**Classification**

**Effective Date   Base Wage   Health   Pension   Supplemental Unemployment   Total Rate**

**Apprentice - ASBESTOS INSULATOR (Pipes & Tanks) - Local 6 Worcester**

**Effective Date - 09/01/2023**

| Step | percent | Apprentice Base Wage | Health  | Pension | Supplemental Unemployment | Total Rate |
|------|---------|----------------------|---------|---------|---------------------------|------------|
| 1    | 50      | \$24.08              | \$14.75 | \$14.32 | \$0.00                    | \$53.15    |
| 2    | 60      | \$28.89              | \$14.75 | \$15.37 | \$0.00                    | \$59.01    |
| 3    | 70      | \$33.71              | \$14.75 | \$16.43 | \$0.00                    | \$64.89    |
| 4    | 80      | \$38.52              | \$14.75 | \$17.49 | \$0.00                    | \$70.76    |

**Effective Date - 09/01/2024**

| Step | percent | Apprentice Base Wage | Health  | Pension | Supplemental Unemployment | Total Rate |
|------|---------|----------------------|---------|---------|---------------------------|------------|
| 1    | 50      | \$25.62              | \$14.75 | \$14.32 | \$0.00                    | \$54.69    |
| 2    | 60      | \$30.74              | \$14.75 | \$15.37 | \$0.00                    | \$60.86    |
| 3    | 70      | \$35.86              | \$14.75 | \$16.43 | \$0.00                    | \$67.04    |
| 4    | 80      | \$40.98              | \$14.75 | \$17.49 | \$0.00                    | \$73.22    |

**Notes:**

Steps are 1 year

**Apprentice to Journeyworker Ratio:1:4**

|                                      |            |         |        |         |        |         |
|--------------------------------------|------------|---------|--------|---------|--------|---------|
| IRONWORKER/WELDER                    | 03/16/2023 | \$52.42 | \$8.35 | \$26.70 | \$0.00 | \$87.47 |
| IRONWORKERS LOCAL 7 (WORCESTER AREA) | 03/16/2024 | \$53.67 | \$8.35 | \$26.70 | \$0.00 | \$88.72 |

**Apprentice - IRONWORKER - Local 7 Worcester**

**Effective Date - 03/16/2023**

| Step | percent | Apprentice Base Wage | Health | Pension | Supplemental Unemployment | Total Rate |
|------|---------|----------------------|--------|---------|---------------------------|------------|
| 1    | 60      | \$31.45              | \$8.35 | \$26.70 | \$0.00                    | \$66.50    |
| 2    | 70      | \$36.69              | \$8.35 | \$26.70 | \$0.00                    | \$71.74    |
| 3    | 75      | \$39.32              | \$8.35 | \$26.70 | \$0.00                    | \$74.37    |
| 4    | 80      | \$41.94              | \$8.35 | \$26.70 | \$0.00                    | \$76.99    |
| 5    | 85      | \$44.56              | \$8.35 | \$26.70 | \$0.00                    | \$79.61    |
| 6    | 90      | \$47.18              | \$8.35 | \$26.70 | \$0.00                    | \$82.23    |

**Effective Date - 03/16/2024**

| Step | percent | Apprentice Base Wage | Health | Pension | Supplemental Unemployment | Total Rate |
|------|---------|----------------------|--------|---------|---------------------------|------------|
| 1    | 60      | \$32.20              | \$8.35 | \$26.70 | \$0.00                    | \$67.25    |
| 2    | 70      | \$37.57              | \$8.35 | \$26.70 | \$0.00                    | \$72.62    |
| 3    | 75      | \$40.25              | \$8.35 | \$26.70 | \$0.00                    | \$75.30    |
| 4    | 80      | \$42.94              | \$8.35 | \$26.70 | \$0.00                    | \$77.99    |
| 5    | 85      | \$45.62              | \$8.35 | \$26.70 | \$0.00                    | \$80.67    |
| 6    | 90      | \$48.30              | \$8.35 | \$26.70 | \$0.00                    | \$83.35    |

**Notes:**

**Apprentice to Journeyworker Ratio:1:4**

| Classification  | Effective Date | Base Wage | Health | Pension | Supplemental Unemployment | Total Rate |
|---|----------------|-----------|--------|---------|---------------------------|------------|
| JACKHAMMER & PAVING BREAKER OPERATOR<br>LABORERS - ZONE 2 | 06/01/2023     | \$37.71   | \$9.40 | \$16.89 | \$0.00                    | \$64.00    |
|   | 12/01/2023     | \$38.61   | \$9.40 | \$16.89 | \$0.00                    | \$64.90    |
| For apprentice rates see "Apprentice- LABORER"            |                |           |        |         |                           |            |
| LABORER<br>LABORERS - ZONE 2                              | 06/01/2023     | \$37.46   | \$9.40 | \$16.89 | \$0.00                    | \$63.75    |
|   | 12/01/2023     | \$38.36   | \$9.40 | \$16.89 | \$0.00                    | \$64.65    |

**Apprentice - LABORER - Zone 2**

**Effective Date - 06/01/2023**

| Step | percent | Apprentice Base Wage | Health | Pension | Supplemental Unemployment | Total Rate |
|------|---------|----------------------|--------|---------|---------------------------|------------|
| 1    | 60      | \$22.48              | \$9.40 | \$16.89 | \$0.00                    | \$48.77    |
| 2    | 70      | \$26.22              | \$9.40 | \$16.89 | \$0.00                    | \$52.51    |
| 3    | 80      | \$29.97              | \$9.40 | \$16.89 | \$0.00                    | \$56.26    |
| 4    | 90      | \$33.71              | \$9.40 | \$16.89 | \$0.00                    | \$60.00    |

**Effective Date - 12/01/2023**

| Step | percent | Apprentice Base Wage | Health | Pension | Supplemental Unemployment | Total Rate |
|------|---------|----------------------|--------|---------|---------------------------|------------|
| 1    | 60      | \$23.02              | \$9.40 | \$16.89 | \$0.00                    | \$49.31    |
| 2    | 70      | \$26.85              | \$9.40 | \$16.89 | \$0.00                    | \$53.14    |
| 3    | 80      | \$30.69              | \$9.40 | \$16.89 | \$0.00                    | \$56.98    |
| 4    | 90      | \$34.52              | \$9.40 | \$16.89 | \$0.00                    | \$60.81    |

**Notes:**

**Apprentice to Journeyworker Ratio:1:5**

|  |            |         |        |         |        |         |
|--|------------|---------|--------|---------|--------|---------|
| LABORER (HEAVY & HIGHWAY)<br>LABORERS - ZONE 2 (HEAVY & HIGHWAY) | 06/01/2023 | \$37.46 | \$9.40 | \$16.89 | \$0.00 | \$63.75 |
|  | 12/01/2023 | \$38.36 | \$9.40 | \$16.89 | \$0.00 | \$64.65 |
|  | 06/01/2024 | \$39.69 | \$9.40 | \$16.89 | \$0.00 | \$65.98 |
|  | 12/01/2024 | \$41.02 | \$9.40 | \$16.89 | \$0.00 | \$67.31 |
|  | 06/01/2025 | \$42.41 | \$9.40 | \$16.89 | \$0.00 | \$68.70 |
|  | 12/01/2025 | \$43.79 | \$9.40 | \$16.89 | \$0.00 | \$70.08 |
|  | 06/01/2026 | \$45.23 | \$9.40 | \$16.89 | \$0.00 | \$71.52 |
|  | 12/01/2026 | \$46.67 | \$9.40 | \$16.89 | \$0.00 | \$72.96 |

|                       |                       |                  |               |                |                                  |                   |
|-----------------------|-----------------------|------------------|---------------|----------------|----------------------------------|-------------------|
| <b>Classification</b> | <b>Effective Date</b> | <b>Base Wage</b> | <b>Health</b> | <b>Pension</b> | <b>Supplemental Unemployment</b> | <b>Total Rate</b> |
|-----------------------|-----------------------|------------------|---------------|----------------|----------------------------------|-------------------|

**Apprentice - LABORER (Heavy & Highway) - Zone 2**

**Effective Date - 06/01/2023**

| Step | percent | Apprentice Base Wage | Health | Pension | Supplemental Unemployment | Total Rate |
|------|---------|----------------------|--------|---------|---------------------------|------------|
| 1    | 60      | \$22.48              | \$9.40 | \$16.89 | \$0.00                    | \$48.77    |
| 2    | 70      | \$26.22              | \$9.40 | \$16.89 | \$0.00                    | \$52.51    |
| 3    | 80      | \$29.97              | \$9.40 | \$16.89 | \$0.00                    | \$56.26    |
| 4    | 90      | \$33.71              | \$9.40 | \$16.89 | \$0.00                    | \$60.00    |

**Effective Date - 12/01/2023**

| Step | percent | Apprentice Base Wage | Health | Pension | Supplemental Unemployment | Total Rate |
|------|---------|----------------------|--------|---------|---------------------------|------------|
| 1    | 60      | \$23.02              | \$9.40 | \$16.89 | \$0.00                    | \$49.31    |
| 2    | 70      | \$26.85              | \$9.40 | \$16.89 | \$0.00                    | \$53.14    |
| 3    | 80      | \$30.69              | \$9.40 | \$16.89 | \$0.00                    | \$56.98    |
| 4    | 90      | \$34.52              | \$9.40 | \$16.89 | \$0.00                    | \$60.81    |

**Notes:**

**Apprentice to Journeyworker Ratio:1:5**

|  |            |         |        |         |        |         |
|--|------------|---------|--------|---------|--------|---------|
| <b>LABORER: CARPENTER TENDER</b><br><i>LABORERS - ZONE 2</i> | 06/01/2023 | \$37.46 | \$9.40 | \$16.89 | \$0.00 | \$63.75 |
|--|------------|---------|--------|---------|--------|---------|

For apprentice rates see "Apprentice- LABORER"

|  |            |         |        |         |        |         |
|--|------------|---------|--------|---------|--------|---------|
|  | 12/01/2023 | \$38.36 | \$9.40 | \$16.89 | \$0.00 | \$64.65 |
|--|------------|---------|--------|---------|--------|---------|

|  |            |         |        |         |        |         |
|--|------------|---------|--------|---------|--------|---------|
| <b>LABORER: CEMENT FINISHER TENDER</b><br><i>LABORERS - ZONE 2</i> | 06/01/2023 | \$37.46 | \$9.40 | \$16.89 | \$0.00 | \$63.75 |
|--|------------|---------|--------|---------|--------|---------|

For apprentice rates see "Apprentice- LABORER"

|  |            |         |        |         |        |         |
|--|------------|---------|--------|---------|--------|---------|
|  | 12/01/2023 | \$38.36 | \$9.40 | \$16.89 | \$0.00 | \$64.65 |
|--|------------|---------|--------|---------|--------|---------|

|  |            |         |        |         |        |         |
|--|------------|---------|--------|---------|--------|---------|
| <b>LABORER: HAZARDOUS WASTE/ASBESTOS REMOVER</b><br><i>LABORERS - ZONE 2</i> | 06/01/2023 | \$37.55 | \$9.40 | \$16.95 | \$0.00 | \$63.90 |
|--|------------|---------|--------|---------|--------|---------|

For apprentice rates see "Apprentice- LABORER"

|  |            |         |        |         |        |         |
|--|------------|---------|--------|---------|--------|---------|
|  | 12/01/2023 | \$38.45 | \$9.40 | \$16.95 | \$0.00 | \$64.80 |
|--|------------|---------|--------|---------|--------|---------|

|  |            |         |        |         |        |         |
|--|------------|---------|--------|---------|--------|---------|
| <b>LABORER: MASON TENDER</b><br><i>LABORERS - ZONE 2</i> | 06/01/2023 | \$37.71 | \$9.40 | \$16.89 | \$0.00 | \$64.00 |
|--|------------|---------|--------|---------|--------|---------|

For apprentice rates see "Apprentice- LABORER"

|  |            |         |        |         |        |         |
|--|------------|---------|--------|---------|--------|---------|
|  | 12/01/2023 | \$38.61 | \$9.40 | \$16.89 | \$0.00 | \$64.90 |
|--|------------|---------|--------|---------|--------|---------|

|  |            |         |        |         |        |         |
|--|------------|---------|--------|---------|--------|---------|
| <b>LABORER: MASON TENDER (HEAVY &amp; HIGHWAY)</b><br><i>LABORERS - ZONE 2 (HEAVY &amp; HIGHWAY)</i> | 06/01/2023 | \$37.71 | \$9.40 | \$16.89 | \$0.00 | \$64.00 |
|--|------------|---------|--------|---------|--------|---------|

|  |            |         |        |         |        |         |
|--|------------|---------|--------|---------|--------|---------|
|  | 12/01/2023 | \$38.61 | \$9.40 | \$16.89 | \$0.00 | \$64.90 |
|--|------------|---------|--------|---------|--------|---------|

|  |            |         |        |         |        |         |
|--|------------|---------|--------|---------|--------|---------|
|  | 06/01/2024 | \$39.94 | \$9.40 | \$16.89 | \$0.00 | \$66.23 |
|--|------------|---------|--------|---------|--------|---------|

|  |            |         |        |         |        |         |
|--|------------|---------|--------|---------|--------|---------|
|  | 12/01/2024 | \$41.27 | \$9.40 | \$16.89 | \$0.00 | \$67.56 |
|--|------------|---------|--------|---------|--------|---------|

|  |            |         |        |         |        |         |
|--|------------|---------|--------|---------|--------|---------|
|  | 06/01/2025 | \$42.66 | \$9.40 | \$16.89 | \$0.00 | \$68.95 |
|--|------------|---------|--------|---------|--------|---------|

|  |            |         |        |         |        |         |
|--|------------|---------|--------|---------|--------|---------|
|  | 12/01/2025 | \$44.04 | \$9.40 | \$16.89 | \$0.00 | \$70.33 |
|--|------------|---------|--------|---------|--------|---------|

|  |            |         |        |         |        |         |
|--|------------|---------|--------|---------|--------|---------|
|  | 06/01/2026 | \$45.48 | \$9.40 | \$16.89 | \$0.00 | \$71.77 |
|--|------------|---------|--------|---------|--------|---------|

|  |            |         |        |         |        |         |
|--|------------|---------|--------|---------|--------|---------|
|  | 12/01/2026 | \$46.92 | \$9.40 | \$16.89 | \$0.00 | \$73.21 |
|--|------------|---------|--------|---------|--------|---------|

For apprentice rates see "Apprentice- LABORER (Heavy and Highway)"

|  |            |         |        |         |        |         |
|--|------------|---------|--------|---------|--------|---------|
| <b>LABORER: MULTI-TRADE TENDER</b><br><i>LABORERS - ZONE 2</i> | 06/01/2023 | \$37.46 | \$9.40 | \$16.89 | \$0.00 | \$63.75 |
|--|------------|---------|--------|---------|--------|---------|

For apprentice rates see "Apprentice- LABORER"

|  |            |         |        |         |        |         |
|--|------------|---------|--------|---------|--------|---------|
|  | 12/01/2023 | \$38.36 | \$9.40 | \$16.89 | \$0.00 | \$64.65 |
|--|------------|---------|--------|---------|--------|---------|

|  |            |         |        |         |        |         |
|--|------------|---------|--------|---------|--------|---------|
| <b>LABORER: TREE REMOVER</b><br><i>LABORERS - ZONE 2</i> | 06/01/2023 | \$37.46 | \$9.40 | \$16.89 | \$0.00 | \$63.75 |
|--|------------|---------|--------|---------|--------|---------|

This classification applies to the removal of standing trees, and the trimming and removal of branches and limbs when related to public works construction or site clearance incidental to construction . For apprentice rates see "Apprentice- LABORER"

| Classification  | Effective Date | Base Wage | Health  | Pension | Supplemental Unemployment | Total Rate |
|---|----------------|-----------|---------|---------|---------------------------|------------|
| LASER BEAM OPERATOR<br><i>LABORERS - ZONE 2</i>   | 06/01/2023     | \$37.71   | \$9.40  | \$16.89 | \$0.00                    | \$64.00    |
|   | 12/01/2023     | \$38.61   | \$9.40  | \$16.89 | \$0.00                    | \$64.90    |
| For apprentice rates see "Apprentice- LABORER"  |                |           |         |         |                           |            |
| LASER BEAM OPERATOR (HEAVY & HIGHWAY)<br><i>LABORERS - ZONE 2 (HEAVY &amp; HIGHWAY)</i> | 06/01/2023     | \$37.71   | \$9.40  | \$16.89 | \$0.00                    | \$64.00    |
|   | 12/01/2023     | \$38.61   | \$9.40  | \$16.89 | \$0.00                    | \$64.90    |
|   | 06/01/2024     | \$39.94   | \$9.40  | \$16.89 | \$0.00                    | \$66.23    |
|   | 12/01/2024     | \$41.27   | \$9.40  | \$16.89 | \$0.00                    | \$67.56    |
|   | 06/01/2025     | \$42.66   | \$9.40  | \$16.89 | \$0.00                    | \$68.95    |
|   | 12/01/2025     | \$44.04   | \$9.40  | \$16.89 | \$0.00                    | \$70.33    |
|   | 06/01/2026     | \$45.48   | \$9.40  | \$16.89 | \$0.00                    | \$71.77    |
|   | 12/01/2026     | \$46.92   | \$9.40  | \$16.89 | \$0.00                    | \$73.21    |
| For apprentice rates see "Apprentice- LABORER (Heavy and Highway)"                      |                |           |         |         |                           |            |
| MARBLE & TILE FINISHERS<br><i>BRICKLAYERS LOCAL 3 - MARBLE &amp; TILE</i>               | 08/01/2023     | \$47.89   | \$11.49 | \$20.37 | \$0.00                    | \$79.75    |
|   | 02/01/2024     | \$48.89   | \$11.49 | \$20.37 | \$0.00                    | \$80.75    |
|   | 08/01/2024     | \$50.57   | \$11.49 | \$20.37 | \$0.00                    | \$82.43    |
|   | 02/01/2025     | \$51.61   | \$11.49 | \$20.37 | \$0.00                    | \$83.47    |
|   | 08/01/2025     | \$53.33   | \$11.49 | \$20.37 | \$0.00                    | \$85.19    |
|   | 02/01/2026     | \$54.41   | \$11.49 | \$20.37 | \$0.00                    | \$86.27    |
|   | 08/01/2026     | \$56.17   | \$11.49 | \$20.37 | \$0.00                    | \$88.03    |
|   | 02/01/2027     | \$57.29   | \$11.49 | \$20.37 | \$0.00                    | \$89.15    |

**Apprentice - MARBLE & TILE FINISHER - Local 3 Marble & Tile**

**Effective Date - 08/01/2023**

| Step | percent | Apprentice Base Wage | Health  | Pension | Supplemental Unemployment | Total Rate |
|------|---------|----------------------|---------|---------|---------------------------|------------|
| 1    | 50      | \$23.95              | \$11.49 | \$20.37 | \$0.00                    | \$55.81    |
| 2    | 60      | \$28.73              | \$11.49 | \$20.37 | \$0.00                    | \$60.59    |
| 3    | 70      | \$33.52              | \$11.49 | \$20.37 | \$0.00                    | \$65.38    |
| 4    | 80      | \$38.31              | \$11.49 | \$20.37 | \$0.00                    | \$70.17    |
| 5    | 90      | \$43.10              | \$11.49 | \$20.37 | \$0.00                    | \$74.96    |

**Effective Date - 02/01/2024**

| Step | percent | Apprentice Base Wage | Health  | Pension | Supplemental Unemployment | Total Rate |
|------|---------|----------------------|---------|---------|---------------------------|------------|
| 1    | 50      | \$24.45              | \$11.49 | \$20.37 | \$0.00                    | \$56.31    |
| 2    | 60      | \$29.33              | \$11.49 | \$20.37 | \$0.00                    | \$61.19    |
| 3    | 70      | \$34.22              | \$11.49 | \$20.37 | \$0.00                    | \$66.08    |
| 4    | 80      | \$39.11              | \$11.49 | \$20.37 | \$0.00                    | \$70.97    |
| 5    | 90      | \$44.00              | \$11.49 | \$20.37 | \$0.00                    | \$75.86    |

**Notes:**

**Apprentice to Journeyworker Ratio:1:3**

| Classification  | Effective Date | Base Wage | Health  | Pension | Supplemental Unemployment | Total Rate |
|---|----------------|-----------|---------|---------|---------------------------|------------|
| MARBLE MASONS, TILELAYERS & TERRAZZO MECH<br><i>BRICKLAYERS LOCAL 3 - MARBLE &amp; TILE</i> | 08/01/2023     | \$62.42   | \$11.49 | \$22.31 | \$0.00                    | \$96.22    |
|   | 02/01/2024     | \$63.67   | \$11.49 | \$22.31 | \$0.00                    | \$97.47    |
|   | 08/01/2024     | \$65.77   | \$11.49 | \$22.31 | \$0.00                    | \$99.57    |
|   | 02/01/2025     | \$67.07   | \$11.49 | \$22.31 | \$0.00                    | \$100.87   |
|   | 08/01/2025     | \$69.22   | \$11.49 | \$22.31 | \$0.00                    | \$103.02   |
|   | 02/01/2026     | \$70.57   | \$11.49 | \$22.31 | \$0.00                    | \$104.37   |
|   | 08/01/2026     | \$72.77   | \$11.49 | \$22.31 | \$0.00                    | \$106.57   |
|   | 02/01/2027     | \$74.17   | \$11.49 | \$22.31 | \$0.00                    | \$107.97   |

**Apprentice - MARBLE-TILE-TERRAZZO MECHANIC - Local 3 Marble & Tile**

**Effective Date - 08/01/2023**

| Step | percent | Apprentice Base Wage | Health  | Pension | Supplemental Unemployment | Total Rate |
|------|---------|----------------------|---------|---------|---------------------------|------------|
| 1    | 50      | \$31.21              | \$11.49 | \$22.31 | \$0.00                    | \$65.01    |
| 2    | 60      | \$37.45              | \$11.49 | \$22.31 | \$0.00                    | \$71.25    |
| 3    | 70      | \$43.69              | \$11.49 | \$22.31 | \$0.00                    | \$77.49    |
| 4    | 80      | \$49.94              | \$11.49 | \$22.31 | \$0.00                    | \$83.74    |
| 5    | 90      | \$56.18              | \$11.49 | \$22.31 | \$0.00                    | \$89.98    |

**Effective Date - 02/01/2024**

| Step | percent | Apprentice Base Wage | Health  | Pension | Supplemental Unemployment | Total Rate |
|------|---------|----------------------|---------|---------|---------------------------|------------|
| 1    | 50      | \$31.84              | \$11.49 | \$22.31 | \$0.00                    | \$65.64    |
| 2    | 60      | \$38.20              | \$11.49 | \$22.31 | \$0.00                    | \$72.00    |
| 3    | 70      | \$44.57              | \$11.49 | \$22.31 | \$0.00                    | \$78.37    |
| 4    | 80      | \$50.94              | \$11.49 | \$22.31 | \$0.00                    | \$84.74    |
| 5    | 90      | \$57.30              | \$11.49 | \$22.31 | \$0.00                    | \$91.10    |

**Notes:**

**Apprentice to Journeyworker Ratio:1:5**

|  |            |         |         |         |        |         |
|--|------------|---------|---------|---------|--------|---------|
| MECH. SWEEPER OPERATOR (ON CONST. SITES)<br><i>OPERATING ENGINEERS LOCAL 4</i> | 06/01/2023 | \$53.69 | \$14.75 | \$16.15 | \$0.00 | \$84.59 |
|  | 12/01/2023 | \$54.93 | \$14.75 | \$16.15 | \$0.00 | \$85.83 |
|  | 06/01/2024 | \$56.21 | \$14.75 | \$16.15 | \$0.00 | \$87.11 |
|  | 12/01/2024 | \$57.65 | \$14.75 | \$16.15 | \$0.00 | \$88.55 |
|  | 06/01/2025 | \$58.93 | \$14.75 | \$16.15 | \$0.00 | \$89.83 |
|  | 12/01/2025 | \$60.37 | \$14.75 | \$16.15 | \$0.00 | \$91.27 |
|  | 06/01/2026 | \$61.65 | \$14.75 | \$16.15 | \$0.00 | \$92.55 |
|  | 12/01/2026 | \$63.09 | \$14.75 | \$16.15 | \$0.00 | \$93.99 |

For apprentice rates see "Apprentice- OPERATING ENGINEERS"

| Classification  | Effective Date | Base Wage | Health  | Pension | Supplemental Unemployment | Total Rate |
|---|----------------|-----------|---------|---------|---------------------------|------------|
| MECHANICS MAINTENANCE<br><i>OPERATING ENGINEERS LOCAL 4</i> | 06/01/2023     | \$53.69   | \$14.75 | \$16.15 | \$0.00                    | \$84.59    |
|   | 12/01/2023     | \$54.93   | \$14.75 | \$16.15 | \$0.00                    | \$85.83    |
|   | 06/01/2024     | \$56.21   | \$14.75 | \$16.15 | \$0.00                    | \$87.11    |
|   | 12/01/2024     | \$57.65   | \$14.75 | \$16.15 | \$0.00                    | \$88.55    |
|   | 06/01/2025     | \$58.93   | \$14.75 | \$16.15 | \$0.00                    | \$89.83    |
|   | 12/01/2025     | \$60.37   | \$14.75 | \$16.15 | \$0.00                    | \$91.27    |
|   | 06/01/2026     | \$61.65   | \$14.75 | \$16.15 | \$0.00                    | \$92.55    |
|   | 12/01/2026     | \$63.09   | \$14.75 | \$16.15 | \$0.00                    | \$93.99    |

For apprentice rates see "Apprentice- OPERATING ENGINEERS"

|   |            |         |        |         |        |         |
|---|------------|---------|--------|---------|--------|---------|
| MILLWRIGHT (Zone 3)<br><i>MILLWRIGHTS LOCAL 1121 - Zone 3</i> | 01/02/2023 | \$40.16 | \$8.58 | \$21.57 | \$0.00 | \$70.31 |
|---|------------|---------|--------|---------|--------|---------|

**Apprentice - MILLWRIGHT - Local 1121 Zone 3**

**Effective Date - 01/02/2023**

| Step | percent | Apprentice Base Wage | Health | Pension | Supplemental Unemployment | Total Rate |
|------|---------|----------------------|--------|---------|---------------------------|------------|
| 1    | 55      | \$22.09              | \$8.58 | \$5.72  | \$0.00                    | \$36.39    |
| 2    | 65      | \$26.10              | \$8.58 | \$17.93 | \$0.00                    | \$52.61    |
| 3    | 75      | \$30.12              | \$8.58 | \$18.98 | \$0.00                    | \$57.68    |
| 4    | 85      | \$34.14              | \$8.58 | \$20.01 | \$0.00                    | \$62.73    |

**Notes:** Step 1&2 Appr. indentured after 1/6/2020 receive no pension, but do receive annuity. (Step 1 \$5.72, Step 2 \$6.66)  
Steps are 2,000 hours

**Apprentice to Journeyworker Ratio:1:4**

|  |            |         |        |         |        |         |
|--|------------|---------|--------|---------|--------|---------|
| MORTAR MIXER<br><i>LABORERS - ZONE 2</i> | 06/01/2023 | \$37.71 | \$9.40 | \$16.89 | \$0.00 | \$64.00 |
|  | 12/01/2023 | \$38.61 | \$9.40 | \$16.89 | \$0.00 | \$64.90 |

For apprentice rates see "Apprentice- LABORER"

|  |            |         |         |         |        |         |
|--|------------|---------|---------|---------|--------|---------|
| OILER (OTHER THAN TRUCK CRANES,GRADALLS)<br><i>OPERATING ENGINEERS LOCAL 4</i> | 06/01/2023 | \$24.34 | \$14.75 | \$16.15 | \$0.00 | \$55.24 |
|  | 12/01/2023 | \$24.91 | \$14.75 | \$16.15 | \$0.00 | \$55.81 |
|  | 06/01/2024 | \$25.51 | \$14.75 | \$16.15 | \$0.00 | \$56.41 |
|  | 12/01/2024 | \$26.17 | \$14.75 | \$16.15 | \$0.00 | \$57.07 |
|  | 06/01/2025 | \$26.77 | \$14.75 | \$16.15 | \$0.00 | \$57.67 |
|  | 12/01/2025 | \$27.43 | \$14.75 | \$16.15 | \$0.00 | \$58.33 |
|  | 06/01/2026 | \$28.02 | \$14.75 | \$16.15 | \$0.00 | \$58.92 |
|  | 12/01/2026 | \$28.69 | \$14.75 | \$16.15 | \$0.00 | \$59.59 |

For apprentice rates see "Apprentice- OPERATING ENGINEERS"

|  |            |         |         |         |        |         |
|--|------------|---------|---------|---------|--------|---------|
| OILER (TRUCK CRANES, GRADALLS)<br><i>OPERATING ENGINEERS LOCAL 4</i> | 06/01/2023 | \$29.67 | \$14.75 | \$16.15 | \$0.00 | \$60.57 |
|  | 12/01/2023 | \$30.36 | \$14.75 | \$16.15 | \$0.00 | \$61.26 |
|  | 06/01/2024 | \$31.08 | \$14.75 | \$16.15 | \$0.00 | \$61.98 |
|  | 12/01/2024 | \$31.88 | \$14.75 | \$16.15 | \$0.00 | \$62.78 |
|  | 06/01/2025 | \$32.60 | \$14.75 | \$16.15 | \$0.00 | \$63.50 |
|  | 12/01/2025 | \$33.40 | \$14.75 | \$16.15 | \$0.00 | \$64.30 |
|  | 06/01/2026 | \$34.12 | \$14.75 | \$16.15 | \$0.00 | \$65.02 |
|  | 12/01/2026 | \$34.92 | \$14.75 | \$16.15 | \$0.00 | \$65.82 |

For apprentice rates see "Apprentice- OPERATING ENGINEERS"



| Classification  | Effective Date | Base Wage | Health  | Pension | Supplemental Unemployment | Total Rate |
|---|----------------|-----------|---------|---------|---------------------------|------------|
| OTHER POWER DRIVEN EQUIPMENT - CLASS II<br><i>OPERATING ENGINEERS LOCAL 4</i> | 06/01/2023     | \$53.69   | \$14.75 | \$16.15 | \$0.00                    | \$84.59    |
|   | 12/01/2023     | \$54.93   | \$14.75 | \$16.15 | \$0.00                    | \$85.83    |
|   | 06/01/2024     | \$56.21   | \$14.75 | \$16.15 | \$0.00                    | \$87.11    |
|   | 12/01/2024     | \$57.65   | \$14.75 | \$16.15 | \$0.00                    | \$88.55    |
|   | 06/01/2025     | \$58.93   | \$14.75 | \$16.15 | \$0.00                    | \$89.83    |
|   | 12/01/2025     | \$60.37   | \$14.75 | \$16.15 | \$0.00                    | \$91.27    |
|   | 06/01/2026     | \$61.65   | \$14.75 | \$16.15 | \$0.00                    | \$92.55    |
|   | 12/01/2026     | \$63.09   | \$14.75 | \$16.15 | \$0.00                    | \$93.99    |

For apprentice rates see "Apprentice- OPERATING ENGINEERS"

|  |            |         |        |         |        |         |
|--|------------|---------|--------|---------|--------|---------|
| PAINTER (BRIDGES/TANKS)<br><i>PAINTERS LOCAL 35 - ZONE 2</i> | 07/01/2023 | \$55.51 | \$9.65 | \$23.70 | \$0.00 | \$88.86 |
|  | 01/01/2024 | \$56.06 | \$9.95 | \$23.95 | \$0.00 | \$89.96 |
|  | 07/01/2024 | \$57.26 | \$9.95 | \$23.95 | \$0.00 | \$91.16 |
|  | 01/01/2025 | \$58.46 | \$9.95 | \$23.95 | \$0.00 | \$92.36 |

**Apprentice - PAINTER Local 35 - BRIDGES/TANKS**

**Effective Date - 07/01/2023**

| Step | percent | Apprentice Base Wage | Health | Pension | Supplemental Unemployment | Total Rate |
|------|---------|----------------------|--------|---------|---------------------------|------------|
| 1    | 50      | \$27.76              | \$9.65 | \$0.00  | \$0.00                    | \$37.41    |
| 2    | 55      | \$30.53              | \$9.65 | \$6.55  | \$0.00                    | \$46.73    |
| 3    | 60      | \$33.31              | \$9.65 | \$7.14  | \$0.00                    | \$50.10    |
| 4    | 65      | \$36.08              | \$9.65 | \$7.74  | \$0.00                    | \$53.47    |
| 5    | 70      | \$38.86              | \$9.65 | \$20.13 | \$0.00                    | \$68.64    |
| 6    | 75      | \$41.63              | \$9.65 | \$20.73 | \$0.00                    | \$72.01    |
| 7    | 80      | \$44.41              | \$9.65 | \$21.32 | \$0.00                    | \$75.38    |
| 8    | 90      | \$49.96              | \$9.65 | \$22.51 | \$0.00                    | \$82.12    |

**Effective Date - 01/01/2024**

| Step | percent | Apprentice Base Wage | Health | Pension | Supplemental Unemployment | Total Rate |
|------|---------|----------------------|--------|---------|---------------------------|------------|
| 1    | 50      | \$28.03              | \$9.95 | \$0.00  | \$0.00                    | \$37.98    |
| 2    | 55      | \$30.83              | \$9.95 | \$6.66  | \$0.00                    | \$47.44    |
| 3    | 60      | \$33.64              | \$9.95 | \$7.26  | \$0.00                    | \$50.85    |
| 4    | 65      | \$36.44              | \$9.95 | \$7.87  | \$0.00                    | \$54.26    |
| 5    | 70      | \$39.24              | \$9.95 | \$20.32 | \$0.00                    | \$69.51    |
| 6    | 75      | \$42.05              | \$9.95 | \$20.93 | \$0.00                    | \$72.93    |
| 7    | 80      | \$44.85              | \$9.95 | \$21.53 | \$0.00                    | \$76.33    |
| 8    | 90      | \$50.45              | \$9.95 | \$22.74 | \$0.00                    | \$83.14    |

**Notes:**

Steps are 750 hrs.

**Apprentice to Journeyworker Ratio:1:1**

|  |            |         |        |         |        |         |
|--|------------|---------|--------|---------|--------|---------|
| PAINTER (SPRAY OR SANDBLAST, NEW) *<br>* If 30% or more of surfaces to be painted are new construction,<br>NEW paint rate shall be used. <i>PAINTERS LOCAL 35 - ZONE 2</i> | 07/01/2023 | \$46.41 | \$9.65 | \$23.70 | \$0.00 | \$79.76 |
|  | 01/01/2024 | \$46.96 | \$9.95 | \$23.95 | \$0.00 | \$80.86 |
|  | 07/01/2024 | \$48.16 | \$9.95 | \$23.95 | \$0.00 | \$82.06 |
|  | 01/01/2025 | \$49.36 | \$9.95 | \$23.95 | \$0.00 | \$83.26 |

**Classification**

**Effective Date    Base Wage    Health    Pension    Supplemental Unemployment    Total Rate**

**Apprentice - PAINTER Local 35 Zone 2 - Spray/Sandblast - New**

**Effective Date - 07/01/2023**

| Step | percent | Apprentice Base Wage | Health | Pension | Supplemental Unemployment | Total Rate |
|------|---------|----------------------|--------|---------|---------------------------|------------|
| 1    | 50      | \$23.21              | \$9.65 | \$0.00  | \$0.00                    | \$32.86    |
| 2    | 55      | \$25.53              | \$9.65 | \$6.55  | \$0.00                    | \$41.73    |
| 3    | 60      | \$27.85              | \$9.65 | \$7.14  | \$0.00                    | \$44.64    |
| 4    | 65      | \$30.17              | \$9.65 | \$7.74  | \$0.00                    | \$47.56    |
| 5    | 70      | \$32.49              | \$9.65 | \$20.13 | \$0.00                    | \$62.27    |
| 6    | 75      | \$34.81              | \$9.65 | \$20.73 | \$0.00                    | \$65.19    |
| 7    | 80      | \$37.13              | \$9.65 | \$21.32 | \$0.00                    | \$68.10    |
| 8    | 90      | \$41.77              | \$8.65 | \$22.51 | \$0.00                    | \$72.93    |

**Effective Date - 01/01/2024**

| Step | percent | Apprentice Base Wage | Health | Pension | Supplemental Unemployment | Total Rate |
|------|---------|----------------------|--------|---------|---------------------------|------------|
| 1    | 50      | \$23.48              | \$9.95 | \$0.00  | \$0.00                    | \$33.43    |
| 2    | 55      | \$25.83              | \$9.95 | \$6.66  | \$0.00                    | \$42.44    |
| 3    | 60      | \$28.18              | \$9.95 | \$7.26  | \$0.00                    | \$45.39    |
| 4    | 65      | \$30.52              | \$9.95 | \$7.87  | \$0.00                    | \$48.34    |
| 5    | 70      | \$32.87              | \$9.95 | \$20.32 | \$0.00                    | \$63.14    |
| 6    | 75      | \$35.22              | \$9.95 | \$20.93 | \$0.00                    | \$66.10    |
| 7    | 80      | \$37.57              | \$9.95 | \$21.53 | \$0.00                    | \$69.05    |
| 8    | 90      | \$42.26              | \$9.95 | \$22.74 | \$0.00                    | \$74.95    |

**Notes:**

Steps are 750 hrs.

**Apprentice to Journeyworker Ratio:1:1**

|                                       |            |         |        |         |        |         |
|---------------------------------------|------------|---------|--------|---------|--------|---------|
| PAINTER (SPRAY OR SANDBLAST, REPAINT) | 07/01/2023 | \$44.47 | \$9.65 | \$23.70 | \$0.00 | \$77.82 |
| PAINTERS LOCAL 35 - ZONE 2            | 01/01/2024 | \$45.02 | \$9.95 | \$23.95 | \$0.00 | \$78.92 |
|                                       | 07/01/2024 | \$46.22 | \$9.95 | \$23.95 | \$0.00 | \$80.12 |
|                                       | 01/01/2025 | \$47.42 | \$9.95 | \$23.95 | \$0.00 | \$81.32 |

**Classification**

**Effective Date    Base Wage    Health    Pension    Supplemental Unemployment    Total Rate**

**Apprentice - PAINTER Local 35 Zone 2 - Spray/Sandblast - Repaint**

**Effective Date - 07/01/2023**

| Step | percent | Apprentice Base Wage | Health | Pension | Supplemental Unemployment | Total Rate |
|------|---------|----------------------|--------|---------|---------------------------|------------|
| 1    | 50      | \$22.24              | \$9.65 | \$0.00  | \$0.00                    | \$31.89    |
| 2    | 55      | \$24.46              | \$9.65 | \$6.55  | \$0.00                    | \$40.66    |
| 3    | 60      | \$26.68              | \$9.65 | \$7.14  | \$0.00                    | \$43.47    |
| 4    | 65      | \$28.91              | \$9.65 | \$7.74  | \$0.00                    | \$46.30    |
| 5    | 70      | \$31.13              | \$9.65 | \$20.13 | \$0.00                    | \$60.91    |
| 6    | 75      | \$33.35              | \$9.65 | \$20.73 | \$0.00                    | \$63.73    |
| 7    | 80      | \$35.58              | \$9.65 | \$21.32 | \$0.00                    | \$66.55    |
| 8    | 90      | \$40.02              | \$9.65 | \$22.51 | \$0.00                    | \$72.18    |

**Effective Date - 01/01/2024**

| Step | percent | Apprentice Base Wage | Health | Pension | Supplemental Unemployment | Total Rate |
|------|---------|----------------------|--------|---------|---------------------------|------------|
| 1    | 50      | \$22.51              | \$9.95 | \$0.00  | \$0.00                    | \$32.46    |
| 2    | 55      | \$24.76              | \$9.95 | \$6.66  | \$0.00                    | \$41.37    |
| 3    | 60      | \$27.01              | \$9.95 | \$7.26  | \$0.00                    | \$44.22    |
| 4    | 65      | \$29.26              | \$9.95 | \$7.87  | \$0.00                    | \$47.08    |
| 5    | 70      | \$31.51              | \$9.95 | \$20.32 | \$0.00                    | \$61.78    |
| 6    | 75      | \$33.77              | \$9.95 | \$20.93 | \$0.00                    | \$64.65    |
| 7    | 80      | \$36.02              | \$9.95 | \$21.53 | \$0.00                    | \$67.50    |
| 8    | 90      | \$40.52              | \$9.95 | \$22.74 | \$0.00                    | \$73.21    |

**Notes:**

Steps are 750 hrs.

**Apprentice to Journeyworker Ratio:1:1**

|   |            |         |        |         |        |         |
|---|------------|---------|--------|---------|--------|---------|
| PAINTER / TAPER (BRUSH, NEW) *  | 07/01/2023 | \$45.01 | \$9.65 | \$23.70 | \$0.00 | \$78.36 |
| * If 30% or more of surfaces to be painted are new construction,<br>NEW paint rate shall be used. <i>PAINTERS LOCAL 35 - ZONE 2</i> | 01/01/2024 | \$45.56 | \$9.95 | \$23.95 | \$0.00 | \$79.46 |
|   | 07/01/2024 | \$46.76 | \$9.95 | \$23.95 | \$0.00 | \$80.66 |
|   | 01/01/2025 | \$47.96 | \$9.95 | \$23.95 | \$0.00 | \$81.86 |

**Classification**

**Effective Date    Base Wage    Health    Pension    Supplemental Unemployment    Total Rate**

**Apprentice - PAINTER - Local 35 Zone 2 - BRUSH NEW**

**Effective Date - 07/01/2023**

| Step | percent | Apprentice Base Wage | Health | Pension | Supplemental Unemployment | Total Rate |
|------|---------|----------------------|--------|---------|---------------------------|------------|
| 1    | 50      | \$22.51              | \$9.65 | \$0.00  | \$0.00                    | \$32.16    |
| 2    | 55      | \$24.76              | \$9.65 | \$6.55  | \$0.00                    | \$40.96    |
| 3    | 60      | \$27.01              | \$9.65 | \$7.14  | \$0.00                    | \$43.80    |
| 4    | 65      | \$29.26              | \$9.65 | \$7.74  | \$0.00                    | \$46.65    |
| 5    | 70      | \$31.51              | \$9.65 | \$20.13 | \$0.00                    | \$61.29    |
| 6    | 75      | \$33.76              | \$9.65 | \$20.73 | \$0.00                    | \$64.14    |
| 7    | 80      | \$36.01              | \$9.65 | \$21.32 | \$0.00                    | \$66.98    |
| 8    | 90      | \$40.51              | \$9.65 | \$22.51 | \$0.00                    | \$72.67    |

**Effective Date - 01/01/2024**

| Step | percent | Apprentice Base Wage | Health | Pension | Supplemental Unemployment | Total Rate |
|------|---------|----------------------|--------|---------|---------------------------|------------|
| 1    | 50      | \$22.78              | \$9.95 | \$0.00  | \$0.00                    | \$32.73    |
| 2    | 55      | \$25.06              | \$9.95 | \$6.66  | \$0.00                    | \$41.67    |
| 3    | 60      | \$27.34              | \$9.95 | \$7.26  | \$0.00                    | \$44.55    |
| 4    | 65      | \$29.61              | \$9.95 | \$7.87  | \$0.00                    | \$47.43    |
| 5    | 70      | \$31.89              | \$9.95 | \$20.32 | \$0.00                    | \$62.16    |
| 6    | 75      | \$34.17              | \$9.95 | \$20.93 | \$0.00                    | \$65.05    |
| 7    | 80      | \$36.45              | \$9.95 | \$21.53 | \$0.00                    | \$67.93    |
| 8    | 90      | \$41.00              | \$9.95 | \$22.74 | \$0.00                    | \$73.69    |

**Notes:**

Steps are 750 hrs.

**Apprentice to Journeyworker Ratio:1:1**

|                                  |            |         |        |         |        |         |
|----------------------------------|------------|---------|--------|---------|--------|---------|
| PAINTER / TAPER (BRUSH, REPAINT) | 07/01/2023 | \$43.07 | \$9.65 | \$23.70 | \$0.00 | \$76.42 |
| PAINTERS LOCAL 35 - ZONE 2       | 01/01/2024 | \$43.62 | \$9.95 | \$23.95 | \$0.00 | \$77.52 |
|                                  | 07/01/2024 | \$44.82 | \$9.95 | \$23.95 | \$0.00 | \$78.72 |
|                                  | 01/01/2025 | \$46.02 | \$9.95 | \$23.95 | \$0.00 | \$79.92 |

**Classification**

**Effective Date   Base Wage   Health   Pension   Supplemental Unemployment   Total Rate**

**Apprentice - PAINTER Local 35 Zone 2 - BRUSH REPAINT**

**Effective Date - 07/01/2023**

| Step | percent | Apprentice Base Wage | Health | Pension | Supplemental Unemployment | Total Rate |
|------|---------|----------------------|--------|---------|---------------------------|------------|
| 1    | 50      | \$21.54              | \$9.65 | \$0.00  | \$0.00                    | \$31.19    |
| 2    | 55      | \$23.69              | \$9.65 | \$6.27  | \$0.00                    | \$39.61    |
| 3    | 60      | \$25.84              | \$9.65 | \$6.84  | \$0.00                    | \$42.33    |
| 4    | 65      | \$28.00              | \$9.65 | \$7.41  | \$0.00                    | \$45.06    |
| 5    | 70      | \$30.15              | \$9.65 | \$19.78 | \$0.00                    | \$59.58    |
| 6    | 75      | \$32.30              | \$9.65 | \$20.35 | \$0.00                    | \$62.30    |
| 7    | 80      | \$34.46              | \$9.65 | \$20.92 | \$0.00                    | \$65.03    |
| 8    | 90      | \$38.76              | \$9.65 | \$22.06 | \$0.00                    | \$70.47    |

**Effective Date - 01/01/2024**

| Step | percent | Apprentice Base Wage | Health | Pension | Supplemental Unemployment | Total Rate |
|------|---------|----------------------|--------|---------|---------------------------|------------|
| 1    | 50      | \$21.81              | \$9.95 | \$0.00  | \$0.00                    | \$31.76    |
| 2    | 55      | \$23.99              | \$9.95 | \$6.66  | \$0.00                    | \$40.60    |
| 3    | 60      | \$26.17              | \$9.95 | \$7.26  | \$0.00                    | \$43.38    |
| 4    | 65      | \$28.35              | \$9.95 | \$7.87  | \$0.00                    | \$46.17    |
| 5    | 70      | \$30.53              | \$9.95 | \$20.32 | \$0.00                    | \$60.80    |
| 6    | 75      | \$32.72              | \$9.95 | \$20.93 | \$0.00                    | \$63.60    |
| 7    | 80      | \$34.90              | \$9.95 | \$21.53 | \$0.00                    | \$66.38    |
| 8    | 90      | \$39.26              | \$9.95 | \$22.74 | \$0.00                    | \$71.95    |

**Notes:**  
Steps are 750 hrs.

**Apprentice to Journeyworker Ratio:1:1**

|  |            |         |        |         |        |         |
|--|------------|---------|--------|---------|--------|---------|
| PAINTER TRAFFIC MARKINGS (HEAVY/HIGHWAY) | 06/01/2023 | \$37.46 | \$9.40 | \$16.89 | \$0.00 | \$63.75 |
| LABORERS - ZONE 2 (HEAVY & HIGHWAY)      | 12/01/2023 | \$38.36 | \$9.40 | \$16.89 | \$0.00 | \$64.65 |
|  | 06/01/2024 | \$39.69 | \$9.40 | \$16.89 | \$0.00 | \$65.98 |
|  | 12/01/2024 | \$41.02 | \$9.40 | \$16.89 | \$0.00 | \$67.31 |
|  | 06/01/2025 | \$42.41 | \$9.40 | \$16.89 | \$0.00 | \$68.70 |
|  | 12/01/2025 | \$43.79 | \$9.40 | \$16.89 | \$0.00 | \$70.08 |
|  | 06/01/2026 | \$45.23 | \$9.40 | \$16.89 | \$0.00 | \$71.52 |
|  | 12/01/2026 | \$46.67 | \$9.40 | \$16.89 | \$0.00 | \$72.96 |

For apprentice rates see "Apprentice- LABORER (Heavy and Highway)

| Classification  | Effective Date | Base Wage | Health  | Pension | Supplemental Unemployment | Total Rate |
|---|----------------|-----------|---------|---------|---------------------------|------------|
| PANEL & PICKUP TRUCKS DRIVER<br><i>TEAMSTERS JOINT COUNCIL NO. 10 ZONE B</i>  | 06/01/2023     | \$38.78   | \$14.57 | \$17.29 | \$0.00                    | \$70.64    |
|   | 12/01/2023     | \$38.78   | \$14.57 | \$18.67 | \$0.00                    | \$72.02    |
|   | 01/01/2024     | \$38.78   | \$15.07 | \$18.67 | \$0.00                    | \$72.52    |
|   | 06/01/2024     | \$39.78   | \$15.07 | \$18.67 | \$0.00                    | \$73.52    |
|   | 12/01/2024     | \$39.78   | \$15.07 | \$20.17 | \$0.00                    | \$75.02    |
|   | 01/01/2025     | \$39.78   | \$15.57 | \$20.17 | \$0.00                    | \$75.52    |
|   | 06/01/2025     | \$40.78   | \$15.57 | \$20.17 | \$0.00                    | \$76.52    |
|   | 12/01/2025     | \$40.78   | \$15.57 | \$21.78 | \$0.00                    | \$78.13    |
|   | 01/01/2026     | \$40.78   | \$16.17 | \$21.78 | \$0.00                    | \$78.73    |
|   | 06/01/2026     | \$41.78   | \$16.17 | \$21.78 | \$0.00                    | \$79.73    |
| PIER AND DOCK CONSTRUCTOR (UNDERPINNING AND DECK)<br><i>PILE DRIVER LOCAL 56 (ZONE 2)</i><br>For apprentice rates see "Apprentice- PILE DRIVER" | 08/01/2020     | \$46.11   | \$9.40  | \$23.12 | \$0.00                    | \$78.63    |
|   | 08/01/2020     | \$46.11   | \$9.40  | \$23.12 | \$0.00                    | \$78.63    |

**Apprentice - PILE DRIVER - Local 56 Zone 2**

**Effective Date - 08/01/2020**

| Step | percent | Apprentice Base Wage | Health | Pension | Supplemental Unemployment | Total Rate |
|------|---------|----------------------|--------|---------|---------------------------|------------|
| 1    | 0       | \$0.00               | \$0.00 | \$0.00  | \$0.00                    | \$0.00     |

**Notes:** Apprentice wages shall be no less than the following Steps;  
(Same as set in Zone 1)  
1\$57.06/2\$61.96/3\$66.87/4\$69.32/5\$71.78/6\$71.78/7\$76.68/8\$76.68

**Apprentice to Journeyworker Ratio:1:5**

|   |            |         |         |         |        |         |
|---|------------|---------|---------|---------|--------|---------|
| PIPELAYER<br><i>LABORERS - ZONE 2</i><br>For apprentice rates see "Apprentice- LABORER"   | 06/01/2023 | \$37.71 | \$9.40  | \$16.89 | \$0.00 | \$64.00 |
|   | 12/01/2023 | \$38.61 | \$9.40  | \$16.89 | \$0.00 | \$64.90 |
| PIPELAYER (HEAVY & HIGHWAY)<br><i>LABORERS - ZONE 2 (HEAVY &amp; HIGHWAY)</i><br>For apprentice rates see "Apprentice- LABORER (Heavy and Highway)" | 06/01/2023 | \$37.71 | \$9.40  | \$16.89 | \$0.00 | \$64.00 |
|   | 12/01/2023 | \$38.61 | \$9.40  | \$16.89 | \$0.00 | \$64.90 |
|   | 06/01/2024 | \$39.94 | \$9.40  | \$16.89 | \$0.00 | \$66.23 |
|   | 12/01/2024 | \$41.27 | \$9.40  | \$16.89 | \$0.00 | \$67.56 |
|   | 06/01/2025 | \$42.66 | \$9.40  | \$16.89 | \$0.00 | \$68.95 |
|   | 12/01/2025 | \$44.04 | \$9.40  | \$16.89 | \$0.00 | \$70.33 |
|   | 06/01/2026 | \$45.48 | \$9.40  | \$16.89 | \$0.00 | \$71.77 |
|   | 12/01/2026 | \$46.92 | \$9.40  | \$16.89 | \$0.00 | \$73.21 |
| PLUMBER & PIPEFITTER<br><i>PLUMBERS LOCAL 4</i>   | 09/01/2023 | \$52.55 | \$19.80 | \$17.42 | \$0.00 | \$89.77 |
|   | 03/01/2024 | \$53.95 | \$19.80 | \$17.42 | \$0.00 | \$91.17 |
|   | 09/01/2024 | \$55.35 | \$19.80 | \$17.42 | \$0.00 | \$92.57 |
|   | 03/01/2025 | \$56.75 | \$19.80 | \$17.42 | \$0.00 | \$93.97 |
|   | 09/01/2025 | \$58.15 | \$19.80 | \$17.42 | \$0.00 | \$95.37 |
|   | 03/01/2026 | \$59.55 | \$19.80 | \$17.42 | \$0.00 | \$96.77 |

|                       |                       |                  |               |                |                                  |                   |
|-----------------------|-----------------------|------------------|---------------|----------------|----------------------------------|-------------------|
| <b>Classification</b> | <b>Effective Date</b> | <b>Base Wage</b> | <b>Health</b> | <b>Pension</b> | <b>Supplemental Unemployment</b> | <b>Total Rate</b> |
|-----------------------|-----------------------|------------------|---------------|----------------|----------------------------------|-------------------|

**Apprentice - PLUMBER/PIPEFITTER - Local 4**

**Effective Date - 09/01/2023**

| Step | percent | Apprentice Base Wage | Health | Pension | Supplemental Unemployment | Total Rate |
|------|---------|----------------------|--------|---------|---------------------------|------------|
| 1    | 40      | \$21.02              | \$9.80 | \$0.00  | \$0.00                    | \$30.82    |
| 2    | 50      | \$26.28              | \$9.80 | \$0.00  | \$0.00                    | \$36.08    |
| 3    | 60      | \$31.53              | \$9.80 | \$0.00  | \$0.00                    | \$41.33    |
| 4    | 70      | \$36.79              | \$9.80 | \$7.71  | \$0.00                    | \$54.30    |
| 5    | 80      | \$42.04              | \$9.80 | \$7.71  | \$0.00                    | \$59.55    |

**Effective Date - 03/01/2024**

| Step | percent | Apprentice Base Wage | Health | Pension | Supplemental Unemployment | Total Rate |
|------|---------|----------------------|--------|---------|---------------------------|------------|
| 1    | 40      | \$21.58              | \$9.80 | \$0.00  | \$0.00                    | \$31.38    |
| 2    | 50      | \$26.98              | \$9.80 | \$0.00  | \$0.00                    | \$36.78    |
| 3    | 60      | \$32.37              | \$9.80 | \$0.00  | \$0.00                    | \$42.17    |
| 4    | 70      | \$37.77              | \$9.80 | \$7.71  | \$0.00                    | \$55.28    |
| 5    | 80      | \$43.16              | \$9.80 | \$7.71  | \$0.00                    | \$60.67    |

**Notes:**

Steps - 2000 hrs; Step 4 w/lic 75%, Step 5 w/lic 85%  
 Step 4 w/lic \$52.59, Step 5 w/lic \$57.44

**Apprentice to Journeyworker Ratio:1:3**

|   |            |         |        |         |        |         |
|---|------------|---------|--------|---------|--------|---------|
| PNEUMATIC CONTROLS (TEMP.)<br><i>PLUMBERS LOCAL 4</i> | 09/01/2023 | \$52.55 | \$9.90 | \$17.42 | \$0.00 | \$79.87 |
|   | 03/01/2024 | \$53.95 | \$9.90 | \$17.42 | \$0.00 | \$81.27 |
|   | 09/01/2024 | \$55.35 | \$9.90 | \$17.42 | \$0.00 | \$82.67 |
|   | 03/01/2025 | \$56.75 | \$9.90 | \$17.42 | \$0.00 | \$84.07 |
|   | 09/01/2025 | \$58.15 | \$9.90 | \$17.42 | \$0.00 | \$85.47 |
|   | 03/01/2026 | \$59.55 | \$9.90 | \$17.42 | \$0.00 | \$86.87 |

For apprentice rates see "Apprentice- PIPEFITTER" or "PLUMBER/PIPEFITTER"

|   |            |         |        |         |        |         |
|---|------------|---------|--------|---------|--------|---------|
| PNEUMATIC DRILL/TOOL OPERATOR<br><i>LABORERS - ZONE 2</i> | 06/01/2023 | \$37.71 | \$9.40 | \$16.89 | \$0.00 | \$64.00 |
|   | 12/01/2023 | \$38.61 | \$9.40 | \$16.89 | \$0.00 | \$64.90 |

For apprentice rates see "Apprentice- LABORER"

|   |            |         |        |         |        |         |
|---|------------|---------|--------|---------|--------|---------|
| PNEUMATIC DRILL/TOOL OPERATOR (HEAVY & HIGHWAY)<br><i>LABORERS - ZONE 2 (HEAVY &amp; HIGHWAY)</i> | 06/01/2023 | \$37.71 | \$9.40 | \$16.89 | \$0.00 | \$64.00 |
|   | 12/01/2023 | \$38.61 | \$9.40 | \$16.89 | \$0.00 | \$64.90 |
|   | 06/01/2024 | \$39.94 | \$9.40 | \$16.89 | \$0.00 | \$66.23 |
|   | 12/01/2024 | \$41.27 | \$9.40 | \$16.89 | \$0.00 | \$67.56 |
|   | 06/01/2025 | \$42.66 | \$9.40 | \$16.89 | \$0.00 | \$68.95 |
|   | 12/01/2025 | \$44.04 | \$9.40 | \$16.89 | \$0.00 | \$70.33 |
|   | 06/01/2026 | \$45.48 | \$9.40 | \$16.89 | \$0.00 | \$71.77 |
|   | 12/01/2026 | \$46.92 | \$9.40 | \$16.89 | \$0.00 | \$73.21 |

For apprentice rates see "Apprentice- LABORER (Heavy and Highway)"

|   |            |         |        |         |        |         |
|---|------------|---------|--------|---------|--------|---------|
| POWDERMAN & BLASTER<br><i>LABORERS - ZONE 2</i> | 06/01/2023 | \$38.46 | \$9.40 | \$16.89 | \$0.00 | \$64.75 |
|   | 12/01/2023 | \$39.36 | \$9.40 | \$16.89 | \$0.00 | \$65.65 |

For apprentice rates see "Apprentice- LABORER"

| Classification  | Effective Date | Base Wage | Health  | Pension | Supplemental Unemployment | Total Rate |
|---|----------------|-----------|---------|---------|---------------------------|------------|
| POWDERMAN & BLASTER (HEAVY & HIGHWAY)<br><i>LABORERS - ZONE 2 (HEAVY &amp; HIGHWAY)</i> | 06/01/2023     | \$38.46   | \$9.40  | \$16.89 | \$0.00                    | \$64.75    |
|   | 12/01/2023     | \$39.36   | \$9.40  | \$16.89 | \$0.00                    | \$65.65    |
|   | 06/01/2024     | \$40.69   | \$9.40  | \$16.89 | \$0.00                    | \$66.98    |
|   | 12/01/2024     | \$42.02   | \$9.40  | \$16.89 | \$0.00                    | \$68.31    |
|   | 06/01/2025     | \$43.41   | \$9.40  | \$16.89 | \$0.00                    | \$69.70    |
|   | 12/01/2025     | \$44.79   | \$9.40  | \$16.89 | \$0.00                    | \$71.08    |
|   | 06/01/2026     | \$46.23   | \$9.40  | \$16.89 | \$0.00                    | \$72.52    |
|   | 12/01/2026     | \$47.67   | \$9.40  | \$16.89 | \$0.00                    | \$73.96    |
| For apprentice rates see "Apprentice- LABORER (Heavy and Highway)                       |                |           |         |         |                           |            |
| POWER SHOVEL/DERRICK/TRENCHING MACHINE<br><i>OPERATING ENGINEERS LOCAL 4</i>            | 06/01/2023     | \$54.28   | \$14.75 | \$16.15 | \$0.00                    | \$85.18    |
|   | 12/01/2023     | \$55.53   | \$14.75 | \$16.15 | \$0.00                    | \$86.43    |
|   | 06/01/2024     | \$56.83   | \$14.75 | \$16.15 | \$0.00                    | \$87.73    |
|   | 12/01/2024     | \$58.28   | \$14.75 | \$16.15 | \$0.00                    | \$89.18    |
|   | 06/01/2025     | \$59.58   | \$14.75 | \$16.15 | \$0.00                    | \$90.48    |
|   | 12/01/2025     | \$61.03   | \$14.75 | \$16.15 | \$0.00                    | \$91.93    |
|   | 06/01/2026     | \$62.33   | \$14.75 | \$16.15 | \$0.00                    | \$93.23    |
|   | 12/01/2026     | \$63.78   | \$14.75 | \$16.15 | \$0.00                    | \$94.68    |
| For apprentice rates see "Apprentice- OPERATING ENGINEERS"                              |                |           |         |         |                           |            |
| PUMP OPERATOR (CONCRETE)<br><i>OPERATING ENGINEERS LOCAL 4</i>                          | 06/01/2023     | \$54.28   | \$14.75 | \$16.15 | \$0.00                    | \$85.18    |
|   | 12/01/2023     | \$55.53   | \$14.75 | \$16.15 | \$0.00                    | \$86.43    |
|   | 06/01/2024     | \$56.83   | \$14.75 | \$16.15 | \$0.00                    | \$87.73    |
|   | 12/01/2024     | \$58.28   | \$14.75 | \$16.15 | \$0.00                    | \$89.18    |
|   | 06/01/2025     | \$59.58   | \$14.75 | \$16.15 | \$0.00                    | \$90.48    |
|   | 12/01/2025     | \$61.03   | \$14.75 | \$16.15 | \$0.00                    | \$91.93    |
|   | 06/01/2026     | \$62.33   | \$14.75 | \$16.15 | \$0.00                    | \$93.23    |
|   | 12/01/2026     | \$63.78   | \$14.75 | \$16.15 | \$0.00                    | \$94.68    |
| For apprentice rates see "Apprentice- OPERATING ENGINEERS"                              |                |           |         |         |                           |            |
| PUMP OPERATOR (DEWATERING, OTHER)<br><i>OPERATING ENGINEERS LOCAL 4</i>                 | 06/01/2023     | \$35.30   | \$14.75 | \$16.15 | \$0.00                    | \$66.20    |
|   | 12/01/2023     | \$36.12   | \$14.75 | \$16.15 | \$0.00                    | \$67.02    |
|   | 06/01/2024     | \$36.97   | \$14.75 | \$16.15 | \$0.00                    | \$67.87    |
|   | 12/01/2024     | \$37.92   | \$14.75 | \$16.15 | \$0.00                    | \$68.82    |
|   | 06/01/2025     | \$38.77   | \$14.75 | \$16.15 | \$0.00                    | \$69.67    |
|   | 12/01/2025     | \$39.72   | \$14.75 | \$16.15 | \$0.00                    | \$70.62    |
|   | 06/01/2026     | \$40.58   | \$14.75 | \$16.15 | \$0.00                    | \$71.48    |
|   | 12/01/2026     | \$41.53   | \$14.75 | \$16.15 | \$0.00                    | \$72.43    |
| For apprentice rates see "Apprentice- OPERATING ENGINEERS"                              |                |           |         |         |                           |            |
| READY-MIX CONCRETE DRIVER<br><i>TEAMSTERS 170 -J.G.MacLellan (Lunenburg)</i>            | 02/02/2023     | \$25.29   | \$10.77 | \$8.00  | \$0.00                    | \$44.06    |
|   | 01/01/2024     | \$28.00   | \$11.17 | \$8.00  | \$0.00                    | \$47.17    |
|   | 02/02/2024     | \$29.00   | \$11.17 | \$8.00  | \$0.00                    | \$48.17    |
|   | 01/01/2025     | \$29.00   | \$11.57 | \$8.00  | \$0.00                    | \$48.57    |
|   | 02/02/2025     | \$29.50   | \$11.57 | \$8.00  | \$0.00                    | \$49.07    |
|   | 02/02/2026     | \$29.50   | \$12.37 | \$8.00  | \$0.00                    | \$49.87    |
|   | 01/01/2027     | \$30.00   | \$12.37 | \$8.00  | \$0.00                    | \$50.37    |



| Classification   | Effective Date | Base Wage | Health  | Pension | Supplemental Unemployment | Total Rate |
|--|----------------|-----------|---------|---------|---------------------------|------------|
| RECLAIMERS<br><i>OPERATING ENGINEERS LOCAL 4</i>                               | 06/01/2023     | \$53.69   | \$14.75 | \$16.15 | \$0.00                    | \$84.59    |
|  | 12/01/2023     | \$54.93   | \$14.75 | \$16.15 | \$0.00                    | \$85.83    |
|  | 06/01/2024     | \$56.21   | \$14.75 | \$16.15 | \$0.00                    | \$87.11    |
|  | 12/01/2024     | \$57.65   | \$14.75 | \$16.15 | \$0.00                    | \$88.55    |
|  | 06/01/2025     | \$58.93   | \$14.75 | \$16.15 | \$0.00                    | \$89.83    |
|  | 12/01/2025     | \$60.37   | \$14.75 | \$16.15 | \$0.00                    | \$91.27    |
|  | 06/01/2026     | \$61.65   | \$14.75 | \$16.15 | \$0.00                    | \$92.55    |
|  | 12/01/2026     | \$63.09   | \$14.75 | \$16.15 | \$0.00                    | \$93.99    |
| For apprentice rates see "Apprentice- OPERATING ENGINEERS"                     |                |           |         |         |                           |            |
| RIDE-ON MOTORIZED BUGGY OPERATOR<br><i>LABORERS - ZONE 2</i>                   | 06/01/2023     | \$37.71   | \$9.40  | \$16.89 | \$0.00                    | \$64.00    |
|  | 12/01/2023     | \$38.61   | \$9.40  | \$16.89 | \$0.00                    | \$64.90    |
| For apprentice rates see "Apprentice- LABORER"                                 |                |           |         |         |                           |            |
| ROLLER/SPREADER/MULCHING MACHINE<br><i>OPERATING ENGINEERS LOCAL 4</i>         | 06/01/2023     | \$53.69   | \$14.75 | \$16.15 | \$0.00                    | \$84.59    |
|  | 12/01/2023     | \$54.93   | \$14.75 | \$16.15 | \$0.00                    | \$85.83    |
|  | 06/01/2024     | \$56.21   | \$14.75 | \$16.15 | \$0.00                    | \$87.11    |
|  | 12/01/2024     | \$57.65   | \$14.75 | \$16.15 | \$0.00                    | \$88.55    |
|  | 06/01/2025     | \$58.93   | \$14.75 | \$16.15 | \$0.00                    | \$89.83    |
|  | 12/01/2025     | \$60.37   | \$14.75 | \$16.15 | \$0.00                    | \$91.27    |
|  | 06/01/2026     | \$61.65   | \$14.75 | \$16.15 | \$0.00                    | \$92.55    |
|  | 12/01/2026     | \$63.09   | \$14.75 | \$16.15 | \$0.00                    | \$93.99    |
| For apprentice rates see "Apprentice- OPERATING ENGINEERS"                     |                |           |         |         |                           |            |
| ROOFER (Inc.Roofer Waterproofing &Roofer Damproofg)<br><i>ROOFERS LOCAL 33</i> | 08/01/2023     | \$50.03   | \$12.78 | \$20.20 | \$0.00                    | \$83.01    |
|  | 02/01/2024     | \$51.28   | \$12.78 | \$20.20 | \$0.00                    | \$84.26    |
|  | 08/01/2024     | \$52.78   | \$12.78 | \$20.20 | \$0.00                    | \$85.76    |
|  | 02/01/2025     | \$54.03   | \$12.78 | \$20.20 | \$0.00                    | \$87.01    |
|  | 08/01/2025     | \$55.53   | \$12.78 | \$20.20 | \$0.00                    | \$88.51    |
|  | 02/01/2026     | \$56.78   | \$12.78 | \$20.20 | \$0.00                    | \$89.76    |

**Classification**

**Effective Date    Base Wage    Health    Pension    Supplemental Unemployment    Total Rate**

**Apprentice - ROOFER - Local 33**

**Effective Date - 08/01/2023**

| Step | percent | Apprentice Base Wage | Health  | Pension | Supplemental Unemployment | Total Rate |
|------|---------|----------------------|---------|---------|---------------------------|------------|
| 1    | 50      | \$25.02              | \$12.78 | \$5.59  | \$0.00                    | \$43.39    |
| 2    | 60      | \$30.02              | \$12.78 | \$20.20 | \$0.00                    | \$63.00    |
| 3    | 65      | \$32.52              | \$12.78 | \$20.20 | \$0.00                    | \$65.50    |
| 4    | 75      | \$37.52              | \$12.78 | \$20.20 | \$0.00                    | \$70.50    |
| 5    | 85      | \$42.53              | \$12.78 | \$20.20 | \$0.00                    | \$75.51    |

**Effective Date - 02/01/2024**

| Step | percent | Apprentice Base Wage | Health  | Pension | Supplemental Unemployment | Total Rate |
|------|---------|----------------------|---------|---------|---------------------------|------------|
| 1    | 50      | \$25.64              | \$12.78 | \$5.59  | \$0.00                    | \$44.01    |
| 2    | 60      | \$30.77              | \$12.78 | \$20.20 | \$0.00                    | \$63.75    |
| 3    | 65      | \$33.33              | \$12.78 | \$20.20 | \$0.00                    | \$66.31    |
| 4    | 75      | \$38.46              | \$12.78 | \$20.20 | \$0.00                    | \$71.44    |
| 5    | 85      | \$43.59              | \$12.78 | \$20.20 | \$0.00                    | \$76.57    |

**Notes: \*\* 1:5, 2:6-10, the 1:10; Reroofing: 1:4, then 1:1**  
 Step 1 is 2000 hrs.; Steps 2-5 are 1000 hrs.  
 (Hot Pitch Mechanics' receive \$1.00 hr. above ROOFER)

**Apprentice to Journeyworker Ratio:\*\***

|  |            |         |         |         |        |         |
|--|------------|---------|---------|---------|--------|---------|
| ROOFER SLATE / TILE / PRECAST CONCRETE<br>ROOFERS LOCAL 33 | 08/01/2023 | \$50.28 | \$12.78 | \$20.20 | \$0.00 | \$83.26 |
|  | 02/01/2024 | \$51.53 | \$12.78 | \$20.20 | \$0.00 | \$84.51 |
|  | 08/01/2024 | \$53.03 | \$12.78 | \$20.20 | \$0.00 | \$86.01 |
|  | 02/01/2025 | \$54.28 | \$12.78 | \$20.20 | \$0.00 | \$87.26 |
|  | 08/01/2025 | \$55.78 | \$12.78 | \$20.20 | \$0.00 | \$88.76 |
|  | 02/01/2026 | \$57.03 | \$12.78 | \$20.20 | \$0.00 | \$90.01 |
| For apprentice rates see "Apprentice- ROOFER"              |            |         |         |         |        |         |
| SHEETMETAL WORKER<br>SHEETMETAL WORKERS LOCAL 63           | 07/01/2023 | \$42.55 | \$10.64 | \$17.54 | \$2.05 | \$72.78 |
|  | 01/01/2024 | \$43.80 | \$10.64 | \$17.54 | \$2.05 | \$74.03 |
|  | 07/01/2024 | \$45.05 | \$10.64 | \$17.54 | \$2.05 | \$75.28 |
|  | 01/01/2025 | \$46.30 | \$10.64 | \$17.54 | \$2.05 | \$76.53 |

**Classification**

**Effective Date    Base Wage    Health    Pension    Supplemental Unemployment    Total Rate**

**Apprentice - SHEET METAL WORKER - Local 63**

**Effective Date - 07/01/2023**

| Step | percent | Apprentice Base Wage | Health | Pension | Supplemental Unemployment | Total Rate |
|------|---------|----------------------|--------|---------|---------------------------|------------|
| 1    | 45      | \$19.15              | \$4.79 | \$4.76  | \$0.92                    | \$29.62    |
| 2    | 50      | \$21.28              | \$5.32 | \$5.29  | \$1.03                    | \$32.92    |
| 3    | 55      | \$23.40              | \$5.85 | \$5.82  | \$1.13                    | \$36.20    |
| 4    | 60      | \$25.53              | \$6.38 | \$6.35  | \$1.23                    | \$39.49    |
| 5    | 65      | \$27.66              | \$6.92 | \$6.88  | \$1.33                    | \$42.79    |
| 6    | 70      | \$29.79              | \$7.45 | \$7.41  | \$1.44                    | \$46.09    |
| 7    | 75      | \$31.91              | \$7.98 | \$7.94  | \$1.54                    | \$49.37    |
| 8    | 80      | \$34.04              | \$8.51 | \$15.42 | \$1.64                    | \$59.61    |
| 9    | 85      | \$36.17              | \$9.04 | \$15.95 | \$1.74                    | \$62.90    |
| 10   | 90      | \$38.30              | \$9.58 | \$16.48 | \$1.85                    | \$66.21    |

**Effective Date - 01/01/2024**

| Step | percent | Apprentice Base Wage | Health | Pension | Supplemental Unemployment | Total Rate |
|------|---------|----------------------|--------|---------|---------------------------|------------|
| 1    | 45      | \$19.71              | \$4.79 | \$4.76  | \$0.92                    | \$30.18    |
| 2    | 50      | \$21.90              | \$5.32 | \$5.29  | \$1.03                    | \$33.54    |
| 3    | 55      | \$24.09              | \$5.85 | \$5.82  | \$1.13                    | \$36.89    |
| 4    | 60      | \$26.28              | \$6.38 | \$6.35  | \$1.23                    | \$40.24    |
| 5    | 65      | \$28.47              | \$6.92 | \$6.88  | \$1.33                    | \$43.60    |
| 6    | 70      | \$30.66              | \$7.45 | \$7.41  | \$1.44                    | \$46.96    |
| 7    | 75      | \$32.85              | \$7.98 | \$7.94  | \$1.54                    | \$50.31    |
| 8    | 80      | \$35.04              | \$8.51 | \$15.42 | \$1.64                    | \$60.61    |
| 9    | 85      | \$37.23              | \$9.04 | \$15.95 | \$1.74                    | \$63.96    |
| 10   | 90      | \$39.42              | \$9.58 | \$13.92 | \$1.85                    | \$64.77    |

**Notes:**

**Apprentice to Journeyworker Ratio:1:3**

|   |            |         |         |         |        |         |
|---|------------|---------|---------|---------|--------|---------|
| SPECIALIZED EARTH MOVING EQUIP < 35 TONS<br>TEAMSTERS JOINT COUNCIL NO. 10 ZONE B | 06/01/2023 | \$39.24 | \$14.57 | \$17.29 | \$0.00 | \$71.10 |
|   | 12/01/2023 | \$39.24 | \$14.57 | \$18.67 | \$0.00 | \$72.48 |
|   | 01/01/2024 | \$39.24 | \$15.07 | \$18.67 | \$0.00 | \$72.98 |
|   | 06/01/2024 | \$40.24 | \$15.07 | \$18.67 | \$0.00 | \$73.98 |
|   | 12/01/2024 | \$40.24 | \$15.07 | \$20.17 | \$0.00 | \$75.48 |
|   | 01/01/2025 | \$40.24 | \$15.57 | \$20.17 | \$0.00 | \$75.98 |
|   | 06/01/2025 | \$41.24 | \$15.57 | \$20.17 | \$0.00 | \$76.98 |
|   | 12/01/2025 | \$41.24 | \$15.57 | \$21.78 | \$0.00 | \$78.59 |
|   | 01/01/2026 | \$41.24 | \$16.17 | \$21.78 | \$0.00 | \$79.19 |
|   | 06/01/2026 | \$42.24 | \$16.17 | \$21.78 | \$0.00 | \$80.19 |
|   | 12/01/2026 | \$42.24 | \$16.17 | \$23.52 | \$0.00 | \$81.93 |
|   | 01/01/2027 | \$42.24 | \$16.77 | \$23.52 | \$0.00 | \$82.53 |

| Classification   | Effective Date | Base Wage | Health  | Pension | Supplemental Unemployment | Total Rate |
|--|----------------|-----------|---------|---------|---------------------------|------------|
| SPECIALIZED EARTH MOVING EQUIP > 35 TONS<br><i>TEAMSTERS JOINT COUNCIL NO. 10 ZONE B</i> | 06/01/2023     | \$39.53   | \$14.57 | \$17.29 | \$0.00                    | \$71.39    |
|  | 12/01/2023     | \$39.53   | \$14.57 | \$18.67 | \$0.00                    | \$72.77    |
|  | 01/01/2024     | \$39.53   | \$15.07 | \$18.67 | \$0.00                    | \$73.27    |
|  | 06/01/2024     | \$40.53   | \$15.07 | \$18.67 | \$0.00                    | \$74.27    |
|  | 12/01/2024     | \$40.53   | \$15.07 | \$20.17 | \$0.00                    | \$75.77    |
|  | 01/01/2025     | \$40.53   | \$15.57 | \$20.17 | \$0.00                    | \$76.27    |
|  | 06/01/2025     | \$41.53   | \$15.57 | \$20.17 | \$0.00                    | \$77.27    |
|  | 12/01/2025     | \$41.53   | \$15.57 | \$21.78 | \$0.00                    | \$78.88    |
|  | 01/01/2026     | \$41.53   | \$16.17 | \$21.78 | \$0.00                    | \$79.48    |
|  | 06/01/2026     | \$42.53   | \$16.17 | \$21.78 | \$0.00                    | \$80.48    |
|  | 12/01/2026     | \$42.53   | \$16.17 | \$23.52 | \$0.00                    | \$82.22    |
| 01/01/2027   | \$42.53        | \$16.77   | \$23.52 | \$0.00  | \$82.82                   |            |
| SPRINKLER FITTER<br><i>SPRINKLER FITTERS LOCAL 669</i>                                   | 04/01/2023     | \$47.43   | \$11.45 | \$16.61 | \$0.00                    | \$75.49    |

**Apprentice - SPRINKLER FITTER - Local 669**

**Effective Date - 04/01/2023**

| Step | percent | Apprentice Base Wage | Health  | Pension | Supplemental Unemployment | Total Rate |
|------|---------|----------------------|---------|---------|---------------------------|------------|
| 1    | 45      | \$21.34              | \$8.22  | \$0.00  | \$0.00                    | \$29.56    |
| 2    | 50      | \$23.72              | \$8.22  | \$0.00  | \$0.00                    | \$31.94    |
| 3    | 55      | \$26.09              | \$11.45 | \$7.20  | \$0.00                    | \$44.74    |
| 4    | 60      | \$28.46              | \$11.45 | \$8.35  | \$0.00                    | \$48.26    |
| 5    | 65      | \$30.83              | \$11.45 | \$8.35  | \$0.00                    | \$50.63    |
| 6    | 70      | \$33.20              | \$11.45 | \$8.60  | \$0.00                    | \$53.25    |
| 7    | 75      | \$35.57              | \$11.45 | \$8.60  | \$0.00                    | \$55.62    |
| 8    | 80      | \$37.94              | \$11.45 | \$8.60  | \$0.00                    | \$57.99    |
| 9    | 85      | \$40.32              | \$11.45 | \$8.60  | \$0.00                    | \$60.37    |
| 10   | 90      | \$42.69              | \$11.45 | \$8.60  | \$0.00                    | \$62.74    |

**Notes:**

**Apprentice to Journeyworker Ratio:1:1**

|   |            |         |         |         |        |         |
|---|------------|---------|---------|---------|--------|---------|
| STEAM BOILER OPERATOR<br><i>OPERATING ENGINEERS LOCAL 4</i> | 06/01/2023 | \$53.69 | \$14.75 | \$16.15 | \$0.00 | \$84.59 |
|   | 12/01/2023 | \$54.93 | \$14.75 | \$16.15 | \$0.00 | \$85.83 |
|   | 06/01/2024 | \$56.21 | \$14.75 | \$16.15 | \$0.00 | \$87.11 |
|   | 12/01/2024 | \$57.65 | \$14.75 | \$16.15 | \$0.00 | \$88.55 |
|   | 06/01/2025 | \$58.93 | \$14.75 | \$16.15 | \$0.00 | \$89.83 |
|   | 12/01/2025 | \$60.37 | \$14.75 | \$16.15 | \$0.00 | \$91.27 |
|   | 06/01/2026 | \$61.65 | \$14.75 | \$16.15 | \$0.00 | \$92.55 |
|   | 12/01/2026 | \$63.09 | \$14.75 | \$16.15 | \$0.00 | \$93.99 |

For apprentice rates see "Apprentice- OPERATING ENGINEERS"

| Classification   | Effective Date | Base Wage | Health  | Pension | Supplemental Unemployment | Total Rate |
|--|----------------|-----------|---------|---------|---------------------------|------------|
| TAMPERS, SELF-PROPELLED OR TRACTOR DRAWN<br><i>OPERATING ENGINEERS LOCAL 4</i> | 06/01/2023     | \$53.69   | \$14.75 | \$16.15 | \$0.00                    | \$84.59    |
|  | 12/01/2023     | \$54.93   | \$14.75 | \$16.15 | \$0.00                    | \$85.83    |
|  | 06/01/2024     | \$56.21   | \$14.75 | \$16.15 | \$0.00                    | \$87.11    |
|  | 12/01/2024     | \$57.65   | \$14.75 | \$16.15 | \$0.00                    | \$88.55    |
|  | 06/01/2025     | \$58.93   | \$14.75 | \$16.15 | \$0.00                    | \$89.83    |
|  | 12/01/2025     | \$60.37   | \$14.75 | \$16.15 | \$0.00                    | \$91.27    |
|  | 06/01/2026     | \$61.65   | \$14.75 | \$16.15 | \$0.00                    | \$92.55    |
|  | 12/01/2026     | \$63.09   | \$14.75 | \$16.15 | \$0.00                    | \$93.99    |

For apprentice rates see "Apprentice- OPERATING ENGINEERS"

|  |            |         |         |         |        |          |
|--|------------|---------|---------|---------|--------|----------|
| TERRAZZO FINISHERS<br><i>BRICKLAYERS LOCAL 3 - MARBLE &amp; TILE</i> | 08/01/2023 | \$61.34 | \$11.49 | \$22.34 | \$0.00 | \$95.17  |
|  | 02/01/2024 | \$62.59 | \$11.49 | \$22.34 | \$0.00 | \$96.42  |
|  | 08/01/2024 | \$64.69 | \$11.49 | \$22.34 | \$0.00 | \$98.52  |
|  | 02/01/2025 | \$65.99 | \$11.49 | \$22.34 | \$0.00 | \$99.82  |
|  | 08/01/2025 | \$68.14 | \$11.49 | \$22.34 | \$0.00 | \$101.97 |
|  | 02/01/2026 | \$69.49 | \$11.49 | \$22.34 | \$0.00 | \$103.32 |
|  | 08/01/2026 | \$71.69 | \$11.49 | \$22.34 | \$0.00 | \$105.52 |
|  | 02/01/2027 | \$73.09 | \$11.49 | \$22.34 | \$0.00 | \$106.92 |

**Apprentice - TERRAZZO FINISHER - Local 3 Marble & Tile**

**Effective Date - 08/01/2023**

| Step | percent | Apprentice Base Wage | Health  | Pension | Supplemental Unemployment | Total Rate |
|------|---------|----------------------|---------|---------|---------------------------|------------|
| 1    | 50      | \$30.67              | \$11.49 | \$22.34 | \$0.00                    | \$64.50    |
| 2    | 60      | \$36.80              | \$11.49 | \$22.34 | \$0.00                    | \$70.63    |
| 3    | 70      | \$42.94              | \$11.49 | \$22.34 | \$0.00                    | \$76.77    |
| 4    | 80      | \$49.07              | \$11.49 | \$22.34 | \$0.00                    | \$82.90    |
| 5    | 90      | \$55.21              | \$11.49 | \$22.34 | \$0.00                    | \$89.04    |

**Effective Date - 02/01/2024**

| Step | percent | Apprentice Base Wage | Health  | Pension | Supplemental Unemployment | Total Rate |
|------|---------|----------------------|---------|---------|---------------------------|------------|
| 1    | 50      | \$31.30              | \$11.49 | \$22.34 | \$0.00                    | \$65.13    |
| 2    | 60      | \$37.55              | \$11.49 | \$22.34 | \$0.00                    | \$71.38    |
| 3    | 70      | \$43.81              | \$11.49 | \$22.34 | \$0.00                    | \$77.64    |
| 4    | 80      | \$50.07              | \$11.49 | \$22.34 | \$0.00                    | \$83.90    |
| 5    | 90      | \$56.33              | \$11.49 | \$22.34 | \$0.00                    | \$90.16    |

**Notes:**

**Apprentice to Journeyworker Ratio:1:3**

| Classification   | Effective Date | Base Wage | Health  | Pension | Supplemental Unemployment | Total Rate |
|--|----------------|-----------|---------|---------|---------------------------|------------|
| TEST BORING DRILLER<br><i>LABORERS - FOUNDATION AND MARINE</i>           | 06/01/2023     | \$47.58   | \$9.40  | \$17.97 | \$0.00                    | \$74.95    |
|  | 12/01/2023     | \$48.83   | \$9.40  | \$17.97 | \$0.00                    | \$76.20    |
|  | 06/01/2024     | \$50.31   | \$9.40  | \$17.97 | \$0.00                    | \$77.68    |
|  | 12/01/2024     | \$51.78   | \$9.40  | \$17.97 | \$0.00                    | \$79.15    |
|  | 06/01/2025     | \$53.28   | \$9.40  | \$17.97 | \$0.00                    | \$80.65    |
|  | 12/01/2025     | \$54.78   | \$9.40  | \$17.97 | \$0.00                    | \$82.15    |
|  | 06/01/2026     | \$56.33   | \$9.40  | \$17.97 | \$0.00                    | \$83.70    |
|  | 12/01/2026     | \$57.83   | \$9.40  | \$17.97 | \$0.00                    | \$85.20    |
| For apprentice rates see "Apprentice- LABORER"                           |                |           |         |         |                           |            |
| TEST BORING DRILLER HELPER<br><i>LABORERS - FOUNDATION AND MARINE</i>    | 06/01/2023     | \$43.70   | \$9.40  | \$17.97 | \$0.00                    | \$71.07    |
|  | 12/01/2023     | \$44.95   | \$9.40  | \$17.97 | \$0.00                    | \$72.32    |
|  | 06/01/2024     | \$46.43   | \$9.40  | \$17.97 | \$0.00                    | \$73.80    |
|  | 12/01/2024     | \$47.90   | \$9.40  | \$17.97 | \$0.00                    | \$75.27    |
|  | 06/01/2025     | \$49.40   | \$9.40  | \$17.97 | \$0.00                    | \$76.77    |
|  | 12/01/2025     | \$50.90   | \$9.40  | \$17.97 | \$0.00                    | \$78.27    |
|  | 06/01/2026     | \$52.45   | \$9.40  | \$17.97 | \$0.00                    | \$79.82    |
|  | 12/01/2026     | \$53.95   | \$9.40  | \$17.97 | \$0.00                    | \$81.32    |
| For apprentice rates see "Apprentice- LABORER"                           |                |           |         |         |                           |            |
| TEST BORING LABORER<br><i>LABORERS - FOUNDATION AND MARINE</i>           | 06/01/2023     | \$43.58   | \$9.40  | \$17.97 | \$0.00                    | \$70.95    |
|  | 12/01/2023     | \$44.83   | \$9.40  | \$17.97 | \$0.00                    | \$72.20    |
|  | 06/01/2024     | \$46.31   | \$9.40  | \$17.97 | \$0.00                    | \$73.68    |
|  | 12/01/2024     | \$47.78   | \$9.40  | \$17.97 | \$0.00                    | \$75.15    |
|  | 06/01/2025     | \$49.28   | \$9.40  | \$17.97 | \$0.00                    | \$76.65    |
|  | 12/01/2025     | \$50.78   | \$9.40  | \$17.97 | \$0.00                    | \$78.15    |
|  | 06/01/2026     | \$52.33   | \$9.40  | \$17.97 | \$0.00                    | \$79.70    |
|  | 12/01/2026     | \$53.83   | \$9.40  | \$17.97 | \$0.00                    | \$81.20    |
| For apprentice rates see "Apprentice- LABORER"                           |                |           |         |         |                           |            |
| TRACTORS/PORTABLE STEAM GENERATORS<br><i>OPERATING ENGINEERS LOCAL 4</i> | 06/01/2023     | \$53.69   | \$14.75 | \$16.15 | \$0.00                    | \$84.59    |
|  | 12/01/2023     | \$54.93   | \$14.75 | \$16.15 | \$0.00                    | \$85.83    |
|  | 06/01/2024     | \$56.21   | \$14.75 | \$16.15 | \$0.00                    | \$87.11    |
|  | 12/01/2024     | \$57.65   | \$14.75 | \$16.15 | \$0.00                    | \$88.55    |
|  | 06/01/2025     | \$58.93   | \$14.75 | \$16.15 | \$0.00                    | \$89.83    |
|  | 12/01/2025     | \$60.37   | \$14.75 | \$16.15 | \$0.00                    | \$91.27    |
|  | 06/01/2026     | \$61.65   | \$14.75 | \$16.15 | \$0.00                    | \$92.55    |
|  | 12/01/2026     | \$63.09   | \$14.75 | \$16.15 | \$0.00                    | \$93.99    |
| For apprentice rates see "Apprentice- OPERATING ENGINEERS"               |                |           |         |         |                           |            |

| Classification  | Effective Date | Base Wage | Health  | Pension | Supplemental Unemployment | Total Rate |
|---|----------------|-----------|---------|---------|---------------------------|------------|
| TRAILERS FOR EARTH MOVING EQUIPMENT<br><i>TEAMSTERS JOINT COUNCIL NO. 10 ZONE B</i> | 06/01/2023     | \$39.82   | \$14.57 | \$17.29 | \$0.00                    | \$71.68    |
|   | 12/01/2023     | \$39.82   | \$14.57 | \$18.67 | \$0.00                    | \$73.06    |
|   | 01/01/2024     | \$39.82   | \$15.07 | \$18.67 | \$0.00                    | \$73.56    |
|   | 06/01/2024     | \$40.82   | \$15.07 | \$18.67 | \$0.00                    | \$74.56    |
|   | 12/01/2024     | \$40.82   | \$15.07 | \$20.17 | \$0.00                    | \$76.06    |
|   | 01/01/2025     | \$40.82   | \$15.57 | \$20.17 | \$0.00                    | \$76.56    |
|   | 06/01/2025     | \$41.82   | \$15.57 | \$20.17 | \$0.00                    | \$77.56    |
|   | 12/01/2025     | \$41.82   | \$15.57 | \$21.78 | \$0.00                    | \$79.17    |
|   | 01/01/2026     | \$41.82   | \$16.17 | \$21.78 | \$0.00                    | \$79.77    |
|   | 06/01/2026     | \$42.82   | \$16.17 | \$21.78 | \$0.00                    | \$80.77    |
|   | 12/01/2026     | \$42.82   | \$16.17 | \$23.52 | \$0.00                    | \$82.51    |
|   | 01/01/2027     | \$42.82   | \$16.77 | \$23.52 | \$0.00                    | \$83.11    |
| TUNNEL WORK - COMPRESSED AIR<br><i>LABORERS (COMPRESSED AIR)</i>                    | 06/01/2023     | \$55.81   | \$9.40  | \$18.42 | \$0.00                    | \$83.63    |
|   | 12/01/2023     | \$57.06   | \$9.40  | \$18.42 | \$0.00                    | \$84.88    |
|   | 06/01/2024     | \$58.54   | \$9.40  | \$18.42 | \$0.00                    | \$86.36    |
|   | 12/01/2024     | \$60.01   | \$9.40  | \$18.42 | \$0.00                    | \$87.83    |
|   | 06/01/2025     | \$61.51   | \$9.40  | \$18.42 | \$0.00                    | \$89.33    |
|   | 12/01/2025     | \$63.01   | \$9.40  | \$18.42 | \$0.00                    | \$90.83    |
|   | 06/01/2026     | \$64.56   | \$9.40  | \$18.42 | \$0.00                    | \$92.38    |
|   | 12/01/2026     | \$66.06   | \$9.40  | \$18.42 | \$0.00                    | \$93.88    |
| For apprentice rates see "Apprentice- LABORER"                                      |                |           |         |         |                           |            |
| TUNNEL WORK - COMPRESSED AIR (HAZ. WASTE)<br><i>LABORERS (COMPRESSED AIR)</i>       | 06/01/2023     | \$57.81   | \$9.40  | \$18.42 | \$0.00                    | \$85.63    |
|   | 12/01/2023     | \$59.06   | \$9.40  | \$18.42 | \$0.00                    | \$86.88    |
|   | 06/01/2024     | \$60.54   | \$9.40  | \$18.42 | \$0.00                    | \$88.36    |
|   | 12/01/2024     | \$62.01   | \$9.40  | \$18.42 | \$0.00                    | \$89.83    |
|   | 06/01/2025     | \$63.51   | \$9.40  | \$18.42 | \$0.00                    | \$91.33    |
|   | 12/01/2025     | \$65.01   | \$9.40  | \$18.42 | \$0.00                    | \$92.83    |
|   | 06/01/2026     | \$66.56   | \$9.40  | \$18.42 | \$0.00                    | \$94.38    |
|   | 12/01/2026     | \$68.06   | \$9.40  | \$18.42 | \$0.00                    | \$95.88    |
| For apprentice rates see "Apprentice- LABORER"                                      |                |           |         |         |                           |            |
| TUNNEL WORK - FREE AIR<br><i>LABORERS (FREE AIR TUNNEL)</i>                         | 06/01/2023     | \$47.88   | \$9.40  | \$18.42 | \$0.00                    | \$75.70    |
|   | 12/01/2023     | \$49.13   | \$9.40  | \$18.42 | \$0.00                    | \$76.95    |
|   | 06/01/2024     | \$50.61   | \$9.40  | \$18.42 | \$0.00                    | \$78.43    |
|   | 12/01/2024     | \$52.08   | \$9.40  | \$18.42 | \$0.00                    | \$79.90    |
|   | 06/01/2025     | \$53.58   | \$9.40  | \$18.42 | \$0.00                    | \$81.40    |
|   | 12/01/2025     | \$55.08   | \$9.40  | \$18.42 | \$0.00                    | \$82.90    |
|   | 06/01/2026     | \$56.63   | \$9.40  | \$18.42 | \$0.00                    | \$84.45    |
|   | 12/01/2026     | \$58.13   | \$9.40  | \$18.42 | \$0.00                    | \$85.95    |
| For apprentice rates see "Apprentice- LABORER"                                      |                |           |         |         |                           |            |

| Classification   | Effective Date | Base Wage | Health  | Pension | Supplemental Unemployment | Total Rate |
|--|----------------|-----------|---------|---------|---------------------------|------------|
| TUNNEL WORK - FREE AIR (HAZ. WASTE)<br><i>LABORERS (FREE AIR TUNNEL)</i> | 06/01/2023     | \$49.88   | \$9.40  | \$18.42 | \$0.00                    | \$77.70    |
|  | 12/01/2023     | \$51.13   | \$9.40  | \$18.42 | \$0.00                    | \$78.95    |
|  | 06/01/2024     | \$52.61   | \$9.40  | \$18.42 | \$0.00                    | \$80.43    |
|  | 12/01/2024     | \$54.08   | \$9.40  | \$18.42 | \$0.00                    | \$81.90    |
|  | 06/01/2025     | \$55.58   | \$9.40  | \$18.42 | \$0.00                    | \$83.40    |
|  | 12/01/2025     | \$57.08   | \$9.40  | \$18.42 | \$0.00                    | \$84.90    |
|  | 06/01/2026     | \$58.63   | \$9.40  | \$18.42 | \$0.00                    | \$86.45    |
|  | 12/01/2026     | \$60.13   | \$9.40  | \$18.42 | \$0.00                    | \$87.95    |
| For apprentice rates see "Apprentice- LABORER"                           |                |           |         |         |                           |            |
| VAC-HAUL<br><i>TEAMSTERS JOINT COUNCIL NO. 10 ZONE B</i>                 | 06/01/2023     | \$39.24   | \$14.57 | \$17.29 | \$0.00                    | \$71.10    |
|  | 12/01/2023     | \$39.24   | \$14.57 | \$18.67 | \$0.00                    | \$72.48    |
|  | 01/01/2024     | \$39.24   | \$15.07 | \$18.67 | \$0.00                    | \$72.98    |
|  | 06/01/2024     | \$40.24   | \$15.07 | \$18.67 | \$0.00                    | \$73.98    |
|  | 12/01/2024     | \$40.24   | \$15.07 | \$20.17 | \$0.00                    | \$75.48    |
|  | 01/01/2025     | \$40.24   | \$15.57 | \$20.17 | \$0.00                    | \$75.98    |
|  | 06/01/2025     | \$41.24   | \$15.57 | \$20.17 | \$0.00                    | \$76.98    |
|  | 12/01/2025     | \$41.24   | \$15.57 | \$21.78 | \$0.00                    | \$78.59    |
|  | 01/01/2026     | \$41.24   | \$16.17 | \$21.78 | \$0.00                    | \$79.19    |
|  | 06/01/2026     | \$42.24   | \$16.17 | \$21.78 | \$0.00                    | \$80.19    |
|  | 12/01/2026     | \$42.24   | \$16.17 | \$23.52 | \$0.00                    | \$81.93    |
|  | 01/01/2027     | \$42.24   | \$16.77 | \$23.52 | \$0.00                    | \$82.53    |
| VOICE-DATA-VIDEO TECHNICIAN<br><i>ELECTRICIANS LOCAL 96</i>              | 09/04/2022     | \$34.19   | \$12.20 | \$15.91 | \$0.00                    | \$62.30    |

**Apprentice - VOICE-DATA-VIDEO TECHNICIAN - Local 96**

**Effective Date - 09/04/2022**

| Step | percent | Apprentice Base Wage | Health  | Pension | Supplemental Unemployment | Total Rate |
|------|---------|----------------------|---------|---------|---------------------------|------------|
| 1    | 50      | \$17.10              | \$12.20 | \$4.27  | \$0.00                    | \$33.57    |
| 2    | 55      | \$18.80              | \$12.20 | \$4.32  | \$0.00                    | \$35.32    |
| 3    | 60      | \$20.51              | \$12.20 | \$15.50 | \$0.00                    | \$48.21    |
| 4    | 65      | \$22.22              | \$12.20 | \$15.55 | \$0.00                    | \$49.97    |
| 5    | 70      | \$23.93              | \$12.20 | \$15.60 | \$0.00                    | \$51.73    |
| 6    | 75      | \$25.64              | \$12.20 | \$15.65 | \$0.00                    | \$53.49    |
| 7    | 80      | \$27.35              | \$12.20 | \$15.70 | \$0.00                    | \$55.25    |
| 8    | 85      | \$29.06              | \$12.20 | \$15.75 | \$0.00                    | \$57.01    |

Notes:

**Apprentice to Journeyworker Ratio:1:1**

|  |            |         |        |         |        |         |
|--|------------|---------|--------|---------|--------|---------|
| WAGON DRILL OPERATOR<br><i>LABORERS - ZONE 2</i> | 06/01/2023 | \$37.71 | \$9.40 | \$16.89 | \$0.00 | \$64.00 |
|  | 12/01/2023 | \$38.61 | \$9.40 | \$16.89 | \$0.00 | \$64.90 |

For apprentice rates see "Apprentice- LABORER"



| Classification  | Effective Date                                 | Base Wage | Health  | Pension | Supplemental Unemployment | Total Rate |
|---|--|-----------|---------|---------|---------------------------|------------|
| WAGON DRILL OPERATOR (HEAVY & HIGHWAY)<br><i>LABORERS - ZONE 2 (HEAVY &amp; HIGHWAY)</i>            | 06/01/2023                                     | \$37.71   | \$9.40  | \$16.89 | \$0.00                    | \$64.00    |
|   | 12/01/2023                                     | \$38.61   | \$9.40  | \$16.89 | \$0.00                    | \$64.90    |
|   | 06/01/2024                                     | \$39.94   | \$9.40  | \$16.89 | \$0.00                    | \$66.23    |
|   | 12/01/2024                                     | \$41.27   | \$9.40  | \$16.89 | \$0.00                    | \$67.56    |
|   | 06/01/2025                                     | \$42.66   | \$9.40  | \$16.89 | \$0.00                    | \$68.95    |
|   | 12/01/2025                                     | \$44.04   | \$9.40  | \$16.89 | \$0.00                    | \$70.33    |
|   | 06/01/2026                                     | \$45.48   | \$9.40  | \$16.89 | \$0.00                    | \$71.77    |
|   | 12/01/2026                                     | \$46.92   | \$9.40  | \$16.89 | \$0.00                    | \$73.21    |
| For apprentice rates see "Apprentice- LABORER (Heavy and Highway)                                   |  |           |         |         |                           |            |
| WASTE WATER PUMP OPERATOR<br><i>OPERATING ENGINEERS LOCAL 4</i>                                     | 06/01/2023                                     | \$54.28   | \$14.75 | \$16.15 | \$0.00                    | \$85.18    |
|   | 12/01/2023                                     | \$55.53   | \$14.75 | \$16.15 | \$0.00                    | \$86.43    |
|   | 06/01/2024                                     | \$56.83   | \$14.75 | \$16.15 | \$0.00                    | \$87.73    |
|   | 12/01/2024                                     | \$58.28   | \$14.75 | \$16.15 | \$0.00                    | \$89.18    |
|   | 06/01/2025                                     | \$59.58   | \$14.75 | \$16.15 | \$0.00                    | \$90.48    |
|   | 12/01/2025                                     | \$61.03   | \$14.75 | \$16.15 | \$0.00                    | \$91.93    |
|   | 06/01/2026                                     | \$62.33   | \$14.75 | \$16.15 | \$0.00                    | \$93.23    |
|   | 12/01/2026                                     | \$63.78   | \$14.75 | \$16.15 | \$0.00                    | \$94.68    |
| For apprentice rates see "Apprentice- OPERATING ENGINEERS"  |  |           |         |         |                           |            |
| WATER METER INSTALLER<br><i>PLUMBERS LOCAL 4</i>  | 09/01/2023                                     | \$52.55   | \$9.90  | \$17.42 | \$0.00                    | \$79.87    |
|   | 03/01/2024                                     | \$53.95   | \$9.90  | \$17.42 | \$0.00                    | \$81.27    |
|   | 09/01/2024                                     | \$55.35   | \$9.90  | \$17.42 | \$0.00                    | \$82.67    |
|   | 03/01/2025                                     | \$56.75   | \$9.90  | \$17.42 | \$0.00                    | \$84.07    |
|   | 09/01/2025                                     | \$58.15   | \$9.90  | \$17.42 | \$0.00                    | \$85.47    |
|   | 03/01/2026                                     | \$59.55   | \$9.90  | \$17.42 | \$0.00                    | \$86.87    |
| For apprentice rates see "Apprentice- PLUMBER/PIPEFITTER" or "PLUMBER/GASFITTER"                    |  |           |         |         |                           |            |
| <b>Outside Electrical - East</b>  |  |           |         |         |                           |            |
| CABLE TECHNICIAN (Power Zone)<br><i>OUTSIDE ELECTRICAL WORKERS - EAST LOCAL 104</i>                 | 08/30/2020                                     | \$29.67   | \$9.25  | \$1.89  | \$0.00                    | \$40.81    |
|   | For apprentice rates see "Apprentice- LINEMAN" |           |         |         |                           |            |
| CABLEMAN (Underground Ducts & Cables)<br><i>OUTSIDE ELECTRICAL WORKERS - EAST LOCAL 104</i>         | 08/30/2020                                     | \$42.03   | \$9.25  | \$10.27 | \$0.00                    | \$61.55    |
|   | For apprentice rates see "Apprentice- LINEMAN" |           |         |         |                           |            |
| DRIVER / GROUNDMAN CDL<br><i>OUTSIDE ELECTRICAL WORKERS - EAST LOCAL 104</i>                        | 08/30/2020                                     | \$34.62   | \$9.25  | \$10.07 | \$0.00                    | \$53.94    |
|   | For apprentice rates see "Apprentice- LINEMAN" |           |         |         |                           |            |
| DRIVER / GROUNDMAN -Inexperienced (<2000 Hrs)<br><i>OUTSIDE ELECTRICAL WORKERS - EAST LOCAL 104</i> | 08/30/2020                                     | \$27.20   | \$9.25  | \$1.82  | \$0.00                    | \$38.27    |
|   | For apprentice rates see "Apprentice- LINEMAN" |           |         |         |                           |            |
| EQUIPMENT OPERATOR (Class A CDL)<br><i>OUTSIDE ELECTRICAL WORKERS - EAST LOCAL 104</i>              | 08/30/2020                                     | \$42.03   | \$9.25  | \$14.35 | \$0.00                    | \$65.63    |
|   | For apprentice rates see "Apprentice- LINEMAN" |           |         |         |                           |            |
| EQUIPMENT OPERATOR (Class B CDL)<br><i>OUTSIDE ELECTRICAL WORKERS - EAST LOCAL 104</i>              | 08/30/2020                                     | \$37.09   | \$9.25  | \$10.87 | \$0.00                    | \$57.21    |
|   | For apprentice rates see "Apprentice- LINEMAN" |           |         |         |                           |            |
| GROUNDMAN<br><i>OUTSIDE ELECTRICAL WORKERS - EAST LOCAL 104</i>                                     | 08/30/2020                                     | \$27.20   | \$9.25  | \$1.82  | \$0.00                    | \$38.27    |
|   | For apprentice rates see "Apprentice- LINEMAN" |           |         |         |                           |            |
| GROUNDMAN -Inexperienced (<2000 Hrs.)<br><i>OUTSIDE ELECTRICAL WORKERS - EAST LOCAL 104</i>         | 08/30/2020                                     | \$22.25   | \$9.25  | \$1.82  | \$0.00                    | \$33.32    |
|   | For apprentice rates see "Apprentice- LINEMAN" |           |         |         |                           |            |

| Classification   | Effective Date | Base Wage | Health | Pension | Supplemental Unemployment | Total Rate |
|--|----------------|-----------|--------|---------|---------------------------|------------|
| JOURNEYMAN LINEMAN<br><i>OUTSIDE ELECTRICAL WORKERS - EAST LOCAL 104</i> | 08/30/2020     | \$49.45   | \$9.25 | \$17.48 | \$0.00                    | \$76.18    |

**Apprentice - LINEMAN (Outside Electrical) - East Local 104**

**Effective Date - 08/30/2020**

| Step | percent | Apprentice Base Wage | Health | Pension | Supplemental Unemployment | Total Rate |
|------|---------|----------------------|--------|---------|---------------------------|------------|
| 1    | 60      | \$29.67              | \$9.25 | \$3.39  | \$0.00                    | \$42.31    |
| 2    | 65      | \$32.14              | \$9.25 | \$3.46  | \$0.00                    | \$44.85    |
| 3    | 70      | \$34.62              | \$9.25 | \$3.54  | \$0.00                    | \$47.41    |
| 4    | 75      | \$37.09              | \$9.25 | \$5.11  | \$0.00                    | \$51.45    |
| 5    | 80      | \$39.56              | \$9.25 | \$5.19  | \$0.00                    | \$54.00    |
| 6    | 85      | \$42.03              | \$9.25 | \$5.26  | \$0.00                    | \$56.54    |
| 7    | 90      | \$44.51              | \$9.25 | \$7.34  | \$0.00                    | \$61.10    |

**Notes:**

**Apprentice to Journeyworker Ratio:1:2**

|   |            |         |        |        |        |         |
|---|------------|---------|--------|--------|--------|---------|
| TELEDATA CABLE SPLICER<br><i>OUTSIDE ELECTRICAL WORKERS - EAST LOCAL 104</i>                | 02/04/2019 | \$30.73 | \$4.70 | \$3.17 | \$0.00 | \$38.60 |
| TELEDATA LINEMAN/EQUIPMENT OPERATOR<br><i>OUTSIDE ELECTRICAL WORKERS - EAST LOCAL 104</i>   | 02/04/2019 | \$28.93 | \$4.70 | \$3.14 | \$0.00 | \$36.77 |
| TELEDATA WIREMAN/INSTALLER/TECHNICIAN<br><i>OUTSIDE ELECTRICAL WORKERS - EAST LOCAL 104</i> | 02/04/2019 | \$28.93 | \$4.70 | \$3.14 | \$0.00 | \$36.77 |

**Additional Apprentices Information:**

Minimum wage rates for apprentices employed on public works projects are listed above as a percentage of the pre-determined hourly wage rate established by the Commissioner under the provisions of the M.G.L. c. 149, ss. 26-27D. Apprentices ratios are established by the Division of Apprenticeship Training pursuant to M.G.L. c. 23, ss. 11E-11L.

All apprentices must be registered with the Division of Apprenticeship Training in accordance with M.G.L. c. 23, ss. 11E-11L.

All steps are six months (1000 hours.)

Ratios are expressed in allowable number of apprentices to journeymen or fraction thereof, unless otherwise specified.

\*\* Multiple ratios are listed in the comment field.

\*\*\* APP to JM; 1:1, 2:2, 2:3, 3:4, 4:4, 4:5, 4:6, 5:7, 6:7, 6:8, 6:9, 7:10, 8:10, 8:11, 8:12, 9:13, 10:13, 10:14, etc.

\*\*\*\* APP to JM; 1:1, 1:2, 2:3, 2:4, 3:5, 4:6, 4:7, 5:8, 6:9, 6:10, 7:11, 8:12, 8:13, 9:14, 10:15, 10:16, etc.

DOCUMENT A00801

**SPECIAL PROVISIONS****FITCHBURG****Bridge Rehabilitation, F-04-010, River Street (ST 31) over North Nashua River**

Labor participation goals for this Project shall be 15.3% for minorities and 6.9% for women for each job category. The goals are applicable to both Contractor's and Subcontractor's on-site construction workforce. Refer to Document 00820 for details.

**SCOPE OF WORK**

Work under this Contract consists of furnishing all materials, labor, and equipment required to replace superstructure of Bridge No. F-04-010 carrying River Street over North Nashua River. The new superstructure will closely match the existing alignment and profile.

This work will include the demolition and disposal of the existing bridge superstructure and other infrastructure; construction of the new bridge superstructure and substructure, including endposts and railings; construction of a temporary utility bridge to provide temporary utility by-pass; modifications to the existing drainage systems; rerouting water line onto bridge; supporting communications duct banks in place during construction; full-depth pavement reconstruction; pavement milling and overlays; construction of new cement concrete sidewalks, driveways, and pedestrian curb ramps; installation of traffic signs, and pavement markings; removing and resetting or installing new granite curb; setup and maintenance of temporary traffic control measures as required to complete the work; coordination with private utility companies who will be making modifications to existing utilities, including telephone, gas, and electrical services through force accounts; and all other incidental work as shown on the Contract Drawings, as specified in MassDOT standards and herein, and as otherwise required by the Engineer.

All work under this Contract shall be done in conformance with the *2023 Standard Specifications for Highways and Bridges*, the *Supplemental Specifications* contained in this book, the *2017 Construction Standard Details*, the *Traffic Management Plans and Detail Drawings*, *MassDOT Work Zone Safety Temporary Traffic Control*, the *1990 Standard Drawings for Signs and Supports*; the *2015 Overhead Signal Structure and Foundation Standard Drawings*, the *2009 Manual on Uniform Traffic Control Devices (MUTCD)* with Massachusetts Amendments; the *1968 Standard Drawings for Traffic Signals and Highway Lighting*; *The American Standard for Nursery Stock*; the Plans and these Special Provisions.

## **SUBSECTION 7.05 INSURANCE REQUIREMENTS**

### **B. Public Liability Insurance**

The insurance requirements set forth in this subsection are in addition to the requirements of the Standard Specifications and supersede all other requirements.

#### **Paragraphs 1 and 2**

The Massachusetts Department of Transportation and applicable railroads shall be named as additional insureds.

#### **Paragraph 4**

Asbestos Liability Insurance shall be obtained for this project. The Contractor and the Massachusetts Department of Transportation shall be named as additional insureds.

## **CONTRACTOR QUESTIONS AND ADDENDUM ACKNOWLEDGEMENTS**

Prospective bidders are required to submit all questions to the Construction Contracts Engineer by 3:00 P.M. on the Tuesday of the previous week before the scheduled bid opening date. Any questions received after this time will not be considered for review by the Department.

Contractors should email questions and addendum acknowledgements to the following email address [massdotSpecifications@dot.state.ma.us](mailto:massdotSpecifications@dot.state.ma.us) The MassDOT project file number and municipality is to be placed in the subject line.

## **SECTION 6.00: CONTROL OF MATERIALS**

### **Subsection 6.01: Source of Supply and Quality**

*Replace this subsection with the following:*

The Engineer may approve material at the source of supply before delivery to the project.

The Department reserves the right to require approval of the source of supply for any material to be incorporated into the work prior to delivery or manufacture.

The Engineer reserves the right to prohibit the use of materials, products, or components which, in their opinion, may be supplied in a manner not reasonably consistent with contract requirements.

The determination of the Engineer shall be final upon all questions which pertain to supplier approval.

Fabricators of structural steel, miscellaneous steel and aluminum products, and producers of precast concrete and prestressed concrete must be on the Department's approved fabricators list on the date the bids are opened. Only approved fabricators will be allowed to perform work for the Department.

The Contractor shall furnish all materials required for the work specified in the Contract. Said materials shall meet the requirements of the specifications for the kind of work involving their use. For any materials named or described in these specifications, an approved equivalent to that named or described in the said specifications, may be furnished.

Chapter 7, Section 22, Clause 17, of the General Laws, as amended, shall apply to the purchase by the Contractor of supplies and materials to be used in the execution of this Contract.

The rules referred to require a preference in the purchase of supplies and materials, other considerations being equal, in favor first, of supplies and materials manufactured and sold within the Commonwealth, and second, of supplies and materials manufactured and sold within the United States.

**SECTION 6.00** (Continued)

All iron and steel products, manufactured products, and construction materials shall comply with all Federal Buy America and Federal Build America Buy America (BABA) requirements, where applicable.

In Contracts requiring structural steel, precast, or prestress concrete, the Contractor shall furnish approved shop drawings, and fabrication procedures to the Department's inspector at the supply source or fabrication site. Materials for permanent construction shall be new, shall conform to the requirements of these specifications, and shall be approved by the Engineer.

Materials for temporary structures or supports adjacent to traveled ways, the failure of which would compromise the safety of the public or the traveled ways, need not be new but the Contractor shall be required to submit certification by a Structural Professional Engineer that the material meets the requirements for the intended use and shall be approved by the Engineer. Any fabrication shall conform to the requirements of these specifications. These requirements shall not apply to gantry systems and supports as well as other mechanized systems.

If testing finds that an approved supplier does not furnish a uniform product, or if the product from such source proves unacceptable at any time, the Contractor shall, at their own expense, take any and all steps necessary to furnish approved materials.

The Contractor shall submit to the Department for approval a notarized Certificate of Compliance (COC) from the Manufacturer or Supplier for each kind of manufactured or fabricated material furnished.

The COC shall certify compliance with the specifications and shall contain the following information:

1. Contract Number, City or Town, Name of Road and Federal Aid Number;
2. Name of the Contractor to which the material is supplied;
3. Kind of material supplied;
4. Quantity of material represented by the certificate;
5. Means of definitively identifying the consignment, such as invoice number, lot number, bill of lading number, label, marking, etc.;
6. Date and method of shipment;
7. Statement indicating that the material has been tested and found in conformity with the pertinent parts of the Contract;
8. Statement indicating that the material meets the requirements of Buy America and BABA, where applicable;
9. Results of all required tests including the chemical analysis in the case of metal: or in lieu of furnishing the results a statement that results of all required tests pertinent to the certificate and not submitted shall be maintained available by the undersigned for a period of not less than three years from date of final acceptance or not less than three years from date of final payment (whichever period is the longest shall apply).
10. Signature of a person having legal authority to bind the supplier.

---

**SECTION 6.00** (Continued)

These COCs shall be delivered to the contract site at the same time that the materials are delivered and before such materials are incorporated into the work. The Contractor shall attach to the COC a document listing the contract bid item number(s), sub item(s), or lump sum breakdown item number(s), as applicable, under which the material will be compensated. Payment for the item in which the materials are incorporated may be withheld until these COCs are received in a form that meets the contract requirements.

If the Contractor has new materials purchased for use on a previous Department Contract which have never been used and which comply with the specifications, these materials may be furnished and used. The Contractor shall submit their own sworn statement certifying that such materials were purchased for use on a previous Contract (naming and identifying such Contract) and shall attach the original COC.

Any cost involved in furnishing the certificate shall be borne by the Contractor.

**Subsection 6.03: Delivery and Storage of Materials**

*Replace this Subsection with the following:*

Materials and equipment shall be progressively delivered to or removed from the site so that there will be neither delay in the progress of the work nor an accumulation of materials that are not to be used or removed within a reasonable time. All materials shall be stored in pre-approved locations per the conditions of the property owner.

Delivered materials and materials originating from the site, shall be stored to assure the preservation of their quality and fitness for the work. Stored materials, even though approved before storage, may again be inspected prior to their use in the work. Stored materials shall be located to facilitate their prompt inspection.

Approved portions of the State Highway Layout (SHLO) may be used for storage of project materials and for the placing of the Contractor's plant and equipment upon obtaining a state highway access permit. All storage sites shall be restored to their original condition by the Contractor. No additional compensation shall be given for the design, construction, preparation, or restoration of the storage site(s) or obtaining the access permit which may include but is not limited to a Traffic Management Plan (TMP), utilities, and lighting.

The application for a permit shall contain a locus map identifying the proposed location, a description of the specific activities and uses of the staging area, a TMP in accordance with Subsection 7.10 depicting minimum setbacks from the roadway and any existing structures for stored materials and equipment and how equipment will safely access and exit the staging area.

Any additional space required must be provided by the Contractor at their expense. Municipal, private, or other state-owned property shall not be used for storage purposes without written permission of the owner or lessee, and copies of such written permission shall be furnished to the Engineer.

## **WORK SCHEDULE**

The schedule of operations is anticipated to follow a normal 8-hour day, 5-day week from 7:00 AM to 3:30 PM.

A lane carrying southbound traffic shall be maintained at all times unless approved in writing by the Engineer. Northbound traffic shall be detoured as shown in the plans.

One sidewalk shall be maintained at all times for pedestrians.

## **HOLIDAY WORK RESTRICTIONS**

(Supplementing Subsection 7.09)

The District Highway Director (DHD) may authorize work to continue during these specified time periods if it is determined by the District that the work will not negatively impact the traveling public. DHD may allow work in those areas on a case by case basis and where work is behind barrier and will not impact traffic

Below are the holiday work restrictions:

### New Years Day (Federal Holiday)

No work on major arterial roadways from 5:00 AM on the day before until the normal start of business on the next subsequent business day. No work on local roadways on the holiday without permission by the DHD and the local police chief.

### Martin Luther King's Birthday (Federal Holiday)

No work restrictions due to traffic concerns, however work on local roadways requires permission by the DHD and local police chief.

### President's Day (Federal Holiday)

No work restrictions due to traffic concerns, however work on local roadways requires permission by the DHD and local police chief.

### Evacuation Day (Suffolk County State Holiday)

No work restrictions due to traffic concerns.

### Patriot's Day (State Holiday)

Work restrictions will be in place for Districts 3 and 6 along the entire Boston Marathon route and any other locations that the DHD in those districts determine are warranted so as to not impact the marathon. All other districts work restrictions will be as per DHD.

### Mother's Day

No work on Western Turnpike and Metropolitan Highway System from 5:00 AM on the Friday before, until the normal start of business on the following day.



## **HOLIDAY WORK RESTRICTIONS** (Continued)

### Memorial Day (Federal Holiday)

No work on major arterial roadways from 5:00 AM on the Friday before, until the normal start of business on the following day.

### Bunker Hill Day (Suffolk County State Holiday)

No work restrictions due to traffic concerns.

### Juneteenth

No work restrictions due to traffic concerns, however work on local roadways requires permission by the DHD and local police chief.

### Independence Day (Federal Holiday)

No work on major arterial roadways from 5:00 AM on the day before until the normal start of business on the next subsequent business day. No work on local roadways on the holiday without permission by the DHD and the local police chief.

### Labor Day (Federal Holiday)

No work on major arterial roadways from 5:00 AM on the Friday before, until the normal start of business on the following day.

### Columbus Day (Federal Holiday)

No work on major arterials from 5:00 AM on the Friday before, until the normal start of business on the following day

### Veterans' Day (Federal Holiday)

No work restrictions due to traffic concerns.

### Thanksgiving Day (Federal Holiday)

No work on major arterials from 5:00 AM two days before until the normal start of business on the following Monday.

### Christmas Day (Federal Holiday)

No work on major arterial roadways from 5:00 AM on the day before until the normal start of business on the next subsequent business day.

**COMPLIANCE WITH THE NATIONAL DEFENSE AUTHORIZATION ACT**

(Supplementing Subsection 7.01)

On all projects, the “Prohibition on Certain Telecommunications and Video Surveillance Services or Equipment” Regulation (2 CFR 200.216) prohibits the Contractor from using or furnishing the following telecommunications equipment or services:

- Telecommunications equipment produced by Huawei Technologies Company or ZTE Corporation (or any subsidiary or affiliate of such entities).
- For the purpose of public safety, security of government facilities, physical security surveillance of critical infrastructure, and other national security purposes, video surveillance and telecommunications equipment produced by Hytera Communications Corporation, Hangzhou Hikvision Digital Technology Company, or Dahua Technology Company (or any subsidiary or affiliate of such entities).
- Telecommunications or video surveillance services provided by such entities or using such equipment.
- Telecommunications or video surveillance equipment or services produced or provided by an entity that the Secretary of Defense, in consultation with the Director of the National Intelligence or the Director of the Federal Bureau of Investigation, reasonably believes to be an entity owned or controlled by, or otherwise connected to, the government of a covered foreign country.

This prohibition applies to all products manufactured by the aforementioned companies, including any individual components or parts.

By submitting a bid on a project, the Contractor certifies that all work will be in compliance with the terms of 2 CFR 200.216. The Contractor shall submit a COC indicating compliance with the above provisions for all telecommunications equipment or services included in the Contract.

Payment for the item in which the materials are incorporated may be withheld until these COCs are received. Any cost involved in furnishing the certificate(s) shall be borne by the Contractor.

**AFFECTED UTILITY COMPANIES**

(Supplementing Subsection 7.13)

The following are the names of owners and representatives of the principal utilities that may be affected, but completeness of this list is not guaranteed by the Department:

Electric

Unitil, Fitchburg Gas & Electric  
357 Electric Avenue  
Lunenburg, MA 01462  
Attn: Mark Frappier  
978-353-3217  
[frappier@unitil.com](mailto:frappier@unitil.com)

Water

Fitchburg Water Department  
1200 Rindge Road  
Fitchburg, MA 01420  
Attn: John M. Deline  
978-345-9616 x109  
[jdeline@fitchburgma.gov](mailto:jdeline@fitchburgma.gov)

Gas

Unitil, Fitchburg Gas & Electric  
357 Electric Avenue  
Lunenburg, MA 01462  
Attn: Daniel Golden  
978-353-3245  
[golden@unitil.com](mailto:golden@unitil.com)

Sewer

Fitchburg DPW  
301 Broad Street  
Fitchburg, MA 01420  
Attn: Gary Belivacqua  
978-345-9613

Telephone

Verizon  
385 Myles Standish Blvd.  
Taunton, MA 02780  
Attn: Karen Mealey  
774-409-3160  
[karen.m.mealey@verizon.com](mailto:karen.m.mealey@verizon.com)

Cable

Crown Castle  
80 Central Street  
Boxborough, MA 01719  
Attn: Mark Bonanno  
508-616-7818  
[mark.bonanno@crowncastle.com](mailto:mark.bonanno@crowncastle.com)

UNITIL Emergency Telephone Numbers

Gas:  
Outage/ Emergency: 888-301-7700  
New Service: 1-888-486-4845  
Customer Support: 888-301-7700

Electric:  
Outage/ Emergency: 888-301-7700  
New Service: 888-301-7700  
Customer Support: 888-301-7700

---

**MASSACHUSETTS DEPARTMENT OF ENVIRONMENTAL PROTECTION FILE NUMBER SIGN**

This project is subject to Massachusetts General Laws, Chapter 131, Section 40 as amended. Signs shall be in accordance with the latest MassDOT Construction Standards. All costs for the manufacture, erection, maintenance, moving, and removal of the signs shall be absorbed by the contractor with no additional compensation other than the contract unit prices.

The Massachusetts Department of Environmental Protection File Number is 155-731 for this project.

**NORTHERN LONG-EARED BAT PROTECTION**

The U.S. Fish and Wildlife Service (USFWS) has listed the northern long-eared bat (NLEB) as endangered under the Endangered Species Act (ESA) and the following requirements exist to protect the bat and its habitat. This project has been consulted with the USFWS through the Federal Highway Administration (FHWA), Federal Railroad Administration (FRA), and Federal Transit Administration (FTA) Programmatic Biological Opinion for Transportation Projects in the Range of the Indiana Bat and Northern Long-Eared Bat revised February 5, 2018 and amended March 31, 2023.

On behalf of FHWA, the lead federal agency for Section 7 consultation, MassDOT submitted a Programmatic Consultation for Transportation Projects affecting NLEB or Indiana Bat to the USFWS through the Information for Planning and Consultation (IPaC) webpage and generated a USFWS No Effect Consistency Letter (see Document A00871), whereby it was determined that this Project will have “No Effect” to the NLEB. Therefore, the project has completed Section 7 consultation through the Endangered Species Act, and no AMMs apply to the project.

If the project scope changes (i.e., tree clearing, bridge work), additional review is required by the MassDOT Highway Division’s Environmental Services Section. Contact MassDOT Environmental Services - Wildlife & Endangered Species Unit Supervisor (David Paulson, [david.j.paulson@dot.state.ma.us](mailto:david.j.paulson@dot.state.ma.us), 857-262-3378).

**EMERALD ASH BORER ADVISORY**

To the extent possible, all trees and brush shall be disposed on site, typically chipped and spread in place. When trees or brush must be removed, such as in urban, or otherwise populated areas, Contractor shall identify proposed location for disposal, and provide written notification to the Engineer for approval. Disposal shall be in city or town of project, or at minimum, within county, of construction operations.

---

## **ENVIRONMENTAL PERMITTING**

An Order of Conditions has been obtained from the Fitchburg Conservation Commission under the Wetlands Protection Act and Section 404 authorization under the Clean Water Act has been obtained from the US Army Corps of Engineers. If field conditions and/or Contractor-proposed erection, demolition, storage, or other procedures not originally allowed by existing environmental permits require work to occur in or otherwise impact water or wetland resource areas, the Contractor is advised that no associated work can occur until all required environmental permits have been either amended or obtained allowing such work. The Contractor must notify the District 3 Highway Director and Resident Engineer in writing at least 60 days prior to desired commencement of the proposed activity. All environmental submittals, including any contact with Local, State, or Federal environmental agencies, must be coordinated with the District 3 Environmental Engineer. The Contractor is expected to fully cooperate with requests for information and provide same in a timely manner. The Contractor is further advised that the Department will not entertain a delay claim due to the time required to modify or obtain the environmental permits.

## **CONTAMINATED SOIL**

Soil to be removed from the project area shall not be assumed to be uncontaminated and must be evaluated prior to off-site management for potential contamination with hazardous materials. No soil may be disposed of off-site without proper assessment by the contractor and approval from the Resident Engineer (RE), District Environmental Engineer (DEE), or the project designee.

## **SOIL STOCKPILING DIRECTIVE P-22-001**

Any stockpiling of soil must be performed in compliance with Policy Directive P-22-001, Off-Site Stockpiling of Soil from MassDOT Construction Projects. This directive limits the allowable locations for off-site stockpiling of soil generated during MassDOT projects and includes various requirements that must be satisfied by the contractor prior to off-site stockpiling

## **EQUIVALENT SINGLE AXLE LOADS (ESALS)**

The estimated traffic level to be used for SUPERPAVE HMA mixture designs for this contract, expressed in Equivalent Single Axle Loads (ESALs) for the design travel lane over a 20-year period, is 2.8 Million 18-kip (80-kn) ESALs.

## **PIGEON WASTE**

The Contractor shall remove and dispose of the pigeon waste and any other debris accumulated on the steel members and bridge seats in areas where work is being performed. Pigeon waste and debris material contaminants will require special handling and disposal in accordance with all Federal, state, and local requirements. No separate payment will be made for removal and disposal of pigeon waste. Cost shall be incidental to the contract pay items.

---

**GENERAL REQUIREMENTS FOR DEMOLITION AND  
WORK INVOLVING PAINTED STEEL**

(02/06/2020)

Demolition and work involving painted steel shall conform to the requirements of Subsection 961 of the Standard Specifications.

**Work Involving Painted Steel.**

Hazardous materials shall be removed in the immediate area of any intended welding, heating, saw cutting or burning of steel. Hazardous material removal is required to allow the demolition of structural steel, railings, drainage systems, utility supports, steel lamp posts, etc.

The contractor shall assume that the coatings on the steel contain lead (Pb), unless otherwise determined by testing. The contractor shall certify in writing to the Engineer the results of all testing, and shall also certify that any lead (Pb) coated steel removed from the project was not reused or buried, but was sent to a scrap metal recycling facility.

Implement and maintain programs and procedures, which comply with the requirements of this specification and all applicable standards and regulations. Comply with all applicable regulations even if the regulation is not specifically referenced herein. If a state or local regulation is more restrictive than the regulation of this specification, follow the more restrictive requirements.

This requirement is intended only for the demolition and preparation prior to repair and does not include provisions for recoating of steel.

**Environmental**

All applicable portions of Subsections 961.65 “Worker Protection” and 961.66 “Environmental Protection and Monitoring” shall be followed when performing this work.

During chemical stripping a hand washing facility may be used in lieu of a decontamination/changing facility.

Hazardous material shall be collected during the disassembly and disposed of as outlined in Subsection 961.68 “Handling of Hazardous Waste and Reporting Release Programs”.

The applicable submittals shall be according to Subsection 961.69 “Submittals”.

---

**GENERAL REQUIREMENTS FOR DEMOLITION AND WORK INVOLVING PAINTED STEEL** (Continued)**Cleaning/Removal****Cutting Or Burning Of Steel**

All surfaces to be welded, heated, saw cut or burned shall be cleaned so as to remove all contaminants and/or hazardous materials, which could be discharged to the environment as a function of the subsequent operations.

Lead paint shall be removed in its entirety in an area prescribed by a 6 inch (15 cm) minimum offset from the required work. The paint removal operation may be dry abrasive blasting, wet abrasive blasting or chemical stripping.

Proper level of containment shall be used when performing this work in accordance with Subsection 961.67 "Containment". Full containment is not required during chemical stripping operation however; the Contractor shall install proper shielding and/or tarpaulins under the chemical stripping operations in order to catch all debris generated during this procedure. A cleaned area must be inspected and approved before the demolition operations are started.

During cleaning operations the Contractor shall be required to furnish and erect temporary floodlights illuminating the steel surface at a minimum of 30-foot candles. This lighting shall be used in areas where there is insufficient lighting for proper cleaning operations and inspection. The Contractor shall supply electrical power.

The Contractor shall provide support for interim and final inspection of the bridge during cleaning operations. This support shall include the necessary traffic controls and safe access to the work.

**Mechanical Disassembly Of Steel**

All surfaces to be mechanically disassembled by shear cutting or removing bolts or rivets shall not require deleading. When shear cutting or removing bolts or rivets, the Contractor shall not use any method that will cause dust and/or particles to be emitted and/or dispersed into the environment to an extent that would expose the workers above the Action Levels of  $30\mu\text{g}/\text{m}^3$ .

For purposes of limiting the lead (Pb) dust, the Contractor will be required to dampen the lead paint work areas.

The contractor shall install a proper shielding and/or tarpaulins under all lead-paint-coated surfaces to be shear cut or bolts or rivets ordered removed in order to catch any loose lead paint chips, dust or particles.

## **VALUE ENGINEERING CHANGE PROPOSAL**

This Subsection defines the conditions and requirements which apply to Value Engineering Change Proposals (“VECPs”). The purpose of this provision is to encourage the Contractor to propose changes in certain project requirements that will maintain the project’s functional requirements at a savings in contract time, contract price, or both. The net savings obtained by using a VECP that meets the conditions and requirements set forth here will be shared by the Contractor and MassDOT.

VECP’s under this provision are to be initiated, developed and submitted to MassDOT by the Contractor. The VECP must show the contemplated changes to the Drawings, Specifications and other requirements in the Contract. When a VECP submitted pursuant to this section is fully accepted by MassDOT, the VECP will be implemented by the Contractor and paid using the current cost and resource loaded schedule. Contractor shall demonstrate that the VECP is equal to, or better than, the original design or material; that there is an interest in public safety within the VECP; that there is a life-cycle cost benefit; and/or that end users will benefit from the shortened schedule. VECPs shall be consistent with the MassHighway/MassDOT Standard Specifications for Highways and Bridges and other applicable reference documents and directives. Any proposed deviation from these documents will need to be clearly identified in the VECP Proposal Documents, and must be approved by MassDOT’s Chief Engineer before accepting this VECP.

A. In order to be considered for MassDOT review each VECP shall:

1. Be clearly labeled pursuant to this Subsection;
2. Yield a net savings at least two hundred and fifty thousand (250,000.00) Dollars and/or a net saving of contract completion duration of at least three (3) months;
3. The proposed changes to contract items must:
  - a. maintain the specified items’ required functions (service life, reliability);
  - b. meet applicable safety regulations and codes;
  - c. material substitutions must be in accordance with DOT prequalified/preapproved products and must be tested in accordance with standard material specs/testing methods ( and considering all relevant environmental, load, and other relevant factors);
  - d. show economy of operation, ease of maintenance, ease of construction, and necessary standardized features and appearance; and
4. Shall not require an extension of Contract Time or Contract Milestones, with the exception of cases when there are anticipated significant cost saving.



---

**VALUE ENGINEERING CHANGE PROPOSAL** (Continued)

The thresholds above are considered to be a general guideline. MassDOT will consider VECPs outside of these thresholds if a significant benefit is demonstrated. Additionally, notwithstanding this VECP process, MassDOT will consider minor revisions in the form of a Contract Modification.

Further, any VECP submitted shall be in sufficient detail to clearly define the proposed change. The Contractor's failure to provide information of the type, detail and in a format to facilitate the MassDOT's review, may be grounds for rejection of the VECP. Additionally, the Contractor will not be entitled to any equitable adjustment or increased Time, due to any aspect of any of the proposed VECP including permitting, right of way, utility coordination or delayed responses by MassDOT. If, after the progression of the work associated with the executed Contract Modification for the VECP, any additional costs are realized by the Contractor or any of the sub-consultants, sub-contractors, or suppliers, the Contractor shall be obligated to pay for any and all costs.

- B. The following initial items shall be provided by the Contractor for MassDOT's review. *Items 1-6 need to be submitted prior to the start of MassDOT's review of the VECP and item 7 is an important consideration for the pricing of the VECP and the timeline of the proposed VECP schedule.*
1. ***VECP Description:*** A description of the difference between the existing and the proposed Contract requirements, and the comparative advantages and disadvantages of each;
  2. ***VECP Change Listing:*** A listing of the Contract requirements that will need to be changed, modified, or reviewed as well as the proposed Contract document changes in the Instructions to Bidders, Contract, Standard Specifications, General Requirements and Special Provisions required by the VECP.
  3. ***Construction Schedule Update:*** Any changes in the Contract Time(s) or Contract Milestone(s), that will result from acceptance of the VECP, shall be accompanied by a contemporaneous schedule analysis (*i.e., the Contractor's baseline schedule submission, all past/required monthly schedule updates, a detailed assessment of all past delays, and a resource loaded Critical Path Method schedule as specified in Section 8.0 / Subsection 8.02 of this Contract*) of the projected Work that remains including the proposed VECP related schedule changes (*inclusive of the timeline to review accept the VECP and the timeline for implementing the design changes*) in the remaining work. This shall be submitted in the form of a Proposal Schedule until the VECP has been formally accepted. Note: All of this information is to be updated, recertified, and formally accepted by MassDOT before final acceptance of this this VECP is issued.

---

**VALUE ENGINEERING CHANGE PROPOSAL** (Continued)

4. ***Date for MassDOT's Acceptance:*** A statement that clearly justifies the date by which the VECP must be accepted to obtain the maximum price reduction, noting any effect upon the Contract Time(s) and/or Contract Milestone(s). This statement must include a narrative that demonstrates the most recent construction schedule has been utilized to justify that proposed acceptance date (*e.g. "in order to start to fabricate critical materials, authorization must be provided to work on the shop drawings by no later than [date]"*). The Contractor should allow for at least sixty (60) to ninety (90) days for acceptance by MassDOT once all of the VECP documentation has been provided. Acceptance shall mean that MassDOT has received a finalized and executed contract modification. However, this is a proposed Contract change.

The Contractor is fully obligated to progress the Work of the original Contract and MassDOT is not liable for any delays or costs that may occur in the review phase of any VECP proposal.

5. ***Cost and Savings Estimates:*** A detailed estimate of the anticipated net savings, calculated as follows:
- a. ***Original Scope:*** Isolate the cost of performing the original contract construction activities, in accordance with the original Contract Documents, as originally bid by the Contractor, that are anticipated to be superseded by the VECP. *This cost is to include any original contract scope that is anticipated to be altered or eliminated by the VECP such as, shop drawing preparation, inspection work, testing, maintenance of traffic, or any other original contract costs, that have yet to have been performed at the time of this VECP submission.*
  - b. ***New VECP Scope:*** Calculate the cost of performing the comparable construction activities associated with the VECP.
  - c. ***Contractor's Engineer & Inspection:*** Calculate the cost of engineering, inspection, and design work by the Contractor's Engineer/Designer. This should be a realistic estimate of the costs of any required engineering, design and review work by the Contractor's Engineer.
  - d. ***MassDOT's Costs:*** MassDOT's estimate of costs to perform engineering/design reviews, cost estimate reviews, schedule reviews, and any other administrative costs to review and recommend implementation of the proposed VECP. (*including all anticipated increased costs to MassDOT on other Contracts and all anticipated follow-on increased costs to MassDOT, if any*) as provided by MassDOT. MassDOT's estimated costs must be included the VECP calculation and will be provided by MassDOT in support of the VECP evaluation process.
  - e. ***Other Costs:*** Estimated costs associated with any revisions to other project related costs, such as Environmental Permits or Right of Way acquisitions, including other agency or municipality costs, as provided by MassDOT.

---

**VALUE ENGINEERING CHANGE PROPOSAL** (Continued)Net Savings:

**The net savings to be split between MassDOT and the Contractor shall be calculated using the items above as follows:  $a - (b+c+d+e) = \text{net savings}$**

6. *The Contractor shall also provide:*

- a. A proposed Change Order, which explains and justifies any required Equitable Adjustment in the Contract Price.
- b. The Contractor's actual costs expended for developing the VECP as of the date of the VECP submission;

7. ***Design Changes and Drawings:*** The costs that are outlined above should be inclusive of the following design and engineering responsibilities.

- a. Design changes shall be prepared and stamped by the Contractor's professional designer and/or engineer. In addition, in the development of the VECP; the Contractor is responsible for anticipating and managing all aspects associated with any VECP design work that must be performed by a licensed Engineer.
- b. The Contractor's engineer must analyze and stamp all components of any aspect of the project that has been redesigned, changed, or altered as a result of this VECP.
- c. The Contractor's engineer shall provide all calculations and supporting design/engineering documentation that was utilized to develop the changes and stamped drawings. These will be used by MassDOT's Designer-of-Record to review the VECP changes. The Contractor is limited to selecting only those engineer's that have been pre-qualified by MassDOT's A&E Board.
- d. MassDOT's Designer-of-Record will review and respond to all completed design submissions related to this VECP within thirty (30) calendar days, unless determined to be a non-critical path item.
- e. MassDOT will be responsible for estimating and managing MassDOT's Designer-of-Record during the VECP review and implementation. Should any significant conflicts arise, between the Contractor's Engineer and MassDOT's Designer-of-Record, the DOT and the Contractor will work expeditiously to resolve the conflict. Should this type of conflict continue for greater than five (5) days, the Contractor is to bear all financial and time related impacts of such delay and must seek to resolve the design conflict, in an acceptable manner to MassDOT. The resolution of this conflict will be funded at the Contractor's expense – exclusive of the net saving that was agreed to at the execution of the contract modification for this VECP.
- f. The Contractor's Engineer may also be required to inspect the construction work. The Contractor is to include such anticipated inspection costs in the initial VECP.

---

**VALUE ENGINEERING CHANGE PROPOSAL** (Continued)

- g. MassDOT's Designer of Record will remain the Designer-of-Record for the entire Project. Any costs incurred in the use of MassDOT's Designer-of-Record by MassDOT or Contractor associated with the review of a VECP are to be included in the calculated net savings.
- C. Approval of the VECP shall not occur until a Contract Modification, incorporating the VECP, is issued by MassDOT and properly executed by the Contractor. MassDOT may accept or reject part or all of any VECP at any time prior to an executed Contract Modification for the applicable VECP. The decision of MassDOT, concerning acceptance or rejection of any VECP, shall be final and shall not be subject to dispute resolution.

It is expected that several weeks may go by before the final VECP documentation has been executed with a Contract Modification. Therefore, MassDOT intends to make certain that the initial cost estimate information has not changed before entering into a Contract Modification. As the VECP evaluation process is finalized, and prior to the signed Contract Modification for the VECP, the Contractor and MassDOT must re-certify the current status of the originally proposed cost and/or schedule savings.

Until a contract modification is issued and schedule and cost/savings re-certification is complete and accepted by MassDOT, the Contractor shall remain obligated to perform the Work in accordance with the terms and conditions of the original Contract Documents.

Upon completion of the work associated with the VECP, MassDOT may require verification that the VECP savings has been achieved.

- D. VECPs will be processed (distributed, reviewed, commented upon, accepted or rejected) expeditiously (pursuant to M.G.L. c. 30, § 39R); however, as this is an elective modification to the contract, MassDOT shall not be liable for any delay or cost in the review and acceptance of the VECP. During the review of the VECP, the Contractor remains obligated to progress the original Contract scope, and schedule, as planned; until a Contract Modification, accepting the Contractor re-certified VECP, has been executed by MassDOT.

The Contractor has the right to withdraw part, or all of any VECP, prior to acceptance by MassDOT. Such withdrawal shall be made in writing to the Engineer. The Contractor shall state the period of time, from the date of the initial VECP submittal, that the VECP shall remain valid and feasible. Revision of this validity and feasibility period shall be allowed only by mutual agreement of the Contractor and the Engineer in writing.

If the Contractor desires to withdraw the proposal prior to the expiration of this period for non-technical reason, MassDOT reserves the right to recover all actual costs that have been incurred to MassDOT.

**VALUE ENGINEERING CHANGE PROPOSAL** (Continued)

If the Contractor withdraws the VEC Proposal, MassDOT reserves the right to proceed with the VECP or any portion of the VECP as a normal change and the Contractor waives any right it may have had to share in net savings thereunder.

For purposes of this provision, expiration of the time established by the Contractor for approval shall be considered as withdrawal by the Contractor if MassDOT requests an extension of that time and the Contractor does not provide a written extension.

- E. With regard to unknown conditions or sub-surface work, in general, the expectation is that the Contractor and MassDOT will strive to gain enough knowledge about the risks in order to provide a forward-priced Change Proposal. Therefore, any costs to fully evaluate the proposal, such as additional borings and/or test pits, must be considered in the cost evaluation of whether the VECP is worth pursuing. However, if it is impractical to gather conclusive exploratory information, before the VECP is executed, MassDOT may consider provisions in the VECP that clearly identifies the risk sharing (cost and time) related specifically to the unknown/sub-surface conditions. If these VECP provisions are acceptable to MassDOT they are to include supplemental language to provide a determination of the final savings/cost, and time impacts, no later than 45 days after the sub-surface work is completed. All other aspects of the VECP, unrelated to these Provisions, will be binding upon execution of the VECP.

---

## **SUBSECTION 8.14 UTILITY COORDINATION, DOCUMENTATION, AND MONITORING RESPONSIBILITIES**

### **A. GENERAL**

In accordance with the provisions of Section 8.00 Prosecution and Progress, utility coordination is a critical aspect to this Contract. This section defines the responsibility of the Contractor and MassDOT, with regard to the initial utility relocation plan and changes that occur as the prosecution of the Work progresses. The Engineer, with assistance from the Contractor shall coordinate with Utility companies that are impacted by the Contractor's operations. To support this effort, the Contractor shall provide routine and accurate schedule updates, provide notification of delays, and provide documentation of the steps taken to resolve any conflicts for the temporary and/or permanent relocations of the impacted utilities. The Contractor shall provide copies to the Engineer of the Contractor communication with the Utility companies, including but not limited to:

- Providing advanced notice, for all utility-related meetings initiated by the Contractor.
- Providing meeting minutes for all utility-related meetings that the Contractor attends.
- Providing all test pit records.
- Request for Early Utility work requirements of this section (see below).
- Notification letters for any proposed changes to Utility start dates and/or sequencing.
- Written notification to the Engineer of all apparent utility delays within seven (7) Calendar Days after a recognized delay to actual work in the field – either caused by a Utility or the Contractor.
- Any communication, initiated by the Contractor, associated with additional Right-of-Way needs in support of utility work.
- Submission of completed Utility Completion Forms.

### **B. PROJECT UTILITY COORDINATION (PUC) FORM**

The utility schedule and sequence information provided in the Project Utility Coordination Form (if applicable) is the best available information at the time of the bid and has been considered in setting the contract duration. The Contractor shall use all of this information in developing the bid price and the Baseline Schedule Submission, inclusive of the individual utility durations sequencing requirements, and any work that has been noted as potentially concurrent utility installations.

### **C. INITIATION OF UTILITY WORK**

The Engineer will issue all initial notice-to-proceed dates to each Utility company based on either the:

- 1) Contractor's accepted Baseline Schedule
- 2) An approved Early Utility Request in the form of an Early Utility sub-net schedule (in accordance with the requirements of this Subsection)
- 3) An approved Proposal Schedule

#### **C.1 - BASELINE SCHEDULE – UTILITY BASIS**

The Contractor shall provide a Baseline Schedule submission in accordance with the requirements of Subsection 8.02 and inclusive of all of the information provided in the PUC Form that has been issued in the Contract documents. This is to include the utility durations, sequencing of work, allowable concurrent work, and all applicable considerations that have been depicted on the PUC Form.

---

**SUBSECTION 8.14** (Continued)**C.2 – EARLY UTILITY REQUEST – (aka SUBNET SCHEDULE) PRIOR TO THE BASELINE**

All early utility work is defined as any anticipated/required utility relocations that need to occur prior to the Baseline Schedule acceptance. In all cases of proposed early utility relocation, the Contractor shall present all known information at the pre-construction conference in the form of a ‘sub-net’ schedule showing when each early utility activity needs to be issued a notice-to-proceed. The Contractor shall provide advance notification of this intent to request early utility work in writing at or prior to the Pre-Construction meeting. Prior to officially requesting approval for early utility work, the Contractor shall also coordinate with MassDOT and all utility companies (private, state or municipal) which may be impacted by the Contract. If this request is acceptable to the Utilities and to MassDOT, the Engineer will issue a notice-to-proceed to the affected Utilities, based on these accepted dates.

**C.3 – PROPOSAL SCHEDULE - CHANGES TO THE PUC FORM**

If the Contractor intends to submit a schedule (in accordance with MassDOT Standard Specifications, Division I, Subsection 8.02) that contains durations or sequencing that vary from those provided in the Project Utility Coordination (PUC) Form, the Contractor must submit this as an intended change, in the form of a Proposal Schedule and in accordance with MassDOT Standard Specifications, Division I, Subsection 8.02. These proposed changes are subject to the approval of the Engineer and the impacted utilities, in the form of this Proposal Schedule and a proposed revision to the PUC form. The Contractor shall not proceed with any changes of this type without written authorization from the Engineer, that references the approved Proposal Schedule and PUC form changes. The submission of the Baseline Schedule should not include any of these types of proposed utility changes and should not delay the submission of the Baseline Schedule. As a prerequisite to the Proposal Schedule submission, and in advance of the utility notification(s) period, the Contractor shall coordinate the proposed utility changes with the Engineer and the utility companies, to develop a mutually agreed upon schedule, prior to the start of construction.

**D. UTILITY DELAYS**

The Contractor shall notify the Engineer upon becoming aware that a Utility owner is not advancing the work in accordance with the approved utility schedule. Such notice shall be provided to the Engineer no later than seven (7) calendar days after the occurrence of the event that the Contractor believes to be a utility delay. After such notice, the Engineer and the Contractor shall continue to diligently seek the Utility Owner’s cooperation in performing their scope of Work.

In order to demonstrate that a critical path delay has been caused by a third-party Utility, the Contractor must demonstrate, through the requirements of the monthly Progress Schedule submissions and the supporting contract records associated with Subsection 8.02, 8.10 and 8.14, that the delays were beyond the control of the Contractor.

---

**SUBSECTION 8.14** (Continued)

All documentation provided in this section is subject to the review and verification of the Engineer and, if required, the Utility Owner. In accordance with MassDOT Specifications, Division I, Subsection 8.10, a Time Extension will be granted for a delay caused by a Utility, only if the actual duration of the utility work is in excess of that shown on the Project Utility Coordination Form, and only if;

- 1) proper Notification of Delay was provided to MassDOT in accordance with the time requirements that are specified in this Section
- 2) the utility delay is a critical path impact to the Baseline Schedule (or most recently approved Progress Schedule)

**E. LOCATION OF UTILITIES**

The locations of existing utilities are shown on the Contract drawings as an approximation only. The Contractor shall perform a pre-construction utility survey, including any required test pits, to determine the location of all known utilities no later than thirty (30) calendar days before commencing physical site work in the affected area.

**F. POST UTILITY SURVEY – NOTIFICATION**

Following completion of a utility survey of existing locations, the Contractor will be responsible to notify the Engineer of any known conflicts associated with the actual location of utilities prior to the start of the work. The Engineer and the Contractor will coordinate with any utility whose assets are to be affected by the Work of this Contract. A partial list of utility contact information is provided in the Project Utility Coordination Form.

**G. MEETINGS AND COOPERATION WITH UTILITY OWNERS**

The Contractor shall notify the Engineer in advance of any meeting they initiate with a Utility Owner's representative to allow MassDOT to participate in the meeting if needed.

Prior to the Pre-Construction Meeting, the Contractor should meet with all Utility Owners who will be required to perform utility relocations within the first 6 months of the project, to update the affected utilities of the Project Utility Coordination Form and all other applicable Contract requirements that impact the Utilities. The Contractor shall copy the Engineer on any correspondence between the Utility Owner and the Contractor.

**H. FORCE ACCOUNT / UTILITY MONITORING REQUIREMENTS**

The Engineer will be responsible for recording daily Utility work force reports. The start, suspension, re-start, and completion dates of each of the Utilities, within each phase of the utility relocation work, will be monitored and agreed to by the Engineer and the Contractor as the work progresses.

**I. ACCESS AND INSPECTION**

The Contractor shall be responsible for allowing Utility owners access to their own utilities to perform the relocations and/or inspections. The Contractor shall schedule their work accordingly so as not to delay or prevent each utility from maintaining their relocation schedule.



**SUBSECTION 8.02 SCHEDULE OF OPERATIONS**

Replace this subsection with the following:

An integrated cost and schedule controls program shall be implemented by the Contractor to track and document the progress of the Work from Notice to Proceed (NTP) through the Contractor Field Completion (CFC) Milestone. The Contractor's schedules will be used by the Engineer to monitor project progress, plan the level-of-effort required by the Department's work force and consultants and as a critical decision-making tool. Accordingly, the Contractor shall ensure that it complies fully with the requirements specified herein and that its schedules are both accurate and updated as required by the specification throughout the life of the project. Detailed requirements are provided in Division II, Section 722 Construction Scheduling.

---

## SECTION 722 CONSTRUCTION SCHEDULING

### DESCRIPTION

#### 722.20 General

The Contractor's approach to prosecution of the Work shall be disclosed to the Department by submission of a Critical Path Method (CPM) schedule and a cost/resource loaded Construction Schedule when required in this Subsection. These requirements are in addition to, and not in limitation of, requirements imposed in other sections.

The requirements for scheduling submissions are established based on the Project Value at the time of the bid and are designated as Type A, B, C or D. The definitions of these Schedule Requirement Types are summarized below. Complete descriptions of all detailed requirements are established elsewhere in this specification.

**Type A** – for all Site-Specific Contracts with a Project Value over \$20 Million

- Schedule Planning Session
- Baseline CPM Schedule
- Monthly Update CPM Schedule
- Short-term Construction Schedule
- Contract Schedule Update Meeting
- Resource-Loading
- Resources Graphic Reporting
- Cash Flow Projections from the CPM
- Cash Flow Charts
- Cost-loaded CPM
- Contractor-furnished CPM software, computer and training

**Type B** – for all Site-Specific Contracts with a Project Value between \$10 Million and \$20 Million

- Schedule Planning Session
- Baseline CPM Schedule
- Monthly Update CPM Schedule
- Short-term Construction Schedule
- Contract Schedule Update Meeting
- Cost-loaded CPM
- Resource-Loading
- Monthly Projected Spending Report (PSR)
- Contractor-furnished CPM software, computer and training

**SECTION 722** (Continued)

**Type C** – for all Site-Specific Contracts with a Project Value between \$3 Million and \$10 Million

- Schedule Planning Session
- Baseline CPM Schedule
- Monthly Update CPM Schedule
- Short-term Construction Schedule
- Contract Schedule Update Meeting
- Monthly Projected Spending Report (PSR)
- Contractor-furnished CPM software, computer and training

**Type D** - for all contracts with a Project Value less than \$3 Million; various locations contracts of any dollar amount; contracts with durations less than one-hundred and eighty (180) Calendar Days; and other contracts as determined by the Engineer.

- Bar chart schedule updated monthly or at the request of the Engineer (See Section 722.62.B - Bar Charts.)
- Monthly Projected Spending Report (PSR) (See Section 722.62.F - Projected Spending Reports.)

**MATERIALS, EQUIPMENT, PERSONNEL****722.40 General****A. Software Requirements** (Types A, B and C)

The Contractor shall use Primavera P6 computer scheduling software.

In addition to the requirements of Section 740 – Engineer’s Field Office and Equipment, the Contractor shall provide to the Department one (1) copy of the scheduling software, one (1) software license and one (1) computer capable of running the scheduling software for the duration of the Contract. This computer and software shall be installed in the Engineer’s Field Office within twenty-eight (28) Calendar Days after Notice to Proceed. The computer and software shall be maintained and serviced as recommended by the computer manufacturer and/or as required by the Engineer during the duration of the Contract at no additional cost to the Department. The Contractor shall provide professional training in the basic use of the software for up to eight (8) Department employees. The trainer shall be approved by the Engineer. This training shall be provided within twenty-eight (28) Calendar Days after Notice to Proceed.

**B. Scheduler Requirements**

For all schedule types, if the Contractor plans to use outside scheduling services, the scheduler shall be approved as a subcontractor by the Engineer.

For Type A, B and C Schedules the name of the Contractor’s Project Scheduler together with his/her qualifications shall be submitted to the Department for approval by the Engineer within seven (7) Calendar Days after NTP. The Project Scheduler shall have a minimum of five [5] years of project CPM scheduling experience, three [3] years of which shall be on projects of similar scope and value as the project for which the Project Scheduler is being proposed. References shall be provided from past projects that can attest to the capabilities of the Project Scheduler.

**SECTION 722** (Continued)**CONSTRUCTION METHODS****722.60 General****A. Schedule Planning Session**

(Types A, B and C)

The Contractor shall conduct a schedule planning session within seven (7) Calendar Days after the Contractor receives the NTP and prior to submission of the Baseline Schedule. This session will be attended by the Department and its consultants. During this session, the Contractor shall present its planned approach to the project including, but not limited to:

1. the Work to be performed by the Contractor and its subcontractors;
2. the planned construction sequence and phasing; planned crew sizes;
3. summary of equipment types, sizes, and numbers to be used for each work activity;
4. all early work related to third party utilities;
5. identification of the most critical submittals and projected submission timelines;
6. estimated durations of major work activities;
7. the anticipated Critical Path of the project and a summary of the activities on that Critical Path;
8. a summary of the most difficult schedule challenges the Contractor is anticipating and how it plans to manage and control those challenges;
9. a summary of the anticipated quarterly cash flow over the life of the project.

This will be an interactive session and the Contractor shall answer all questions that the Department and its consultants may have. The Contractor shall provide a minimum of five (5) copies of a written summary of the information presented and discussed during the session to the Engineer. The Contractor's Baseline Schedule and accompanying Schedule Narrative shall incorporate the information discussed at this Schedule Planning Session.

**B. Schedule Reviews by the Department (All Types)**

## 1. Baseline Schedule Reviews

The Engineer will respond to the Baseline Schedule Submission within thirty (30) Calendar Days of receipt providing comments, questions and/or disposition that either accepts the schedule or requires revision and resubmittal. Baseline Schedules shall be resubmitted within fifteen (15) Calendar Days after receipt of the Engineer's comments.

## 2. Contract Progress Schedule / Monthly Update Reviews

The Engineer will respond to each submittal within twenty one (21) Calendar Days. Schedules shall be resubmitted by the Contractor within five (5) Calendar Days after receipt of the Engineer's comments.

Failure to submit schedules as and when required could result in the withholding of full or partial pay estimate payments by the Engineer.

**SECTION 722** (Continued)**722.61 Schedule Content and Preparation Requirements**  
(Types A, B and C unless otherwise noted)

Each Contract Progress Schedule shall fully conform to these requirements.

**A. LOGIC**

The schedules shall divide the Work into activities with appropriate logic ties to show:

1. conformance with the requirements of this Section and Division I, Subsection 8.02 - Schedule of Operations
2. the Contractor's overall approach to the planning, scheduling and execution of the Work
3. conformance with any additional sequences of Work required by the Contract Documents, including, but not limited to, Subsection 8.03 - Prosecution of Work and Subsection 8.06 – Limitations of Operations.

**B. ACTIVITIES**

The schedules shall clearly define the progression of the Work from NTP to Contractor Field Completion (CFC) by using separate activities for each of the following items:

1. NTP
2. Each component of the Work defined by specific activities
3. Detailed activities to satisfy permit requirements
4. Procurement of fabricated materials and equipment with long lead times, including time for review and approval of submittals required before purchasing
5. The preparation and submission of shop drawings, procedures and other required submittals, with a planned duration that is to be demonstrated to the Engineer as reasonable
6. The review and return of shop drawings, procedures and other required submittals, approved or with comments, the duration of which shall be thirty (30) Calendar Days, unless otherwise specified or as approved by the Engineer
7. Interfaces with adjacent work, utility companies, other public agencies, sensitive abutters, and/or any other third party work affecting the Contract
8. The Critical Path, clearly defined and organized
9. Float shall be clearly identified
10. Access Restraints – restrictions on access to areas of the Work that are defined by the Department in the bid package, in Subsection 8.06 – Limitations of Operations or elsewhere in the Contract
11. Milestones listed in Subsection 8.03 - Prosecution of Work or elsewhere in the Contract Documents
12. Subcontractor approvals at fifteen (15) Calendar Days from submittal to response
13. Full Beneficial Use (FBU) Contract Milestone per the requirements of Subsection 8.03 - Prosecution of Work
14. Contractor's request for validation of FBU (ready to open to traffic)
15. The Department's confirmation of completed work to allow for FBU

**SECTION 722** (Continued)

16. Substantial Completion Contract Milestone per the requirements of Subsections 7.15 - Claims Against Contractors for Payment of Labor, Materials and Other Purposes and 8.03 - Prosecution of Work
17. Contractor's request for validation of Substantial Completion
18. Punchlist Completion Period of at least thirty (30) Calendar Days per the requirements of Subsections 5.11 - Final Acceptance, 7.15 - Claims Against Contractors for Payment of Labor, Materials and Other Purposes and 8.03 - Prosecution of Work
19. Contractor confirmation that all punchlist work and documentation has been completed
20. Physical Completion of the Work Contract Milestone per the requirements of Subsections 5.11 - Final Acceptance and 8.03 - Prosecution of Work
21. Documentation Completion per the requirements of Subsections 5.11 - Final Acceptance and 8.03 - Prosecution of Work
22. Contractor Field Completion Contract Milestone per the requirements of Subsections 5.11 - Final Acceptance and 8.03 - Prosecution of Work
23. Utility work to be performed in accordance with the Project Utility Coordination (PUC) Form as provided in Section 8.14 - Utilities Coordination, Documentation and Monitoring Responsibilities
24. Traffic work zone set-up and removal, night work and phasing
25. Early Utility Relocation (by others) that has been identified in the Contract
26. Right-of-Way (ROW) takings that have been identified in the Contract
27. Material Certifications
28. Work Breakdown Structure in accordance with the MassDOT-Highway Division Contractor Construction Schedule Toolkit located on the MassDOT-Highway Division website at:  
<https://www.mass.gov/info-details/massdot-highway-contractors-schedule-toolkit>
29. For Type A and B Contracts only: All items to be paid, including all Unit Price and Lump Sum pay items, shall be identified by activity. This shall include all non-construction activities such as engineering work; purchase of permanent materials and equipment, purchase of structural steel stock, equipment procurement, equipment delivery to the site or storage location and the representative amount of overhead/indirect costs that was included in the Contractor's Bid Prices.

**C. EARLY AND LATE DATES**

Early Dates shall be based on proceeding with the Work or a designated part of the Work exactly on the date when the corresponding Contract Time commences. Late Dates shall be based on completing the Work or a designated part of the Work exactly on the corresponding Contract Time, even if the Contractor anticipates early completion.

---

**SECTION 722** (Continued)**D. DURATIONS**

Activity durations shall be in Work Days. Planned Original Durations shall be established with consideration to resources and production rates that correspond to the Contractor's Bid Price. Within all of the Department-required schedules, the Contractor shall plan the Work using durations for all physical construction activities of no less than one (1) Work Day and no greater than fourteen (14) Work Days, unless approved by the Engineer as part of the Baseline Schedule Review.

Should there be an activity with a duration that is determined by the Engineer to be unreasonable, the Contractor will be asked to provide a basis of the duration using bid documents, historic production rates for similar work, or other form of validation that is acceptable to the Engineer. Should the Contractor and the Engineer be unable to agree on reasonable activity durations, the Engineer will, at a minimum, note the disagreement in the Baseline Schedule Review along with a duration the Engineer considers reasonable and the basis for that duration. A schedule that contains a substantial number of activities with durations that are deemed unreasonable by the Engineer will not be accepted.

**E. MATERIALS ON HAND (for Types A and B only)**

The Contractor shall identify in the Baseline Schedule all items of permanent materials (Materials On Hand) for which the Contractor intends to request payment prior to the incorporation of such items into the Work.

**F. ACTIVITY DESCRIPTIONS**

The Contractor shall use activity descriptions in all schedules that clearly describe the work to be performed using a combination of words, structure numbers, station numbers, bid item numbers, work breakdown structure (WBS) and/or elevations in a concise and compact label as specified in the MassDOT-Highway Division Contractor Construction Schedule Toolkit located on the MassDOT-Highway Division website at:

<https://www.mass.gov/info-details/massdot-highway-contractors-schedule-toolkit>

**G. ACTIVITY IDENTIFICATION NUMBERS**

The Contractor shall use the activity identification numbering system specified in the MassDOT-Highway Division Contractor Construction Schedule Toolkit located online at the address above.

**H. ACTIVITY CODES**

The Contractor shall use the activity codes specified in the MassDOT-Highway Division Contractor Construction Schedule Toolkit located online at the address above.

**I. CALENDARS**

Different calendars may be created and assigned to all activities or to individual activities. Calendars define the available hours of work in each Calendar Day, holidays and general or project-specific non-Work Days such as Fish Migration Periods, time of year (TOY) restrictions and/or area roadway restrictions.

**SECTION 722** (Continued)

Examples of special calendars include, but are not limited to:

- Winter Shutdown Period, specific work is required by separate special provision to be performed during the winter. See Special Provision 8.03 (if applicable)
- Peak traffic hours on heavily traveled roadways. This shall be from 6:30 am to 9:30 am and from 3:30 pm to 7:00 pm, unless specified differently elsewhere in the Contract.
- Special requirements by sensitive abutters, railroads, utilities and/or other state agencies as defined in the Contract.
- Cape Cod and the Islands Summer Roadway Work Restrictions: A general restriction against highway and bridge construction is enforced between Memorial Day and Labor Day, unless otherwise directed by the Engineer. Refer to the Project Special Provisions for specific restrictions.
- Cape Ann Summer Roadway Work Restrictions: While there are no general restrictions for Cape Ann as there are for Cape Cod and the Islands, project-specific restrictions may be enforced. Refer to the Project Special Provisions for specific restrictions.
- Turtle and/or Fish Migration Periods and/or other in-water work restrictions: Refer to the Project Special Provisions for specific restrictions.
- Working over Waterways Restricted Periods: Refer to the Project Special Provisions for specific restrictions.
- Night-time paving and striping operations, traffic and temperature restrictions: Refer to the Project Special Provisions for specific restrictions.
- Utility Restrictions shall be as specified within the Contract.

**J. FLOAT**

For the calculation of float in the CPM schedule, the setting for *Retained Logic* is required for all schedule submissions, starting with the Baseline Schedule Submission. Should the Contractor have a reason to propose that an alternative calculation setting such as *Progress Override* be used, the Contractor shall obtain the Engineer's approval prior to modifying to this setting.

**K. COST AND RESOURCE LOADING (Types A and B only)**

For all Type A and B Schedules, the Contractor shall provide a cost and resource-loaded schedule with an accurate allocation of the costs and resources necessary to complete the Work. The costs and resources shall be assigned to all schedule activities in order to enable the Contractor to efficiently execute the Contract requirements and the Engineer to validate the original plan, monitor progress, provide cash flow projections and analyze delays.

1. Each schedule activity shall have an assigned cost that accurately represents the value of the Work. Each schedule activity shall have its resources assigned to it by craft and the anticipated hours to accomplish the work. Each schedule activity's equipment resources shall be assigned to it by equipment type and hours operated. Front-loading or other unbalancing of the cost distribution will not be permitted.
2. The sum of the cost of all schedule activities shall be equal to the Contractor's Bid Price.
3. Indicating the labor hours per individual, per day, by craft and equipment hours/day will be acceptable.



**SECTION 722** (Continued)

4. The Engineer reserves the right to use the cost-loading as a means to resolve changes, disputes, time entitlement evaluations, increases or decreases in the scope of Work, unit price renegotiations and/or claims.
5. For all Type A and B Schedules, all subnets, fragnets, Proposal Schedules, and Recovery Schedules shall be cost and resource- loaded to help to quickly validate and monitor the duration of the Work to be performed.
6. For Type A Schedules, cost-loading of the schedule will also be used for cash flow projection purposes.
7. The cost-loading of each activity shall indicate the portion of the cost for that activity that is applicable to a specific bid item (cost account.) The total cost for each cost account must equal the bid item price.
8. For Type A Schedules, each month, the Contractor will be paid using the Cost-loaded CPM activities for Lump Sum payment items. This requirement supersedes any requirements elsewhere in this Contract regarding partial payments of schedule-of-values for all Lump Sum items.

**L. NOT TO BE USED IN THE CONTRACTOR'S CPM SCHEDULE**

1. Milestones or constraint dates not specified in the Contract
2. Scheduled work not required for the accomplishment of a Contract Milestone
3. Use of activity durations, logic ties and/or sequences deemed unreasonable by the Engineer
4. Delayed starts of follow-on trades
5. Float suppression techniques

**722.62 Submittal Requirements**

All schedules shall be prepared and submitted in accordance with the requirements listed below.

Each monthly Contract Progress Schedule submittal shall be uniquely identified.

Except as stated elsewhere in this subsection, schedule submittals shall include each of the documents listed below, prepared in two formats, for distribution as follows:

- a. four (4) compact discs (CD); one (1) each for the Office of Project Controls and Performance Oversight (O-PC&PO), the Boston Construction Section Office, the District Construction Office and the Resident Engineer's Office. Additional copies shall be required if the work is performed in more than one district.
- b. two (2) hard copies plotted in color on 24" X 36" paper; one (1) copy each for the District Construction Office and the Resident Engineer's Office. No copies for the O-PC&PO and the Boston Construction Section Office. Additional copies shall be required if the work is performed in more than one district.

**SECTION 722** (Continued)**A. Narratives**

A written narrative shall be submitted with every schedule submittal. The narrative shall:

1. itemize and describe the flow of work for all activities on the Critical Path in a format that includes any changes made to the schedule since the previous Contract Progress Schedule / Monthly Update or the Baseline Schedule, whichever is most recent;
2. provide a description of any specification requirements that are not being followed. Identify those that are improvements and those that are not considered to be meeting the requirements;
3. provide all references to any Notice of Delay that has been issued, within the time period of the Contract Progress Schedule Update, by letter to the Engineer. Note that any Notice of Delay that is not issued by letter will not be recognized by the Engineer. See Subsection 722.64.A - Notice of Delay;
4. provide a description of each third-party utility's planned vs. actual progress and note any that are trending late or are late per the durations and commitments as provided in the PUC Form; provide a description of the five (5) most important responses needed from the Department and the need date for the responses in order to maintain the current Schedule of Record;
5. provide a description of all critical issues that are not within the control of the Contractor or the Department (third party) and any impact they had or may have on the Critical Path;
6. provide a description of any possible considerations to improve the probability of completing the project early or on-time;
7. compare Early and Late Dates for activities on the Critical Path and describe reasons for changes in the top three (3) most critical paths ;
8. describe the Contractor's plan, approach, methodologies and resources to be employed for completing the various operations and elements of the Work for the top three (3) most critical paths. For update schedules, describe and propose changes to those plans and verify that a Proposal Schedule is not required;
9. describe, in general, the need for shifts that are not 5 days/week, 8 hours/day, the holidays that are inserted into each calendar and a tabulation of each calendar that has been used in the schedule;
10. describe any out-of-sequence logic and provide an explanation of why each out-of-sequence activity does not require a correction, if one has not been provided, and an adequate demonstration that these changes represent the basis of how these activities will be built, including considerations for resources, dependencies and previously-approved production rates;
11. identify any possible duration increases resulting from actual or anticipated unit price item quantity overruns as compared to the baseline duration, with a corresponding suggestion to mitigate any possible delays to the Critical Path. If the delay is anticipated to impact the Critical Path, refer to Subsections 4.06 - Increased or Decreased Contract Quantities and 8.10 - Determination and Extension of Contract Time for Completion and submit a letter to the Engineer notifying of a potential delay;
12. include a schedule log consisting of the name of the schedule, the data date and the date submitted.

---

**SECTION 722** (Continued)**B. Bar Charts (Types A, B, C and D)**

One (1) time-scaled bar chart containing all activities shall be prepared and submitted using a scale that yields readable plots and that meets the requirements of Subsection 722.61 - Schedule Content and Preparation Requirements. Activities shall be linked by logic ties and shown on their Early Dates. Critical Paths shall be highlighted and Total Float shall be shown for all activities.

A second time-scaled bar chart shall also be prepared containing only the Critical Path or, if the Critical Path is not the longest path, the Longest Path using a scale that yields readable plots and that meets the requirements of Subsection 722.61 - Schedule Content and Preparation Requirements. Activities shall be linked by logic ties and shown on their Early Dates. Total Float shall be shown for all activities.

Bar Charts shall be printed in color and submitted on 11" X 17" paper or, if approved by the Engineer, as a .pdf file.

**C. Detailed Activity Schedule Comparisons**

A Detailed Activity Schedule Comparison (DASC) is a simple reporting tool in the format of a graphical report that will provide Resident Engineers with immediate, timely and up-to-date information. The DASC consists of an updated bar chart that overlays the current time period's bar chart onto the previous time period's bar chart for an easily-read comparison of progress during the present and previous reporting periods. The DASC shall be prepared and submitted in accordance with the instructions contained in the Construction Schedule Toolkit located on the MassDOT-Highway Division website at:

<https://www.mass.gov/info-details/massdot-highway-contractors-schedule-toolkit>

The reports described in Subsections D, E and F below shall be submitted with all of the schedules listed in Subsection 722.20 - General:

**D. Activity Cost Report and Monthly Cash Flow Projections (Type A only)**

With each Contractor Quantity Estimate (CQE), the Contractor shall submit an Activity Cost Report and Cash Flow Projection that includes all activities grouped by Contract Bid Item.

The Activity Cost Report shall be generated from the Schedule of Record and shall be the basis of the Monthly Cash Flow Projection. Within each contract Bid Item, activities shall be sequenced by ascending activity identification number and shall show:

1. activity ID and description,
2. forecast start and finish dates for each activity and,
3. when submitted as a revised schedule, actual start and finish dates for each completed activity.

For Unit Price pay items, in addition to the above, estimates to complete and any variance to the estimated Contract quantity shall be shown.

**E. Resource Graphs (Type A only)**

Monthly and cumulative resource graphs for the remaining Contract period using the Early Dates and Late Dates in the Contract Progress Schedule shall be included as part of each schedule submittal.

---

**SECTION 722** (Continued)**F. Projected Spending Reports (Types B, C and D)**

A Projected Spending Report (PSR) shall be prepared and submitted in accordance with the instructions listed at the end of this section. The PSR shall indicate the monthly spending (cash flow) projection for each month from NTP to Contractor Field Completion (CFC). Each month's actual spending shall be calculated using all CQEs paid during that month. If the difference between the Contractor's monthly projections vs. the actual spending is greater than 10%, the Contractor's monthly spending projection shall be revised and resubmitted within fifteen (15) Calendar Days.

The Projected Spending Report (PSR) shall be depicted in a tabular format and printed in color on 11 x 17-sized paper or larger as approved by the Engineer. For additional instructions and a template for preparing the Projected Spending Report (PSR), refer to the Contractor's Construction Schedule Toolkit located on the MassDOT-Highway Division website at:

<https://www.mass.gov/info-details/massdot-highway-contractors-schedule-toolkit> or consult with the District Construction Scheduler.

**722.63. Progress Schedule Requirements****A. Baseline Schedule**

The Baseline Schedule shall be due thirty (30) Calendar Days after Notice to Proceed (NTP.) The Baseline Schedule shall only reflect the Work awarded to the Contractor and shall not include any additional work involving Extra Work Orders or any other type of alleged delay. The Baseline Schedule shall be prepared and submitted in accordance with Subsections 722.61 - Schedule Content and Preparation Requirements and 722.62 - Submittal Requirements. Once the Baseline Schedule has been accepted by the Engineer, with or without comments, it shall represent the as-planned schedule for the Work and become the Contract Progress Schedule of Record until such time as the schedule is updated or revised under Subsections 722.63.C - Contract Progress Schedules / Monthly Updates, 722.64.C - Recovery Schedules and 722.64.D - Proposal Schedules.

The Cost and Resource-Loading information (Types A and B only) shall be provided by the Contractor within forty-five (45) Calendar Days after NTP.

The Engineer's review comments on the Baseline Schedule and the Contractor's responses to them will be maintained for the duration of the Contract and will be used by the Engineer to monitor the Contractor's work progress by comparing it to the Contract Progress Schedule / Monthly Update.

**B. Interim Progress-Only Schedule Submissions**

The first monthly update of the Contract Progress Schedule/Monthly Update is due within seventy (70) Calendar Days after Notice to Proceed (NTP.) The Baseline Schedule review period ends at sixty (60) Calendar Days after NTP, see Subsection 722.60.B - Schedule Reviews by the Department. If the Baseline Schedule has not been accepted within sixty (60) Calendar Days after NTP, an Interim Progress-Only Schedule shall be due within seventy (70) Calendar Days after NTP. The purpose of the Interim Progress-Only Schedule is to document the actual progress of all activities, including non-construction activities, from NTP until the Baseline Schedule is accepted.

**SECTION 722** (Continued)**C. Contract Progress Schedules / Monthly Updates** (Types A, B, C and D)

The first Contract Progress Schedule shall be submitted by the Contractor no later than seventy (70) Calendar Days after NTP. The data date for this first Progress Schedule shall be sixty (60) Calendar Days after NTP. Subsequent Progress Schedules shall be submitted monthly.

Each Contract Progress Schedule shall reflect progress up to the data date. Updated progress shall be limited to as-built sequencing and as-built dates for completed and in-progress activities. As-built data shall include actual start dates, remaining Work Days and actual finish dates for each activity, but shall not change any activity descriptions, the Original Durations, or the Original Resources (as planned at the time of bid), without the acceptance of the Engineer. If any activities have been completed out-of-sequence, the Contractor shall propose new logic ties for affected in-progress and future activities that accurately reflect the previously-approved sequencing. Alternatively, the Contractor may submit to the Engineer for approval an explanation of why an out-of-sequence activity does not require a correction and an adequate demonstration that the changes accurately represent how the activities will be built, including considerations for resources, dependencies and previously approved production rates. Once approved by the Engineer, the Contractor may incorporate the changes in the next Contract Progress Schedule/Monthly Update with the affected activities clearly identified and explained in the Schedule Narrative.

No revisions to logic ties; sequence, description or duration of future activities; or planned resource costs shall be made without prior approval by the Engineer.

Any proposed logic changes for in-progress or future activities shall be submitted to the Engineer for approval before being incorporated into a Contract Progress Schedule. The logic changes must be submitted using a Proposal Schedule or a schedule fragment submission. Once approved by the Engineer, the Contractor may incorporate the logic in the next Contract Progress Schedule/Monthly Update with the affected activities clearly identified and explained in the Schedule Narrative.

For any proposed changes to the original sequence, description or duration of future activities, the Contractor shall submit to the Engineer for approval an explanation of how the proposed description or duration change reflects how the activity will be progressed, including considerations for resources and previously approved production rates. Any description or duration change that does not accurately reflect how the activity will be progressed will not be approved by the Engineer. Once approved by the Engineer, the Contractor may incorporate the changes in the next Contract Progress Schedule/Monthly Update with the affected activities clearly identified and explained in the Schedule Narrative.

Except as otherwise designated by a Contract Modification, no Contract Progress Schedule that extends performance beyond the Contract Time and/or beyond any Contract Milestone shall be approved by the Engineer. The Contractor shall submit a Recovery Schedule if any Contract Progress Schedule/Monthly Update indicates a failure to meet the Contract Dates.

**D. Short-Term Construction Schedule**

The Contractor shall provide a Short-Term Construction Schedule that details daily work activities, including any multiple shift work that the Contractor intends to conduct, in a bar chart format. The daily activities shall directly correspond to the Contract Progress Schedule activities, with a matching reference to the activity identification number in the Contract Progress Schedule, and may be at a greater level of detail.

**SECTION 722** (Continued)

The Short-Term Construction Schedule shall be submitted every two weeks. It shall display all work for a thirty-five (35) Calendar Day period consisting of completed work for the two (2) week period prior and all planned work for the following three (3) week period. The initial submission shall be provided no later than thirty (30) Calendar Days after NTP or as required by the Engineer.

The Contractor shall be prepared to discuss the Short-Term Construction Schedule, in detail, with the Engineer in order to coordinate field inspection staff requirements, the schedule of work affecting abutters and any corresponding work with affected utilities. Short-Term Construction Schedules shall be prepared and submitted in accordance with Subsections 722.61 - Schedule Content and Preparation Requirements and 722.62 - Submittal Requirements.

Failure to submit Short-Term Construction Schedules every two (2) weeks may result in withholding of full or partial payments by the Engineer.

**722.64 Impacted Schedule Requirements****A. Notice of Delay**

The Contractor shall notify the Engineer in writing, with copies to the District and State Construction Engineers, within three (3) Calendar Days of the start of any delays to the Critical Path that are caused by actions or inactions that were not within the control of the Contractor. Delay notifications that are not provided in a letter to the Engineer, such as a delay notification in the schedule narrative, will not be recognized as contractual notice in the determination of any Time Extension related to the impacts to the work associated with this specific alleged delay. Should such delay continue for more than one (1) week, the Contractor shall note it in the Schedule Narrative until the delay is no longer impacting the Critical Path for the completion of the Contract Milestones. The Engineer will evaluate the alleged delay and its impact and will respond to the Contractor within ten (10) Calendar Days after receipt of a notice of delay.

**B. Time Entitlement Analysis**

A Time Entitlement Analysis (TEA) shall consist of a descriptive narrative, prepared in accordance with Subsection 722.62.A - Narratives, and an as-built CPM schedule, which may be in the form of a schedule fragnet ( that has been developed from the project's Contract Progress Schedule of Record, and illustrates the impact of a delay to the Critical Path, Contract Milestones and/or Contract Completion Date as required in Subsection 8.10 - Determination and Extension of Contract Time for Completion. TEAs shall also be used to determine the schedule impact of proposed Extra Work Orders (EWO) as also required in Subsection 8.10.

TEAs shall be prepared and submitted in accordance with the requirements of Subsections 722.61 - Schedule Content and Preparation Requirements and 722.62 - Submittal Requirements and shall be based on the Contract Progress Schedule of Record applicable at the start of the delay or impact from an EWO. A TEA fragnet must start with a specific new activity describing the work contained in either a Notice of Delay previously submitted to the Department per Subsection 722.64.A - Notice of Delay or an EWO.

**SECTION 722** (Continued)

TEAs shall be submitted:

1. as part of any Extra Work Order that may impact Contract Time,
2. with a request for a Time Extension,
3. within fourteen (14) Calendar Days after a request for a TEA by the Engineer for any other reason.

A TEA shall be submitted to the Engineer before any Time Extension is granted to the Contractor. Time Extensions will not be granted unless the TEA accurately reflects an evaluation of all past delays and the actual events that occurred that impacted the Critical Path. The TEA must also demonstrate a plan for the efficient completion of all of the remaining work through an optimized CPM Schedule. The analysis shall include all delays, including Contractor-caused delays, and shall be subdivided into timeframes and causes of delays.

TEAs shall incorporate any proposed activities, logic ties, resource considerations, and activity costs required to most efficiently demonstrate the schedule impacts in addition to detailing all impacts to existing activities, logic ties, the Critical Path, Contract Milestones and the Contract Completion Date. In addition, TEAs shall accurately reflect any changes made to activities, logic ties, restraints and activity costs, necessitated by an Extra Work Order or other schedule impact, for the completion of the remaining work. The Contractor shall provide TEAs that demonstrate that all delays have been mitigated to the fullest extent possible without requiring an Equitable Adjustment to the original bid basis.

All TEAs shall clearly indicate any overtime hours, additional shifts and the resource that are proposed to be incorporated in the schedule. The Engineer shall have final discretion over the use of overtime hours and additional shifts. The Engineer shall have the right to require that overtime hours and/or additional shifts be used to minimize the duration of Time Extensions if it is determined to be in the best interest of the Department to do so.

When accepted, the changes included in a TEA shall be incorporated into the next Contract Progress Schedule per the requirements of Subsection 722.63.C - Contract Progress Schedules / Monthly Updates.

During the review of any TEA, all Contract Progress Schedules shall continue to be submitted as required.

The Engineer may request that the Contractor prepare a Proposal Schedule or a Recovery Schedule to further mitigate any delays that are shown in the accepted TEA/Contract Progress Schedule.

**C. Recovery Schedules**

The Contractor shall promptly report to the Engineer all schedule delays during the prosecution of the Work. Except as otherwise designated by a Contract Modification, no Contract Progress Schedule that extends performance beyond the Contract Time and/or beyond any Contract Milestone shall be approved by the Engineer. The Contractor shall submit a Recovery Schedule within fourteen (14) Calendar Days of a Contract Progress Schedule submission that shows failure to meet the Contract Dates. This requirement is critical to the Department's ability to make informed decisions regarding Contract Time and costs.

**SECTION 722** (Continued)

During the prosecution of the Work, should the Contractor's progress on a critical operation clearly not meet anticipated production, without cause by fault of the Department, or should a critical activity or series of activities not be staffed in accordance with the Contractor's approved Baseline Schedule resource planning, the Contractor shall be obligated to recover such delay. Recovery Schedules shall be prepared and submitted in accordance with Subsections 722.61 - Schedule Content and Preparation Requirements and 722.62 - Submittal Requirements within fourteen (14) Calendar Days of any of the cases listed above.

Recovery Schedules shall clearly indicate any proposed overtime hours, additional shifts, and the resources that are proposed to be incorporated in to the schedule. The Engineer shall have final discretion over the use of overtime hours and additional shifts and shall have the right to require that overtime hours and/or additional shifts be used to minimize the duration of Time Extensions, without additional compensation for any Contractor delays, if it is determined to be in the best interest of the Department to do so.

During the review of any Recovery Schedule, all Contract Progress Schedules shall continue to be required every month.

The Engineer may request that the Contractor prepare a Recovery Schedule to further mitigate any delays that are shown in an accepted TEA/Contract Progress Schedule.

Changes represented in accepted Recovery Schedules shall be incorporated into the next Contract Progress Schedule.

**D. Proposal Schedules**

A Proposal Schedule is an alternative schedule used to evaluate proposed changes to the Contract scope or significant alternatives to previously approved approaches to complete the Work, which may include changes to activity durations, logic and sequence. For Types A and B Schedules, the Proposal Schedule shall be cost and resource-loaded.

A Proposal Schedule may be requested by the Department at any time or may be offered by the Contractor. The Engineer may request that the Contractor prepare a Proposal Schedule to further mitigate any delays that are shown in an accepted TEA/Contract Progress Schedule.

The Contractor shall submit the Proposal Schedule within thirty (30) Calendar Days of a request from the Department.

The Proposal Schedule shall not be considered a Schedule of Record until the logic, durations, narrative and basis of the Proposal Schedule have been accepted by the Engineer. If the Proposal Schedule took the form of a fragnet, it must be incorporated into the Contract Progress Schedule of Record showing the current progress of all other activities and the impacts/results of the changes made by the Proposal Schedule before the Proposal Schedule is accepted by the Department.

Proposal Schedules shall clearly indicate any proposed overtime hours, additional shifts, and the resources that are proposed to be incorporated in the schedule. The Engineer shall have final discretion over the use of overtime hours and additional shifts.

Changes represented in accepted Proposal Schedules shall be incorporated into the next Contract Progress Schedule. During the review of any Proposal Schedule, all Contract Progress Schedules shall continue to be required every month.



**SECTION 722** (Continued)**E. Disputes (Types A, B, C and D)**

All schedules shall be submitted, reviewed, dispositioned and accepted in the timely manner specified herein so as to provide the greatest possible benefit to the execution of this Contract.

Any dispute concerning the acceptance of a schedule or any other question of fact arising under this subsection shall be determined by the Engineer. Pending resolution of any dispute, the last schedule accepted by the Engineer will remain the Contract Schedule of Record.

**COMPENSATION****722.80 Method of Measurement and Basis of Payment (Types A, B, C and D)**

The Special Provisions will specify the fixed-price amount to be paid to the Contractor for the Project Schedule requirements contained herein. Each bidder shall include this lump-sum, fixed-price bid item amount in his/her bid. Failure to do so may be grounds for the rejection of the bid.

All required schedule-related work, including, but not limited to computers, computer software, the planning and coordination with utilities, training, schedule preparation and schedule submittals will be paid for under the fixed price amount.

This fixed price amount is for payment purposes only and is separate from what the Department considers to be the Contractor's General Condition costs. If the Contractor deems it necessary to include additional costs to provide all of the requirements of this section, these additional costs shall be included in the Contractor's overall bid price.

Twenty percent (20%) of this pay item will be paid upon the Engineer's acceptance of the Contractor's Baseline Schedule, prepared and submitted in accordance with Subsection 722.63.A.

The remaining eighty percent (80%) of this pay item will be paid in equal monthly installments distributed across the Contract Duration from Notice to Proceed (NTP) to Contractor Field Completion (CFC), less the 2 months required for the submittal and review of the Baseline Schedule in accordance with the following formula:

$$\text{Monthly Payment} = \frac{\text{Remaining Fixed Price amount (80\% of Item 100.)}}{\text{Contract Duration in whole months} - 2 \text{ months}}$$

The timely and accurate submission of the Baseline Schedule is critical to the Contract and the Department's ability to make informed decisions. Only payments under Item 740 - Engineer's Field Office and Item 748 - Mobilization will be made until the Baseline Schedule is accepted by the Engineer.

**SECTION 722** (Continued)

No payment for any other pay item will be processed beyond seventy-five (75) Calendar Days from Notice to Proceed (NTP) until the Baseline Schedule is accepted by the Engineer. Until the Engineer's acceptance of the Baseline Schedule, the combined total of all payments made to the Contractor will be limited to an amount no greater than the total price for Item 748 - Mobilization or 3% of the contract price, whichever is less.

All Contract Progress Schedule Updates submitted later than ten (10) Calendar Days after the CQE (Contract Quantity Estimate) completion date, or greater than forty (40) Calendar Days from the Data Date of the previous submission, will be deemed to be no longer useful and will not qualify for payment. Late submittal of missed Contract Progress Monthly Updates will not result in recovery of the previously forfeited portion of the Schedule of Operations Fixed Price Payment Item.

Failure to submit schedules as and when required may result in the forfeiture of that portion of the Schedule of Operations Fixed Price Payment and/or the withholding of the full or partial CQE payments by the Engineer.

Failure to submit schedules that are acceptable to the Engineer may result in the forfeiture of that portion of the Schedule of Operations Fixed Price Payment and/or the withholding of the full or partial CQE payments by the Engineer.

The Schedule of Operations pay item will be adjusted to pay for only the actual quantity of schedules that have been submitted in accordance with this section.

The Contractor's failure or refusal to comply with the requirements of this Section shall be reasonable evidence that the Contractor is not prosecuting the Work with due diligence and may result in the withholding of full or partial payments by the Engineer.

Should there be a Time Extension granted to the Contractor, the Engineer may provide an Equitable Adjustment for additional Contract Progress Schedule Updates at intervals directed by the Engineer. Item 100. will be the basis for this Equitable Adjustment.

**722.82          Payment Items**

100.                  SCHEDULE OF OPERATIONS - FIXED PRICE \_\_\_\_\_ LUMP SUM

**ITEM 100.95****GEOTECHNICAL MONITORING  
AND INSTRUMENTATION****LUMP SUM**

The work under this Item shall include, but not be limited to, all materials, equipment, labor, and services required to install, protect, replace, monitor, and report on geotechnical instrumentation specified herein.

The work under this Item includes the following:

1. Pre-construction site walk with the Engineer at least two weeks prior to the start of construction to determine locations of ground, surface, and utility monitoring points.
2. Preparation and implementation of a geotechnical monitoring and instrumentation plan with the following requirements:
  - a. Pre-construction and post-construction visual examination of adjacent structures which shall include photographs or videos. Adjacent structures to be examined include but are not limited to the following:
    - i. Car Keys, 1098 Main Street, Fitchburg, MA 01420
    - ii. Dunkin Donuts, 33-37 River Street, Fitchburg, MA 01420
    - iii. Crocker Field, Fitchburg, MA
    - iv. Existing 12-inch diameter sewer under North Nashua River
  - b. Vibration monitoring shall be performed continuously during all excavation, backfill, compaction, installation of driven piles and installation of temporary support of excavation. Two seismographs shall monitor vibrations at two separate locations per crew; one adjacent to the work and one adjacent to the nearest vibration sensitive private property. Vibration levels at the vibration sensitive private properties shall not exceed the criteria indicated herein.
  - c. Furnish, install, protect, replace, monitor, and report on ground surface and building deformation monitoring points. The Engineer will assist the Contractor in determining the final locations.
  - d. At locations where structure and/or monitoring points are required on private property, the Contractor shall obtain a right of entry to obtain access. A Right of Entry form shall be obtained from the property owner prior to conducting an internal building inspection.
  - e. The Contractor shall retain the services of Geotechnical Monitoring Consultant and Surveyor to install, monitor, maintain and report on geotechnical instrumentation that includes but is not limited to ground surface, building deformation monitoring points, Utility Monitoring Points, crack gauges and vibrations.
  - f. Replace instrumentation damaged or made inaccessible by the construction operations at no additional cost to the Department.

---

**ITEM 100.95** (Continued)**MATERIALS****Deformation Monitoring Points**

Deformation monitoring points which include Building or Structure Monitoring Points (SMPs), and Ground Surface Monitoring Points (GMPs) shall consist of 3-inch long surveyors' "PK" nails, securely nailed in place, a #4 rebar 12 inches long driven flush into the ground surface or ½-inch diameter carriage bolts drilled 2 inches into the building surface and extending approximately 3 inches from the building face. Surface monitoring points may also consist of an observable point punch marked on the top horizontal surface of a manhole or catch basin rim. The steel surface within 3 inches of the point shall be cleaned by wire brush to permit easy identification of the exact point. The point shall be clearly identified using fluorescent spray paint adjacent to the point.

**Vibration Monitoring**

Construction vibrations shall be monitored as described in the Contract Specifications in terms of peak particle velocity using a seismograph with continuous recording capability. Capability to record vibrations at two locations simultaneously is required. The vibration sensors shall be capable of recording three orthogonal components of vibration.

**Utility Monitoring Points**

1. Provide 2-inch PVC casing, threaded and coupled, as needed.
2. Provide No. 4 rebar, threaded and coupled, as needed.
3. Installation borehole shall be backfilled with cement-bentonite grout.

**Crack Gauges**

Provide a calibrated direct read building crack monitor consisting of overlapping glass or acrylic plates. The crack monitor shall be waterproof and weather resistant and shall be capable of being read to a resolution of 0.02-inch with a maximum horizontal range of at least 0.75-inch and a vertical range of at least 0.375-inch, and shall be bolted or epoxied to the surface.

For uneven surfaces, such as stone, pairs of flat washers should be used, with the distance between the washers measured with a caliper.

**ITEM 100.95** (Continued)**CONSTRUCTION METHODS****Submittals**

The Contractor shall submit the following:

1. Qualifications of the Geotechnical Monitoring Consultant and Surveyor submitted at least three weeks prior to construction.
2. Geotechnical Monitoring Plan. Submit Plan at least three weeks prior to any work that could cause vibrations. No vibration-causing activities may occur until the Plan has been accepted by the Engineer and the accepted instrumentation is in place. Plan shall contain, at a minimum:
  - a. Drawings that indicate the instrumentation locations, sizes, and material types.
  - b. Manufacturers' data and specifications, installation procedures, and other data. Provide description of work and materials.
  - c. A mitigation plan that shall detail the Contractor's course of action in the event threshold or limiting response values are met or exceeded. Such mitigation plan shall be revised as appropriate for each instance threshold and/or limiting values are reached.
3. The Geotechnical Monitoring Consultant shall submit initial baseline survey data on a plan indicating locations and elevations of all instrumentation monitoring points to the Engineer at least three days prior to beginning of the installation of the temporary support of excavation, excavation operations or driven pile operations.

The Geotechnical Monitoring Consultant and Surveyor shall submit subsequent survey data on all instrumentation monitoring points to the Engineer prior to the beginning of work the following day. A faster turnaround of data reporting may be required by the Engineer if threshold or limiting response values, as specified in this Section, are approached or exceeded. Data shall be tabulated and depicted graphically on plots and show incremental and cumulative movement since the start of excavation or driven pile operations.

**Quality Control**

1. The Contractor shall provide sufficient notice to the Engineer to allow the Engineer to be present to observe the Work. Cooperate with the Engineer in all respects to facilitate any testing or observations.
2. The Contractor may conduct additional testing or monitoring for its own information, at no additional cost to the Department.

**ITEM 100.95** (Continued)

3. The presence of the Engineer (including observations and review of test results) shall not relieve the Contractor of their sole responsibility to perform the work in accordance with the Contract Documents, nor shall they be construed to relieve the Contractor from full responsibility for the means and methods of construction and for safety on the construction site.
4. Work not in conformance with the specified requirements shall be improved, or removed and replaced, at no additional cost to the Department. All costs related to testing of nonconforming Work or materials shall be paid for by the Contractor, at no additional cost to the Department.
5. Measure and report all data on movements of all instrumentation monitoring points to the nearest 0.01 ft.
6. Retain the services of a Geotechnical Monitoring Consultant to monitor the geotechnical instrumentation specified herein, which includes and is not limited to vibration monitoring.
  - a. The Geotechnical Monitoring Consultant shall be a Geotechnical Engineer registered in the Commonwealth of Massachusetts and shall have demonstrated at least five years' experience and at least three projects of similar type, size, and complexity including installation and monitoring of vibrations with seismographs.
  - b. The Geotechnical Monitoring Consultant shall be approved by the Engineer and must be approved two weeks prior to mobilization for construction.
  - c. The Geotechnical Monitoring Consultant shall adhere to all methods and standards described in this Specification.
7. Retain the services of a Surveyor to monitor the geotechnical instrumentation specified herein which includes and is not limited to building, structure, utility, ground, and excavation support system monitoring points.
  - a. The Contractor's Surveyor shall be registered in the Commonwealth of Massachusetts and shall have demonstrated at least five years' experience and at least three projects of similar type, size, and complexity including installation and monitoring of surface vertical and horizontal displacement points.
  - b. The Contractor's Surveyor shall be approved by the Engineer and must be approved two weeks prior to construction.
  - c. The Contractor's Surveyor shall adhere to all methods and standards described in this Specification.

**ITEM 100.95** (Continued)**Execution****A. General**

Do not install any instruments until the Engineer has been properly notified.

**B. Pre-Construction Site Walk**

The Contractor, Engineer, and Geotechnical Monitoring Consultant shall perform a detailed visual examination of the Site and surrounding properties and document by photograph or video the condition of on- and off-site buildings and improvements, including but not limited to:

1. Exterior facades
2. Locations of cracks, missing plaster, and damaged masonry
3. Damaged roofing
4. Walls or other features that are not vertical or out of plumb
5. Damaged foundations
6. Other damage that could be misconstrued as damage caused by the Contractor.

The Contractor shall prepare a Geotechnical Monitoring Plan as described above based on the findings of the pre-construction site walk.

**C. Installation****Building or Structure Monitoring (SMPs)**

1. SMPs shall be installed at the locations and depths as determined by the Geotechnical Monitoring Consultant during site walks prior to construction.
2. All SMPs shall have the horizontal as-built location determined to an accuracy of 0.5-feet and the elevation to an accuracy of 0.01-feet.

**Utility Monitoring Points (UMPs)**

1. UMPs shall be installed at the locations and depths as determined by the Geotechnical Monitoring Consultant during site walks prior to construction and as required by the utility owner.
2. Where required, the Contractor shall install the UMPs by the use of vacuum excavation exercising due diligence not to disturb or damage the utility being monitored and to minimize disruption and damage to adjacent areas.
3. The location of the utility in plan shall be determined and the borehole advanced to within a maximum of 2-feet above the utility. The Contractor shall be responsible for any damage to the utility during installation of the utility monitoring points. Drill casing may be used during the installation.
4. After completion of installation, the as-built location in horizontal position shall be determined to an accuracy of 1-foot and in elevation to an accuracy of 0.01-feet.

**ITEM 100.95** (Continued)Ground Surface Monitoring Points (GMPs)

1. GMPs shall be installed at the locations and depths as determined by the Geotechnical Monitoring Consultant during site walks prior to construction.
2. All GMPs shall have the horizontal as-built location determined to an accuracy of 0.5-feet and the elevation to an accuracy of 0.01-feet.

Seismographs

1. One seismograph shall be installed within 25 feet of the work zone in the direction of the nearest structure located outside of the work zone. The second seismograph shall be installed adjacent to the existing above grade structure nearest to the work. If there are no existing structures within 50 feet, the second seismograph shall be installed on a firm surface, 50 to 75 feet from the work zone in the direction of the nearest structure located outside of the work zone. Vibration sensors shall be firmly mounted on the surface of concrete or asphalt, or firmly on undisturbed soil.
2. The daily report shall clearly describe the location of the seismograph relative to the work zone and the work performed on that date.

Crack Gauges

1. Locations of existing building cracks shall be identified prior to construction. For bidding purposes, the Contractor shall assume a minimum of 15 existing and new cracks will need to be monitored as part of the work of this Section.

**D. Monitoring**

Monitoring frequency may be increased as required by the Engineer for some or all of the monitoring points if the threshold or limiting response values are approached or exceeded during the Work, at no additional cost to the Department.

1. Seismographs shall be set up to monitor vibrations continuously during all excavation, backfill, compaction, driven pile operations and installation of temporary earth support. Two seismographs shall monitor vibrations at locations as described in Section C. Installation, Seismographs. Vibration levels shall not exceed the criteria indicated herein.
2. Ground surface, building deformation monitoring points, Utility Monitoring Points, and crack gauges shall be monitored twice a week for all points located within 100 feet from the edge of the excavation, during all excavation, backfill, compaction, driven pile operations and installation of temporary earth support unless otherwise required by the Engineer or specified.

After each set of readings is obtained, the data shall be sent to the Engineer, where the data will be reviewed and interpreted. The Contractor shall make its own interpretations of the data. The Contractor shall monitor and interpret data from additional instrumentation that is required to ensure the safety of its work. The Engineer is not responsible for the safety of the work based on its review of the instrumentation data.



**ITEM 100.95** (Continued)**E. Reporting Data**

1. A plan showing location and numbering system for monitoring points shall be submitted to the Engineer prior to start of excavation or other vibration-causing activities, along with results of two initial baseline surveys.
2. Tables of results of surveys shall be submitted prior to the beginning of work the following day. The table of survey results shall include the initial measurement, the current measurement, and the amount of movement since start of excavation.
3. Survey data shall be depicted graphically on plots and submitted with the tabular results to show incremental and cumulative movement since the start of excavation.
4. Criteria for "threshold" and "limiting" vibration acceptance measured from seismographs during demolition, construction of temporary excavation support, excavation and backfilling, and driving of piles shall be as follows:
  - a. "Threshold" values in peak particle velocity (inches per second): for wood, steel and brick buildings shall be 0.6, and for historical stone structures 0.3 as measured from the ground surface within the limits of the work zone or adjacent areas where vibrations are monitored.
  - b. "Limiting" values in peak particle velocity (inches per second): for wood, steel and brick buildings shall be 0.8, and for historical stone structures 0.5 as measured from the ground surface within the limits of the work zone or at other adjacent areas where vibrations are monitored.
5. Criteria for "threshold" and "limiting" settlement of GMP's located on the sidewalk or paved roadway areas adjacent to the temporary lateral support systems have been established as follows:
  - a. "Threshold" Settlement: No greater than 0.25 inch.
  - b. "Limiting" Settlement: No greater than 0.50 inch.
6. Criteria for "threshold" and "limiting" settlement of UMPs adjacent to the temporary lateral support systems have been established as follows:
  - a. "Threshold" Settlement: No greater than 0.25 inch.
  - b. "Limiting" Settlement: No greater than 0.50 inch.
7. Criteria for "threshold" and "limiting" angular distortion (measure of building rotation due to vertical settlement) of SMP' on adjacent buildings have been established as follows:
  - a. "Threshold" Angular Distortion: No greater than 1/1000 for wood, steel and brick buildings. No greater than 1/1200 for historical stone structures. Where the angular distortion is defined as the ratio of the differential elevation between any two building points over the horizontal distance between those points.
  - b. "Limiting" Angular Distortion: No greater than 1/750 for wood, steel and brick buildings. No greater than 1/900 for historical stone structures. Where the angular distortion is defined as the ratio of the differential elevation between any two building points over the horizontal distance between those points.

**ITEM 100.95** (Continued)

8. The Contractor shall immediately notify the Engineer and shall take immediate steps to control further movement by revising construction procedures, providing supplemental bracing or other measures (working extended hours as approved or temporarily terminating work in the area of movement if necessary) as required if any of the following occur:
  - a. Field measurements indicate that any of the "threshold" movement criteria are reached or exceeded.
  - b. Field measurements or observations indicate that significant or sustained wall movements, beyond those reasonably expected, are occurring (total movement may be less than the "Limiting" movement criteria).
  - c. Movements of adjacent structures, utilities or other facilities are detected.
9. If "Limiting" movements are being approached or reached, the Engineer and/or the Department may require the Contractor to temporarily suspend the work in the area where such movement is occurring and implement all required mitigation measures which are satisfactory to the Engineer, to arrest the movements, at no cost to the Department.
10. Installation of Work in the area where the Limiting Values had been reached shall not be permitted until the results of optical surveys indicate no increase in lateral movement of the earth support system and adjacent surface and building settlement for the one-week period immediately prior to resuming construction.
11. These criteria are intended to establish a minimum basis for the Contractor's design and procedures and do not relieve the Contractor of its responsibility for preventing detrimental movements and damage to adjacent structures, utilities or other work.
12. The Contractor shall incur damages of \$1,000 for each day the Contractor works in violation of any threshold or limiting values being reached or exceeded as determined by the Engineer.
13. In the event the Contractor does not comply with the approved mitigation plan or continues to work in violation of threshold or limiting values being reached or exceeded, the Contractor shall not be allowed to continue work until proper mitigation procedures and corrections have been made as required by the Engineer and the Department.
14. The Contractor shall be responsible for repairing all property damage caused by construction activities.

**F. Protection of Instrumentation**

Protect all instruments during the course of the Work. Any damage or loss of function caused by the Contractors operations, or by any other cause, to new or existing instrumentation devices, shall be immediately repaired or the equipment replaced at no additional cost to the Department.

**ITEM 100.95** (Continued)

**BASIS OF PAYMENT**

Item 100.95 will be paid for at the Contract lump sum price, which price shall include full compensation for all labor, materials, equipment, and incidental costs required to complete the work.

Partial payment for Item 100.95 will be on a percent of the lump sum bid calculated by dividing the elapsed time to date by the contractual construction time limit as approved by the Engineer.

**ITEM 100.99****TELEVISION INSPECTION OF SEWER PIPES****LUMP SUM**

The work under this Item shall consist of all required labor, materials, supervision, and equipment to inspect the gravity sewer line and sewer service pipes with the project limits.

Inspection shall be by means of a closed-circuit television system (CCTV). The work will include a combination of pre-construction CCTV and post-construction CCTV inspections of pipes.

CCTV work shall be completed and delivered per the National Association of Sewer Service Companies (NASSCO) Pipeline Assessment and Certification Program (PACP) standards. All operators of the CCTV equipment shall be NASSCO PACP (Pipeline Assessment Certification Program) Certified.

**MATERIALS**

The cameras used for inspection shall be designed and constructed for sewer line inspection work. The mechanical design of the lens shall allow it to turn and rotate 360 degrees to provide a close-up view of sewer pipe walls and sewer service pipes. The camera shall be designed to maintain proper orientation of the picture while the lens is turning and rotating.

The cameras shall be operative in 100% humidity conditions.

The lighting for the cameras shall be suitable to allow a clear picture of service pipes and the entire periphery of the mainline sewer pipe, such that joints, root intrusions, cracks, offset joints, deposits, etc. can be seen and identified by the Engineer.

The lens focus and rotational capabilities and the light intensity will be remotely controlled from an above ground television "studio".

The cameras shall produce a continuous, full color picture with a quality acceptable to the Engineer.

**CONSTRUCTION METHODS****Flow Control**

A minimum of 75% of the periphery of the sewer/storm line shall be visible at all times.

**Operation**

When inspecting newly constructed sewer lines, introduce water into the sewer lines to be tested from the upstream manhole prior to the television inspection, but no more than 24 hours in advance of the inspection.

Lines shall be suitably isolated from the remainder of the sewer system as required.

---

**ITEM 100.99** (Continued)

Move the cameras through the line in either direction at a uniform rate as required by the Engineer.

The Engineer may require Contractor to pull cameras back to get a second view of a section of the pipe.

Use manual winches, power winches, television cable reel powered rewinds, high-pressure hose and reels on jet-cleaning trucks, or a flexible pole, to move the camera through the sewer.

The screen monitor and winch operators shall be in full communication at all times.

Remove all wires, screens, sandbags, etc. used in the television inspection process from the sewers at the completion of inspection of each sewer section.

**Camera Measurement**

Measurement for location of defects, service connections, etc., shall be accurate to two tenths (0.2) of a foot over the length of the section being inspected.

**Records**

*CCTV File Format:* The video file shall be in a .PACP format, for integration into the City's existing Cues GraniteNET database.

The manhole numbers shall be based off the City's existing manhole numbering system. Manhole numbers shall be verified with the City's Wastewater Division prior to TV inspection. Arbitrary manhole numbering by the Contractor will not be accepted.

Printed records shall be provided, reflecting location of defects, service connections, etc., shall be recorded per PACP standards and stored to a NASSCO certified digital reporting software.

Keep records and supply to the Engineer when the work has been completed.

Show the exact location in relation to adjacent manholes, of each infiltration point discovered by the television camera.

Show locations of laterals, unusual conditions, roots, break-in storm sewer connections, collapsed sections, presence of scale and corrosion, and other discernible features.

Inventory the houses and apparent empty lots bordering each section of sewer line that is inspected and compare results to the number and location of house services found during the inspection. Log inconsistencies and report them to the Engineer.

**ITEM 100.99** (Continued)

*Video / Photographs:*

- i. Two copies of the video shall be provided in DVD format, downloaded or output from a NASSCO certified software: one to the Engineer and one to the Owner.
- ii. The video shall be digitally recorded, indexed by pipe section (labeled by manhole number or other means acceptable to the Engineer) and allow for printing of still photographs.
- iii. Digital photographs shall be submitted with a photograph log providing the following information:

Date: \_\_\_\_\_  
 Section, MH# \_\_\_\_\_ to MH# \_\_\_\_\_  
 Diameter of Sewer \_\_\_\_\_ inches  
 Distance from MH# \_\_\_\_\_ is \_\_\_\_\_

Description of item photographed  
 \_\_\_\_\_

**Schedule**

The Contractor shall perform pre-construction video inspection before subjecting pipes to construction loads or vibrations, excavating near pipes, or other construction activities that could potentially damage existing system. Post-construction inspection shall be performed after such construction activities are completed.

**Repairs**

Damage to existing sanitary pipes or structures incurred between the pre- and post-construction video surveys shall be repaired to the satisfaction of the City at no additional cost to MassDOT.

**BASIS OF PAYMENT**

Item 100.99 will be paid for at the Contract lump sum price, which price shall include full compensation for all labor, materials, equipment, and incidental costs required to complete the work, including both pre- and post-construction inspections.

No payment will be made for repairing damage to existing sewer pipes or structures caused by the Contractor’s activities.

**ITEM 107.98****STONE MASONRY CRACK REPAIRS****FOOT**

The work under this Item shall include stone masonry crack repair at the existing abutments. The work is intended to include all areas as may be reasonably inferred from the Contract Drawings and as referenced by the Specifications whether or not specifically shown on the Contract Drawings. The work this Item includes epoxy injection of cracks no more than 1/4-inch wide in the stone masonry blocks.

**MATERIALS**

Manufacturers' products and specifications are generally referred to for identification; the products of other manufacturers meeting the specifications and standards of the specified systems may be submitted for review. Check all specified items upon Contract signing and initiate submittals in time to allow early ordering so the work is not delayed. All materials are to be new, unless designated otherwise.

Epoxy shall consist of a two-component injectable epoxy of viscosity and fillers appropriate for crack widths and project conditions, and an epoxy gel for surface-sealing cracks for epoxy injection and setting injection ports. Mix epoxy with granite aggregate of the same color as the adjacent stone with particles that pass through a No. 50 sieve and are retained on a No. 200 sieve. Use the products listed below, or equivalent, as shown on the drawings and called for in the specifications:

1. Denepox I series (injectable epoxy) and Denepox Gel (epoxy gel), manufactured by De Neef Construction Chemicals, Inc., 5610 Brystone Drive, Houston, TX 77041, 800-732-0166, [www.deneef.com](http://www.deneef.com)
2. Bonstone Crack Repair Series (injectable epoxy) and Last Patch™ Gel (epoxy gel), manufactured by Bonstone Materials Corporation, 707 Swan Drive, Mukwonago, WI 53149, 800-425-2214, [www.bonstone.com](http://www.bonstone.com)
3. Sikadur 3x Series (injectable epoxy) and Sikadur 31 Gel (epoxy gel), manufactured by Sika Construction, 201 Polito Avenue, Lyndhurst, NJ 07071, 800-933-7452, [www.sika.com](http://www.sika.com)

**CONSTRUCTION METHODS**

The Contractor performing the work shall have a minimum of five (5) years of experience in comparable restoration masonry and employing workers skilled in the restoration processes and operations indicated.

Deliver materials to site in manufacturer's original and unopened containers and packaging, bearing labels indicating type and names of products and manufacturers. Protect materials during storage and construction. Keep containers tightly closed and away from open flames. Protect liquid components from freezing. Comply with manufacturer's recommendations for minimum and maximum temperature requirements for storage. Comply with manufacturer's recommendations for handling materials.

**ITEM 107.98** (Continued)

Examine all surfaces scheduled to receive repairs for roughness, contaminants, moisture, unsound structural substrates, or other conditions that may impair the repair applications. Notify the Engineer in writing of any such conditions; do not commence work until all defects are remedied.

Repair all cracks no more than 1/4-inch wide following the procedures below and conforming to manufacturer's recommendations. The final crack repair procedure shall be approved by the Engineer prior to any work being performed.

Clean interior of cracks by flushing water under low pressure (<100 psi). Use compressed air to dry interior surfaces of crack with oil free compressed air. Do not allow cracks to be contaminated with oils.

Seal crack perimeter, including along the inside face where accessible, and install injection ports. Provide temporary packing in open joints to limit joint contamination by surface seal and crack repair epoxy. Remove any such packing and contamination after injection.

Inject epoxy sequentially from the bottom to top using successive ports until the crack has been filled.

Remove injection ports and epoxy seal material used to contain epoxy along crack perimeter.

Take all required precautions to prevent debris, water, or masonry repair products, etc. from contaminating the land or the water. Any notification and cleanup procedures required to abate contamination in sediments or water shall be the responsibility of the Contractor.

Clean work areas daily. Remove epoxy materials from any adjacent surface promptly. Upon completion of work, thoroughly clean work areas.

**Submittals**

Provide the following submittals prior to the commencement of work:

1. Manufacturer's technical literature describing all materials to be used for the work including instructions for storage, handling, installation, use, and Material Safety Data Sheets. Prior to delivery, submit to the Engineer certificates attesting to compliance with the applicable Specifications' reference standards.
2. For Contractor/Subcontractor, mechanics, and manufacturers, a list of similar projects completed in the last five (5) years.
3. Sequence of work.



**ITEM 107.98** (Continued)

**METHOD OF MEASUREMENT**

Item 107.98 will be measured for payment by the foot of stone masonry cracks repaired, complete in place.

**BASIS OF PAYMENT**

Item 107.98 will be paid for at the Contract unit bid price per foot, which price shall include all labor, materials, equipment, and incidental costs required to complete the work.

**ITEM 107.99****STONE MASONRY POINTING REPAIRS****FOOT**

The work under this Item shall include stone masonry pointing repairs at the existing abutments.

The work is intended to include all areas as may be reasonably inferred from the Contract Drawings and as referenced by the Specifications whether or not specifically shown on the Contract Drawings. The work this Item includes repointing of masonry and mortar joints between stone blocks above the observed water line. The work also includes injection-grouting to fill the joint if the repair depth is deeper than 3 inches.

**MATERIALS**

Manufacturers' products and specifications are generally referred to for identification; the products of other manufacturers meeting the specifications and standards of the specified systems may be submitted for review. The burden of proof for "equivalent" materials is on the Contractor, who shall bear the costs and delays involved in the Engineer's review of substitutions. All materials are to be new, unless designated otherwise.

**Grout for joint-filling (repair depth > 3 inches)**

Pumpable, underwater, cement-based, non-shrink grout with anti-washout agents specifically designed for use in underwater and in tidal zone applications. Use the products listed below, or equivalent:

1. UW Grout manufactured by SpecChem, 444 B Richmond Ave, Kansas City, KS 66101, 866-791-8700, [www.specchemllc.com](http://www.specchemllc.com)
2. Cementitious Underwater Grout manufactured by Five Star Marine, Inc. 750 Commerce Drive, Fairfield, CT 06825, 800-338-3145, [www.5star-marine.com](http://www.5star-marine.com)
3. Seashield 510<sup>TM</sup> Underwater Grout manufactured by Denso® North America, 9710 Telge Road, Houston, TX 7095, 281-369-9628, [www.densona.com](http://www.densona.com)

**Mortar for pointing**

Cementitious patching mortar with anti-washout agents and a minimum 28-day compressive strength of 4000 psi, specifically designed for use in underwater and tidal zone applications. Use the products listed below, or equivalent:

1. Material: SpeedCrete BlueLine by W.R. Meadows, 300 Industrial Drive, Hampshire, IL 60140, 800-342-5976, [www.wrmeadows.com](http://www.wrmeadows.com)
2. Material: Structural Concrete Underwater HP manufactured by Five Star Marine, Inc., 750 Commerce Drive, Fairfield, CT 06825, 800-338-3145, [www.5star-marine.com](http://www.5star-marine.com)
3. Material: MasterSeal® 590 by Master Builders Solutions Construction Systems US, LLC, 889 Valley Park Drive, Shakopee, MN 55379, 800-433-9517, [www.master-builders-solutions.com](http://www.master-builders-solutions.com)

**ITEM 107.99** (Continued)**Accessories**

Plastic shims of various thicknesses, at least 6-inch long and 2-inch wide, for support of granite blocks during removal of existing mortar and repointing work.

**CONSTRUCTION METHODS**

The Contractor performing the work shall have a minimum of five (5) years of experience in comparable restoration masonry and employing workers skilled in the restoration processes and operations indicated.

All material shall be delivered, stored and handled so as to prevent deterioration or the intrusion of any foreign matter. Packaged material shall be delivered and stored in the original packages. Materials in broken packages or showing evidence of damage will be rejected. Store materials unopened until required for use. Store packaged materials above ground on platforms permitting air circulation under materials. Completely cover all materials to protect from weather, moisture, and neglect. Materials shall not be stored in such a manner as to damage or place undue stress on the existing structure.

Contractor shall comply with all testing requirements as applicable and established by the Massachusetts Department of Transportation, and all other governing bodies. The Contractor shall bear the costs of independent special inspectors and testing as required. If such tests or inspections indicate that the work does not conform to the Specifications, the Contractor shall bear the costs of all retesting and re-inspections. At start of job, and once per week during construction, the Contractor shall test the mortar and provide results to the Engineer to demonstrate that the mortar meets the compressive strength requirements of ASTM C270. Mortar compressive strength requirements are: Type N Mortar – 750 psi.

**Reference standards**

The following Standards are used as a reference for this work:

- ASTM C144 – Specifications for Aggregate for Masonry Mortar
- M4.01.1 ASTM C150 – Specifications for Portland Cement
- ASTM C207 – Specifications for Hydrated Lime for Masonry Purposes
- ASTM C270 – Mortar for Unit Masonry
- ASTM C780 – Standard Test Method for Preconstruction and Construction Evaluation of Mortars for Plain and Reinforced Unit Masonry
- TMS 402/602

**Environmental Protection, Compliance and Monitoring Requirements**

Comply with all permits issued for the project, and Federal, State, and municipal laws, regulations, and ordinances that require protection of the environment, including laws and regulations whose purpose is to prevent contamination and pollution of the air, water, and soil in and surrounding the work site.

---

**ITEM 107.99** (Continued)**Water Quality**

Take all required precautions to prevent debris, aggregates, cleaners, and wash-water from masonry-repointing-related activities from entering the water. Any notification and cleanup procedures required to abate contamination in sediments or water shall be the responsibility of the Contractor. All materials must be collected, removed from the site and disposed of legally.

**Mortar removal**

The procedure for removing existing mortar shall be submitted to the Engineer for approval. When cutting mortar with a rotary saw or hand tools, remove only mortar. Do not chip or cut into granite blocks with saw or hand tools. Repair or replace granite blocks damaged due to mortar removal. Remove all mortar from joints to 3 in. minimum depth, or to a depth to remove all deteriorated mortar, whichever is greater. Remove mortar at T-joints with a hammer and chisel. As mortar is removed, install shims at areas where the stability of the masonry depends on the continuous bearing of the block on the mortar. After removing existing mortar, blow out dust and mortar particles using compressed air. Ensure that surfaces to be repointed are not contaminated with oil from the air blower.

**Mortar & Grout mixing**

Control the batching procedure to provide proper proportions by measuring materials by volume. Mix all cementitious materials, sand, and water thoroughly in a mechanical batch-mixer using the minimum amount of water to produce a workable consistency. Mix materials in strict accordance with manufacturer's recommendations. All mortar and grout must be placed within 2 hours of initial mixing.

**Injection Grouting**

Where repair depth is greater than 3 inches, injection grouting shall be used to fill the joint as shown in the Contract Drawings and described herein. Install injection ports in joints. Inject grout sequentially from bottom to top and laterally using successive ports until the joints have been filled and grout can be seen emanating from the adjacent ports. Cure grout in accordance with manufacturer's recommendations. Allow grout to set a minimum of seven days prior to removal of shims. After joints are filled and grout is cured, remove the injection ports and repair injection port holes with pointing mortar.

**Pointing**

Dampen the joint to be pointed prior to pointing with a fine mist sprayer. Do not introduce large amounts of water into the wall cavity. The masonry must absorb all surface water. Pack the mortar tightly into the joint in areas between shims in lifts and as recommended by the manufacturer. Tool joint to a flat profile to match existing mortar. When final lift is thumbprint hard, remove excess mortar from adjacent granite by brushing. Cure mortar in accordance with manufacturer's recommendations. Allow mortar to set a minimum of seven days prior to removal of shims. Remove shims and repeat pointing procedure at gaps left at shim locations. Wipe off all excessive mortar as the work progresses. Dry brush at the end of the day.

**ITEM 107.99** (Continued)

**Cleaning excess mortar**

Clean exposed surfaces of excess mortar and foreign matter using stiff nylon or bristle brushes and clean water, spray-applied at very low pressure (<100 psi), as the work progresses.

**Submittals**

Provide the following submittals prior to the commencement of work:

1. Manufacturer's technical literature describing all materials to be used for the work including instructions for storage, handling, installation, use, and Material Safety Data Sheets. Prior to delivery, submit to the Engineer certificates attesting to compliance with the applicable Specifications' reference standards.
2. For Contractor/Subcontractor, mechanics, and manufacturers, a list of similar projects completed in the last five (5) years.
3. A detailed, project-specific work plan that includes sequence of work and procedures for access and material handling.

**METHOD OF MEASUREMENT**

Item 107.99 will be measured for payment by the Foot of stone masonry pointing repairs, complete in place.

**BASIS OF PAYMENT**

Item 107.99 will be paid for at the Contract unit price per foot, which price shall include all labor, materials, equipment, and incidental costs required to complete the work.

**ITEM 114.1**

**DEMOLITION OF SUPERSTRUCTURE OF  
BRIDGE NO. F-04-010**

**LUMP SUM**

The work under this Item shall conform to the relevant provisions of Subsection 112 of the Standard Specifications and the following:

The work, demolition of the existing superstructure, shall include sawcutting, removal, and disposal of designated elements. The existing superstructure shall be removed in stages as shown on the Contract Drawings or as required by the Engineer. The superstructure contains metal railings, reinforced concrete sidewalks, bituminous concrete, and reinforced concrete deck, painted steel beams and bracing, and steel bearings at the abutments and center pier. Demolition shall also include brick backwall, timber forms, and removal of existing Verizon ducts. Except as specified, all material and debris shall become property of the Contractor, and shall be recycled, reused or disposed of properly.

The Contractor shall take required precautions to protect existing utilities in place from damage during his/her operations. These utilities include all connections at approaches, manholes, and those that run below the abutments and through the river, including the City of Fitchburg's under river gravity sewer.

Construction Methods must include the Contractor sole responsibility for maintaining the stability of the existing bridge at all times during the demolition and construction operations and proposed demolition sequence, procedures, and methods to be used including, but not limited to, equipment, tools, devices, crane capacity, schedule of operations, methods of utility protection, etc.

The Contractor shall be aware that the existing waterproof membrane over the bridge deck and existing utility pipes may contain asbestos and must be tested to determine whether or not they contain asbestos.

MassDOT does not guarantee or represent that the bridge materials will actually coincide with any descriptions contained herein or represented on the Plans. The Contractor is advised to conduct a field investigation prior to bidding. Contractor shall verify all conditions, dimensions and materials in the field and shall base his/her bid on his/her own findings without any additional compensation for variances from the Plans or these Special Provisions regarding actual conditions for the materials to be removed.

**ITEM 114.1** (Continued)**CONSTRUCTION METHODS**

The Contractor shall submit to the Engineer for review and approval a Demolition Plan, stamped by a Professional Structural Engineer registered in the Commonwealth of Massachusetts, indicating the methods the Contractor intends to implement to perform the required demolition of existing superstructure Bridge No. F-04-010 including but not limited to equipment, tools, devices, crane capacity and location. It shall also include a schedule of operations, methods of utility protection, shielding design, dust control, and disposal location. Due to the deteriorated condition of the existing structure, the demolition plan shall include calculations verifying the capacity of the existing structure under construction loads. The Contractor shall be solely responsible for maintaining the stability of the existing structure at all times during demolition and construction operations.

The demolition procedures and any required calculations and drawings shall bear the stamp of a Professional Engineer (Structural Engineer) registered in the Commonwealth of Massachusetts certifying that all existing structural members are suitably braced and supported throughout the demolition process. Work shall not commence until the Engineer has given written approval of the method of demolition. Any lifting plans and supporting calculations for the demolition procedure shall conform to the requirements of Subsection 960 of the Standard Specifications for the submittal. The Contractor's demolition method shall take into consideration any utilities and drainage structures near the bridge. Debris from construction must be carefully contained within the work zone and prevented from falling into the North Nashua River and areas adjacent to the abutments. The Contractor shall be required to remove any debris which is generated by demolition from the site immediately and to restore portions of the site affected by the operation to their original undisturbed condition or better. The Contractor shall also be responsible for dust control due to the demolition operation. The Contractor shall take care not to damage any existing structural components that have been designated to remain, or any newly constructed structural components, as shown on the Plans. Any structural components so designated that are damaged or otherwise made unsatisfactory for continued use by the Contractor's operations, as determined by the Engineer, shall be replaced or repaired to the satisfaction of the Engineer by the Contractor at his/her own expense.

Demolition debris containment or temporary shielding shall be provided without installing supporting structures within the waterway and prevent any debris, tools or incidental equipment of any kind resulting from demolition, excavation or construction from falling into the river. The Contractor shall include designing, furnishing, installing, maintaining, relocating, removal and disposal of the protective shielding incidental to this Item. Any material that falls into the River below during the demolition process shall be removed immediately and at the Contractor's expense.

The Contractor is responsible for any damages to existing ornamental fence during construction.

**ITEM 114.1** (Continued)**BASIS OF PAYMENT**

Item 114.1 will be paid for at the Contract Lump Sum price, which price shall include all labor, transportation, equipment, tools, disposal fees required, permits, or incidental costs required to complete the work as specified above including field survey, demolition and work involving painted steel, installation and removal of temporary shielding system as required. All costs for permits, dump fees, taxes, special handling of hazardous materials (except for the inspection, testing, removal and disposal of asbestos, which is paid for under Items 182.1 and 182.21, and disposal of treated wood products, which is paid for under Item 184.1), etc., shall be included under this Item. Miscellaneous removals and disposals that are not specifically listed for payment under another bid item shall be included under this Item.

All materials removed under Item 114.1 shall become the property of the Contractor and shall be removed from the job site or disposed of in accordance with all applicable Local, State, and Federal requirements, unless such materials are designated to be reused in the proposed construction.

Monitoring of existing abutments during the demolition will be paid for separately under Item 100.95 Geotechnical Monitoring and Instrumentation.

Removal of portions of the substructures that include reinforced concrete, as shown on the plans, will be paid for separately under Item 127.1, Reinforced Concrete Excavation.

**SCHEDULE FOR BASIS OF PARTIAL PAYMENT**

Payment of fifty percent (50%) of the Contract price shall be made upon completion of work in Phase 1A as required and as approved by the Engineer.

Payment of the remaining fifty percent (50%) of the Contract price shall be made upon the completion of the work in Phase 2A as required and as approved by the Engineer.



**ITEM 127.1****REINFORCED CONCRETE EXCAVATION****CUBIC YARD**

The work under this Item shall conform to the relevant provisions of Subsections 112, 120, and 140 of the Standard Specifications and the following:

The work shall include furnishing of all labor, materials, and equipment required for the removal and satisfactory disposal of existing abutment backwalls, beam seats and wingwalls to the limits as shown on the Plans and as specified herein or as required by the Engineer.

The removal of stone masonry courses at the abutments is covered under Item 140. Bridge Excavation.

The Contractor shall take required precautions to protect existing utilities in place from damage during his/her operations. In addition, the Contractor is required to remove all dust, loose concrete and debris encountered as part of the excavation prior to installation of the new concrete.

**CONSTRUCTION METHODS**

The Contractor shall submit to the Engineer a demolition procedure for the work pertaining to Item 127.1 for review and approval by the Engineer. The submittal shall be stamped and signed by a Professional Engineer registered in the Commonwealth of Massachusetts. The submittal shall contain a complete description of the equipment and construction methods proposed for the reinforced concrete excavation work.

The procedure shall meet the requirements for a submittal of a demolition procedure contained under Item 114.1 Demolition of Superstructure of Bridge of these Special Provisions. As a minimum, the following information shall be included in the submittal:

1. A written sequence of the specific steps required for reinforced concrete excavation procedure. It shall include a location plan with estimated timeframes to complete work in coordination with the Construction Schedule.
2. A complete description of the equipment, tools and proposed construction methods including cut sheets. See Construction Methods for limitations on acceptable equipment.
3. A plan and drawings with details of temporary protective shielding containment enclosures, in coordination with the demolition procedure to ensure all debris is kept from entering the waterway.

Plan sequencing shall address installation of Item 953.1 Temporary Support of Excavation. The Contractor shall not proceed with excavation until the Engineer has given written acceptance of the plan.

**ITEM 127.1** (Continued)

**Prosecution of Work**

Limits of reinforced concrete excavation shall be sawcut where possible prior to demolition.

During the prosecution of the work under this item, the Engineer may reject the use of any method of equipment that causes possible damage to the remaining structure or any part thereof. Pneumatic hammers heavier than the nominal 25 pounds mass shall not be used, unless approved by the Engineer.

The Contractor shall limit extents of excavation of existing abutments as shown on the contract drawings. The Contractor shall take all precautions required so as not to damage those portions of existing abutments that are to remain. Damage caused by the Contractor beyond the approved limits of excavation shall be repaired at no expense to MassDOT.

All debris from concrete excavation shall be captured and removed from the site and will not be allowed to enter environmentally sensitive areas as required under project permits. All materials shall be properly disposed of by the Contractor. All temporary protective shielding required for the safe performance of this work, outside of that provided under Item 114.1, shall be considered incidental to this Item.

**METHOD OF MEASUREMENT**

Item 127.1 will be measured for payment by the cubic yard of reinforced concrete excavated, based on the limits shown on the Plans or as required by the Engineer.

**BASIS OF PAYMENT**

Item 127.1 will be paid for at the Contract unit price per cubic yard, which price shall constitute full payment for excavation, saw cutting, removal, proper off-site disposal of all excavated materials, temporary protective shielding, furnishing of all tools, labor, equipment, transportation, and incidental costs required to complete the work.

**ITEM 140.****BRIDGE EXCAVATION****CUBIC YARD**

The work under this Item shall conform to the relevant provisions of Subsections 112, 120, and 140 of the Standard Specifications and the following:

The work shall include furnishing of all labor, materials, and equipment required for the removal and proper disposal of stone masonry at the existing abutments and existing flood wall at the proposed drainage outfall to the limits as shown on the Plans and as specified herein.

The Contractor shall take required precautions to protect the existing substructure that is to remain in place from damage during his/her operations.

**CONSTRUCTION METHODS**

The Contractor shall prepare and submit a Stone Masonry Excavation Plan to the Engineer for review describing the proposed sequence, method of excavation, equipment for the excavation and disposal of all materials. Plan sequencing shall address installation of Item 953.1 Temporary Support of Excavation. The Contractor shall not proceed with excavation until the Engineer has given written acceptance of the plan.

**Prosecution of Work**

The limits of bridge excavation shall be at stone masonry joints to the greatest extent possible. Use hand tools to break the mortar at the joints prior to removing the stone masonry. The surface of the remaining stone masonry upon which concrete is to be placed shall be freed from all loose fragments, cleaned to a firm surface. Where excavation up to the stone masonry joints is not possible or practical, sawcut the stone to provide a clean and straight concrete edge. The sawcut edges shall be cleaned and freed from all loose fragments.

During the prosecution of the work under this item, the Engineer may reject the use of any method of equipment that causes possible damage to the remaining structure or any part thereof. Pneumatic hammers heavier than the nominal 25 pounds mass shall not be used, unless approved by the Engineer.

The Contractor shall limit extents of excavation of existing abutments as shown on the contract drawings, or as required by the Engineer. The Contractor shall take all precautions required so as not to damage those portions of existing abutments that are to remain. Damage caused by the Contractor beyond the approved limits of excavation shall be repaired at no expense to MassDOT.

Based on available City records, there are existing trolley tracks under the road surface behind both existing abutments. The Contractor's attention is drawn to the fact that remnants of these tracks and associated concrete may be within the established excavation limits and shall be removed as part of the scope of this item.

All debris from bridge excavation shall be captured and removed from the site and will not be allowed to enter environmentally sensitive areas as required under project permits. All materials shall be properly disposed of by the Contractor in accordance with all applicable Local, State, and Federal requirements.

**ITEM 140.** (Continued)

**METHOD OF MEASUREMENT**

Item 140. will be measured for payment per Subsection 140.80 of the Standard Specifications.

**BASIS OF PAYMENT**

Item 140. will be paid per Subsection 140.81 of the Standard Specifications.

All temporary protective shielding required for the safe performance of this work, outside of that provided under Item 114.1, shall be considered incidental to this Item.

**ITEM 153.1**

**CONTROLLED DENSITY FILL**  
**- NON-EXCAVATABLE**

**CUBIC YARD**

The work under this Item shall conform to the relevant provisions of Subsection 150 of the Standard Specifications and the following:

The work shall include the furnishing and placement of Controlled Density Fill Non-Excavatable for backfilling at highway guardrail transition bases as shown on the Contract Drawings, or as required by the Engineer.

**MATERIALS**

Controlled Density Fill (CDF) Non-Excavatable shall meet the requirements of CDF Type 2 specified in Subsection M4.08.0 of Division III, Materials in the Standard Specifications. The CDF producer and the mix design shall be on MassDOT's Qualified Construction Materials List (QCML).

**CONSTRUCTION METHODS**

CDF Non-Excavatable shall be produced and delivered using standard concrete construction equipment and shall be discharged directly from the mixer truck into the trench. CDF Non-Excavatable shall not be placed on frozen ground or when the air temperature is below 40 degrees F.

**METHOD OF MEASUREMENT**

Item 153.1 will be measured for payment by the cubic yard of CDF complete in place, to the limits specified on the plans, or as required by the Engineer.

**BASIS OF PAYMENT**

Item 153.1 will be paid for at the Contract unit price per cubic yard, which price shall include all labor, material, equipment, and incidental costs required to complete the work.

**ITEM 156.13 CRUSHED STONE FOR INTEGRAL ABUTMENT PILES TON**

The work under this Item shall conform to the relevant provisions of Subsection 150 of the Standard Specifications and the following:

The work shall include the furnishing and placement of crushed stone for filling pre-drilled holes for integral abutment piles as shown on the Contract Drawings or as required by the Engineer.

**MATERIALS**

Crushed Stone for Integral Abutment Piles shall meet the requirements specified in Subsection M2.01.6 of Division III, Materials in the Standard Specifications.

At both abutments at each pile, the pre-drilled 2'-6" minimum diameter hole and 6" minimum deep by 3'-7" minimum wide trench shall be filled with uncompacted crushed stone after installing or driving the piles.

**METHOD OF MEASUREMENT**

Item 156.13 will be measured for payment per Subsection 150.80 of the Standard Specifications.

**BASIS OF PAYMENT**

Item 156.13 will be paid for per Subsection 150.81 of the Standard Specifications.

Pre-drilling holes for the integral abutment piles and any required casings will be paid for separately under Item 944.2 Pre-drilling for Piles.

---

**ITEM 180.01 ENVIRONMENTAL HEALTH AND SAFETY PROGRAM - LUMP SUM**

The work shall consist of ensuring the health and safety of the Contractor's employees and subcontracting personnel, the Engineer, their representatives, the environment, and public welfare from any on-site chemical contamination present in air, soil, water and sediment.

The Contractor shall prepare and implement a site-specific Environmental Health and Safety Plan (EHASP) which has been approved and stamped by a Certified Industrial Hygienist (CIH) and includes the preparer's name and work experience. The EHASP shall include appropriate components required by OSHA Standard 29 CFR 1910.120(b) and the Massachusetts Contingency plan (MCP) 310 CMR 40.0018 and must comply with all applicable state and federal laws, regulations, standards and guidelines, and provide a degree of protection and training appropriate for implementation on the project. The EHASP shall be a dynamic document with provision for change to reflect new information, new practices or procedures, changing site environmental conditions or other situations which may affect site workers and the public. The EHASP shall be developed and implemented independently from the standard construction HASP required to work on all MassDOT construction projects.

Health and safety procedures provided by the Contractor shall comply with all the appropriate regulations that address employee working conditions, including but not limited to standards established by OSHA and National Institute for Occupational Safety and Health (NIOSH). Equipment used for the purpose of health and safety shall be approved by and meet pertinent standards and specifications of the appropriate regulatory agencies.

A copy of the most up-to-date version of the EHASP shall be maintained on-site at all times by the Contractor. The on-site copy shall contain the signature of the Engineer and each on-site employee of the MassDOT, Contractor, and Subcontractors involved with on-site activities. The employee's signature on the EHASP shall be deemed prima facie evidence that the employee has read and understands the plan. Updated copies of signature sheets shall be submitted to the Engineer.

The EHASP shall specify a Contractor Site Safety and Health Officer responsible for implementation of the EHASP and to oversee all construction activities, including handling, storage, sampling and transport, which require contact with or exposure to potentially hazardous materials.

The level of protection, required to ensure the health and safety of on-site personnel will be stipulated in the EHASP. The Site Safety and Health Officer shall implement the EHASP based on changing site and weather conditions, type of operation or activity, chemical compounds identified on-site, concentration of the chemicals, air monitoring data, physical state of the hazardous materials, potential duration of exposure to hazardous materials, dexterity required to perform work, decontamination procedures, necessary personnel and type of equipment to be utilized.

**ITEM 180.01** (Continued)

During implementation of the EHASP, a daily log shall be kept by the Site Safety and Health Officer and a copy shall be provided weekly to the Engineer. This log shall be used to record a description of the weather conditions, levels of personal protection being employed, screening data and any other information relevant to on-site environmental safety conditions. The Site Safety and Health Officer shall sign and date the daily log.

**METHOD OF MEASUREMENT AND BASIS OF PAYMENT**

Preparation and implementation of the Environmental Health and Safety Program, including the monitoring, protection and storage of all contaminated materials, as well as subsequent modifications to the EHASP, will be measured and paid for at the Lump Sum Bid Price.

Payment of 50% of the Environmental Health and Safety Program contract price will be made upon the initial acceptance of the EHASP by the Engineer. Payment of the remaining 50% of the Environmental Health and Safety Program contract price will be made upon completion of the work. The bid price shall include preparation and implementation of the EHASP as well as the cost for its enforcement by the Site Safety and Health Officer along with any necessary revisions and updates. The work of implementing the Environmental Health and Safety Program includes work involving, but not limited to, the monitoring, protection, and storage of all contaminated materials.



**ITEM 180.02**

**PERSONAL PROTECTION LEVEL C UPGRADE**

**HOUR**

The work shall consist of providing appropriate personal protective equipment (PPE) for all personnel in an area either containing or suspected of containing a hazardous environment.

Contingencies for upgrading the level of protection for on-site workers will be identified in the EHASP and the Contractor shall have the capability to implement the personal protection upgrade in a timely manner. The protective equipment and its use shall be in compliance with the EHASP and all appropriate regulations and/or standards for employee working conditions.

Personal Protection Level C Upgrade will be measured and paid only upon upgrade to Level C and will be at the contract unit price, per hour, per worker, required in Level C personal protection. No payment will be made to the Contractor to provide Level D PPE.

**ITEM 180.03****LICENSED SITE PROFESSIONAL SERVICES****HOUR**

Within limited areas of the project site, soils, sediments and/or groundwater may be contaminated. A Licensed Site Professional (LSP) shall be required to provide the services necessary to comply with the requirements of the MCP. These services may include sampling, analysis and characterization of potentially contaminated media, preparation of Immediate Response Action (IRA) Plans, Utility-Related Abatement Measure (URAM) and Release Abatement Measure (RAM) Plans, Imminent Hazard Evaluations, status reports, transmittal forms, release notification forms, risk assessments, completion statements, and related documents required pursuant to the Massachusetts Contingency Plan (MCP). LSP hours related to the characterization and disposal of contaminated soil and/or sediment are incidental to the disposal items. An estimate of LSP services to be provided shall be submitted to the Engineer for approval before any LSP activity begins.

The name and qualifications of the LSP and all environmental technicians to be assigned to the project shall be submitted to the Engineer for approval at least four weeks prior to initial site activities. The LSP shall have a current, valid license issued by the Massachusetts Board of Registration of Hazardous Waste Site Cleanup Professionals. The LSP shall have significant experience in the oversight of MCP activities at active construction sites. Qualification packages for the LSP and each technician shall include a resume, all recent work assignments with responsibilities identified (previous 5 years), and applicable training and certifications. A list of all Notices of Noncompliance, Notice of Audit Findings and Enforcement Orders issued by the DEP shall be submitted for all work assignments listed for the LSP and environmental technicians.

The LSP shall evaluate soil and/or sediment with discoloration, odor, and presence of petroleum liquid or sheening on the groundwater surface, or any abnormal gas or materials in the ground which are known or suspected to be oil or hazardous materials. Excavated soil and sediment which is suspected of petroleum contamination shall be field screened using the jar headspace procedures according to established DEP Guidance. All field screening equipment must be pre-approved by the Engineer. The LSP shall ensure proper on site calibration of all field screening instrumentation.

The Engineer shall be contacted immediately when observations or any field screening results verify contamination requiring further analysis, and/or enhanced management of suspect soil and/or sediment. Any enhanced management of contaminated soil to ensure proper stockpiling and storage is incidental to the LSP Services item. The LSP shall adequately characterize subsurface conditions prior to backfill in areas where contaminated material has been excavated. The Engineer shall approve the locations of the testing sites prior to the sampling.

**ITEM 180.03** (Continued)

Contaminated soil, sediment and/or groundwater shall be handled in accordance with all applicable state and federal statutes, regulations and policies. The LSP shall adequately characterize contaminated media for comparison to the requirements of the MCP. The Contractor and the LSP shall be aware of the reporting requirements for releases of oil and/or other hazardous material (OHM) as set forth in federal and state laws and regulations, and shall both be held responsible for performing the work in accordance with all applicable Federal and State laws and regulations. The LSP shall maintain written records in a clear and concise format which tracks the excavation, stockpiling, analysis and reuse/disposal of all suspect contaminated soils, sediments and groundwater. These records shall be up-to-date and available to the Engineer on a bi-weekly basis. The LSP shall review and summarize the laboratory data from any analyses performed on contaminated media. A report shall be delivered to the Engineer outlining the material sampling methods, laboratory analysis results and proposed course of action. The laboratory report together with Chain of Custody forms for all analytical results shall be submitted to the Engineer within 14 days after completion of such analyses.

The LSP and Contractor shall be held responsible for the submission of all MCP-related documents to the Engineer at least 14 days in advance of any timeframe specified in the MCP and for the timely submission of data and tracking information as noted within this Item. All documents prepared under this Item must be reviewed and signed by the approved LSP. The Contractor and LSP shall be responsible for all fines, penalties and enforcement requirements imposed by applicable regulatory agencies for failure to meet regulatory and contract timeframes. No compensation will be provided for such fines, penalties and enforcement actions.

The Contractor and the LSP shall be aware of the reporting requirements for releases of oil and/or other hazardous material (OHM) as set forth in federal and state laws and regulations, and shall both be held responsible for performing the work in accordance with all applicable Federal and State laws and regulations.

If the Contractor causes a release of OHM, the Contractor shall be responsible for assessing and remediating the release in accordance with all pertinent State and Federal regulations, including securing the services of a LSP, at his own expense.

The LSP shall coordinate all activities involving both MassDOT and the DEP through the Engineer. Any notification of release shall be approved by the Department before submittal to the DEP, except if an imminent hazard condition exists as defined in 309 CMR 4.03(4)(b).

**ITEM 180.03** (Continued)**LABORATORY TESTING IN SUPPORT OF LSP SERVICES**

Laboratory testing provides for analytical testing in support of LSP services related to maintaining MCP compliance, such as delineating the extent and type of contamination present. Sampling and testing for disposal purposes are not included.

In order to maintain compliance with the MCP or other regulatory requirements, the LSP shall request approval from the Engineer to obtain samples from various locations and depths within the project area and to perform laboratory analyses on those samples. The samples shall be delivered to a DEP-certified laboratory using proper chain-of-custody documentation for analyses which, depending upon site conditions and suspected and/or identified contaminants of concern, may include, but are not limited to, metals, polychlorinated biphenyls (PCBs), volatile organic compounds (VOCs), semivolatile organic compounds (SVOCs), pesticides, polycyclic aromatic hydrocarbons (PAHs), extractable petroleum hydrocarbons (EPHs) and volatile petroleum hydrocarbons (VPHs). Subsequent testing, depending upon initial results, may be required for Toxicity Characteristic Leaching Procedure (TCLP) analyses (EPA Method 1311) for metals.

**METHOD OF MEASUREMENT AND BASIS OF PAYMENT**

LSP Services for work under this item will be measured per person, per hour of service provided by LSP, Environmental Technicians and other approved personnel. Travel time shall not be included in the billable hours. LSP hours related to soil/sediment disposal (disposal characterization, landfill acceptance, disposal package preparation, etc.) shall be incidental to disposal items.

The quantity and type of laboratory tests must be approved by the Engineer beforehand. The contractor will be reimbursed upon satisfactory written evidence of payment. The contractor may be required to obtain cost estimates from three DEP certified laboratories for the Engineer to choose the service provider. Laboratory testing related to soil/sediment disposal (disposal characterization, landfill acceptance, disposal package preparation, etc.) shall be incidental to disposal items.

LSP Services will be paid at the Contractor bid price for each hour, or fraction thereof, spent to perform the work as described above. The bid price shall be a blended rate that includes the cost of the LSP, environmental technicians and other personnel, the performance of all work tasks and field screening, including required equipment, materials and instrumentation, and production of all documentation described above. All requests for payment must be accompanied by the following information: the names of the personnel associated with the work charged under LSP Services, dates and hours worked, work conducted, including, where appropriate, locations as identified on the construction plans, and a copy of the field diary for the dates submitted.

Laboratory Testing will be reimbursed upon receipt of paid invoices for testing approved by the Engineer.

|                           |  |                   |
|---------------------------|--|-------------------|
| <b><u>ITEM 181.11</u></b> | <b><u>DISPOSAL OF UNREGULATED SOIL</u></b>                           | <b><u>TON</u></b> |
| <b><u>ITEM 181.12</u></b> | <b><u>DISPOSAL OF REGULATED SOIL -<br/>IN-STATE FACILITY</u></b>     | <b><u>TON</u></b> |
| <b><u>ITEM 181.13</u></b> | <b><u>DISPOSAL OF REGULATED SOIL -<br/>OUT-OF-STATE FACILITY</u></b> | <b><u>TON</u></b> |
| <b><u>ITEM 181.14</u></b> | <b><u>DISPOSAL OF HAZARDOUS WASTE</u></b>                            | <b><u>TON</u></b> |

The work under these Items shall include the transportation and disposal of contaminated material excavated, or excavated and stockpiled. It shall also include the cost of any additional laboratory analyses required by a particular disposal facility beyond the standard disposal test set.

Excavation of existing subsurface materials may include the excavation of contaminated soils. The Contractor shall be responsible for the proper coordination of characterization, transport and disposal, recycling or reuse of contaminated soils. Disposal, recycling or reuse will be referred to as "disposal" for the purposes of this specification. However, regardless of the use of the term herein, there will be no compensation under these items for reuse within the project limits. The Contractor will be responsible for coordinating the activities necessary for characterization, transport and disposal of contaminated soils. Such coordination will include the Engineer and his/her designee overseeing management of contaminated materials. Contaminated soils must be disposed of in a manner appropriate for the soil classification as described below and in accordance with the applicable laws of local, state and federal authorities. The Contractor shall be responsible for identifying disposal facility (ies) licensed to accept the class of contaminated soils to be managed and assure that the facility can accept the anticipated volume of soil contemplated by the project. The Contractor shall be responsible for hiring a Licensed Site Professional (LSP) and all ancillary professional services including laboratories as needed for this work. The Contractor will be responsible for obtaining all permits, approvals, manifests, waste profiles, Bills of Lading, etc. subject to the approval of the Engineer prior to the removal of the contaminated soil from the site. The Contractor and LSP shall prepare and submit to the Engineer for approval all documents required under the Massachusetts Contingency Plan (MCP) and related laws and environmental regulations to conduct characterization, transport, and disposal of contaminated materials.

### **CLASSES OF CONTAMINATED SOILS**

The Contractor and its LSP shall determine if soil excavated or soil to be excavated is unregulated soil or contaminated soil as defined in this section. Such materials shall be given a designation for purposes of reuse or disposal based on the criteria of the MCP. Soils and sediments which are not suitable for reuse will be given a designation for purposes of off-site disposal based on the characterization data and disposal facility license requirements. The Classes of Contaminated Soils are defined as follows:

**ITEMS 181.11 through 181.14** (Continued)

**UNREGULATED SOIL** consists of soil, fill and dredged material with measured levels of oil and hazardous material (OHM) contamination at concentrations below the applicable Reportable Concentrations (RCs) presented in the MCP. Unregulated soil consists of material which may be reused (or otherwise disposed) as fill within the Commonwealth of Massachusetts subject to the non-degradation criteria of the MCP (310 CMR 40.0032(3), in a restricted manner, such that they are sent to a location with equal or higher concentrations of similar contaminants. Disposal areas include licensed disposal facilities, approved industrial settings in areas which will be capped or covered with pavement or loamed and seeded, and for purposes of this project should be reused as fill within the project site construction corridor whenever possible. The material cannot be placed in residential and/or environmentally sensitive (e.g. wetlands) areas. Under no circumstances shall contaminated soils be placed in an uncontaminated or less contaminated area (including the area above the groundwater table if this area shows no sign of contamination).

The Contractor shall submit to MassDOT the proposed disposal location for unregulated soils for approval. If such a disposal location is not a licensed disposal facility, the Contractor shall submit to the Engineer analytical data to characterize the disposal area sufficiently to verify that the unregulated material generated within the MassDOT construction project limits is equal to or less than the contaminant levels at the disposal site and meets the non-degradation requirements of the MCP. In addition, the Contractor shall provide written confirmation from the owner of the proposed disposal location that they have been provided with the analytical data for both the materials to be disposed as well as the disposal site characterization and that s/he agrees to accept this material. A Material Shipping Record or Bill of Lading, as appropriate, shall be used to track the off-site disposal of unregulated soil and a copy, signed by the disposal facility or property owner, shall be provided to the Engineer in order to document legal disposal of the unregulated material.

The cost of on-site disposal of unregulated soil within the project area will be considered incidental to the item of work to which it pertains.

---

**ITEMS 181.11 through 181.14** (Continued)

**REGULATED SOIL** consists of materials containing measurable levels of OHM that are equal to or exceed the applicable Reportable Concentrations for the site as defined by the MCP, 310 CMR 40.0000. Regulated soil which meets the MCP reuse criteria of the applicable soil/groundwater category for this project area may be reused on site provided that it meets the appropriate geotechnical criteria established by the Engineer. Regulated Soil may be reused (as daily or intermediate cover or pre-cap contouring material) or disposed (as buried waste) at lined landfills within the Commonwealth of Massachusetts or at an unlined landfill that is approved by the Massachusetts Department of Environmental Protection (DEP) for accepting such material, in accordance with DEP Policy #COMM-97-001, or at a similar out-of-state facility. It should be noted that soils which exceed the levels and criteria for disposal at in-state landfills, as outlined in COMM-97-001, may be shipped to an in-state landfill, but require approval from the DEP Division of Solid Waste Management and receiving facility. An additional management alternative for this material is recycling into asphalt. Regulated Soils may also be recycled at a DEP approved recycling facility possessing a Class A recycling permit subject to acceptance by the facility and compliance with DEP Policy #BWSC-94-400. Regulated Soil removed from the site for disposal or treatment must be removed via an LSP approved Bill of Lading, Manifest or applicable material tracking form. This type of facility shall be approved/permitted by the State in which it operates to accept the class of contaminated soil in accordance with all applicable local, state and federal regulations.

**HAZARDOUS WASTE** consists of materials which must be disposed of at a facility permitted and operated in full compliance with Federal Regulation 40 CFR 260-265, Massachusetts Regulation 310 CMR 30.000, Toxic Substances Control Act (TSCA) regulations, or the equivalent regulations of other states, and all other applicable local, state, and federal regulations. All excavated materials classified as hazardous waste shall be disposed of at an out-of-state permitted facility. This facility shall be a RCRA hazardous waste or TSCA facility, or RCRA hazardous waste incinerator. This type of facility shall be approved/permitted by the State in which it operates to accept hazardous waste in accordance with all applicable local, state and federal regulations and shall be permitted to accept all contamination which may be present in the soil excavate. The Contractor shall ensure that, when needed, the facility can accept TSCA waste materials i.e. polychlorinated biphenyls (PCBs). Hazardous waste must be removed from the site for disposal or treatment via an LSP approved Manifest.

**MONITORING/SAMPLING/TESTING REQUIREMENTS**

The Contractor shall be responsible for monitoring, sampling and testing during and following excavation of contaminated soils to determine the specific class of contaminated material. Monitoring, sampling and testing frequency and techniques should be performed in accordance with Item 180.03 – LSP Services. Additional sampling and analysis may be necessary to meet the requirements of the disposal facility license. The cost of such additional sampling and analysis shall be included in the bid cost for the applicable disposal items. The Contractor shall obtain sufficient information to demonstrate that the contaminated soil meets the disposal criteria set by the receiving facility that will accept the material.

**ITEMS 181.11 through 181.14** (Continued)

No excavated material will be permanently placed on-site or removed for off-site disposal until the results of chemical analyses have been received and the materials have been properly classified. The Contractor shall submit to the Engineer results of field and laboratory chemical analyses tests within seven days after their completion, accompanied by the classification of the material determined by the Contractor, and the intended disposition of the material. The Contractor shall submit to the Engineer for review all plans and documents relevant to LSP services, including but not limited to, all documents that must be submitted to the DEP.

**WASTE TRACKING:**

Copies of the fully executed Weight Slips/Bills of Lading/ Manifests/Material Shipping Records or other material tracking form received by the Contractor from each disposal facility and for each load disposed of at that facility, shall be submitted to Engineer and the Contractor's LSP within three days of receipt by the Contractor. The Contractor is responsible for preparing and submitting such documents for review and signature by the LSP or other appropriate person with signatory authority, three days in advance of transporting soil off-site. The Contractor shall furnish a form attached to each manifest or other material tracking form for all material removed off-site, certifying that the material was delivered to the site approved for the class of material. If the proposed disposition of the material is for reuse within the project construction corridor, the Contractor shall cooperate with MassDOT to obtain a suitable representative sample(s) of the material to establish its structural characteristics in order to meet the applicable structural requirements as fill for the project.

All material transported off-site shall be loaded by the Contractor into properly licensed and permitted vehicles and transported directly to the selected disposal or recycling facility and be accompanied by the applicable shipping paper. At a minimum, truck bodies must be structurally sound with sealed tail gates, and trucks shall be lined and loads covered with a liner, which shall be placed to form a continuous waterproof tarpaulin to protect the load from wind and rain.

**DECONTAMINATION OF EQUIPMENT**

Tools and equipment which are to be taken from and reused off site shall be decontaminated in accordance with applicable local, state and federal regulations. This requirement shall include, but not be limited to, all tools, heavy machinery and excavating and hauling equipment used during excavation, stockpiling and handling of contaminated material. Decontamination of equipment is considered incidental to the applicable excavation item.



---

**ITEMS 181.11 through 181.14** (Continued)**REGULATORY REQUIREMENTS**

The Contractor shall be responsible for adhering to regulations, specifications and recognized standard practices related to contaminated material handling during excavation and disposal activities. MassDOT shall not be responsible at any time for the Contractor's violation of pertinent State or Federal regulations or endangerment of laborers and others. The Contractor shall comply with all rules, regulations, laws, permits and ordinances of all authorities having jurisdiction including, but not limited to, Massachusetts DEP, the U.S. Environmental Protection Agency (EPA), Federal Department of Transportation (DOT), Massachusetts Water Resources Authority (MWRA), the Commonwealth of Massachusetts and other applicable local, state and federal agencies governing the disposal of contaminated soils.

All labor, materials, equipment and services necessary to make the work comply with such regulations shall be provided by the Contractor without additional cost to MassDOT. Whenever there is a conflict or overlap within the regulations, the most stringent provisions shall apply. The Contractor shall reimburse MassDOT for all costs it incurs, including penalties and/or for fines, as a result of the Contractor's failure to adhere to the regulations, specifications, recognized standard practices, etc., that relate to contaminated material handling, transportation and disposal.

**SUBMITTALS****I. Summary of Sampling Results, Classification of Material and Proposed Disposal Option.**

The following information, presented in tabular format, must be submitted to the Engineer for review and approval prior to any reuse on-site or disposal off-site. This requirement is on-going throughout the project duration. At least two weeks prior to the start of any excavation activity, the Contractor shall submit a tracking template to be used to present the information as stipulated below. Excavation will not begin until the format is acceptable to MassDOT.

Characterization Reports will be submitted for all soil, sediment, debris and groundwater characterized through the sampling and analysis program. Each report will include a site plan which identifies the sampling locations represented in the Report. The Construction Plan sheets may be used as a base plan to record this information.

The Sampling Results will be presented in tabular format. Each sample will be identified by appropriate identification matching the sample identification shown on the Chain of Custody Record. The sample must also be identified by location (e.g. grid number or stockpile number). For each sample, the following information must be listed: the classification (unregulated, regulated, etc.), proposed disposal option for the stockpile or unit of material represented, and all analytical results.

---

**ITEMS 181.11 through 181.14** (Continued)

Each Characterization Report will include the laboratory analytical report and Chain of Custody Record for the samples included in the Report.

**II. Stockpiling, Transport, and Disposal.**

At least two weeks prior to the start of any excavation activity, the Contractor shall submit, in writing, the following for review and shall not begin excavation activity until the entire submittal is acceptable to MassDOT.

**Excavation and Stockpiling Protocol:**

Provide a written description of the management protocols for performing excavation and stockpiling and/or direct loading for transport, referencing the locations and methods of excavating and stockpiling excavated material.

**Disposal and Recycling Facilities:**

1. Provide the name, address, applicable licenses and approved waste profile for disposal and/or recycling location(s) where contaminated soil will be disposed. Present information substantiating the suitability of proposed sites to receive classifications of materials intended to be disposed there, including the ability of the facility to accept anticipated volumes of material.
2. Provide a summary of the history of compliance actions for each disposal/recycling facility proposed to be used by the Contractor. The compliance history shall include a comprehensive list of any state or federal citations, notices of non-compliance, consent decrees or violations relative to the management of waste (including remediation waste) at the facility. Material should not be sent to facilities which are actively considered by the DEP, USEPA or other responsible agency to be in violation of federal, state or local hazardous waste or hazardous material regulations. MassDOT reserves the right to reject any facility on the basis of poor compliance history.

**Transportation:**

The name, address, applicable license and insurance certificates of the licensed hauler(s) and equipment and handling methods to be used in excavation, segregation, transport, disposal or recycling.

**III. Material Tracking and Analytical Documentation for Reuse/Disposal.**

The following documents are required for all excavation, reuse and disposal operations and shall be in the format described. At least two weeks prior to the start of any excavation or demolition activity, the Contractor shall submit the tracking templates required to present the information as stipulated below. Excavation or demolition will not begin until the format is acceptable to MassDOT.

**ITEMS 181.11 through 181.14** (Continued)

All soils, sediments and demolition debris must be tracked from the point of excavation to stockpiling to onsite treatment/processing operations to off-site disposal or onsite reuse as applicable.

**Demolition Debris:**

Demolition debris must be tracked if the debris is stockpiled at a location other than the point of origin or if treatment or material processing is conducted. Identification of locations will be based on the station-offset of the location. The tracking table will identify date and point of generation, any field screening such as PID or dust monitoring, visual observations/comments, quantity, and stockpile ID/processing operation location. For each unit of material tracked, the table will also track reuse of the material on-site, providing reuse date, location of reuse as defined by start and end station, width of reuse location by offset, the fill elevation range, quantity, and finish grade for said location. For demolition debris which is not reused on site, the table will also track disposal of the material as defined by disposal date, quantity and disposal facility. The table must provide a reference to any analytical data generated for the material.

**Soil/Sediment:**

Soil excavation will be identified based on the station-offset of the excavation location limits. The tracking table will identify date and point of generation, any field screening such as PID or dust monitoring, visual observations, quantity, and stockpile number/location. For each unit of material tracked, the table will also track reuse of the material on-site and disposal of the material off-site using the same categories identified for demolition debris above.

**METHOD OF MEASUREMENT AND BASIS OF PAYMENT**

Disposal of contaminated soil shall be measured for payment by the Ton of actual and verified weight of contaminated materials removed and disposed of. The quantities will be determined only by weight slips issued by and signed by the disposal facility. The most cost-effective, legal disposal method shall be used. The work of the LSP for disposal under all of these items shall be incidental to the work with no additional compensation.

ITEM 181.11 Measurement for Disposal of Unregulated Soil shall be under the Contract Unit Price by the weight, in tons, of contaminated materials removed from the site and transported to and disposed of at an approved location or licensed facility, and includes any and all costs for approvals, permits, fees and taxes, additional testing/characterization required by the facility beyond the standard disposal test set, decontamination procedures, transportation and disposal.

ITEM 181.12 Measurement for Disposal of Regulated Soil – In-State Facility shall be under the Contract Unit Price by the weight in tons of contaminated materials removed from the site and transported to and disposed of at an approved in-state facility, and includes any and all costs for approvals, permits, fees and taxes, testing/characterization required by the facility beyond the standard disposal test set, decontamination procedures, transportation and disposal.

**ITEMS 181.11 through 181.14** (Continued)

ITEM 181.13 Measurement for Disposal of Regulated Soil - Out-of-State Facility shall be under the Contract Unit Price by the weight in tons of contaminated materials removed from the site and transported to and disposed of at an approved out-of-state facility, and includes any and all costs for approvals, permits, fees and taxes, testing/characterization required by the facility beyond the standard disposal test set, decontamination procedures, transportation and disposal.

ITEM 181.14 Measurement for Disposal of Hazardous Waste shall be under the Contract Unit Price by the weight in tons of hazardous waste removed from the site and transported to and disposed of at the licensed hazardous waste facility, and includes any and all costs for approvals, permits, fees and taxes, testing/characterization required by the facility beyond the standard disposal test set, decontamination procedures, transportation and disposal.

**ITEM 182.1****INSPECTION AND TESTING FOR ASBESTOS****LUMP SUM**

The work shall include the inspection and testing of all existing utility pipes suspected of containing asbestos. The existing waterproofing membrane which covers the bridge deck is suspected to be an asbestos containing material. When any demolition is required to enable the inspection and testing of the suspected material it will be considered incidental to this item and the Contractor must perform all asbestos handling and testing in accordance with the regulations stated below.

Dust suppression in the form of light water sprays, foams, dust suppressants and calcium chloride will be implemented as required to control dust during any disturbance of asbestos suspected material. Intrusive activities shall be reduced or curtailed under high wind or heavy rain conditions, which as described in the Health and Safety Plan (HASP) may pose a safety hazard to the workers.

The Contractor shall employ the services of a Massachusetts licensed “Asbestos Inspector” to inspect the material to determine whether or not “Item 182.21 Removal of Asbestos” is required. Should the asbestos inspector determine laboratory testing is required, a state certified laboratory shall be used to perform all necessary tests.

**REGULATIONS**

U.S. Department of Labor, Occupational Safety and Health Administration, (OSHA) including but not limited to:

- 29 CFR 1910 Section 1001 and 29 CFR 1926 Section 58 Occupational exposure to Asbestos, Tremolite, Anthophyllite and Actinolite, Final Rule
- 29 CFR 1910 Section 134 Respiration Protection
- 29 CFR 1926 Construction Industry
- 29 CFR 1910 Section 2 Access to Employee Exposure and Medical Records
- 29 CFR 1910 Section 1200 Hazard Communication
- 29 CFR 1910 Section 145 Specifications for Accident Prevention Signs and Tags

U.S. Environmental Protection Agency, (EPA) including but not limited to:

- 40 CFR 762, CPTS 62044, FRL 2843-9, Federal Register Vol. 50 no.134, July 12, 1985 p.28530 – 28540 Asbestos Abatement Projects Rule
- 40 CFR 61 Subpart A Regulation for Asbestos
- 40 CFR 61 Subpart M (Revised Subpart B) national Emission Standard for Asbestos

U.S. Department of Transportation 49 CFR 172 and 173

Massachusetts Department of Labor Standards (DLS) including but not limited to:

- 454 CMR 28.00 The Removal, Containment, Maintenance, or Encapsulation of Asbestos

**ITEM 182.1** (Continued)

Massachusetts Department of Environmental Protection (DEP), including but not limited to (supplementing subsection 7.01):

- 310 CMR 7.15 U Asbestos, Section 7.09 Odor and Dust, Section 7.10 Noise, Section 7.15 Air Pollution Control Regulations
- 310 CMR 18.00 and 19.00 Solid Waste Regulations

Local Requirements including but not limited to those of Health Departments, Fire Departments and Inspection Service Departments.

Wherever there is a conflict or overlap of the above references, the most stringent provision shall apply.

**BASIS OF PAYMENT**

Item 182.1 will be paid for at the Contract unit price per Lump Sum, which price shall include all materials, tools, equipment, and labor to complete the inspecting and testing of the asbestos suspected material, as specified above.

All costs in the connection with the protection of general public, private property, and all costs associated with the proper inspecting and testing of the material shall be included in the price and no additional compensation will be allowed.

**ITEM 182.21****REMOVAL OF ASBESTOS****LUMP SUM**

The work shall include the removal and satisfactory disposal of existing asbestos. The Contractor's attention is directed to the fact that existing asbestos shall be inspected and tested prior to removal, to determine if special removal and disposal is required. The Contractor shall follow all the rules and regulations stated in Item 182.1, Inspection and Testing for Asbestos. If asbestos is present, the Contractor shall follow all the rules and regulations stated in the section "Removal and Disposal of Asbestos Containing Materials", under this item. The Contractor should notify and coordinate his/her efforts with the proper utility accordingly.

**REMOVAL AND DISPOSAL OF ASBESTOS CONTAINING MATERIALS**

This section specifies the requirements for handling and removal of asbestos containing material. The Contractor must perform all asbestos handling and removal work in accordance with these specifications and the following additional requirements.

U.S. Department of Labor, Occupational Safety and Health Administration, (OSHA) including but not limited to:

- 29 CFR 1910 Section 1001 and 29 CFR 1926 Section 58 Occupational exposure to Asbestos, Tremolite, Anthophyllite and Actinolite, Final Rule
- 29 CFR 1910 Section 134 Respiration Protection
- 29 CFR 1926 Construction Industry
- 29 CFR 1910 Section 2 Access to Employee Exposure and Medical Records
- 29 CFR 1910 Section 1200 Hazard Communication
- 29 CFR 1910 Section 145 Specifications for Accident Prevention Signs and Tags

U.S. Environmental Protection Agency, (EPA) including but not limited to:

- 40 CFR 762, CPTS 62044, FRL 2843-9, Federal Register Vol. 50 no.134, July 12, 1985 p.28530 – 28540 Asbestos Abatement Projects Rule
- 40 CFR 61 Subpart A Regulation for Asbestos
- 40 CFR 61 Subpart M (Revised Subpart B) national Emission Standard for Asbestos

U.S. Department of Transportation 49 CFR 172 and 173

Massachusetts Department of Labor Standards (DLS) including but not limited to:

- 454 CMR 28.00 The Removal, Containment, Maintenance, or Encapsulation of Asbestos

Massachusetts Department of Environmental Protection (DEP), including but not limited to (supplementing subsection 7.01):

- 310 CMR 7.15 U Asbestos, Section 7.09 Odor and Dust, Section 7.10 Noise, Section 7.15 Air Pollution Control Regulations
- 310 CMR 18.00 and 19.00 Solid Waste Regulations

**ITEM 182.21** (Continued)

Local Requirements including but not limited to those of Health Departments, Fire Departments and Inspection Service Departments.

Wherever there is a conflict or overlap of the above references, the most stringent provision shall apply.

All asbestos material shall be removed and properly disposed of by a contractor or subcontractor with a current Massachusetts Abatement Contractors License issued by the Department of Labor and Industries. Work shall be supervised by a competent person as required by OSHA in 29 CFR 1926 to ensure regulatory compliance. This person must have completed a course at an EPA Training Center or equivalent course in asbestos abatement procedures, have had a minimum of four years on-the-job training and meet any additional requirements set forth in 29 CFR 1926 for a Competent Person. This person must also be certified by the Commonwealth as an Asbestos Abatement Supervisor and Asbestos Abatement Project Designer as required by 453 CMR 6.00.

Asbestos removal work shall be coordinated with all other work under the contract and shall be completed prior to performing any activities which could disturb the asbestos material or produce airborne asbestos fibers.

Dust suppression in the form of light water sprays, foams, dust suppressants and calcium chloride will be implemented as required to control dusting during any disturbance of asbestos suspected material. Alternatively, intrusive activities may be reduced or curtailed under high wind or heavy rain conditions, which in the opinion of the Health and Safety Plan (HASP) may pose a safety hazard to the workers.

**NOTIFICATION AND PERMITS**

The Contractor shall prepare and formal pre-notification form at least ten (10) days prior to the start of asbestos removal work. This form must be submitted to the appropriate Regional Office of the Massachusetts Department of Environmental Protection and to the U.S. Environmental Protection Agency Region I Air and Hazardous Material Division. A copy of the Submitted forms must be provided to the Engineer and kept at the work site.

Prior to starting any work, the Contractor shall also obtain any required asbestos removal permit (s) from the city/town. A copy of the permit (s) must be provided to the Engineer and posted at the work site.

The Contractor shall also obtain and pay all other applicable asbestos waste transportation and disposal permits, licenses and fees.



**ITEM 182.21** (Continued)

**STANDARD OPERATING PROCEDURES**

The standard operating procedure shall ensure the following:

1. Proper site security including posting of warning signs and restricting access to prevent unauthorized entry into the work spaces.
2. Proper protective clothing and respiratory protection prior to entering the work spaces.
3. Safe work practices including provision for communications; exclusion of eating, drinking, smoking, or use of procedures or equipment that would in any way reduce the effectiveness of respiratory protections or other engineering controls.
4. Proper exit practices from the work space though the showering and decontamination facilities.
5. Removing asbestos containing material in ways that minimize release of fibers.
6. Packing, labeling, loading, transporting and disposing of contaminated material in a way that minimizes or prevents exposure and contamination.
7. Emergency evacuation of personnel, for medical or safety (fire and some) so that exposure will be minimized.
8. Safety from accidents in the work space, especially from electrical shocks, slippery surfaces and entanglements in loose hoses and equipment.
9. Provisions for effective supervision and OSHA specified personnel air monitoring for exposed during work.

**REQUIRED SUBMITTALS**

The Contractor shall submit to the Engineer the following listed items at least ten (10) calendar days prior to the start of asbestos work. No asbestos removal work activities shall commence until these items are reviewed by the Engineer, unless otherwise waived. Submittals shall be clearly labeled and in sufficient detail to enable the Engineer to form an opinion as to its conformity to the specifications.

1. Name, experience and DLS certification of proposed Supervisors and Foreman responsible for asbestos work.
2. Summary of workforce by disciplines and a notarized statement documenting that all proposed works, by name, have receive all required medical exams and have been properly trained and certified for asbestos removal work, respirator use and appropriate Massachusetts DLS, EPA and OSHA standards.

**ITEM 182.21** (Continued)

3. Notarized statement that workers are physically fit and able to wear and use the type of respiratory protection proposed for the project. Notarized certification signed by an officer of the abatement contracting firm that exposure measurements, medical surveillance and worker training records are being kept in conformance with 29 CFR 1926.
4. Written plan of actions and standard operation procedures to include: location and layout of decontamination areas; sequencing of asbestos work; detailed schedule of work activities by date and interface with other project activities which affect work performance; methods used to assure safety and security; worker protection and exposure monitoring; contingency and emergency evacuation procedures; detailed description of methods to be employed to control pollution; waste handling procedures.
5. Written respiratory protection program specifying level of protection intended for each operation required by the project and details of daily inspection and maintenance elements.
6. Copies of the U.S. EPA, State and local asbestos removal pre-notification forms. If applicable, lists and copies of all permits, licenses, or manifests which will be applied for and used.
7. Name, location and applicable approval certificates for primary and secondary landfill for disposal of asbestos-containing or asbestos contaminated waste. Name, address and license number of hauler permitted to transport waste. (Submit copies of completed manifests upon disposal).

The Contractor must provide copies of daily inspection and record logs upon request of the Engineer, at any time during project. This information will include but is not limited to work entry data, respirator inspections and maintenance, HEPA-exhaust inspection and maintenance and other work applicable activities or reports of accident or unusual events.

**BASIS OF PAYMENT**

The work will be paid for at the Contract lump sum price, which price shall include all labor, materials, equipment, and incidental costs required to complete the work.

Payment of fifty percent (50%) of the Contract price shall be made upon completion of work in Phase 1A to the satisfaction and approval of the Engineer. Payment of the remaining fifty percent (50%) of the Contract price shall be made upon the completion of the work in Phase 2A to the satisfaction and approval of the Engineer.

All costs in connection with the protection of the general public, private property and all costs associated with the proper disposal of the material removed shall be included in the price and no additional compensation will be allowed.

**ITEM 184.1**

**DISPOSAL OF TREATED WOOD PRODUCTS**

**TON**

The Work under this item shall include the transportation and disposal of all treated existing wood product as required by the Engineer.

The timber components of the existing structure are suspected to be treated with creosote, pentachlorophenol and/or CCA. This item shall include all costs for sampling, laboratory testing, loading, transportation and disposal of the treated wood. The Contractor is required to submit disposal manifests to the Engineer prior to the completion of the project. All aspects of this Item are to be completed in accordance with state and federal regulations.

**METHOD OF MEASUREMENT**

Item 184.1 will be measured for payment by the weight, in tons, of treated timber transported and accepted at a licensed disposal facility.

**BASIS OF PAYMENT**

Item 184.1 will be paid at the Contract unit price per ton, which price shall include all labor, tools, equipment, materials, testing, loading, transportation, approvals, permits, and incidental costs required to complete the work.

**ITEM 210.02**

**SANITARY SEWER MANHOLE REMOVED**

**EACH**

The work to be done under this Item shall include the removal and disposal of sanitary sewer manholes, as designated on the Contract Drawings, and filling the cavity of the removed sanitary sewer manholes.

**CONSTRUCTION METHODS**

The designated sanitary sewer manholes shall be removed completely. The cavity shall be completely filled with selected excavated materials placed in 6-inch layers and thoroughly compacted.

**METHOD OF MEASUREMENT**

Item 210.02 will be measured for payment by the each, complete unit removed and disposed, regardless of depth.

**BASIS OF PAYMENT**

Item 210.02 will be paid at the Contract unit price per each, which price shall include all labor, tools, materials, equipment, and incidental costs required to complete the work.

**ITEM 220.8****SANITARY STRUCTURE REMODELED****EACH**

The work under this Item shall conform to the relevant provisions of Subsections 201 and 220 of the Standard Specifications and the following:

All sanitary sewer work shall comply with City of Fitchburg standards.

The work consists of remodeling the structures to the proposed lines and grades as shown on the plans or as required by the Engineer.

The installation of manhole frame and cover will be paid under Item 222.3, Frame and Grate (or Cover) Municipal Standard.

**MATERIALS**

The Contractor shall field verify the existing material and condition of these structures prior to starting the work.

The materials shall conform to Subsection 201.40 of the Standard Specifications.

**CONSTRUCTION METHODS**

Structures are to be remodeled after the temporary sewer bypass is removed and before installation of the rotary feature. Brick and/or block masonry up to the bottom of the casting shall be in accordance with Subsection 201.62.

Backfilling around the structures shall be in accordance with Subsection 201.65 of the Standard Specifications or gravel borrow when excavated material is unsuitable thoroughly compacted with mechanical devices.

The concrete cone and collar around the casting shall be constructed using 4,000 psi,  $\frac{3}{4}$  inch, 610 lb cement concrete (High early strength) as prescribed in M4.02.00 and M4.02.01 in the Standard Specifications.

Any structure that is in the traveled way and is not to the point of being backfilled and the cone installed at the end of any work day shall be steel plated and backfilled with compacted gravel, level with the roadway. The plates, gravel, and re-excavation of the gravel to complete the structure shall be considered incidental with no further compensation.

**METHOD OF MEASUREMENT**

Item 220.8 will be measured for payment by the each unit remodeled, complete in place, regardless of depth.

**BASIS OF PAYMENT**

Item 220.8 will be paid at the Contract unit price per each, which price shall include all labor, materials, equipment, and incidental costs required to complete the work.

**ITEM 222.3**

**FRAME AND GRATE (OR COVER)**  
**MUNICIPAL STANDARD**

**EACH**

The work to be done under this Item shall conform to the relevant provisions of Subsections 201 and 220 of the Standard Specifications, City of Fitchburg Standards, and the following:

**MATERIALS**

Manhole covers shall be 30-inch diameter hole type acceptable to the City of Fitchburg. Refer to Document A00807 included herein for City Standards.

Manufacturer shall be listed on the MassDOT Qualified Construction Material List for Cast Iron Frame and Grate or Cover.

**METHOD OF MEASUREMENT**

Item 222.3 will be measured for payment by the each, for each municipal standard frame and grate (or cover) furnished and delivered to the site.

**BASIS OF PAYMENT**

Item 222.3 will be paid at the Contract unit price per each, which price shall include all labor, materials, equipment, and incidental costs required to complete the work.

**ITEM 230.9****SANITARY SEWER TEMPORARY BYPASS****LUMP SUM**

The work to be done under this Item shall consist of furnishing all required labor, materials, coordination, operation and maintenance, and equipment to satisfactorily design, install, protect, maintain, and remove a temporary bypass system of the gravity combined sewer which will be installed and attached to the temporary utility bridge. This includes excavation, trenching, and reconstruction of existing driveways as needed for the sewer bypass, and restoration of the original sanitary sewer. The temporary combined sewer bypass pumping operations may be suspended due to inclement weather and/or as required by the City of Fitchburg.

**MATERIALS****Pumps**

All pumps used shall be centrifugal, end suction, fully automatic self-priming units that do not require the use of foot-valves, diaphragm pumps, isolation valves or vacuum pumps in the priming system. The pumps may be electric or diesel powered. All pumps used must be constructed to allow dry running for long periods to accommodate the cyclical nature of bypass flows. The pumps shall not be hydraulic submersible type.

The Contractor shall provide the required stop/start controls for each pump. The Contractor shall include one stand-by pump system (including suction and discharge piping) of each size to be maintained on site. Additional back-up pumps shall be on-line, isolated from the primary system by a valve.

**Discharge Piping**

In order to prevent the accidental spillage of flows, all temporary discharge systems shall be constructed of rigid steel pipe with positive, restrained joints or butt-fused, high density polyethylene pipe. Aluminum "irrigation" type piping or glued PVC pipe will not be allowed under any circumstances. Discharge hoses will only be allowed in short sections and with specific permission of the Engineer.

**CONSTRUCTION METHODS****Submittals**

The Contractor or it's vendor shall submit to the Engineer, MassDOT and the City of Fitchburg evidence that it possesses the required expertise for the design and operation of the temporary sewer bypass pumping systems. The Contractor or it's vendor shall provide at least five references of project experience of similar size and complexity to the sewer bypass system work contained within this project. The sewer bypass system shall meet the requirements of all codes and regulatory agencies having jurisdiction.

The Contractor shall submit a detailed description of the proposed pumping system stamped by a Professional Engineer in the State of Massachusetts and submit it and the vendor's references.

**ITEM 230.9** (Continued)

The Contractor shall submit to the Engineer detailed plans and descriptions outlining all provisions and precautions to be taken by the Contractor regarding the handling of existing wastewater flows. This plan must be specific and complete, including such items as schedules, locations, elevations, capacities of equipment, materials and all other incidental work required and/or required to insure proper protection of the facilities, including protection of the access and bypass pumping locations from damage due to the discharge flows, and compliance with the requirements and permit conditions specified in these contract documents. No construction shall begin until all provisions and requirements have been reviewed by the Engineer.

The plan shall include but not be limited to the following: Staging areas for pumps; Flow diversion method and types of materials; Number, size, material, location and method of installation of suction piping; Number, size, material, method of installation and location of discharge piping; Bypass pump sizes, capacity, number of each size to be on site and the related power requirements; Calculations of static lift, friction losses, and flow velocity (pump curves showing pump operating range shall be submitted); Standby power generator size, location; Downstream discharge plan; Method of protecting suction and discharge areas from erosion and damage; Thrust and restraint block sizes and locations; Sections showing suction and discharge pipe depth, embedment, select backfill; Method of noise control for each pump and/or generator, with external dB valve; Any temporary pipe supports and anchoring required; Design plans and computation for access to bypass pumping locations indicated on the drawings; Calculations for selection of bypass pumping pipe size; Schedule for installation of and maintenance of bypass pumping lines; Plan indicating proposed location of bypass pumping lines.

**System Design Requirements**

Bypass pumping systems shall have sufficient capacity to pump peak flow. The Contractor shall provide all pipeline, plugs, pumps of adequate size to handle peak flow, and discharge piping to ensure that the total flow can be safely diverted around the area of work. Bypass pumping system will be required to operate 24 hours per day.

The Contractor shall have adequate standby power and pumping equipment available and ready for immediate operation and use in the event of an emergency or breakdown. One standby pump for each size pump utilized shall be installed at the mainline flow bypassing locations, ready for use in the event of primary pump failure.

Bypass pumping system shall be capable of bypassing the flow around the work area and of releasing any amount of flow up to full available flow into the work area as required for satisfactory performance of work.



---

**ITEM 230.9** (Continued)**System Performance Requirements**

It is essential for the protection of the public safety and private property that there be no interruption in the flow throughout the duration of the project. To this end, the Contractor shall provide, maintain and operate all temporary facilities such as dams, plugs, pumping equipment (both primary and back-up units as required), conduits, all required power, and all other labor and equipment required to intercept the wastewater flow before it reaches the point where it would interfere with his work, carry it past his work and return it to the existing sewers downstream of his work.

The design, installation and operation of the temporary pumping system shall be the Contractor's responsibility. The bypass system shall meet the requirements of all codes and regulatory agencies having jurisdiction.

The Contractor shall provide all required means to safely convey the flow past the work area. The Contractor will not be permitted to stop or impede the flows under any circumstances.

The Contractor shall maintain flow around the work area in a manner that will not cause surcharging or significant level variations in the existing pipe, and that will protect public and private property from damage and flooding.

The Contractor shall protect water resources, wetlands and other natural resources.

The Contractor shall be responsible to meet noise requirements (73dbA @ 30'). In addition, the Contractor shall meet the City Noise Ordinance. All diesel driven primary and standby pumps shall be sound attenuated. The use of Critical Silenced Canopy Pumps or acoustical Whisper Pac enclosures for sound attenuation is required.

**Sewage Flow Control**

The Contractor shall coordinate with the City of Fitchburg for bypass the flow around the sections of sewer pipe under the River Street Bridge and throughout the work zone as needed to perform the work. The Contractor shall construct temporary bypass pumping structures and may be required to provide adequate suction conduit. The bypass is to be installed on the proposed temporary utility bridge and protected from vehicle traffic by being placed in a shallow trench beneath anchored steel plates when placed within or across driveway and roadway locations.

Diverting or blocking of flows shall incorporate primary and secondary devices. A line plug shall be inserted into the sewer pipe upstream of the section to be bypassed. The plug shall be so designed that all or any portion of the sewage can be released. After the work has been completed and diversion or blocking is no longer needed for performance and acceptance or work, the primary and secondary devices shall be removed in a manner that permits the flow to slowly return to normal without surge, to prevent surcharging or causing other major disturbances downstream. The bypass shall be made by plugging an existing upstream manhole and pumping the sewage into a downstream manhole or adjacent system.

**ITEM 230.9** (Continued)

The Contractor shall exercise caution and comply with OSHA requirements when working in the presence of gases, combustible or oxygen-deficient atmospheres, and confined spaces. When pumping and bypassing is required, the Contractor shall supply the pumps, conduits, and other equipment to divert the flow of sewage around the sewer piping sections within the River Street Bridge work zone which could be affected by the proposed River Street Bridge work. The bypass system shall be of sufficient capacity to handle existing full pipe flow capacity within the sewer system to be bypassed times 1.25.

The Contractor shall also pay close attention to weather reports for potential precipitation events and coordinate with the City of Fitchburg regarding the operation of the temporary bypass system. The combined sewer bypass pumping shall cease prior to anticipated precipitation events or as required by the City of Fitchburg.

The Contractor will be responsible for furnishing the required labor and supervision to set up and operate the pumping and by-pass system. All bypass systems shall be approved by the Engineer and the City of Fitchburg Engineer. Approval of the bypass system by the Engineers shall in no way be construed as relieving the Contractor of any responsibility under this Contract as related to protection of the interests of MassDOT, the City of Fitchburg and the general public.

The Contractor shall perform leakage and pressure tests of the bypass pumping discharge piping using clean water prior to actual operation. The Engineer shall be given 24 hours notice prior to testing.

The Contractor shall inspect bypass pumping system every two hours to ensure that the system is working correctly. The Contractor shall insure that the temporary pumping system is properly maintained and a responsible operator shall be on hand at all times when pumps are operating. The Contractor shall designate an onsite responsible operator charged to be responsible for the system.

Spare parts for pumps and piping shall be kept on site as required. Adequate hoisting equipment for each pump and accessories shall be maintained on the site.

At the end of each working day, temporary tie-ins shall be made between the sewer pipe under the River Street Bridge and the existing system and the bypass plug removed, unless the temporary system is to remain in place as approved by the Engineers and /or the City of Fitchburg.

When flow in a sewer line is plugged, blocked, or bypassed, sufficient precautions must be taken to protect the sewer lines from damage that might result from sewer surcharging. Further, precautions must be taken to ensure that sewer flow control operations do not cause flooding or damage to public or private property being served by the sewers involved. The Contractor is responsible for locating any existing utilities in the area the Contractor selects to locate the bypass pipelines.

**ITEM 230.9** (Continued)

The Contractor shall locate his by pass pipelines to minimize any disturbance to existing utilities and shall obtain approval of the pipeline locations from MassDOT, the Engineer and the City of Fitchburg. All costs associated with relocating utilities and obtaining all approvals shall be paid by the Contractor.

During all bypass pumping operation, the Contractor shall protect the work area and all local utilities from damage inflicted by any equipment. The Contractor shall be responsible for all physical damage to public and private property caused by human or mechanical failure. Under no circumstances will the dumping of raw sewage on private property or in city streets be allowed.

Except as specifically permitted, the installation of the bypass pipelines is prohibited in all salt marsh/wetland and resource areas. The pipeline must be located off streets and sidewalks and on shoulders of the roads unless otherwise required on the plans and approved by MassDOT and the City of Fitchburg. When the bypass pipeline crosses local streets and private driveways, the Contractor must place the bypass pipelines in trenches and cover with temporary backfill and pavement and protected with steel plates. Upon completion of the bypass pumping operations, and after the receipt of written permission from MassDOT, the Engineer and the City of Fitchburg, the Contractor shall remove all the piping, restore all property to pre-construction conditions and restore all roadway, driveway and sidewalk pavements, curbing and striping. The Contractor is responsible for obtaining any and all approvals from the MassDOT and the City of Fitchburg for placement of the temporary pipeline within public ways.

**BASIS OF PAYMENT**

Item 230.9 will be paid at the Contract lump sum price, as specified above. All costs in connection with the protection of the general public, private property and all costs associated with the sanitary sewer temporary bypass installation, protection, maintenance, removal and restoration, including existing driveway and roadway excavation and trenching with anchored steel plate protection, and driveway and roadway reconstruction after bypass removal, shall be considered as included in the price.

The cost of materials, tools, equipment and labor is to be paid for by the lump sum for the complete coordination, installation, protection and maintenance of the sanitary sewer temporary bypass. All costs associated with flow control of sewerage for the pre- and post- construction inspections of the sewer pipes will be paid under Item 100.99 Television Inspection of Sewer Pipes.

No payment will be made for flow control of sewerage associated with repairing damage to existing sewer pipes or structures caused by the Contractor's activities.

**ITEM 373.10**

**10 INCH WATER PIPE INSULATION**

**FOOT**

The work to be done under this Item shall conform to the requirements of Subsection 301 of the Standard Specifications and the following:

The work includes the procurement and installation of pipe spacers at the abutments.

**MATERIALS**

The insulation shall consist of a urethane insulating material, aluminum jacket and stainless steel straps as specified in M9.11.4 in Division III of the Standard Specifications.

Pipe spacers shall consist of two-piece 14-gauge T-304 stainless steel assembly with stainless steel bolts. Assembly shall be restrained positioning type. A minimum of two spacers are required at each abutment with four runners at each spacer. The runners shall be an ultra high molecular weight polymer with a maximum coefficient of friction of 0.12. The assembly shell liner shall be 0.090-inch ribbed PVC with 85-90 durometer.

The pipe spacer assembly shall be manufactured by the following manufacturers or an approved equivalent:

- a. Garlock Sealing Technologies, 1666 Division Street, Palmyra, NY 14522 USA.  
Phone: 1-800-448-6688
- b. Cascade Waterworks Manufacturing Company, 1213 Badger Street, Yorkville, IL 60560. Phone: 1-800-426-4301
- c. Advance Products & Systems, LLC, 108 Asset Ave, Scott, LA 70583.  
Phone: 1-337-233-6116

**ITEM 485.001**                      **COBBLESTONE ROTARY FEATURE**                      **SQUARE FOOT**

The work to be done under this Item shall consist of constructing rotary features in accordance with the Contract Drawings and these specifications, and in close conformity with the lines and grades shown on the plans or established by the Engineer.

The rotary features consist of cobblestone pavers set on a concrete bed and a gravel base course, and bounded by granite curbs.

**MATERIALS**

Materials shall meet the requirements specified in the following Subsections of Division III Materials in the standard specifications and as follows:

|   |   |
|---|---|
| Cobblestone Pavers.....                       | Provided by City of Fitchburg (see Note 1)    |
| Mountable Granite Curb .....                  | M9.04.1, as modified by Note 2                |
| Polymeric Sand .....                          | See Note 3                                    |
| 4,000 psi, 1.5-inch, 565 Cement Concrete..... | M4.02.00                                      |
| Welded Wire Reinforcement .....               | M8.01.2                                       |
| Steel Reinforcing Bar Dowels .....            | M8.01.7                                       |
| Stainless Steel Shim Stack .....              | AISI Type 316                                 |
| 4,000 psi Non-Shrink Grout.....               | MassDOT Qualified Construction Materials List |
| Gravel Borrow .....                           | M1.03.0 Type b                                |
| Tack Coat .....                               | M3.03.0                                       |

Notes

1. The City of Fitchburg (City) has agreed to provide cobblestone pavers to the Contractor for this project. However, this is subject to availability at the time of construction. The Contractor shall include the price of the cobblestone pavers in his or her estimate for this item. The unit price for this item will remain the same regardless of whether the cobblestone pavers are sourced from the City or elsewhere. Alternate sources of cobblestone pavers shall receive prior approval from the City before being used on the project. The Contractor provided cobblestones shall be reclaimed matching the City provided cobblestones in size, texture, smoothness, wear, weathering, and colors.
  
2. Granite curb shall be 12 inch wide x 15 inch +/- high (except at the north approach slab) with the top edge beveled full width x 3 inch high, as indicated on the Contract Drawings. At the north approach slab, the curb will be 12 inch wide x 7.5 inch high with the top edge beveled full width x 3 inch high.
  
3. Polymeric jointing sand shall be high performance stabilizing sand for joints up to 2-inch wide, heavy duty formula for heavy traffic and shall be installed per manufacturer recommendations.

**CONSTRUCTION METHODS**

The rotary features shall be constructed as detailed on the plans. The granite curbs shall be vertically set in concrete based on the lines and grades as shown on the plans.

**ITEM 485.001** (Continued)

At the north approach slab, the following procedure shall be utilized:

1. Use shim stacks to vertically position the rotary feature curb on the approach slab. Use at least two (2) shim stacks per curb section.
2. Drill and grout steel reinforcing bar dowels in the approach slab as specified for Item 912.3 Drilled & Grouted #3 Dowels.
3. Once the vertical position of the granite curb is established, cut and adjust the height of the dowel bars so that a minimum of 4-inch of embedment into the granite curb is achieved.
4. Pre-bed with grout thickness slightly more than the shim stack prior to final setting of the granite curbs.
5. Pour concrete bed for cobblestone pavers between the granite curbs. The granite curbs shall be held in their position by other means until the concrete has set.
6. Place cobblestone pavers as detailed on the plans.

Spaces between cobblestones shall have polymeric sand placed between them, dampened, and cured as follows:

Using a broom, sweep polymeric jointing sand into the paver joints filling up to the cobblestone chamfers (shoulders). Compact sand into joint spaces as thoroughly as possible. Carefully remove any remaining sand from the cobblestone surface prior to dampening. Apply gentle fine mist to the filled joints flooding the faces of the cobblestones and allowing the water to run into the joints. Do not flood sand onto the cobblestone exposed surface. Repeat dampening at regular hourly intervals for the first few hours after placement. Avoid overwatering joints. Install and cure polymeric sand in accordance with manufacturer's recommended instructions.

Temperatures shall remain above 35 deg. F. for a minimum of 12 hours after application. Protect from rain for a minimum of 12 hours. Allow a minimum 48 hours prior to foot or vehicular traffic.

**METHOD OF MEASUREMENT**

Item 485.001 will be measured for payment by the square foot of cobblestone rotary feature, complete in place.

**BASIS OF PAYMENT**

Item 485.001 will be paid for at the Contract unit price per square foot, which price shall include all labor, materials, equipment, and incidental costs required to complete the work.

**ITEM 657.**  
**ITEM 657.5****TEMPORARY FENCE**  
**TEMPORARY FENCE REMOVED AND RESET****FOOT**  
**FOOT**

The work under these items shall conform to the relevant provisions of Subsections 644 and 665 of the Standard Specifications, and the following:

Work under these Items consists of erection, maintaining, and relocating temporary fence and gates during construction and removal from the project site.

For purposes of this specification, the term "fence" also includes temporary fences or screens mounted on temporary traffic barriers.

**MATERIALS**

Ground-mounted fence: Temporary fence shall be 12-foot wide by 6-foot tall chain link fence panels conforming to ASTM A392 mounted on 36"x16" panel stands. Fence and related hardware shall be galvanized steel.

The fence shall be chain link and shall meet the requirements of the Standard Specifications and the Construction Standards, except the material need not be in new condition. Gates shall be used at all locations that are to be opened on a regular basis.

Barrier-mounted fence: Use fence or screen system recommended by barrier manufacturer.

**CONSTRUCTION METHODS**

Erect temporary fencing, gates, and appurtenances as required to protect the work and the public. Refer to Division I, Section 7.00 of the Standard Specifications.

Set fence on panel stands placed on solid ground. Place panel stands such that they do not project into pedestrian paths. Brace fence or weigh down panel stands as needed to prevent overturning. Clamp adjacent fence panels together.

Temporary fence shall be installed on top of temporary traffic barriers as shown on the drawing and as needed to maintain a secure work site. Temporary fence mounted on traffic barriers shall be compatible with the barrier system selected. Mount fence on barriers per barrier manufacturer's recommendations.

Fence, connections and anchoring system shall be designed to sustain AASHTO wind loads applied on the fence, wind screen and barrier. Provide bracing, sand bags, or other approved method as needed to prevent fencing from overturning.

Erect fence on the ground using metal or concrete bases or on temporary barriers as appropriate for the temporary traffic control setup. Fence shall be set plumb and the bottom of the fence fabric shall be a nominal distance of three inches from the ground. Clear and level ground as needed to install fences.

**ITEMS 657. and 657.5 (Continued)**

Where a power line crosses a fence, ground the fence in accordance with the National Electric Safety Code.

Remove temporary fencing from the project site when required by the Engineer. Temporary fencing materials will remain the property of the Contractor.

**METHOD OF MEASUREMENT**

Temporary Fence will be measured for payment by the foot for the most length of fence used on site, including gates, at any one time.

Temporary Fence Removed and Reset will be measured by the foot for the total length of fence that is removed and reset between each construction stages, including gates.

**BASIS OF PAYMENT**

Item 657 - Temporary Fence will be paid for at the contract unit price per foot. This price shall constitute full compensation for all labor, materials, equipment, and all fence, gates, supports, bracing, hardware, and all incidental costs required to erect, maintain, disassemble, and remove temporary fencing. No payment will be made for fence that is delivered to the site but is not used during the course of the Project.

Item 657.5 - Temporary Fence Removed and Reset will be paid for at the contract unit price per foot. This price shall constitute full compensation for all labor, material, equipment, the removal, relocation, and resetting of temporary fencing, gates, supports, hardware, and other appurtenances between construction stages. No payment will be made for minor adjustments to temporary fence locations to accommodate the Contractor's daily activities during a given construction stage. Such minor adjustments will be considered incidental to the Contract.



**ITEM 697.1****SILT SACK****EACH**

Work under this item shall conform to the relevant provisions of Subsections 227 and 670 of the Standard Specifications and the following:

The work under this item includes the furnishing, installation, maintenance and removal of a reusable fabric sack to be installed in drainage structures for the protection of wetlands and other resource areas and the prevention of silt and sediment from the construction site from entering the storm water collection system. Devices shall be ACF Environmental (800)-448-3636; Reed & Graham, Inc. Geosynthetics (888)-381-0800; The BMP Store (800)-644-9223; or approved equal.

**CONSTRUCTION**

Silt sacks shall be installed in retained existing and proposed catch basins and drop inlets within the project limits and as required by the Resident Engineer.

The silt sack shall be as manufactured to fit the opening of the drainage structure under regular flow conditions, and shall be mounted under the grate. The insert shall be secured from the surface such that the grate can be removed without the insert discharging into the structure. The filter material shall be installed and maintained in accordance with the manufacturer's written literature and as directed by the Engineer.

Silt sacks shall remain in place until the placement of the pavement overlay or top course and the graded areas have become permanently stabilized by vegetative growth. All materials used for the filter fabric will become the property of the Contractor and shall be removed from the site.

The Contractor shall inspect the condition of silt sacks after each rainstorm and during major rain events. Silt sacks shall be cleaned periodically to remove and disposed of accumulated debris as required. Silt sacks, which become damaged during construction operations, shall be repaired or replaced immediately at no additional cost to the Department.

When emptying the silt sack, the contractor shall take all due care to prevent sediment from entering the structure. Any silt or other debris found in the drainage system at the end of construction shall be removed at the Contractors expense. The silt and sediment from the silt sack shall be legally disposed of offsite. Under no condition shall silt and sediment from the insert be deposited on site and used in construction.

All curb openings shall be blocked to prevent stormwater from bypassing the device.

All debris accumulated in silt sacks shall be handled and disposed of as specified in Subsection 227 of the Standard Specifications.

**ITEM 697.1** (Continued)

**METHOD OF MEASUREMENT AND BASIS OF PAYMENT**

Silt sacks will be measured and paid at the Contract unit price per each, complete in place, which price shall include all labor, materials, equipment and incidental costs required to complete the work. No separate payment will be made for removal and disposal of the sediment from the insert, but all costs in connection therewith shall be included in the Contract unit price bid.

**ITEM 740. ENGINEERS FIELD OFFICE AND EQUIPMENT (TYPE A) MONTH**

The work under this Item shall conform to the relevant provisions of Subsection 740 of the Standard Specifications and the following:

Two computer systems and printer system meeting minimum requirements set forth below including installation, maintenance, power, paper, disks, and other supplies shall be provided at the Resident Engineer's Office:

All equipment shall be UL approved and Energy Star compliant.

The Computer System shall meet the following minimum criteria or better:

|                      |   |
|----------------------|---|
| Processor:           | Intel, 3.5 GHz  |
| System Memory (RAM): | 12 GB   |
| Hard Drive:          | 500 GB  |
| Optical Drive:       | DVD-RW/DVD+RW/CD-RW/CD+RW   |
| Graphics Card:       | 8 GB  |
| Network Adapter:     | 10/100 Mbit/s   |
| USB Ports:           | 6 USB 3.0 ports   |
| Keyboard:            | Generic   |
| Mouse:               | Optical mouse with scroll, MS-Mouse compliant   |
| Video/Audio          | the computer system shall be capable of allow video calling and recording:  |
| Video camera         | shall be High Definition 1080p widescreen capable video calling and recording with built in microphone. The microphone system shall capture natural audio while filtering out background noise.   |
| Audio                | shall be stereo multimedia speaker system delivering premium sound.   |
| OS:                  | Latest Windows Professional with all security updates   |
| Web Browser:         | Latest Internet Explorer with all security updates  |
| Applications:        | Latest MS Office Professional with all security updates<br>Latest Adobe Acrobat Professional with all security updates<br>Latest Autodesk AutoCAD LT<br>Antivirus software with all current security updates maintained through the life of the contract. |
| Monitors:            | Two 27" LED with Full HD resolution.<br>Max. resolution 1920 x 1080   |
| Flash drives:        | 2 (two) - 128GB USB 3.0   |
| Internet access:     | High Speed (min. 24 mbps) internet access with wireless router.   |

**ITEM 740.** (Continued)

The Multifunction Printer System shall meet the following minimum criteria or better:

Color laser printer, fax, scanner, email and copier all in one with the following minimum capabilities:

- Estimated volume 8,000 pages per month
- LCD touch panel display
- 50 page reversing automatic document feeder
- Reduction/enlargement capability
- Ability to copy and print 11" x 17" paper size
- email and network pc connectivity
- Microsoft and Apple compatibility
- ability to overwrite latent images on hard drive
- 600 x 600 dpi capability
- 30 pages per minute print speed (color),
- 4 Paper Trays Standard (RADF) (not including the bypass tray)
- Automatic duplexing
- Finisher with staple functions
- Standard Ethernet. Print Controller
- Scan documents to PDF, PC and USB
- ability to print with authenticated access protection

The Contractor shall supply a maintenance contract for next day service, and all supplies (toner, staples, paper) necessary to meet estimated monthly usage.

The Engineer's Field Office and the equipment included herein including the computer system, and printer shall remain the property of the Contractor at the completion of the project. Disks, flash drives, and card readers with cards shall become the property of the Department.

Compensation for this work will be made at the contract unit price per month which price includes full compensation for all services and equipment, and incidentals necessary to provide equipment, maintenance, insurance as specified and as directed by the Engineer.

**ITEM 748.2****PRE-CONSTRUCTION SURVEY****LUMP SUM**

The work under this Item shall consist of performing pre-construction photographic and video surveys in and around the project area. Surveys will be repeated at the completion of the work where damage claims have been reported.

The Contractor shall document pre-construction conditions on all exterior surface features and building exteriors that could be affected by the work.

**CONSTRUCTION METHODS**

The company performing the photography and videography shall have experience documenting at least five construction projects of similar size and scope.

Surveys of buildings (exterior) shall be performed under the direction of a Registered Professional Engineer licensed in the Commonwealth of Massachusetts with at least three years of experience in the design and/or inspection of residential and commercial structures.

The Contractor shall perform the exterior survey for the entire project area before beginning any construction work.

Perform and document with photos and video a detailed visual examination of above-grade structures, buildings, and outside areas, including site improvements and plantings. Take color photographs showing any structural faults, including but not limited to:

1. Cracks in structures
2. Cracked or missing plaster
3. Damaged masonry or roofing
4. Damaged windows or doorways
5. Walls or fences that are out of plumb
6. Damage to foundations
7. Damage to sidewalks, paved areas, utility poles, stairways, patios, retaining walls, and landscaped areas.

All photos and videos shall contain a relative dimension reference that is easily recognizable for scale. In views where dimensions are critical, use a recognizable measuring device such as a folding ruler or measuring tape in close relationship to the subject of the image and in a manner that the markings are clearly visible.

**ITEM 748.2** (Continued)

Photos shall be tabulated in a log that lists:

1. Project name and contract number.
2. Photo file name
3. Property address
4. Date of photo
5. Weather conditions
6. Photograph identification
  - a. View/orientation of the photograph (e.g. compass direction and angle of view)
  - b. Description of contents with any notable features observed
  - c. Other data pertinent to the purpose and identification of the photo

**SUBMITTALS**

Within 30 days of Notice to Proceed, but before performing any photography or videography work, the Contractor shall submit the qualifications of the Professional Engineer(s) and the photographer/ videographer performing the surveys.

The Contractor shall submit written release(s) from the photographers and videographers covering all photos (print and digital) and videos made for the project.

The Contractor shall submit a copy of pre-construction surveys on CD, DVD, or USB drive, as approved by the Engineer. Photos and videos shall be organized into folders by building address. Provide up to four hard copies of logs if requested by the Engineer.

**BASIS OF PAYMENT**

Item 748.2 will be paid for at the Contract lump sum price, which price shall include all the labor, materials, equipment, and incidental costs required to complete the work.

**ITEM 756.****NPDES STORMWATER POLLUTION  
PREVENTION PLAN****LUMP SUM**

This Item addresses the preparation and implementation of a Storm Water Pollution Prevention Plan required by the National Pollutant Discharge Elimination System (NPDES) and applicable Construction General Permit (CGP) issued by the U.S. Environmental Protection Agency (EPA).

Pursuant to the Federal Clean Water Act, construction activities which disturb one acre or more are required to apply to the EPA for coverage under the NPDES General Permit for Storm Water Discharges from Construction Activities. The Contractor shall be fully responsible for compliance with the most recently issued CGP and any subsequent revisions. Should a fine or penalty be assessed against it, or MassDOT, as a result of a local, state, or federal enforcement action due to non-compliance with the CGP, the Contractor shall take full responsibility.

The NPDES CGP requires the submission of a Notice of Intent (NOI) to the EPA prior to the start of construction (defined as any activity which disturbs land, including clearing and grubbing). There is a fourteen (14) day review period commencing from the date on which EPA enters the Notice into their database. Based on the review of the NOI, EPA may require additional information, including but not limited to, the submission of the Storm Water Pollution Prevention Plan (SWPPP) for review. Work may not commence on the project until final authorization has been granted by EPA. Any additional time required by EPA for review of submittals will not constitute a basis for claim of delay.

In addition, if the project discharges to an Outstanding Resource Water, vernal pool, or is within a coastal ACEC as identified by the Massachusetts Department of Environmental Protection (DEP), a separate notification to DEP is required. DEP may also require submission of the Storm Water Pollution Prevention Plan for review and approval. Filing fees associated with the notification to DEP and, if required, the SWPPP filing to DEP shall be paid by the Contractor.

The CGP also requires the preparation and implementation of a SWPPP in accordance with the afore-mentioned statutes and regulations. The Plan will include the CGP conditions and detailed descriptions of controls of erosion and sedimentation to be implemented during construction. The contractor shall prepare the SWPPP and update it as necessary. The Contractor shall submit the Plan to the Engineer for approval at least four (4) weeks prior to any site activities. It is the responsibility of the Contractor to comply with the CGP conditions and the conditions of any state Wetlands Protection Act Order, Water Quality Certification, Corps of Engineers Section 404 Permit and other environmental permits applicable to the project and to include in the SWPPP the methods and means necessary to comply with applicable conditions of said permits.

**ITEM 756.** (Continued)

It is the responsibility of the Contractor to complete the SWPPP in accordance with the EPA CGP, provide all information required, and obtain any and all certifications as required by the CGP. Any amendments to the SWPPP required by site conditions, schedule changes, revised work, regulations, construction methodologies, and the like are the responsibility of the Contractor. Amendments will require the approval of the Engineer prior to implementation.

In addition to the CGP requirements for inspections, MassDOT requires inspection of all erosion controls and site conditions on a weekly basis. Inspections are also required at portions of sites that discharge to sediment or nutrient impaired or high quality waters per the CGP when each incidence of rainfall exceeding 0.25 inches in twenty-four hours or after snowmelt discharge from a storm event that produces 3.25 inches or more of snow within twenty-four hours occurs. The CGP requires that inspections be performed by a qualified individual as outlined in the CGP. MassDOT requires proof of completion of a 4 hour minimum sedimentation and erosion control training class current to the latest CGP. This individual can be, but not limited to, someone that is either a certified inspector, certified professional, or certified storm water inspector. The documentation shall be included as an appendix in the SWPPP. The inspector's qualifications shall be submitted to the Engineer for approval prior to beginning any work. This individual shall be on-site during construction to perform these inspections. In addition, if the Engineer determines at any time that the inspector's performance is inadequate, the Contractor shall provide an alternate inspector. Written weekly inspection forms, storm event inspection forms, and Monthly Summary Reports must be completed and provided to the Engineer. Monthly Summary Reports must include a summary of construction activities undertaken during the reporting period, general site conditions, erosion control maintenance and corrective actions taken, the anticipated schedule of construction activities for the next reporting period, any SWPPP amendments, and representative photographs.

The Contractor is responsible for preparation of the Plan, all SWPPP certifications, inspections, reports and any and all corrective actions necessary to comply with the provisions of the CGP. The Standard Specifications require adequate erosion control for the duration of the Contract. All control measures must be properly selected, installed, and maintained in accordance with manufacturer specifications and good engineering practices. If periodic inspections or other information indicates a control has been used inappropriately or is no longer adequate, it is the responsibility of the Contractor to replace or modify the control for site conditions at no additional cost to the Department. Contractor must maintain all control measures and other protective measures in effective operating conditions and shall consider replacement of erosion controls for each construction season.

This Item addresses acceptable completion of the SWPPP, any revisions/amendments required during construction, and preparation of monthly reports. In addition, any erosion controls beyond those specified in bid items which are selected by the Contractor to facilitate and/or address the Contractor's schedule, methods and prosecution of the work shall be considered incidental to this item.



**ITEM 756.** (Continued)

The CGP provides specific requirements for temporary and final stabilization. This shall be incorporated into the project schedule. The permit defines specific deadline requirements for Initial Stabilization (“immediately”, i.e., no later than the end of the next work day following the day when earth-disturbing activities have temporarily or permanently ceased) and for Complete Stabilization Activities (no later than 14 calendar days after the initiation of stabilization). Stabilization criteria for vegetative and non-vegetative measures are provided in the CGP.

The CGP requires the submission of a Notice of Termination (NOT) from all operators when final stabilization has been achieved, as well as removal and proper disposal of all construction materials, waste and waste handling devices, removal of all equipment and construction vehicles, removal of all temporary stormwater controls, etc. Approval of final stabilization by the Engineer and confirmation of submission of the NOT will be required prior to submission of the Resident Engineer’s Final Estimate. The permittee shall use EPA’s website to prepare and submit the NOT.

**BASIS OF PAYMENT**

Payment for all work under this Item shall be made at the contract unit price, lump sum, which shall include all work detailed above, including Plan preparation, required revisions, revisions/addenda during construction, monthly reports and filing fees.

Payment of fifty (50) % of the contract price shall be made upon acceptance of the NPDES Stormwater Pollution Prevention plan. Payment of forty (40) % of the contract price shall be made in equal installments over the expected duration of stormwater pollution prevention measures. Payment of the final ten (10) % of the contract price shall be paid upon satisfactory submission of a Notice of termination (NOT) when final stabilization has been achieved.

**ITEM 767.121****SEDIMENT CONTROL BARRIER****FOOT**

The work under this item shall conform to the relevant provisions of Subsections 670, 751, and 767 of the Standard Specifications and shall include the furnishing and placement of a sediment control barrier. Sediment control barrier shall be installed prior to disturbing upslope soil.

The purpose of the sediment control barrier is to slow runoff velocity and filter suspended sediments from storm water flow. Sediment barrier may be used to contain stockpile sediments, to break slope length, and to slow or prevent upgradient water or water off road surfaces from flowing into a work zone. The Contractor shall be responsible for ensuring that barriers fulfill the intent of adequately controlling siltation and runoff.

Twelve-inch diameter (after installation) compost filter tubes with biodegradable natural fabric (i.e., cotton, jute, burlap) are intended to be the primary sedimentation control barrier. Photo-biodegradable fabric shall not be used.

For small areas of disturbance with minimal slope and slope length, the Engineer may approve the following sediment control methods:

- 9-inch compost filter tubes
- Straw bales which shall be trenched

No straw wattles may be used. Additional compost filter tubes (adding depth or height) shall be used at specific locations of concentrated flow such as at gully points, steep slopes, or identified failure points in the sediment capture line.

When required by permits, additional sediment barrier shall be stored on-site for emergency use and replacement for the duration of the contract.

Where shown on the plans or when required by permits, sedimentation fence shall be used in addition to compost filter tubes and straw bales and shall be compensated under that item.

Sediment control barriers shall be installed in the approximate location as shown on the plans and as required so that no excavated or disturbed soil can enter mitigation areas or adjacent wetlands or waterways. If necessary to accommodate field conditions and to maximize effectiveness, barrier locations may be shifted with approval from the Engineer. Barriers shall be in place prior to excavation work. No work shall take place outside the barriers.

**MATERIALS AND CONSTRUCTION**

Prior to initial placement of barriers, the Contractor and the Engineer shall review locations specified on the plans and adjust placement to ensure that the placement will provide maximum effectiveness.

Barriers shall be staked, trenched, and/or wedged as specified herein and according to the Manufacturer's instructions. Barriers shall be securely in contact with existing soil such that there is no flow beneath the barrier.

---

**ITEM 767.121** (Continued)**Compost Filter Tube**

Compost material inside the filter tube shall meet M1.06.0, except for the following: no peat, manure or bio-solids shall be used; no kiln-dried wood or construction debris shall be allowed; material shall pass through a 2-inch sieve; and the C:N ratio shall be disregarded.

Outer tube fabric shall be made of 100% biodegradable materials (i.e., cotton, hemp or jute) and shall have a knitted mesh with openings that allow for sufficient water flow and effective sediment capture.

Tubes shall be tamped, but not trenched, to ensure good contact with soil. When reinforcement is necessary, tubes shall be stacked as shown on the detail plans.

**Straw Bales**

Straw bales shall be used if shown on the plans or when specified by Orders of Condition or other permit requirements.

Bales should be placed in a single row, lengthwise on the contour, with ends of adjacent bales tightly abutting one another. All bales should be either wire-bound or string-tied. Straw bales should be installed so that bindings are oriented around the sides (rather than along the tops and bottoms) of the bales in order to prevent deterioration of the bindings.

The barrier should be entrenched and backfilled. A trench should be excavated the width of a bale and the length of the proposed barrier to a minimum depth of 4 inches. The trench must be deep enough to remove all grass and other material which might allow underflow. After the bales are staked and chinked (filled by wedging), the excavated soil should be backfilled against the barrier. Backfill soil should conform to the ground level on the downhill side and should be built up to 4 inches against the uphill side of the barrier.

Each bale should be securely anchored by at least 2 stakes or re-bars driven through the bale. The first stake in each bale should be driven toward the previously laid bale to force the bales together. Stakes or re-bars should be driven deep enough into the ground to securely anchor the bales. For safety reasons, stakes should not extend above the bales but should be driven in flush with the top of the bale.

The gaps between the bales should be chinked (filled by wedging) with straw to prevent water from escaping between the bales. Loose straw scattered over the area immediately uphill from a straw bale barrier tends to increase barrier efficiency. Wedging must be done carefully in order not to separate the bales.

When used in a swale, the barrier should be extended to such a length that the bottoms of the end bales are higher in elevation than the top of the lowest middle bale to assure that sediment-laden runoff will flow either through or over the barrier but not around it.

---

**ITEM 767.121** (Continued)**Sedimentation Fence**

Materials and Installation shall be per Subsection 670.40 and 670.60 of the Standard Specifications and the following:

Sedimentation fence shall only be used if shown on the plans or when specified by Orders of Condition or other permit requirements.

When used with compost filter tubes, the tube shall be placed on a minimum of 8 inches of folded fabric on the upslope side of the fence. Fabric does not need to be trenched.

When used with straw bales, an 8-inch deep and 4-inch wide trench or V-trench shall be dug on the upslope side of the fence line. One foot of fabric shall be placed in the bottom of the trench followed by backfilling with compacted earth or gravel. Stakes shall be on the down slope side of the trench and shall be spaced such that the fence remains vertical and effective.

Width of fabric shall be sufficient to provide a 36-inch high barrier after fabric is folded or trenched. Sagging fabric will require additional staking or other anchoring.

**MAINTENANCE**

Maintenance of the sediment control barrier shall be per Subsection 670.60 of the Standard Specifications or per the Stormwater Pollution Prevention Plan (SWPPP), whichever is more restrictive.

The Contractor shall inspect the sediment barrier in accordance with relevant permits. At a minimum, barriers shall be inspected at least once every 7 calendar days and after a rain event resulting in 0.25-inch or more of rainfall. Contractor shall be responsible for ensuring that an effective barrier is in place and working effectively for all phases of the Contract.

Barriers that decompose such that they no longer provide the function required shall be repaired or replaced as directed. If the resulting berm of compost within the fabric tube is sufficiently intact (despite fabric decay) and continues to provide effective water and sediment control, barrier does not necessarily require replacement.

**DISMANTLING & REMOVING**

Barriers shall be dismantled and/or removed, as required, when construction work is complete and upslope areas have been permanently stabilized and after receiving permission to do so from the Engineer.

Regardless of site context, nonbiodegradable material and components of the sediment barriers, including photo-biodegradable fabric, plastic netting, nylon twine, and sedimentation fence, shall be removed and disposed off-site by the Contractor.

**ITEM 767.121** (Continued)

For naturalized areas, biodegradable, natural fabric and material may be left in place to decompose on-site. In urban, residential, or other locations where aesthetics is a concern, the following shall apply:

- Compost filter tube fabric shall be cut and removed, and compost shall be raked to blend evenly (as would be done with a soil amendment or mulch). No more than a 2-inch depth shall be left on soil substrate.
- Straw bales shall be removed and disposed off-site by the Contractor. Areas of trenching shall be raked smooth and disturbed soils stabilized with a seed mix matching adjacent seeding or existing grasses (i.e., lawn or native grass mix).
- Sedimentation fence, stakes, and other debris shall be removed and disposed off-site. Site shall be restored to a neat and clean condition.

**METHOD OF MEASUREMENT AND BASIS OF PAYMENT**

Item 767.121 will be measured and paid for at the Contract unit price per foot of sediment control barrier which price shall include all labor, equipment, materials, maintenance, dismantling, removal, restoration of soil, and all incidental costs required to complete the work.

Additional barrier, such as double or triple stacking of compost filter tubes, will be paid for per foot of tube installed.

Barriers that have been driven over or otherwise damaged by construction activities shall be repaired or replaced as directed by the Engineer at the Contractor's expense.

**ITEM 812.13**  
**ITEM 812.30**

**LIGHT STANDARD FOUNDATION SD3.013**  
**STANDARD SIGNAL POST FOUNDATION SD3.030**

**EACH**  
**EACH**

The work to be done under these items shall conform to the relevant provisions of Subsections 801 of the Standard Specifications and the following:

The work shall also include a field verification of existing anchor bolt layout and anchor bolt diameter in the foundation base.

**MATERIALS**

Anchor bolts, nuts, and washers shall conform to M8.01.5: Anchor Bolts, Nuts and Washers.

**CONSTRUCTION METHODS**

The Contractor shall take precaution while excavating around the foundation so as not to damage existing conduits and wiring. The Contractor shall take detailed measurements of the existing anchor bolt layout and diameter. The anchor bolt embedment shall be taken as 8 inches less than the depth of the foundation. The anchor bolt circle diameter and layout shall be maintained by use of templates at the top and bottom of the anchor bolts, and shall be cast-in with the foundation.

**ITEM 859.1**      **REFLECTORIZED DRUMS WITH SEQUENTIAL**      **DAY**  
**FLASHING WARNING LIGHTS**

The work under this Item shall conform the relevant provisions of Subsection 850 of the Standard Specifications and the following:

Work under this item consists of furnishing, installing, maintaining in proper operating conditions, and removing reflectorized drums, and any necessary ballast, equipped with sequential flashing warning lights.

**MATERIALS**

Reflectorized drums shall be listed on the MassDOT Qualified Traffic Control Equipment List. Reflective sheeting on drums shall meet or exceed ASTM D4956 Type VIII. All drums shall be maintained in a satisfactory manner including the removal of oils, dirt, and debris that may cause reduced retroreflectivity.

The Contractor shall use one of the following sequential flashing warning light systems unless otherwise approved by the Engineer:

1. Empco-Lite LWCS D.
2. pi-Lit® Sequential Barricade-Style Lamp; or
3. Unipart Dorman SynchroGUIDE.

Sequential flashing warning lights shall be secured to reflectorized drums per the light manufacturer's specifications.

**CONSTRUCTION METHODS**

The first ten (10) drums in any merging or shifting taper as designated in the Temporary Traffic Control Plan shall be equipped with sequential flashing warning lights. These lights shall be operating, at a minimum, between dusk and dawn when the taper is deployed.

The successive flashing of the sequential warning lights shall occur from the upstream end of the merging or shifting taper to the downstream end of the taper in order to identify the desired vehicle path. Each warning light in the sequence shall be flashed at a rate of not less than 55, nor more than 75 times per minute.

Warning lights shall be powered off when drums are not deployed in a taper.

**ITEM 859.1** (Continued)

**METHOD OF MEASUREMENT**

A group of ten (10) reflectorized drums with sequential flashing warning lights is considered one (1) unit and will be measured by the day. Each period of up to 24 hours during which this unit is in use will be measured as one day regardless of the number of times that the drums are positioned, repositioned, removed, or returned to service.

**BASIS OF PAYMENT**

Reflectorized Drums with Sequential Flashing Warning Lights will be paid for at the contract unit price per day, which shall include full compensation for furnishing, positioning, repositioning, and removing the group of ten (10) drums as directed by the Engineer.



**ITEM 874.2**

**TRAFFIC SIGN REMOVED AND RESET**

**EACH**

Work under this Item shall conform to the relevant provisions of Subsection 828 of the Standard Specifications and the following:

Work to be done under this item shall include the dismantling, removal, transporting, and resetting of the existing traffic and street name signs at the locations indicated on the plans. The work also includes the removal and disposal of the existing sign supports and foundations. New posts shall be installed for all signs called to be removed and reset.

The Contractor shall exercise particular care in the dismantling, removal, and transporting of the existing sign, and when installing the existing signs designated to be reused on new posts. Any sign panel damaged by the Contractor or while in the Contractor's possession shall be replaced at the Contractor's expense.

The Contractor shall backfill with compacted gravel all holes resulting from the removal of the existing signs and their foundations and restore the area to match existing conditions of adjacent areas.

The existing signs shall not be removed and reset until the Engineer permits.

**METHOD OF MEASUREMENT**

Item 874.2 will be measured for payment by the each unit removed and reset.

One unit shall be defined as all signs attached on the same post, or as all signs mounted together on the same pair of posts if signs are mounted on multiple posts.

**BASIS OF PAYMENT**

Item 874.2 will be paid for at the Contract unit price bid per each, which price shall include all labor, tools, equipment, material, excavation, removal and disposal of the existing foundation, surface restoration, additional mounting hardware, transportation, and all incidental costs required to complete the work. Existing posts shall be legally disposed of at no additional cost.

New P-5 posts shall be measured and paid for separately under Item 847.1.

**ITEM 901.01**

**CONCRETE FOR FLOOD WALL**

**CUBIC YARD**

Work under this Item shall conform to the relevant provisions of Subsection 901 of the Standard Specifications and the following:

4,000 psi, 1.5-inch, 565 Cement Concrete shall be used to reconstruct the north flood wall as designated on the Contract Drawings and shall conform to all material requirements contained in Subsection M4.02.00 of the Standard Specifications.

**METHOD OF MEASUREMENT**

Item 901.01 will be measured for payment per Subsection 901.80 of the Standard Specifications.

**BASIS OF PAYMENT**

Item 901.01 will be paid for per Subsection 901.81 of the Standard Specifications.

Steel reinforcement for the flood wall reconstruction will be paid for separately under Item 910.11, Steel Reinforcement for Flood Wall – Epoxy Coated.

**ITEM 910.11**

**STEEL REINFORCEMENT FOR FLOOD  
WALL - EPOXY COATED**

**POUND**

Work under this Item shall conform to the relevant provisions of Subsection 901 of the Standard Specifications and the following:

Work under this Item includes procurement and placement of steel reinforcement related to the reconstruction of the north flood wall, as designated on the Contract Drawings.

Steel reinforcement required for the construction of the bridge is paid under Item 995., Bridge Superstructure, Bridge No. F-04-010 (1KR).

**METHOD OF MEASUREMENT**

Item 910.11 will be measured for payment per Subsection 901.80 of the Standard Specifications.

**BASIS OF PAYMENT**

Item 910.11 will be paid for per Subsection 901.81 of the Standard Specifications.

**ITEM 912.3****DRILLED & GROUTED #3 DOWELS****EACH**

The work to be done under this item shall consist of drilling and grouting holes in the existing abutments and wingwalls for steel reinforcing dowels as shown on the Plans.

The dowel embedment must be adequate to fully develop 125% of the yield strength of the bar. The embedment length, the method and equipment used to drill the dowel holes, and the diameter of the drilled hole shall at a minimum conform to the recommendations of the manufacturer and be submitted to the Engineer for approval.

**MATERIALS**

The cementitious grout to be used for these dowels shall be on the MassDOT Qualified Construction Materials List. Epoxy, vinyl, or polyester resin adhesives shall not be utilized.

Reinforcing steel dowels shall meet the requirements of ASTM A615 Grade 60. All reinforcing steel dowels shall be epoxy coated. Reinforcing steel dowels shall be incidental to the work under this item.

**CONSTRUCTION METHODS**

All dowel holes shall be air drilled provided that the minimum edge distance of 6 inches is observed. Should, in the Engineer's opinion, air drilling be inappropriate due to questionable strength of the existing concrete or stone masonry or insufficient edge distance, the dowel holes shall be diamond core drilled. The inner surfaces of diamond core drilled dowel holes shall be scored to develop sufficient keying action. The method of scoring of the dowel hole's inner surfaces shall be subject to the approval of the Engineer. The diameter of the drilled dowel holes shall be in accordance with the recommendations of the grout manufacturer. The holes shall be blown clear of any debris and prior to the placement of any grout material.

The drilling operation shall be performed without damage to any existing reinforcing or portion of the structure that is to remain in place. Any damage to any existing portion of the structure that is to remain in place shall be repaired to a condition equal to or better than that existing prior to the beginning of the Contractor's operations and shall be repaired at the Contractor's expense.

The Contractor shall strictly follow the recommendations of the manufacturer for mixing and placing the grout material prior to the placement of the dowels. The Contractor shall, at a minimum, adhere to the ACI code requirements regarding minimum and maximum temperatures while placing the grout. Any excessive grout around the hole after placement of the dowel shall be struck off smooth while the grout is still fresh.

**ITEM 912.3** (Continued)

The Contractor shall arrange with the materials manufacturer or distributor to have the services of a competent field representative at the work site prior to any drilling of the proposed dowel holes to instruct the work crews in proper dowel installation procedures. The field representative shall remain at the job site after work commences and continue to instruct until the representative and the Contractor, Inspector and/or Engineer are satisfied that the crew has mastered the technique of installing the dowels successfully. The representative shall make periodic visits to the project as the work progresses and shall confer on each visit with the Contractor, Inspector and/or Engineer. The manufacturer's field representative must be fully qualified to perform the work.

The Contractor shall have no claim for any variations in the diameter of the hole, the method of drilling the hole, or the type of grout used in anchoring the proposed dowels.

**METHOD OF MEASUREMENT**

Item 912.3 will be measured for payment by the each, for each drilled and grouted #3 dowel installed, complete in place.

**BASIS OF PAYMENT**

Item 912.3 will be paid for a the Contract unit price bid per each, which price shall include all labor, materials, tools, equipment, disposal of all materials, and all incidental costs required to complete the work.

No separate payment will be made for the services of the required field representative, any costs inconection therewith shall be included in the Contract unit price bid.

**ITEM 944.2****PRE-DRILLING FOR PILES****FOOT**

The work under this Item shall conform to the relevant provisions of Subsections 150 and 940 of the Standard Specifications and the following:

The work shall consist of drilling, boring, or augering holes for piles, and backfilling the holes, at the locations and to the depths indicated on the Contract Drawings, or as required by the Engineer. All pile holes shall be kept open for pile installation and backfilling. This work is anticipated to be done after the work described in Item 944.21 is completed.

**CONSTRUCTION METHODS**

Holes shall be drilled, bored, or augered through the in situ soils, rock, boulders, buried obstacles, debris, and the existing abutments. The Contractor shall include in his/her submittal under this Item all pertinent details of the required procedures for drilling the holes and maintaining the diameter of the holes for review by the Engineer. Pre-drilling for Piles shall be used to drill from the proposed pile cap bottom elevations down to estimated elevations as shown on the Plans.

Each hole shall be made using an auger, core barrel, or by other approved methods. Downhole hammers are not considered an approved method for this application due to vibration concerns at the existing underground sewer line and at the abutting properties. The Contractor shall ensure that each hole is drilled vertically within the horizontal tolerances specified in Subsection 940.65. The specified diameter of the hole is to be continuously maintained for the full depth, regardless of the characteristics of the materials being penetrated. If required by field conditions or as required by the Engineer, the Contractor shall simultaneously install at each hole a temporary steel casing to the bottom of the drilled hole having the required strength and size to maintain the specified diameter and location of each hole. The temporary steel casing shall be extracted after the pile is installed. Unless specifically authorized in writing by the Engineer, the Contractor shall carefully extract the full length of each temporary steel casing while the hole is simultaneously being filled with crushed stone without allowing the penetrated soil materials to collapse into, or otherwise reduce the specified diameter of the hole. All debris from pre-drilling excavation shall be removed from the site and will not be allowed to enter environmentally sensitive areas as required under project permits. All materials shall be satisfactorily disposed of by the Contractor.

The crushed stone for integral abutment piles shall conform to the requirements of M2.01.6 and shall be placed within each drilled hole to the limits shown on the Plans.

If the Contractor chooses to leave the casing in place, the cut-off elevation shall be subject to the approval of the Engineer.

**ITEM 944.2** (Continued)

**METHOD OF MEASUREMENT**

Item 944.2 will be measured for payment by the foot, measured along the centerline of the pre-drilled for pile hole, complete in place.

No payment will be made for any length of hole progressed below the elevation shown on the plans unless required by the Engineer.

If a temporary casing is used, no additional payment will be made for increased hole diameter to accommodate the temporary casing and the specified diameter in the plans.

**BASIS OF PAYMENT**

Item 944.2 will be paid for at the Contract unit price per foot, which shall include all labor, materials, equipment, and incidental costs required to complete the work. Said price shall also include the furnishing, installation and removal of temporary casing, and the removal and disposal of the drilling cutting, required to complete the work as required by the Engineer.

Crushed stone for integral abutment piles will be paid for under Item 156.13 Crushed Stone for Integral Abutment Piles.

**ITEM 944.21****TEST PROBING FOR PILE OBSTRUCTIONS****FOOT**

The work under this Item shall conform to the relevant provisions of Subsections 150 and 940 of the Standard Specifications and the following:

The work shall consist of drilling a test hole at each pile to the estimated pile tip elevation as shown on the Contract Drawings. The Contractor is advised of the potential existence of obstructions (boulders, etc.) at this site. The purpose of this work is to drill through and identify the extents of the obstructions to allow piles to be driven without damage and within alignment tolerances.

**CONSTRUCTION METHODS**

It is anticipated that the test probing will be performed with a 4-inch diameter casing similar to that used during geotechnical boring operations. The Contractor shall ensure that each hole is drilled vertically within the horizontal tolerances specified in Subsection 940.65. During the probing, the Contractor shall keep a record of the start and end elevations of any obstructions encountered. These obstructions will be drilled through with Item 944.3. If obstructions are not encountered at the end of the test probing, the hole shall be filled with clean sand borrow; see Item 944.3 for details.

The Contractor is permitted to drive piles without test probing. However, if obstructions are encountered prior to achieving the proposed pile tip elevation, the Contractor will be required to extract the pile, drill through the obstruction, replace damaged portions of the pile, and re-drive the pile at their own expense.

**METHOD OF MEASUREMENT**

Item 944.21 will be measured for payment by the foot, measured along the centerline of the hole, complete in place.

No payment will be made for any length of hole progressed below the elevation shown on the plans unless required by the Engineer.

**BASIS OF PAYMENT**

Item 944.21 will be paid for at the Contract unit price per foot, which price shall include all labor, materials, equipment, and incidental costs required to complete the work.



**ITEM 944.3****DRILLING FOR PILE OBSTRUCTIONS****FOOT**

The work under this Item shall conform to the relevant provisions of Subsection 940 of the Standard Specifications and the following:

The work under this item shall consist of drilling a hole where obstructions were encountered at each test hole in Item 944.21. This work shall be performed between bottom of pre-drilling elevations and the estimated pile tip elevations, as indicated on the Contract Drawings. Work above bottom of pre-drilling elevations is covered under Item 944.2.

**CONSTRUCTION METHODS**

The hole drilled for this item shall be no greater than the diagonal width of the pile unless otherwise approved by the Engineer. The Contractor shall drill through to the bottom of obstruction elevation noted in Item 944.21. The Contractor shall ensure that each hole is drilled vertically within the horizontal tolerances specified in Subsection 940.65. The purpose of drilling for pile obstructions is to drill through the extents of the obstructions to allow piles to be driven without damage and within alignment tolerances.

At the end of drilling, the hole shall be filled with clean sand borrow conforming to Subsection M1.04.0, Type b. The sand shall be loosely placed within each drilled hole without compaction. Unless specifically authorized in writing by the Engineer, the Contractor shall carefully extract the full length of each temporary steel casing while the hole is simultaneously being filled with sand without allowing the penetrated soil materials to collapse or otherwise reduce the diameter of the hole. If the sand settles in any hole during subsequent pile driving, the hole shall be refilled with sand borrow.

**METHOD OF MEASUREMENT**

Item 944.3 will be measured for payment by the foot of obstruction cleared. Measurement will be taken along the centerline of the hole. No payment will be made for any length of hole progressed below the elevations as identified in this specification, unless required by the Engineer.

**BASIS OF PAYMENT**

Item 944.3 will be paid for at the Contract unit price per foot, which price shall include all labor, materials, equipment, and incidental costs required to complete the work. Said price shall also include the furnishing, installation and removal of temporary casing, and filling of holes with clean sand borrow, required to complete the work.

---

**ITEM 953.1                      TEMPORARY SUPPORT OF EXCAVATION                      SQUARE YARD**

The work under this Item shall conform to the relevant provisions of Subsection 950 of the Standard Specifications and the following:

The work shall include all materials, equipment, and labor to provide temporary support of excavation during stage construction of the proposed bridge. The Contractor shall furnish, install, maintain, and remove a temporary excavation support system as required based upon the actual site conditions, for the maintenance of traffic on River St. during stage construction of the proposed bridge structure.

**CONSTRUCTION METHODS**

The Contractor shall submit to the Engineer for review and approval, drawings and calculations for the temporary support of excavation, stamped by a Professional Structural Engineer registered in the Commonwealth of Massachusetts, indicating the methods the Contractor intends to implement to support the excavation required for the construction of the proposed bridge. The selection of the system to be used for the temporary support of excavation shall be based on site conditions as inferred from the boring logs. Temporary sheeting, if selected, may need to be pre-augered in the top 15 feet before being driven to final elevation. The Contractor shall also submit for approval of the Engineer, a detailed plan for the removal of the temporary supports describing the proposed sequence, methods, impacts, and equipment to be used. Drawings and associated calculations shall be in accordance with the MassDOT LRFD Bridge Manual, 2013 Ed., and AASHTO LRFD Bridge Design Specifications, 9<sup>th</sup> Ed., AASHTO Guide Design Specifications for Bridge Temporary Works, 2<sup>nd</sup> Ed., and AASHTO LRFD Bridge Construction Specifications, 4<sup>th</sup> Ed. The Contractor shall also consider the load effects of vehicular collision impact on the barrier as a design load at the Extreme Event limit state on the top of the selected support of excavation system.

Any work done or materials ordered for the work involved prior to the approval of the design calculations, plans, and detail drawings shall be at the Contractor's own risk.

The Contractor shall accurately locate all utility lines and structures to ensure that the proposed temporary excavation support system will not interfere with any existing utilities and structures.

All material used for the temporary excavation support system shall be sound and free from strength impairing defects. Steel piles (if used) shall conform to the applicable requirements of Subsection 940. Treated timber if used shall conform to the applicable requirements of Subsection 955. All materials removed after completion of the proposed construction shall become the property of the Contractor and shall be disposed of properly offsite.

The temporary excavation support system must follow the design guidelines listed in the 2020 revision to the 2013 MassDOT LRFD Bridge Manual Part I Section 3.2.4.5 and 3.2.4.7 regarding when to cut off the temporary excavation support and leave in place. No additional payment will be made for cutting of excavation support to remain in place.

**ITEM 953.1** (Continued)

**METHOD OF MEASUREMENT**

Item 953.1 will be measured for payment by the square yard of Temporary Support of Excavation (SOE) complete in place, by multiplying the vertical length measured between the original ground surface at the site at the time the work commences and bottom of excavation as specified in the Contract plans by the horizontal length of the proposed temporary support. The quantity of temporary support to be paid shall be the maximum number of square yards satisfactorily installed measured on either, but not both sides, of adjacent construction stages as required by the Engineer.

**BASIS OF PAYMENT**

Item 953.1 will be paid for at the Contract unit price per square yard installed and accepted, which price shall include all labor, equipment, materials, shop drawings, submittals, and all incidental costs required to complete the work.

Payment of sixty percent (60%) of the Contract price shall be made upon completion of the installation of the SOE system as required and approved by the Engineer. Payment of the remaining forty percent (40%) of the Contract price shall be made upon the removal and proper disposal of the SOE system from the project.

**ITEM 987.31**                      **SPECIAL SLOPE PAVING UNDER BRIDGE -**                      **CUBIC YARD**  
**CEMENT CONCRETE**

The work under this Item shall conform to the relevant provisions of Subsection 983 of the Standard Specifications and the following:

The work shall include the placement of slope paving in front of the proposed abutments in close conformity with the lines and grades as shown on the Contract Drawings.

**MATERIALS**

Special slope paving shall meet the requirements 4,000 psi, 3/4-inch, 610 Cement Concrete specified in Subsection M4.02.00 of Division III, Materials in the Standard Specifications. All steel reinforcement (bars or welded wire fabric) shall be epoxy coated (M8.01.7: Epoxy Coated Reinforcing Bars) conforming to the material specifications.

**CONSTRUCTION METHODS**

The slope paving shall be placed as specified in Subsection 901: Cement Concrete; the surface shall be finished as specified in Subsection 901.68: Joints, Paragraph C.

**METHOD OF MEASUREMENT**

Item 987.31 will be measured for payment by the cubic yard of cement concrete furnished and installed, complete in place.

**BASIS OF PAYMENT**

Item 987.31 will be paid for at the Contract unit price per cubic yard, which price shall include all labor, tools, equipment, materials, and incidental costs required to complete the work.

Dowel bars to tie the special slope paving to the existing stone masonry are paid under Item 912.3, "Drilled and Grouted #3 Dowels".

**ITEM 989.2****REPAIRS TO CONCRETE****LUMP SUM**

The work under this Item shall conform to the relevant provisions of Subsection 901 of the Standard Specifications and the following:

The work under this item shall consist of restoring damaged areas of concrete as noted on the Contract Drawings.

Area to be restored includes the northwest quadrant in the vicinity of the temporary utility bridge, as noted on the Contract Drawings. The work shall include the removal of all unsound concrete, formwork as required, cleaning the surfaces of exposed concrete, applying a bonding agent to the surfaces to be repaired, and filling the damaged areas with cement concrete. The repaired surface shall receive a coating of the concrete sealant.

The following repair types are covered in this specification:

1. Repair concrete spalls (2 inches deep or less with no exposed rebar) with rapid set repair mortar.
2. Repair concrete spalls (6 inches deep or less with exposed rebar) with concrete.
3. Repair concrete spalls (greater than 6 inches deep) with rebar dowels anchored using an epoxy adhesive and concrete.

**MATERIALS****Concrete**

Concrete for repairs 6-inch deep or less and/or with exposed rebar shall conform to 4000 psi, 3/8-inch, 660 cement concrete as prescribed in Subsection 901 of the Standard Specifications.

Concrete for repairs greater than 6-inch deep shall conform to 4000 psi, 3/4-inch, 610 cement concrete as prescribed in Subsection 901 of the Standard Specifications.

**Rapid Set Repair Mortar**

Rapid Set Repair Mortar used for surface repairs shall be non-shrink type, suitable for vertical repairs, on the MassDOT Qualified Construction Materials list (QCML).

**Epoxy Bonding Agent**

Epoxy Bonding Agent for bonding fresh concrete to existing hardened concrete shall be a water-based, epoxy resin/Portland Cement bonding agent, on the MassDOT QCML.

**Epoxy Adhesive**

Epoxy adhesive for anchoring rebar dowels shall be a two-component, epoxy-resin bonding system for application to Portland cement concrete and on the MassDOT QCML.

---

**ITEM 989.2** (Continued)**Epoxy Coating for Rebar**

Epoxy coating for rebar shall be in accordance with Subsection M8.01.7 and on the MassDOT QCML.

**Concrete Sealant**

Concrete sealant shall be in accordance with Subsection M9.15.0 and on the MassDOT QCML.

All material certifications and product data sheets shall be submitted to the Engineer for approval.

**CONSTRUCTION METHODS**

The Contractor shall use suitable means to prevent demolition material and debris from falling into the river. The Contractor shall be responsible for removing any debris falling into the river. The Contractor shall take required precautions to protect existing utilities in place from damage during his/her operations.

All abrasive blasting performed as part of the work shall conform to all applicable Federal, State and local safety and pollution laws, regulations and ordinances. It is the Contractor's responsibility to conform to such laws, regulations and ordinances, and the cost of such conformance shall be included in the unit price bid for this work.

Hammers over 30 pounds, rivet busters, and whip hammers are not allowed for the removal of concrete.

The surfaces of the concrete to be patched will be examined by the Resident Engineer by sounding with a hammer. The approximate limits of unsound concrete will be indicated with paint or lumber crayon.

**Removal of Concrete**

All unsound concrete shall be removed. After the unsound concrete has been removed, small irregularities shall be cut back so that the limit lines are reasonably uniform and the edges approximately normal to the original concrete surface.

**Inspection, Cleaning and Coating of Reinforcing Steel**

For repair types with exposed reinforcing steel, the exposed surfaces of the reinforcing steel shall be thoroughly cleaned by abrasive blasting. No grease, dust, rust, or laitance shall be allowed to remain. Apply epoxy coating on the cleaned surfaces of rebar. Where section loss of rebar is greater than 20% by area, splice a new section of rebar matching the original size of the deteriorated rebar. All reinforcing steel that is loose shall be tied tightly together using wire ties.

---

**ITEM 989.2** (Continued)**Rebar Doweling**

For repairs greater than 6 inches deep, #4 reinforcing bars shall be doweled into the existing concrete at embedment and spacings as specified on the Contract Drawings.

**Application of Epoxy Bonding Agent**

The surface of the old concrete shall be thoroughly cleaned by abrasive blasting to remove all loose particles, dust, and other films. When the ambient temperature is 40 degrees F. or above, and rising or holding, the bonding compound shall be applied to this clean surface by spray or by brushing, using brushes of a size and/or design that will reach through the reinforcing steel to the underlying concrete surface. The bonding compound shall be applied in horizontal and vertical strips each 6 inches wide with 6 inch uncovered strips between. The manner of mixing, the rate of application, and the allowable open or contact time before placing the concrete or grout shall be in accordance with the recommendations of the bonding compound manufacturer. If the concrete is not placed against the bonding compound within the allowable open time, it shall be rejuvenated by the application of a second coat over the first, if approved by the Engineer.

**Forms**

All patches shall be formed over the entire surface with forms approved by the Engineer. They shall be held securely in place and able to withstand the hydrostatic pressure resulting from the placement of the green concrete. Forms shall be built such that the surface of the resulting patch will duplicate the original lines of the concrete removed. Form faces shall be of new finished plywood or steel, or other smooth surface as approved by the Engineer prior to use. Forms will be provided with a top chute, at a maximum spacing of 4 feet for providing a compression head of concrete in the form. The overfilled area shall be struck off flush when forms are removed. Forms shall be placed snugly against the surface of the old concrete at the edges of the patch and shall extend beyond the edges at least three inches. They shall not deflect under the placement of the fresh concrete.

**Concrete Sealant**

Sealer shall be applied in accordance with Subsection 901.72 of the Standard Specifications.

**BASIS OF PAYMENT**

Item 989.2 will be paid at Contract Lump Sum price, which price shall include removal of all deteriorated concrete designated by the Engineer; cleaning by abrasive blasting; furnishing and applying bonding agent and epoxy coating to rebar; splicing new rebar to deteriorated rebar sections; installing rebar dowels in repair areas greater than 6 inches deep; placing, curing and finishing of repair mortar and/or cement concrete; applying sealant to the finished surface, and for all labor, materials, equipment, and all incidental costs required to complete the work. Service and advice of manufacturer's representatives, if and as required by the Engineer, shall be considered incidental to the work under this item.

---

**ITEM 991.1**      **CONTROL OF WATER - STRUCTURE NO. F-04-010**      **LUMP SUM**

The work under this Item shall conform to the relevant provisions of Subsection 140 of the Standard Specifications and the following:

The work shall include all materials, equipment, and labor to support dewatering operations, sufficient to provide a dry work area within the excavated areas during the following construction operations: bridge excavation, placement of crushed stone for bridge foundation, placement of concrete for flood wall reconstruction, and placement of gravel borrow for bridge foundation.

All water control and dewatering operations shall be in compliance with the approved environmental permits included in these bid documents.

**CONSTRUCTION METHODS**

The Contractor shall submit to the Engineer for review and approval, a Control of Water procedure, prepared and stamped by a Professional Engineer registered in the Commonwealth of Massachusetts, indicating the dewatering methods the Contractor intends to implement to provide a dry work area within the excavated areas. The procedure shall include the means of removing all sediment, measures to control the discharge of pollutants into the water resource areas, and flood prevention of the excavated areas. The temporary cofferdam at the proposed reconstruction of the flood wall shall include a means for the existing drainage outfall to drain into the river. Upon acceptable completion of the construction operations identified above, the Contractor shall remove all materials and equipment that support the dewatering operations and diversion features and restore disturbed areas to natural conditions and to the satisfaction of the Engineer.

The Contractor is advised that the effectiveness of the water control method used will vary based on the field conditions and the time at which the actual excavation work is being performed. The Engineer has the right to order the Contractor to stop all excavation operations when in his/her judgment the Contractor's water control operations are failing to produce adequate results or are posing a threat to the environment.

**BASIS OF PAYMENT**

Item 991.1 will be paid for at the contract lump sum price, which price shall include all labor, materials, equipment, and incidental costs required to complete the work.

Payment of sixty percent (60%) of the Contract price shall be made upon completion of the installation of the water control system to the satisfaction and approval of the Engineer. Payment of the remaining forty percent (40%) of the Contract price shall be made upon the removal and satisfactory disposal of the water control system from the project.



**ITEM 992.3**

**TEMPORARY SUPPORTS FOR  
BRIDGE STRUCTURE**

**LUMP SUM**

The work under this Item shall consist of the design, installation, maintenance and removal of temporary supports for the deck overhang of the existing bridge superstructure in Phase 1A. The temporary supports shall consist of adjustable bridge overhang brackets and timber to support the deck overhang; and timber blocking on the bottom flanges of the exterior bay to prevent kickout of the bottom flange of the exterior beam.

**CONSTRUCTION METHODS**

The Contractor shall submit working drawings and calculations prepared and sealed by a Professional Structural Engineer registered in the Commonwealth of Massachusetts. The drawings shall provide full details, dimensions, and types of materials proposed for use. The temporary supports shall not be installed until authorization to proceed is given by the Engineer.

Upon completion of the work or when required by the Engineer, the temporary supports shall be removed.

**BASIS OF PAYMENT**

Item 992.3 will be paid for at the Contract lump sum price, which price shall include all design, labor, tools, equipment, materials, testing, loading, transportation, and incidental costs required to complete the work.

**ITEM 993.1****TEMPORARY BRIDGE NO. F-04-010T****LUMP SUM**

The work under this Item shall conform to the relevant provisions of Subsection 960 of the Standard Specifications and the following:

The work shall consist of the construction of a temporary utility bridge structure adjacent to Bridge No. F-04-010 to the lines and grades shown on the plans, and in accordance with guidelines of the manufacturer's requirements and recommendations. The work includes design and fabrication, bridge excavation, gravel borrow for treated timber mat foundation, treated timber mats, and the acquisition, assembly and erection of the temporary panel bridge and associated hardware. After the intended use of the temporary utility bridge is complete, the temporary utility bridge and treated timber mats shall be completely dismantled and transported off site, and all excavated area shall be restored to its original condition or better.

**CONSTRUCTION METHODS****Lease, Assembly, Erection and Dismantling of Temporary Utility Bridge**

The work under this Heading shall consist of the lease of required parts from the supplier and the assembly and erection of the temporary utility bridge as shown on the plans and specified below.

The pre-engineered panelized temporary utility bridge system shall be manufactured by any of the following companies or an approved equivalent:

Bridge Brothers, 57 Old Ivy Sq NE, Atlanta, GA 30342  
Telephone: (866) 258-3401, [www.bridgebrothers.com](http://www.bridgebrothers.com)

Acrow Corporation of America, 181 New Road, Parsippany, NJ 07054  
Telephone: (201) 933-0450, [www.acrow.com](http://www.acrow.com)

Liberty Products, LLC, 187 Dutton Road, Section, AL 35771  
Telephone: (256) 996-2342, [www.libertycatwalks.com](http://www.libertycatwalks.com)

**A. Materials**

All components of the temporary panelized utility bridge shall be galvanized steel in accordance with the applicable ASTM standards. Each component of the temporary panelized utility bridge (except pins, threaded components and other fasteners) shall individually bear a marking that includes the part identification number, name of manufacturer and model number of the utility bridge. The markings are intended as a method for the Department to easily and readily identify all components of the panelized utility bridge.

Field splices shall be fully bolted with ASTM F3125 Grade A325 galvanized high strength bolts.

Treated timber mats shall be in accordance with Subsection 955 in the Standard Specifications.

Utility supports shall be per utility owner specifications at spacings as shown on the Contract Drawings. The contractor shall provide connection details for the utility supports on the utility bridge to the Engineer for review.

---

**ITEM 993.1** (Continued)**B. Technical Representative**

The Contractor shall hire a technical representative from the manufacturer to advise and assist the Contractor during the transport, assembly, erection and dismantling phases of the temporary utility bridge.

The Contractor shall be completely responsible for the expense of the services of the required technical advisor and the Contract bid shall include full compensation for all costs in connection therewith. The services of the technical representative are in addition to the Contractor's staff.

The technical representative shall be present during the erection and dismantling of the temporary utility bridge.

**C. Erection of Temporary Utility Bridge**

The Contractor should visit the site prior to submitting his bid and include in his bid, the proposed method of installing the bridge that is acceptable to and agreed with the supplier.

Any material that accidentally falls into the river shall be removed immediately at the Contractor's expense. The Contractor shall ensure the stability of the structure during erection operations.

**D. Inspection and Maintenance**

The Contractor shall be responsible for the inspection and maintenance of the bridge for all duration of project use ensuring its safe serviceability.

**E. Dismantling and Removal of Temporary Utility Bridge**

The work to be done under this Heading shall conform to the relevant provisions of Subsection 112 of the Standard Specifications and the following:

The Contractor may remove the temporary utility bridge when approved by the Engineer. The Contractor shall proceed in accordance with the recommendations of the manufacturer's technical representative. All components of the temporary utility bridge and treated timber mats shall be completely disassembled and removed off site.

**F. Submittals**

The Contractor shall submit to the Engineer for review and approval the following: a complete set of design calculations, treated timber mat foundation sizing, utility support and connection details, complete assembly and erection/dismantling plans, elevations, details, parts list, erection/dismantling sequence and installation procedures. The installation procedure shall include crane capacity, location, equipment, tools, devices etc. The requirements for equipment and all procedures utilized shall be in conformance with the intent of Subsection 960.61 Erection. Erection procedures, design calculations and drawings should certify that all structural members are adequately braced and supported throughout the erection process.

**ITEM 993.1** (Continued)

All submittals shall be stamped by a Professional Structural Engineer registered in the Commonwealth of Massachusetts. Erection shall not commence until assembly and erection plans have been approved by the Engineer.

**BASIS OF PAYMENT**

Item 993.1 will be paid at the Contact Lump Sum price, which price shall include all labor, equipment, materials, tools, rigging, design, shop drawings, submittals, and all incidental costs required to complete the work as specified and as required by the Engineer.

For estimating partial payments, the work will be separated into distinct phases as listed below and the value of each will be assigned a percentage of the lump sum:

|                           |     |
|---------------------------|-----|
| Design & Fabrication..... | 35% |
| Installation.....         | 35% |
| Dismantling.....          | 30% |

Partial payment for each phase will be based on acceptable work completed as determined by the Engineer.

Dismantling will be paid after removal of all equipment and materials and restoring the excavated areas to its original condition or better.

**ITEM 995.****BRIDGE SUPERSTRUCTURE,  
BRIDGE NO. F-04-010 (1KR)****LUMP SUM**

The work under this Item shall conform to the relevant provisions of Subsection 995 of the Standard Specifications and the specific requirements stipulated below for the component parts of this Item. For those component parts where no specific requirement is stipulated, the Standard Specifications shall apply except for payment.

Work under this Item shall include all materials, equipment and labor needed to construct the following: laminated elastomeric bearings; galvanized steel girders with steel diaphragms and utility supports; shear connectors; reinforced concrete deck and concrete sidewalks; Superpave wearing surface; reinforced concrete integral abutments; reinforced concrete curtain walls; reinforced concrete approach slabs; metal bridge railing; asphaltic bridge joint system; precast endposts; casing pipe for water line and sleeve for gas main at abutments; spray applied membrane waterproofing; and damp-proofing.

The work does not include any items listed separately in the proposal. Payment for materials shown on the Contract Drawings as being part of this bridge structure or which may be incidental to its construction and are not specifically included for payment under another Item shall be considered incidental to the work performed under this Item and shall be included in the unit price of the component of which they are a part.

**4000 PSI, 3/4 INCH, 585 HP CEMENT CONCRETE**

The work to be done under this heading shall conform to the relevant provisions of Subsection 901 of the Standard Specifications and the following:

4000 PSI, 3/4 INCH, 585 HP Cement Concrete shall be used to construct the deck slab and integral abutment diaphragm and wingwalls as designated on the Contract Drawings.

4000 PSI, 3/4 INCH, 585 HP Cement Concrete shall conform to all material requirements contained in Subsection M4.06.1 of the Standard Specifications.

**MECHANICAL REINFORCING BAR SPLICER**

The mechanical reinforcing bar splicers shall conform to all material requirements contained in Subsection M8.01.9 of the Standard Specifications.

**SHEAR CONNECTORS**

The shear connectors shall conform to all material requirements contained in Subsection M8.04.1 of the Standard Specifications.

---

**ITEM 995.** (Continued)**DRILLED AND GROUTED #4 DOWELS**

The Contractor shall follow the requirements as specified for Item 912.3 Drilled and Grouted #3 dowels.

**CORING AND GROUTING ANCHOR BOLTS**

The contractor shall follow the requirements as specified for Item 912.3 Drilled and Grouted #3 dowels, with the following modifications:

Anchor bolts shall meet the requirements as shown on the Contract Drawings. Anchor bolts shall be incidental to the work under this item.

All anchor bolt holes shall be diamond core drilled.

**PRECAST CONCRETE HIGHWAY GUARDRAIL TRANSITION****A. General.**

The work under this Heading consists of fabricating, transporting and installing precast concrete highway guardrail transitions and includes all required labor, materials, and equipment to complete the work as shown on the Plans. The work shall conform with the MassDOT Standard, Supplemental, and Interim Specifications and the requirements of the current AASHTO LRFD Bridge Construction Specifications, supplemented by the current relevant provisions of the latest edition of PCI MNL-116 (The Manual for Quality Control for Plants and Production of Precast and Prestressed Concrete Products), except as noted herein.

**QUALITY ASSURANCE****A. General.**

Quality Assurance includes all the planned and systematic actions required to provide confidence that a product or facility will perform satisfactorily in service. It is an all-encompassing term that includes Quality Control (performed by the Fabricator) and Acceptance (performed by MassDOT). Quality Control is the system used by the Contractor and Fabricator to monitor and assess their production processes at the plant facility and installation activities at the project site to ensure that the final product will meet the specified level of quality. Acceptance includes all factors used by MassDOT to determine the corresponding value for the product. MassDOT Acceptance inspection at the plant facility is intended as a means of evaluation of compliance with contract requirements. Contractor and Fabricator Quality Control activities and MassDOT Acceptance activities shall remain independent from one another. MassDOT Acceptance activities shall not replace Fabricator Quality Control activities.

**ITEM 995.** (Continued)**B. Fabricator Quality Control.**

Quality Control shall be performed by the Fabricator to ensure that the product is fabricated in conformance with the specifications herein. The Fabricator shall maintain a Quality Control system to monitor, assess, and adjust placement and fabrication processes to ensure the Precast Concrete Bridge Element(s) meet the specified level of quality, through sufficient Quality Control sampling, testing, inspection, and corrective action (where required). The Fabricator's Quality Control system shall address all key activities during the placement and fabrication and shall be performed in conformance with the Fabricator's NPCA or PCI Certification. Quality Control documentation shall meet the requirements of the *Fabricator Quality Control – Documentation* section below. Upon request, Fabricator Quality Control documentation shall be provided to the MassDOT Plant Inspector.

**1. Plant.**

Prior to the fabrication of Precast Concrete Bridge Elements, the Fabricator's precast concrete plant shall obtain the following:

- (a) Certification by the National Precast Concrete Association (NPCA) Plant Certification Program or Precast/Prestressed Concrete Institute (PCI) Plant Certification Program, for the applicable types of Precast Concrete Bridge Element(s) being fabricated
- (b) MassDOT Prequalification
- (c) MassDOT Mix Design Approval

All concrete for a given Precast Concrete Bridge Element shall be produced by a single company and plant, unless otherwise approved by the Engineer.

**2. Personnel.**

The Fabricator shall provide adequate training for all QC personnel in accordance with NPCA or PCI certification. There shall be sufficient personnel trained and certified to perform the tests listed under Subsection M4.02.13, Part D. At a minimum, the Fabricator's Quality Control Personnel shall maintain the following qualifications and certifications:

- (a) QC Manager with an active NETTCP Field Technician or ACI Concrete Field Testing Technician – Grade I certification or higher, and a minimum of 4 years continuous experience in the manufacture of Precast Concrete Bridge Elements for state transportation departments. The QC Manager shall be on site while the batch plant is producing and placing concrete for MassDOT projects.
- (b) A Technician/Inspector having the Precast/Prestressed Concrete Institute (PCI) Technician/Inspector Level I or NorthEast Transportation Training and Certification Program (NETTCP) Precast Concrete Inspector, or higher.

The Contractor shall submit to the Engineer a copy of the Fabricator's Quality Control Personnel required qualifications, as specified above.

**ITEM 995.** (Continued)**3. Laboratory.**

The Fabricator shall provide a room of sufficient size to house all equipment and to adequately perform all testing. The room shall have either a separate moisture storage room or curing box for concrete cylinders, and it shall be thermostatically controlled to maintain temperatures consistent with AASHTO T 23. It shall include a desk and file cabinet for proper record keeping, and have good lighting and ventilation. This room shall be kept for testing and quality control and not used for any other purpose. An additional desk and file cabinet shall be provided for exclusive use of the Engineer. No exception from these requirements will be allowed without the express written permission of the Engineer.

**4. Testing Equipment.**

At a minimum, the Fabricator's plant facility shall have the following testing equipment:

- (a) Air Content Meter Type A or B: AASHTO T 152
- (b) Air Content Meter Volumetric Method: AASHTO T 196 (Required for Lightweight Concrete)
- (c) Slump Cone: AASHTO T 119
- (d) Cylinder Molds AASHTO M 205
- (e) Concrete Testing Machine: AASHTO T 22
- (f) Screening Sieve: AASHTO T 27, AASHTO T 11
- (g) Curing Box: AASHTO T 23
- (h) Spread Test Base Plate for Self-Consolidating Concrete (SCC): ASTM C1611
- (i) All other equipment prescribed by AASHTO and ASTM standards for the tests to be performed by the Fabricator as specified

**5. Inspection.**

Quality Control personnel shall monitor and inspect the fabrication of each Precast Concrete Bridge Element. Quality Control personnel shall report all inspection activities on Quality Control Inspection Reports and non-conformances on Non-Conformance Reports (NCRs) throughout the entire fabrication process, as specified herein.

**6. Temperature Monitoring.**

At a minimum, the Fabricator shall monitor, record, and report the temperatures of the form, ambient temperatures surrounding the concrete, and temperatures of the concrete continuously, without interruption as specified below:

- (a) Prior to placement of concrete to verify that  $T_i \geq 50^\circ\text{F}$ .
- (b) Immediately after placement to verify that  $T_i \geq 50^\circ\text{F}$  is maintained.
- (c) Throughout the entire duration of the curing cycle, at regular intervals not to exceed one hour until 100% Design Strength ( $f'_c$ ) is attained and concrete has cooled to within  $40^\circ\text{F}$  of the ambient temperature surrounding the Precast Concrete Bridge Element.



**ITEM 995.** (Continued)

At a minimum, the temperature measuring devices shall record and report the temperature of the concrete to the nearest 2°F. At least two temperature sensors (thermocouples) shall be positioned to record the maximum and minimum anticipated concrete temperatures. The anticipated minimum temperature shall be measured with one or more thermocouples at a distance no greater than 2 inches from the surface of the thinnest section. The anticipated maximum temperature shall be measured with one or more thermocouples at the center of the thickest section. Proposed temperature measurement locations shall be submitted to the Engineer for approval. Temperature recording devices shall be located within the curing enclosure and calibrated as required by PCI MNL-116 Section 4.18.4. Maximum heat increase and cool down rates shall comply with PCI MNL-116, Section 4.19. The Contractor shall furnish temperature logs recorded at a minimum frequency of once per hour to the Inspector as required, with each post-pour QC inspection report.

**7. Sampling and Testing.**

At a minimum, the Fabricator shall perform random Quality Control sampling and testing as specified in *Table 1: Quality Control Sampling and Testing*. The Fabricator shall perform additional Quality Control sampling and testing on concrete that has been retempered with admixtures or hold-back water during fabrication. Test Specimens shall conform to the requirements of Section M4.02.13 of the MassDOT Standard and Supplemental Specifications and AASHTO R 60, with the exception of the Stripping (80%  $f'_c$ ) set of cylinders. Stripping (80 %  $f'_c$ ) cylinders shall be cured in the same location and environment as the Precast Bridge Elements they represent. If approved by the Engineer, compressive strength cylinder match curing equipment, that maintains the same concrete conditions that the corresponding Precast Bridge Element is exposed to, may be utilized in lieu of Stripping (80 %  $f'_c$ ) field cured cylinders, with the use of thermocouples, controllers, and heaters.

**ITEM 995.** (Continued)**Table 1: Quality Control Sampling and Testing**

| Quality Characteristic     | Test Method  | Sample Size   | Specification Limit                             | Lot Size <sup>(c)</sup>  | Sublot Size <sup>(d)</sup> | Frequency                              | Point of Sampling  |
|----------------------------|--------------|---|---|--|----------------------------|--|--------------------|
| Slump (in.) <sup>(a)</sup> | AASHTO T 119 | Per AASHTO  | ≤ 8 in. or as approved by the Engineer          | Total Quantity of Concrete (cy) produced on a Contract, per Type of Element fabricated, per Mix Design | 20 cy                      | One (1) per Sublot or fraction thereof | Point of Discharge |
| Air Content (%)            | AASHTO T 152 | Per AASHTO  | 5% ≤ % ≤ 8%                                     |  |                            |  |                    |
| Temperature (°F)           | AASHTO T 309 | Per AASHTO  | 50°F ≤ °F ≤ 90°F                                |  |                            |  |                    |
| Compressive Strength (psi) | AASHTO T 22  | Stripping<br>Cylinders:<br>One (1) set of<br>Three (3)<br>4 x 8 in. | ≥ 80% f <sub>c</sub> at Stripping               |  |                            |  |                    |
|                            |              | 7-day<br>Cylinders:<br>One (1) set of<br>Three (3)<br>4 x 8 in.     | For Information at 7 days                       |  |                            |  |                    |
|                            |              | 28-day<br>Cylinders:<br>One (1) set of<br>Three (3)<br>4 x 8 in.    | ≥ 100% f <sub>c</sub> at 28 days                |  |                            |  |                    |
|                            |              | 56-day<br>Cylinders:<br>One (1) set of<br>Three (3)<br>4 x 8 in.    | ≥ 100% f <sub>c</sub> at 56 days <sup>(b)</sup> |  |                            |  |                    |

**Notes:**

- (a) Self-consolidating concrete (SCC) shall meet the requirements of M4.02.17.
- (b) 56-day Compressive Strength test specimens shall require testing only when 28-day Compressive Strength test specimens have failed to meet Design Strength (f<sub>c</sub>).
- (c) Lot shall be defined as a specific quantity of material from a single source, produced or placed by the same controlled process.
- (d) Sublot shall be defined as an equal division or part of a Lot from which a sample of material is obtained in order to assess the Quality Characteristics of the Lot.

**ITEM 995.** (Continued)**8. Certificate of Compliance.**

The Fabricator shall provide a Certificate of Compliance in accordance with Standard Specifications, Division I, Section 6.01, stating that QC test cylinders have achieved the design strength,  $f'_c$ . A Certificate of Compliance shall accompany each shipment and shall be presented to the MassDOT Resident Engineer or designee upon delivery to the site.

**9. Documentation.**

At a minimum, the Fabricator shall maintain a filing system for the following QC records and documentation. All QC records and documentation shall be made available to MassDOT upon the request of the Department.

- (a) Current MassDOT Approved Mix Design Sheet(s) and Approval Letter(s)
- (b) PCI or NPCA Certification
- (c) Current Qualifications and Certifications for QC Manager(s) and QC Technician(s)
- (d) Most current set of Approved Shop Drawings
- (e) Approved Placement, Finishing and Curing Plan
- (f) Approved Dunnage Plan
- (g) Fabricator Certificate of Compliance for each fabricated Precast Concrete Bridge Element
- (h) Admixture Manufacturer's Certification of Compliance for each approved Admixture
- (i) Completed QC Inspection Report for each fabricated Precast Concrete Bridge Element
- (j) Identification Number for each fabricated Precast Concrete Bridge Element
- (k) Time and date of casting of each fabricated Precast Concrete Bridge Element
- (l) Date of stripping of each fabricated Precast Concrete Bridge Element
- (m) Batch Ticket Printout reporting the quantity of concrete produced for each batch of concrete produced
- (n) Concrete temperature records for each Precast Concrete Bridge Element fabricated
- (o) QC Test Report Forms for each subplot of concrete produced
- (p) Non-Conformance Reports (NCRs)
- (q) Documentation of Repairs (if applicable)

**C. Acceptance.**

MassDOT will perform Acceptance inspection, sampling, and testing during fabrication and installation, to evaluate the quality and degree of compliance of the fabricated Precast Concrete Bridge Element to MassDOT specifications. Additionally, MassDOT Inspectors will monitor the Fabricator's Quality Control activities to ensure the Fabricator is properly administering Quality Control in conformance with the Fabricator's NPCA or PCI Certification. Acceptance inspection and test results not meeting MassDOT specifications will result in Non-conformance Reports (NCR) being issued by MassDOT to the Fabricator or Contractor for corrective action. Final Acceptance for the fabricated Precast Concrete Bridge Elements shall be determined by MassDOT.

**ITEM 995.** (Continued)**1. Inspection.**

A MassDOT MassDOT Inspector will be assigned to perform Acceptance activities during fabrication, which includes the inspection of the materials, work procedures, and Precast Concrete Bridge Elements. At least seven (7) days prior to the scheduled start of fabrication, the Fabricator shall contact the MassDOT Research and Materials Section (RMS) to provide notice of the scheduled fabrication start date. The Fabricator shall complete the following activities prior to notifying MassDOT RMS of the scheduled start date:

- a) Receive approval for all submitted Fabricator cement concrete mix designs from the MassDOT Research and Materials Section for the current year, as specified under the *Mix Design* section and *Table 3: Trial Batch Sampling Testing for New Mix Designs*. Self-consolidating concrete shall meet the requirements of M4.02.17.
- b) Receive approval for the submitted Fabricator Placement, Finishing, and Curing Plan from the MassDOT Research and Materials Section, as specified under the *Placement, Finishing, and Curing Plan* section.
- c) Receive Engineer of Record approved shop drawings from the MassDOT Research and Materials Section as specified under the *Shop Drawings* section.
- d) Participate in the pre-production meeting, as described under the *Pre-Production Meeting* section (if required).

Prior to the start of fabrication, the Fabricator shall review the fabrication schedule with the MassDOT Inspector. Fabrication shall only proceed when:

- a) The QC Inspector and MassDOT Inspector are present to inspect the Precast Concrete Bridge Element(s) being fabricated.
- b) The QC Manager is present at the Fabricator's plant.

The Fabricator shall grant access to all required areas of the Fabricator's plant to the MassDOT Inspector, during the hours of fabrication. Fabrication without MassDOT Inspector access to required areas is prohibited, and will result in the rejection of the fabricated Precast Concrete Bridge Element(s).

Additionally, the MassDOT Inspector will monitor the adequacy of the Fabricator's Quality Control activities. MassDOT Inspector Acceptance activities performed at the Fabricator's plant shall remain independent from the Fabricator, and does not replace the Fabricator's required Quality Control activities.

**2. Sampling and Testing.**

At a minimum, the MassDOT Inspector will perform random Acceptance sampling and testing for each Sublot of concrete produced as specified in Table 2: Acceptance Sampling and Testing. The MassDOT Inspector will also perform Acceptance sampling and testing on concrete that has been retempered with admixtures or hold-back water during production. Test Specimens will conform to the requirements of Section M4.02.13 of the MassDOT Standard and Supplemental Specifications and AASHTO R 60.

**ITEM 995.** (Continued)**Table 2: Acceptance Sampling and Testing**

| Quality Characteristic     | Test Method                | Sample Size   | Specification Limit                              | Lot Size <sup>(c)</sup>  | Sublot Size <sup>(d)</sup> | Frequency                              | Point of Sampling  |
|----------------------------|----------------------------|---|--|--|----------------------------|--|--------------------|
| Slump (in.) <sup>(a)</sup> | AASHTO T 119               | Per AASHTO  | ≤ 8 in. or as approved by the Engineer           | Total Quantity of Concrete (cy) produced on a Contract, per Type of Element fabricated, per Mix Design | 20 cy                      | One (1) per Sublot or fraction thereof | Point of Discharge |
| Air Content (%)            | AASHTO T 152               | Per AASHTO  | 5% ≤ % ≤ 8%                                      |  |                            |  |                    |
| Temperature (°F)           | AASHTO T 309               | Per AASHTO  | 50°F ≤ °F ≤ 90°F                                 |  |                            |  |                    |
| Compressive Strength (psi) | AASHTO T 22<br>AASHTO T 23 | 7-day<br>Cylinders:<br>One (1) set of Three (3)<br>4 x 8 in.  | For Information at 7 days                        |  |                            |  |                    |
|                            |                            | 28-day<br>Cylinders:<br>One (1) set of Three (3)<br>4 x 8 in. | ≥ 100% f' <sub>c</sub> at 28 days                |  |                            |  |                    |
|                            |                            | 56-day<br>Cylinders:<br>One (1) set of Three (3)<br>4 x 8 in. | ≥ 100% f' <sub>c</sub> at 56 days <sup>(b)</sup> |  |                            |  |                    |

**Notes:**

- (a) Self-consolidating concrete (SCC) shall meet the requirements of M4.02.17.
- (b) 56-day Compressive Strength test specimens shall require testing only when 28-day Compressive Strength test specimens have failed to meet Design Strength (f' <sub>c</sub>).
- (c) Lot shall be defined as a specific quantity of material from a single source, produced or placed by the same controlled process.
- (d) Sublot shall be defined as an equal division or part of a Lot from which a sample of material is obtained in order to assess the Quality Characteristics of the Lot.

**ITEM 995.** (Continued)**MATERIALS****A. Materials.**

Materials shall meet the following specifications (if applicable):

|   |              |
|---|--------------|
| General                                   | M4.00.00     |
| Portland Cement                           | M4.01.0      |
| Blended Hydraulic Cements                 | M4.01.1      |
| Fly Ash                                   | M4.01.2      |
| Cement Concrete                           | M4.02.00     |
| Cement                                    | M4.02.01     |
| Cement Mortar                             | M4.02.15     |
| Aggregates                                | M4.02.02     |
| Lightweight Aggregates                    | M4.02.03     |
| Water                                     | M4.02.04     |
| Cement Concrete Additives                 | M4.02.05     |
| Proportioning                             | M4.02.06     |
| Mixing and Delivery                       | M4.02.10     |
| Test Specimens                            | M4.02.13     |
| Mortar for Filling Keyways                | M4.04.0      |
| Slag                                      | AASHTO M 302 |
| High Performance Cement Concrete          | M4.06.1      |
| Self-Consolidating Concrete (SCC)         | M4.02.17     |
| Controlled Density Fill – Non-Excavatable | M4.08.0      |
| Reinforcing Bars                          | M8.01.0      |
| Epoxy Coated Reinforcing Bars             | M8.01.7      |
| Galvanized Reinforcing Bars               | M8.01.8      |
| Welded Wire Reinforcement                 | M8.01.2      |
| Mechanical Reinforcing Bar Splicer        | M8.01.9      |
| Lifting Devices                           | PCI MNL-116  |
| Corrugated Metal Pipe                     | AASHTO M 36  |

**1. Cement Concrete Mix Design.**

The cement concrete shall be comprised of specified proportions of water and MassDOT approved aggregates, cement, supplementary cementitious materials (SCMs), and admixtures to form a homogenous composition. Cement concrete for Precast Concrete Bridge Elements shall meet the requirements of M4.06.1 High Performance Cement Concrete, with the exception that the “Total Cementitious Content” specified shall be considered the “Maximum Allowable Cementitious Content”. When used, self-consolidating concrete (SCC) shall meet the requirements of M4.02.17.

Prior to production of cement concrete, the Fabricator shall report and submit all proposed mix design formulations and its constituent materials onto the MassDOT Cement Concrete Mix Design Sheet to the MassDOT Research and Materials Section for review and approval. All mix design yields shall be designed for 1.0 cubic yards of concrete, with an allowable tolerance of +/- 1.0 %. All liquids incorporated into the proposed mix design(s) shall include both water and admixtures in the liquid mass calculation.

**ITEM 995.** (Continued)

During production of cement concrete, the Fabricator shall not alter the previously approved mix design formulation or its constituent materials. Proposed alterations in source, type, batch quantity, or gradation to any of the constituent materials of the previously approved mix design formulation shall require a new MassDOT Mix Design Sheet submission to the MassDOT Research and materials Section for review and approval. Fabrication shall not occur without prior MassDOT mix design approval.

The Fabricator shall notify MassDOT RMS to schedule trial batch testing for the new mix design(s). Trial batch testing shall meet the following requirements:

- a) Performed by a qualified laboratory and/or AASHTO accredited laboratory.
- b) Performed and/or sampled in the presence of a MassDOT Inspector.
- c) Meet the requirements as specified in *Table 3: Trial Batch Sampling Testing for New Mix Designs*. Self-consolidating concrete (SCC) shall meet M4.02.17.

Failure to perform all of the required trial batch testing or provide MassDOT RMS trial batch test results within the Specification Limits (as specified in Table 3) will result in the disqualification of the Fabricator's proposed mix design(s).

**Table 3: Trial Batch Sampling and Testing for New Mix Designs**

| Quality Characteristic  | Test Method                   | Sample Size  | Specification Limit  | Performed By    |
|---|-------------------------------|--|--|-----------------|
| Slump <sup>(a)</sup>  | AASHTO T 119                  | Per AASHTO   | Max. 8 inches or as approved by the Engineer   | Quality Control |
| Air Content (AC)  | AASHTO T 152                  | Per AASHTO   | $5\% \leq AC \leq 8\%$   | Quality Control |
| Temperature (°F)  | AASHTO T 309                  | Per AASHTO   | $50^{\circ}\text{F} \leq ^{\circ}\text{F} \leq 90^{\circ}\text{F}$                             | Quality Control |
| Compressive Strength <sup>(b)</sup>   | AASHTO T 22 AASHTO T 23       | 28-day Cylinders:<br>One (1) set of Three<br>(3) 4 x 8 in. | Lab Mixed $f'_{cr} = 1.3 f'_c$<br>at 28 days<br>Batch Mixed $f'_{cr} = 1.2 f'_c$<br>at 28 days | MassDOT         |
| Alkali-Silica Reaction (ASR) <sup>(d)</sup>                                       | ASTM C 1567                   | Per ASTM   | M4.02.00   | Quality Control |
| Resistance to Chloride Ion Penetration<br>Chloride Ion Penetration <sup>(e)</sup> | AASHTO T 358 <sup>(f)</sup>   | 28-day Cylinders:<br>One (1) set of Three<br>(3) 4 x 8 in. | Resistivity $\geq 21 \text{ k}\Omega\text{-cm}$<br>at 28 days                                  | MassDOT         |
| Freeze/Thaw Durability <sup>(c)</sup>   | AASHTO T 161<br>(Procedure A) | Per AASHTO   | Relative Dynamic Modulus of Elasticity after 300 cycles $\geq 80\%$                            | Quality Control |

**ITEM 995.** (Continued)**Notes:**

- a) Self-consolidating concrete (SCC) shall meet the requirements of M4.02.17.
- b) Trial batch compressive strength testing shall be performed by MassDOT. Laboratory mixed trial batch compressive strength results shall achieve 130% Design Strength ( $f'_c$ ). Batch-mixed trial batch compressive results shall achieve 120%  $f'_c$ . Acceptance will be based on compressive strength testing performed by MassDOT.
- c) If an AASHTO accredited laboratory is preparing the trial batch test specimens, MassDOT Acceptance presence is not required. If the Fabricator is preparing the trial batch test specimens, MassDOT Acceptance presence is required during trial batch test specimen preparation.
- d) Alkali Silica Reaction (ASR) testing shall meet the requirements of M4.02.00. Independent laboratories performing ASR testing shall be listed on the MassDOT Quality Construction Materials List (QCML).
- e) Calcium nitrite shall be removed from mix designs containing the admixture and replaced by an equivalent quantity of water when preparing Chloride Ion Penetration resistance trial batch test specimens.
- f) The Wenner probe tip spacing "a" shall be 1.5.

**2. Vertical Adjustment Assembly.**

Vertical Adjustment Assembly details and material requirements shall be as shown on the plans. Alternate devices may be used provided that they are adjustable and can support the anticipated loads. The design of the leveling devices, with required calculations, shall be submitted to the Engineer of Record for approval.

**3. Grout.**

Grout used for shear keys, vertical adjustment assembly voids, and hand holes shall be in accordance with M4.04.0.

**4. Reinforcement.**

All reinforcing steel shall be coated Grade 60 unless otherwise noted on the plans. Mechanical reinforcing bar splicers shall be epoxy coated.

**5. Threaded Inserts.**

Threaded inserts are permissible to facilitate forming the keyway pours. Threaded inserts shall be hot dip galvanized or made of stainless steel. The number of threaded inserts shall be minimized, and the inserts shall not come in contact with the reinforcing steel.

**6. Corrugated Metal Pipe.**

Corrugated Metal Pipe to be used for forming voids as specified on the plans shall be fabricated from steel and shall have a protective metallic coating of zinc (galvanizing).



**ITEM 995.** (Continued)**CONSTRUCTION METHODS – PLANT FABRICATION****A. Shop Drawings.**

Prior to performing any work under this Section, the Contractor shall receive approval for all shop drawings for the Precast Concrete Bridge Element being worked on and any special

Contract requirements, provided that a complete shop drawing package is provided. The Contractor shall not order materials or begin work before receiving approved shop drawings. MassDOT will reject Precast Concrete Bridge Elements that deviate from the approved drawings or are fabricated prior to receiving written approval of the shop drawings. The Contractor shall bear full responsibility and costs for all materials ordered or work performed prior to the approval of the shop drawings or written authorization from MassDOT.

Contractor shall submit scaled shop drawings to the Engineer of Record for review and approval. Upon approval, the Engineer of Record will forward two (2) sets of scaled, full size (minimum 24x36”) paper copies of the Approved (or Approved As Noted) shop drawings to the MassDOT Director of Research and Materials. Calculations are not to be included in any submittal to the Research and Materials Section. An approval stamp shall appear on every shop drawing sheet. Wet-stamping or wet-signing is not required, provided that the stamp and reviewer name are legible. The Fabricator’s name and address shall appear on each sheet.

Resubmittal of “Approved as Noted” shop drawings is not required for minor revisions, provided that the correction can be clearly understood and is unambiguous without possibility of misinterpretation. Shop drawings with questions or comments that require a response and/or additional information from the Fabricator must be resubmitted.

Detailed shop drawings shall be prepared in accordance with the relevant provisions of Subsection 5.02 and shall, at a minimum, contain the following:

- a) Number and type and/or piece mark of the precast concrete bridge element including overall length, width and height.
- b) Skew angle.
- c) Location, size and geometry of all steel reinforcement, including mechanical reinforcing bar splicers to be used for connecting Precast Concrete Bridge Elements together in the field.
- d) Location and details of all inserts, anchors, Vertical Adjustment Assemblies, and any other items required to be cast into the Precast Concrete Bridge Elements (whether detailed on the plans by the Engineer of Record or provided for the Contractor's convenience). Precast Concrete Bridge Elements shall not be fired or drilled into for attachment purposes. All hardware shall be galvanized except as noted.
- e) Locations and details of the lifting devices, including supporting calculations, type and amount of any additional reinforcing required for lifting. The Fabricator shall design all lifting devices based on the no cracking criteria in Chapter 8 of the PCI Design Handbook (7<sup>th</sup> edition).
- f) The minimum compressive strength required prior to handling the precast concrete bridge element.

The shop drawings shall not include procedures for placement, finishing, and curing of concrete. These details shall be included in the Placement, Finishing and Curing Plan that is to be submitted to MassDOT Research and Materials Section as described under *Placement, Finishing, and Curing Plan*.

---

**ITEM 995.** (Continued)**B. Fabrication.**

All Precast Concrete Bridge Elements shall be fabricated in accordance with the latest edition of PCI MNL-116 as modified herein.

**C. Placement, Finishing and Curing Plan.**

At least 30 days prior to start of fabrication, the Contractor shall submit the Fabricator's proposed Placement, Finishing and Curing Plan to the Engineer for approval by MassDOT Research and Materials Section. This shall be an independent submittal, separate from the fabrication shop drawings. The Placement, Finishing and Curing Plan shall include the following:

- a) Method of Mixing
- b) Method of Placement
- c) Method of Consolidation
- d) Method of Finishing
- e) Method of Initial Curing
- f) Method of Intermediate Curing
- g) Method of Final Curing
- h) Moisture Retention Materials and Equipment (water spray equipment, saturated covers, sheet materials, liquid membrane-forming compounds, accelerated curing equipment, etc.)
- i) Cylinder Curing Methods, Location, and Environmental Control (temperature, humidity, etc.)
- j) Temperature Monitoring, Recording, and Reporting

**D. Dunnage Plan Shop Drawings.**

At least 30 days prior to the start of fabrication, the Contractor shall submit proposed Dunnage Plan Shop Drawings to the Engineer of Record for review and approval. This shall be an independent submittal, separate from the fabrication shop drawings. Upon approval, the Engineer of Record will forward two (2) sets of scaled, full size (minimum 24"x36") paper copies of the Approved (or Approved As Noted) Dunnage Plan to the MassDOT Director of Research and Materials. Calculations are not to be included in any submittal to the Research and Materials Section. The Dunnage Plan shall include the following:

- a) Proposed layout of the Precast Concrete Bridge Elements for storage in yard and during shipping
- b) Support and blocking point locations
- c) Support and blocking materials

**E. Pre-Production Meeting.**

The Contractor shall notify the MassDOT Research and Materials Section to determine if a pre-production meeting will be required to review the specification, shop drawings, curing plan, schedule, and discuss any specific requirements. The meeting shall be held prior to scheduling a MassDOT Inspector (refer to Section *Quality Assurance – Precast Concrete, C. Acceptance, A. Inspection*), and at least seven (7) days prior to the scheduled casting of any Precast Concrete Bridge Element or control section. The Contractor shall schedule the meeting, which shall include representatives of the Fabricator and MassDOT.

---

**ITEM 995.** (Continued)**F. Reinforcement.**

The reinforcing bars shall be installed in accordance with Section 901.62 of the Supplemental Specifications, including tolerances for cover and horizontal spacing of bars. Components of mechanical reinforcing bar splicers shall be set with the tolerances shown on the plans. The reinforcing bars and mechanical reinforcing bar splicers shall be assembled into a rigid cage that will maintain its shape in the form and which will not allow individual reinforcing bars to move during the placement of concrete. This cage shall be secured in the form so that the clearances to all faces of the concrete, as shown on the plans, shall be maintained.

Where reinforcing bars are to protrude from one Precast Concrete Bridge Element in order to mate with reinforcing bar splicers in a second precast concrete element, the fabricator shall set the reinforcing bars and the reinforcing bar splicers with a template in order to ensure proper fit up within the tolerances specified on the plans.

**G. Tolerances.**

Fabrication shall comply with tolerances specified on the plans. Tolerances for steel reinforcement placement shall be in accordance with 901.62. In the absence of specifications on the plans, tolerances shall comply with the latest version of the PCI MNL 135, Precast Tolerance Manual.

**H. Forms.**

Concrete shall be cast in rigidly constructed forms, which will maintain the Precast Concrete Bridge Elements within specified tolerances to the shapes, lines and dimensions shown on the approved fabrication drawings. Forms shall be constructed from flat, smooth, non-absorbent material and shall be sufficiently tight to prevent the leakage of the plastic concrete. When wood forms are used, all faces in contact with the concrete shall be laminated or coated with a non-absorbent material. All worn or damaged forms, which cause irregularities on the concrete surface or damage to the concrete during form removal, shall be repaired or replaced before being reused. Any defects or damage of more than "Category 2, Minor Defects" made to the concrete, due to form work, stripping or handling, shall be subject to repair or rejection, as defined in the *Repairs and Replacement* section. If threaded inserts are cast into the elements for support of formwork, the inserts shall be recessed a minimum of 1 inch and shall be plugged after use with a grout of the same color as that of the precast cement concrete.

**I. Mixing of Concrete.**

The concrete shall be proportioned and mixed in conformance with the Fabricator's MassDOT approved mix design and M4.02.10 Mixing and Delivery. Fabrication shall not occur without prior MassDOT mix design approval. The Fabricator shall provide copies of batch tickets to the MassDOT Plant Inspector. The MassDOT Plant Inspector will verify if the batch ticket quantities are within the tolerances of the Fabricator's MassDOT approved mix design.

**ITEM 995.** (Continued)**J. Placement of Concrete.**

Prior to the placement of concrete, the temperature of the forms shall be greater than or equal to 50°F. Quality Control inspection shall be performed by the Fabricator as specified in the *Fabricator Quality Control* section. Placement of the concrete shall not proceed until the MassDOT Plant Inspector is present to perform inspection and begin monitoring Fabricator Quality Control inspection activities, and is in compliance with specifications. The MassDOT Plant Inspector shall inspect and accept the placement of the reinforcing steel prior to the placement of concrete into the forms. The Fabricator shall verify all materials and equipment required for protecting and curing the concrete are readily available and meet the requirements of the *Final Curing Methods* section below. All items encased in the concrete shall be accurately placed in the position shown on the Plans and firmly held during the placing and setting of the concrete. Clearance from the forms shall be maintained by supports, spacers, or hangers and shall be of approved shape and dimension.

During placement, the concrete shall maintain a concrete temperature range between 50°F and 90°F. The Fabricator shall minimize the time to concrete placement (measured from start of mixing to completion of placement). In no event shall time to placement exceed 90 minutes. The Fabricator shall perform additional Quality Control sampling and testing on concrete that has been retempered with admixtures or hold-back water during the placement of the concrete as specified in the *Fabricator Quality Control* section above. Delays or shutdowns of over 30 minutes shall not be allowed during the continuous filling of individual forms.

**K. Consolidation of Concrete.**

Suitable means shall be used for placing concrete to prevent segregation or displacement of reinforcing steel or forms. The concrete shall be thoroughly consolidated by external or internal vibrators or a combination of both. Vibrators shall not be used to move concrete within the forms. Vibrators shall be used as specified in 901.63C and as required by the Engineer. Concrete shall be placed and consolidated in a way that minimizes the presence of surface voids or bug holes on the formed surfaces. When used, self-consolidating concrete (SCC) shall meet the requirements of M4.02.17.

**L. Finishing of Concrete.**

The finish of the Precast Concrete Bridge Elements shall be as indicated on the plans. Where Precast Concrete Bridge Elements have keyways for grout or closure pours, the surfaces of these shear keys shall be abrasive blasted prior to shipment. The Fabricator may utilize a surface retarder with water blast, sandblast, or a combination of both to achieve the desired keyway finish. At a minimum, the profile of the keyway surfaces shall be similar to that of 60 grit sand paper. The exposed reinforcing steel in the precast slab shall be protected from damage during the cleaning of the keyways. Damaged epoxy coating of steel reinforcement shall be repaired, and the reinforcing steel shall be cleaned as required by the Engineer.

The Fabricator shall permanently mark each precast concrete bridge element with its type and/or piece mark, date of casting, and supplier identification either by stamp markings in fresh concrete, waterproof paint, or other approved means on a surface that will not be exposed after assembly.

---

**ITEM 995.** (Continued)**M. Exposed Surfaces of Precast Concrete Bridge Elements.**

As soon as conditions permit, before the concrete has fully hardened, all dirt, laitance, and loose aggregate shall be removed from the exposed concrete surfaces. Contractor shall not allow foot traffic on the uncured concrete until it has reached sufficient strength to prevent damage.

**N. Exposed Surfaces of Closure Pour Shear Keys.**

The closure pour shear key cast in the sides of the beam flanges shall have an exposed aggregate finish. The closure pour reinforcing steel and its coating shall not be damaged by the process for creating the exposed aggregate surface. Fabricator may utilize a surface retarder with water blast, abrasive blast, or a combination of both to achieve the desired shear key finish. The abrasive blast shall use oil free compressed air. The profile of the shear key surfaces shall be similar to that of 60 grit sand paper.

**O. Initial Curing Methods.**

After the placement of concrete and prior to concrete finishing, the Fabricator shall initiate initial curing methods when the concrete surface begins to dry, to reduce moisture loss from the surface. Application of one or more of the following initial curing methods shall occur immediately after the bleed water sheen has disappeared.

**1. Fogging.**

Fogging nozzles shall atomize water into a fog-like mist. The fog spray shall be directed and remain visibly suspended above the concrete surface, to increase the humidity of the air and reduce the rate of evaporation. Water from fogging shall not be worked into the surface during finishing operations and shall be removed or allowed to evaporate prior to finishing.

**2. Liquid-applied Evaporation Reducers**

Evaporation reducers shall be sprayed onto the freshly placed concrete surface to produce an effective monomolecular film that reduces the risk of plastic-shrinkage cracking and rate of evaporation of the bleed water from the concrete surface. Evaporation reducers shall be applied in accordance with manufacturer's recommendations.

**P. Intermediate Curing Methods.**

The Fabricator shall initiate intermediate curing methods if concrete finishing has taken place prior to the concrete reaching final set. The freshly finished concrete surface shall be protected from moisture loss, by the continuation of initial curing methods (fogging and evaporation reducers) until final curing methods are applied or by the use of liquid membrane-forming curing compounds (see *Liquid Membrane-Forming Compounds for Curing* section).

**Q. Final Curing Methods.**

The Fabricator shall initiate and apply final curing methods to the concrete immediately after the following conditions are met:

- a) Completion of concrete finishing
- b) Final set of concrete
- c) Concrete has hardened sufficiently enough to prevent surface damage

**ITEM 995.** (Continued)

During fabrication of Precast Concrete Bridge Elements, the Fabricator shall maintain the required concrete temperature ranges throughout the entire duration of the final curing method cycle as specified herein. Controlled and gradual termination of the final curing method shall occur after all specified conditions are met. The concrete temperature shall be reduced at a rate not to exceed 36°F per hour until the concrete temperature is within 20°F of the ambient temperature outside of the final curing method enclosure. The Fabricator shall maintain a minimum concrete temperature of 40°F until 100% f<sub>c</sub> is attained (see *Handling and Storage* section below).

**1. Water Spray Curing.**

All exposed concrete surfaces shall remain moist with a continuous fine spray of water throughout the entire duration of the final curing method cycle (see *Table 4: Final Curing Method Cycle for Water Spray*).

**Table 4: Final Curing Method Cycle for Water Spray**

| Sustained Concrete Temperature | Final Curing Method Cycle Duration | Compressive Strength |
|--------------------------------|------------------------------------|----------------------|
| 50°F ≤ °F ≤ 90°F               | ≥ Five (5) days                    | ≥ 80% f <sub>c</sub> |

**2. Saturated Covers for Curing.**

All exposed concrete surfaces shall remain moist with a continuous application of saturated covers throughout the entire duration of the final curing method cycle (see *Table 5: Final Curing Method Cycle for Saturated Covers*). Saturated covers shall be allowed to dry thoroughly before removal to provide uniform, slow drying of the concrete surface.

**Table 5: Final Curing Method Cycle for Saturated Covers**

| Sustained Concrete Temperature | Final Curing Method Cycle Duration | Compressive Strength |
|--------------------------------|------------------------------------|----------------------|
| 50°F ≤ °F ≤ 90°F               | ≥ Three (3) days                   | ≥ 80% f <sub>c</sub> |

Saturated covers, such as burlap, cotton mats, and other coverings of absorbent materials shall meet the requirements of AASHTO M 182, Class 3. Saturated covers shall be in good condition, free from holes, tears, or other defects that would render it unsuitable for curing concrete. Saturated covers shall be dried to prevent mildew when storing. Prior to application, saturated covers shall be thoroughly rinsed in water and free of harmful substances that are deleterious or cause discoloration to the concrete. Saturated covers shall have sufficient thickness and proper positioning onto the concrete surface to maximize moisture retention.

Saturated covers shall contain a sufficient amount of moisture to prevent moisture loss from the surface of the concrete. Saturated covers shall be kept continuously moist so that a film of water remains on the concrete surface throughout the entire duration of the final curing method cycle. The Fabricator shall not permit the saturated covers to dry and absorb water from the concrete. Use of polyethylene film (see *Polyethylene Film* section) may be applied over the saturated cover to potentially decrease the need for continuous watering.

**ITEM 995.** (Continued)

## 3. Sheet Materials for Curing.

All exposed concrete surfaces shall remain moist with a continuous application of curing sheet materials throughout the entire duration of the final curing method cycle (see *Table 6: Final Curing Method Cycle for Curing Sheet Materials*).

**Table 6: Final Curing Method Cycle for Sheet Materials**

| Sustained Concrete Temperature | Final Curing Method Cycle Duration | Compressive Strength |
|--------------------------------|------------------------------------|----------------------|
| 50°F ≤ °F ≤ 90°F               | ≥ Three (3) days                   | ≥ 80% f <sub>c</sub> |

Sheet Materials used for curing, such as polyethylene film, white burlap-polyethylene sheeting, and reinforced paper shall meet the requirements of ASTM C171 and the specifications herein. Sheet materials shall inhibit moisture loss and reduce temperature rise in concrete exposed to radiation from the sun during the final curing method cycle. Adjoining covers shall overlap not less than 12 inches. All edges of the covers shall be secured to maintain a moist environment.

**(a) Polyethylene Film.**

Polyethylene film shall meet the requirements of ASTM C171, consist of a single sheet manufactured from polyethylene resins, be free of visible defects, and have a uniform appearance. Careful considerations shall be taken by the Fabricator to prevent the film from tearing during storage and application, so as to not disrupt the continuity of the film (polyethylene film reinforced with glass or other fibers is more durable and less likely to be torn). The Fabricator shall monitor the application of the film to prevent uneven spots from appearing (mottling) on the concrete surface, due to variations in temperature, moisture content, or both. The Fabricator shall prevent mottling from occurring on the concrete surface by applying additional water under the film or applying a combination of polyethylene film bonded to absorbent fabric to the concrete surface to retain and evenly distribute the moisture.

Immediately following final finishing, polyethylene film shall be placed over the surface of the fresh concrete surface, so as to not damage the surface of the concrete and shall be placed and weighted so that it remains in contact with the concrete throughout the entire duration of the final curing method cycle. The film shall extend beyond the edges of the concrete surface. The film shall be placed flat on the concrete surface, avoiding wrinkles, to minimize mottling. Edges of adjacent polyethylene film shall overlap a minimum of 6 inches and be tightly sealed with the use of sand, wood planks, pressure-sensitive tape, mastic, or glue to maintain close contact with the concrete surface, retain moisture, and prevent the formation of air pockets throughout the entire duration of the final curing method cycle.

**(b) White Burlap-Polyethylene Sheeting**

White burlap-polyethylene sheeting shall meet the requirements of ASTM C171, be securely bonded to the burlap so to avoid separation of the materials during handling and curing of the concrete, and be applied in the same manner as the polyethylene film.

**ITEM 995.** (Continued)**(c) Reinforced Impervious Paper.**

Reinforced impervious paper shall meet the requirements of ASTM C171, consist of two sheets of kraft paper cemented together with a bituminous adhesive and reinforced with embedded cords or strands of fiber running in both directions, and be white in color. Reinforced impervious paper shall be treated to prevent tearing when wetted and dried.

Reinforced impervious paper can be reused so long as it is effective in retaining moisture on the concrete surface. The Fabricator shall visually inspect the reinforced impervious paper for all holes, tears, and pin holes from deterioration of the paper through repeated use by holding the paper up to the light. The paper shall be discarded and prohibited from use when the moisture is no longer retained.

After the concrete has hardened sufficiently to prevent surface damage, the concrete surface shall be thoroughly wetted prior to the application of the reinforced impervious paper, and be applied in the same manner as the polyethylene film.

**4. Liquid Membrane-Forming Compounds for Curing.**

All exposed concrete surfaces shall remain moist with a continuous application of liquid membrane-forming compounds throughout the entire duration of the final curing method cycle (see *Table 7: Final Curing Method Cycle for Liquid Membrane-Forming Compounds*).

**Table 7: Final Curing Method Cycle for Liquid Membrane-Forming Compounds**

| Sustained Concrete Temperature | Final Curing Method Cycle Duration | Compressive Strength |
|--------------------------------|------------------------------------|----------------------|
| 50°F ≤ °F ≤ 90°F               | ≥ Seven (7) days                   | ≥ 80% f <sub>c</sub> |

Liquid membrane-forming compounds shall meet the requirements of ASTM C 1315, Type I, Class A and shall exhibit specific properties, such as alkali resistance, acid resistance, adhesion-promoting quality, and resistance to degradation by ultraviolet light, in addition to moisture-retention capabilities. Liquid membrane-forming compounds shall consist of waxes, resins, chlorinated rubber, or other materials to reduce evaporation of moisture from concrete. Liquid membrane-forming compounds shall be applied in accordance with the manufacturer's recommendations.

Liquid membrane-forming compounds shall be applied immediately after the disappearance of the surface water sheen following final finishing. All exposed surfaces shall be wetted immediately after form removal and kept moist to prevent absorption of the compound, allowing the curing membrane to remain on the concrete surface for proper membrane moisture retention. The concrete shall reach a uniformly damp appearance with no free water on the surface prior to the application of the compound.

If patching or finishing repairs are to be performed prior to the application of the compound, the Precast Concrete Bridge Element shall be covered temporarily with saturated covers until the repairs are completed and the compound is applied. Only areas being repaired shall be uncovered during this period. While the saturated covers are removed to facilitate the patching process, the work shall continue uninterrupted. If for any reason the work is interrupted, saturated covers shall be placed onto the uncovered concrete surface, until the work continues and is completed, at which time the curing compound shall be applied to the repaired area.



**ITEM 995.** (Continued)

Careful considerations shall be made by the Fabricator to determine if the evaporation rate is exceeding the rate of bleeding, thus causing the surface to appear dry even though bleeding is still occurring. Under such conditions, the application of liquid membrane-forming compounds to the concrete surface shall be delayed, in order to prevent bleed water from being sealed below the concrete surface and avert map cracking of the membrane films, reduction in moisture-retention capability, and reapplication of the compound. To diagnose and prevent this condition, the Fabricator shall place a transparent plastic sheet over a test area of the uncured and unfinished concrete surface and shall determine if any bleed water accumulates under the plastic.

The compound shall be applied in two applications at right angles to each other to ensure uniform and more complete coverage. On very deeply textured surfaces, the surface area to be treated shall be at least twice the surface area of a troweled or floated surface. In such cases, two separate applications may be needed, each at 200 ft<sup>2</sup>/gal., with the first being allowed to become tacky before the second is applied.

The curing compound shall be applied by power sprayer, using appropriate wands and nozzles with pressures between 25 and 100 psi. For very small areas such as repairs, the compound shall be applied with a wide, soft-bristled brush or paint roller. The compound shall be stirred or agitated before use and applied uniformly in accordance with the manufacturer's recommended rate. The Fabricator shall verify the application rates are in accordance with the manufacturer's recommended rate.

When the concrete surface is to receive paint, finishes, or toppings that require positive bond to the concrete, it is critical that the curing procedures and subsequent coatings, finishes, or toppings be compatible to achieve the required bond.

After the termination of the final curing method cycle has occurred, liquid membrane-forming compounds shall be removed by blast-cleaning from any concrete surface that is to receive paint, finishes, plastic concrete from secondary pour, grout, or any other toppings that require bonding to the concrete surface. These surfaces shall be further blast-cleaned to remove the cement matrix down to exposed aggregate to ensure proper bonding to the material. The method used to remove the curing compound shall not damage the reinforcement and coating. Compounds are prohibited on any concrete surface that will have a penetrating or coating type treatment such as a sealer, stain, or waterproofing membrane applied to it.

**5. Accelerated Curing.**

Accelerated curing shall use live steam or radiant heat with moisture in accordance with PCI MNL-116 as modified herein. The concrete temperature shall meet the maximum heat increase and cool down rates as specified herein. Concrete temperature monitoring shall meet the requirements of the *Temperature Monitoring* section. Excessive and fluctuating rates of heating and cooling shall be prohibited. The concrete temperature shall not exceed 158°F at any time. The Fabricator shall meet the following accelerated curing sequencing and requirements.

**(a) Initial Delay Period.**

The initial delay period shall be defined as the duration immediately following the placement of the concrete and the attainment of initial set of the concrete. The Fabricator shall determine the time of initial set in accordance with AASHTO T 197 specifications. Throughout the entire duration of the preset period, initial curing shall be implemented. The temperature increase period (see *Temperature Increase Period* section) shall not occur until initial set of the concrete is attained. During the initial delay period, the concrete temperature shall meet the following requirements:

**ITEM 995.** (Continued)

- i. Concrete temperature rate of increase shall not exceed 10°F per hour.
- ii. Total concrete temperature increase shall not exceed 40°F higher than the placement concrete temperature or 100°F, whichever is less

**(b) Temperature Increase Period.**

The temperature increase period shall be defined as the duration immediately following the completion of the initial delay period (after initial set) and immediately prior to the start of the constant maximum temperature period. Application of steam to the enclosure shall not occur until the initial delay period is complete. After the initial delay period is complete, all exposed concrete surfaces shall be cured in a moist environment where the concrete temperature increases at a rate not to exceed 36°F per hour.

**(c) Constant Maximum Temperature Period.**

The constant maximum temperature period shall be defined as the duration immediately following the completion of the temperature increase period and immediately prior to the start of the temperature decrease period. After the temperature increase period is complete, all exposed concrete surfaces shall be cured in a moist environment at a controlled and constant elevated temperature throughout the entire duration of the constant maximum temperature period. Termination of the constant maximum temperature period and the start of the termination decrease period shall occur after all specified conditions are met (see *Table 8: Constant Maximum Temperature Period*).

**Table 8: Constant Maximum Temperature Period**

| Sustained Concrete Temperature | Constant Maximum Temperature Period | Compressive Strength |
|--------------------------------|-------------------------------------|----------------------|
| 120°F ≤ °F ≤ 158°F             | 6 hrs ≤ Time ≤ 48 hrs               | ≥ 80% f <sub>c</sub> |

**(d) Temperature Decrease Period.**

After the constant maximum temperature period is complete, the concrete temperature shall be cured in a moist environment at a controlled and reduced rate not to exceed 36°F per hour until the concrete temperature is within 20°F of the ambient temperature outside of the curing enclosure.

**R. Stripping.**

The Fabricator shall not strip forms or handle the Precast Concrete Bridge Element until Quality Control compressive strength cylinders attain a minimum compressive strength of 80% Design Strength (f<sub>c</sub>) or the value indicated on the approved drawings has been achieved. After removal from the form, all exposed concrete surfaces shall continue to be cured in conformance with the *Final Curing Methods* sections until completion.

**ITEM 995.** (Continued)**S. Handling and Storage of Precast Concrete Bridge Elements.**

Precast Concrete Bridge Elements may be exposed to temperatures below freezing (32°F) when the chosen curing cycle has been completed, provided that the following conditions are met:

1. Precast Concrete Bridge Elements are protected from precipitation with polyethylene curing covers until 100%  $f'_c$  is attained
2. Precast Concrete Bridge Elements maintain a minimum concrete temperature of 40°F until 100%  $f'_c$  is attained

Precast Concrete Bridge Elements damaged during handling and storage will be repaired or replaced at MassDOT's direction at no cost to MassDOT. Precast Concrete Bridge Elements shall be lifted at the designated points by approved lifting devices embedded in the concrete and in accordance with proper lifting and handling procedures. Storage areas shall be smooth and well compacted to prevent damage due to differential settlement. Precast Concrete Bridge Elements shall be supported on the ground by means of continuous blocking, in accordance with the approved dunnage plan.

Precast Concrete Bridge Elements shall be loaded on a trailer with blocking as described above, in accordance with the approved dunnage plan. Shock-absorbing cushioning material shall be used at all bearing points during transportation of the Precast Concrete Bridge Elements. Blocking shall be provided at all locations of tie-down straps. Precast Concrete Bridge Elements stored prior to shipment shall be inspected by the Contractor prior to being delivered to the site to identify damage that would be cause for repair or rejection.

**T. Repairs and Replacement.**

In the event defects are identified, they shall be classified in the following categories and a non-conformance report (NCR) shall be filed if required. The NCR shall be submitted to MassDOT for review. Defects in all categories shall be documented by plant Quality Control personnel and made available to MassDOT upon request. Any required repairs shall utilize materials listed on the MassDOT QCML.

Where noted, defects shall be repaired according to the PCI Northeast Region Guidelines for Resolution of Non-Conformances in Precast Concrete Bridge Elements, Report Number PCINE-18-RNPCBE. Please note that reference to PCINE-18-RNPCBE is made for repair details only. In the case of conflicts with this Special Provision, this Special Provision shall govern.

**1. Category 1, Surface Defects.**

Category 1 defects do not need to be repaired, and an NCR does not need to be filed. Surface defects are defined as the following:

- (a) Surface voids or bug holes that are less than 5/8-inch in diameter and less than 1/4-inch deep, except when classified as Category 4
- (b) Cracks less than or equal to 0.006 inches wide
- (c) Cracks less than or equal to 0.125 inches wide on surfaces that will receive a field-cast concrete overlay

**ITEM 995.** (Continued)**2. Category 2, Minor Defects.**

Category 2 defects shall be repaired, but an NCR does not need to be filed. Minor defects are defined as the following:

- (a) Spalls, honeycombing, surface voids that are less than 2 inches deep and have no dimension greater than 12 inches
- (b) Cracks less than or equal to 0.016 inches that will not receive a concrete overlay
- (c) Broken or spalled corners that will be covered by field-cast concrete

Minor defects shall be repaired according to PCINE-18-RNPCBE. Cracks shall be sealed according to the PCI Repair Procedure #14 in PCINE-18-RNPCBE.

**3. Category 3, Major Defects.**

For Category 3 defects, the Fabricator shall prepare an NCR that documents the defect and describes the proposed repair procedure. The NCR shall be submitted to MassDOT for approval prior to performing the repair. Major defects are defined as the following:

- (a) Spalls, honeycombing and surface voids that are deeper than 2 inches or have any dimension greater than 12 inches, when measured along a straight line
- (b) Concentrated area of defects consisting of four or more Category 2 Defects within a 4-square foot area.
- (c) Exposed reinforcing steel
- (d) Cracks greater than 0.016 inches and less than or equal to 0.060 inches in width that will not receive a concrete overlay
- (e) Bearing area spalls with dimensions not exceeding 3 inches
- (f) Cracks, spalls and honeycombing that will be encased in cast in place concrete need not be repaired, but the limits and location of the defects shall be documented with an NCR

Upon MassDOT approval, defects and cracks shall be repaired according to PCINE-18-RNPCBE and this specification. All repairs shall be completed at the expense of the Contractor.

**4. Category 4, Rejectable Defects.**

Rejectable defects as determined by the MassDOT Inspector, RMS, and Engineer may be cause for rejection. Fabricator may submit an NCR with a proposed repair procedure, requesting approval. Some rejectable defects are defined as the following:

- (a) Surface defects on more than 5% of the surface area which will be exposed to view after installation
- (b) Minor defects that in total make up more than 5% of the surface area of the unit
- (c) Cracks greater than 0.060 inches in width except as noted in Category 1
- (d) Elements fabricated outside of the specified tolerances
- (e) MassDOT compressive strength testing that does not meet the specified Design Strength,  $f'_c$

**ITEM 995.** (Continued)**U. Loading.**

Prior to the Fabricator loading the Precast Bridge Element on to the truck for shipping, the Fabricator shall provide the MassDOT Plant Inspector and RMS a minimum seven (7) days' notice of the Fabricator's intent to load the Precast Bridge Element. Inspection by the MassDOT Plant Inspector shall take place while the element is still on dunnage in the yard. The element shall not be loaded onto the truck until the MassDOT Plant Inspector has performed the inspection.

**V. Shipping.**

Prior to shipment, the Fabricator shall perform the following actions and provide the required documentation to the MassDOT Plant Inspector:

- a. Precast Concrete Bridge Elements shall remain at the Fabricator's plant for a minimum of 7 days after cast date.
- b. QC Inspection Reports shall be signed by the Quality Control Manager and provided to the MassDOT Plant Inspector.
- c. QC Compressive Strength Test Report Forms attaining Design Strength,  $f'c$  for the Precast Concrete Bridge Element's representative Sublot shall be generated by the Fabricator and provided to the MassDOT Plant Inspector.
- d. Certificate of Compliance shall be generated by the Fabricator as described under the Fabricator Quality Control section and provided to the MassDOT Plant Inspector.
- e. All MassDOT RMS approved Corrective Actions submitted on the Non-Conformance Reports (NCR), shall be verified to have been completed by the MassDOT Plant Inspector and Quality Control Manager.
- f. All NCRs shall be signed off by the Quality Control Manager, MassDOT Inspector and MassDOT RMS.

**W. Delivery.**

Upon Delivery, the following documentation shall be provided to the MassDOT Resident Engineer or designee:

- a. QC Compressive Strength Test Report Forms attaining Design Strength,  $f'c$  for the Precast Concrete Bridge Element's representative subplot.
- b. Certificate of Compliance generated by the Fabricator as described under the Fabricator Quality Control section.
- c. QC Inspection Reports signed by the Quality Control Manager.

The Contractor shall inspect Precast Concrete Bridge Elements upon receipt at the site. Precast Concrete Bridge Elements damaged during delivery shall be repaired or replaced at MassDOT's direction at no cost to MassDOT.

**ITEM 995.** (Continued)**CONSTRUCTION METHODS – FIELD CONSTRUCTION****A. General.**

All of the Contractor's field personnel involved in the erection and assembly of the Precast Concrete Bridge Elements shall have knowledge of and follow the approved Erection Procedure.

Prior to installation, the following documentation shall be reviewed and confirmed by the MassDOT Resident Engineer or designee:

- a. QC Compressive Strength Test Report Forms attaining Design Strength,  $f'_c$  for the Precast Concrete Bridge Element's representative subplot.
- b. Certificate of Compliance generated by the Fabricator as described under the Fabricator Quality Control section.
- c. QC Inspection Reports signed by the Quality Control Manager.

Field construction staff shall verify that the Resident Engineer has accepted all Precast Concrete Bridge Elements prior to installation.

**B. Erection Procedure.**

Prior to the erection, the Contractor shall submit an Erection Procedure for approval by the Engineer. This submittal shall include computations and drawings for the transport, hoisting, erection and handling of the Precast Concrete Bridge Elements. The Erection Procedure shall be prepared and stamped by a Professional Engineer registered in the Commonwealth of Massachusetts with working knowledge of the Contractor's equipment, approved shop drawings, and materials to build the bridge. The Erection Procedure shall, at a minimum, include the following:

**1. Erection Procedure**

The Erection Procedure shall be prepared to conform to the requirements of 960.61, Erection and the applicable sections in Chapter 8 of the PCI Design Handbook (seventh edition) for handling, erection, and bracing requirements. At a minimum, the Erection Procedure shall provide:

- (a) Minimum concrete compressive strength for handling the Precast Concrete Bridge Elements.
- (b) Concrete stresses during handling, transport, and erection.
- (c) Crane capacities, pick radii, sling geometry, and lifting hardware.
- (d) Verification that the equipment can handle all pick loads and weights with the required factor of safety.
- (e) Evaluation of construction sequence and evaluation of any geometric conflicts in the lifting of the Precast Concrete Bridge Elements and setting them as shown on the plans.
- (f) Design of crane supports including verification of subgrade for support.
- (g) Location and design of all temporary bracing that will be required during erection.

Non-shrink grout and concrete materials, approved by the Engineer, shall be placed as shown on the plans. Fill joints, keyways, and voids, in strict accordance with the specifications and manufacturer's recommendations and instructions.

**ITEM 995.** (Continued)

For footings, approach slabs and highway guardrail transitions, once these Precast Concrete Bridge Elements have been set to the correct horizontal and vertical alignment, the void between them and the supporting soil shall be filled with Controlled Density Fill – Non-Excavatable to the limits as shown on the plans. Add additional grout ports in the footings to facilitate the bedding process if required.

Joints shall be filled flush to the top with non-shrink grout, and any vertical misalignment between adjacent elements shall be feathered out on a slope of 1 to 12.

Curing of grout or concrete shall be performed in strict accordance with the specifications and manufacturer's recommendations. Filling shall not be completed in cold weather when either the ambient temperature or the precast member's temperature is below the manufacturer's recommendation. No localized heating of either the precast members or of the air surrounding the element will be permitted in an attempt to reach application temperatures.

If the joints or voids are not filled within five days after the Precast Bridge Elements are erected, the Contractor shall cover and protect the openings from weather and debris until they are filled.

**C. Survey and Layout.**

Working points, working lines, and benchmark elevations shall be established prior to placement of all elements. The Contractor is responsible for field survey as required to complete the work. MassDOT reserves the right to perform additional independent survey. If discrepancies are found, the Contractor may be required to verify previous survey data.

**D. Preparation of Closure Pour Keyways.**

Immediately prior to erecting the Precast Concrete Bridge Elements, the closure pour shear keys shall be cleaned at the job site of all dust, dirt, carbonation, laitance, and other potentially detrimental materials which may interfere with the bonding of the closure pour concrete and precast concrete using a high-pressure water blast. The exposed reinforcing steel in the precast concrete shall be protected from damage during the cleaning of the keyways. Damaged epoxy coating of steel reinforcement shall be repaired, and the reinforcing steel shall be cleaned as required by the Engineer. The surfaces of the shear keys shall be wetted so that the surfaces shall have a Saturated Surface Dry (SSD) condition for at least 24 hours prior to the placement of the closure pour concrete.

**E. Erection.**

The elements shall be placed in the sequence and according to the methods outlined in the Erection Procedure. As the erection proceeds, the Contractor shall constantly monitor the assembly to ensure that the precast concrete bridge element is within proper horizontal and vertical location and tolerances prior to releasing it from the crane and setting the next unit. The Contractor may use shims to maintain proper setting tolerances.

The concrete elements shall be lifted only by the lifting devices, and the utmost care shall be taken to prevent distortion of the elements during handling, transportation or storage.

Suitable spreaders shall be used during lifting so that only a vertical pull will be made on the lifting device. A non-vertical lifting force may be permitted if prior written approval is given by the Engineer. This approval will be contingent on the Contractor demonstrating by calculations, prepared by a Professional Engineer registered in Massachusetts, that the elements will not be damaged by the non-vertical lifting force and by documentation that the capacity of the lifting devices is adequate for the non-vertical lifting force.

**ITEM 995.** (Continued)

Precast components shall be pre-bed with non-shrink grout thicker than shim stacks prior to placing other precast elements on top of them.

After all Precast Concrete Bridge Elements have been placed, the actual overall dimensions of the structure both horizontal and vertical, as laid out shall not deviate from the nominal dimensions shown on the plans beyond a tolerance of +0 inches and -1 inches. Once the layout of Precast Concrete Bridge Elements has been accepted by the Engineer, the Contractor shall cut all lifting devices off below the surfaces of the elements.

**F. Filling of Blockouts for Lifting Devices and Threaded inserts.**

If the blockouts in the Precast Concrete Bridge Elements where the lifting devices were located will be exposed and visible after assembly is complete, the Contractor shall fill these blockouts with Cement Mortar (M4.02.15) or grout.

After the formwork has been removed, all threaded inserts that have been cast into the precast concrete bridge deck for support of the formwork shall be filled with a grout of the same color as that of the precast concrete.

**LAMINATED ELASTOMERIC BEARING W/O ANCHOR BOLTS (151-200K)****DESCRIPTION OF WORK**

The work to be performed under this heading shall conform to the relevant provisions of Subsection M9.14.5 and the following:

**SUBMITTALS**

The Contractor shall submit to the Engineer for approval the following documents:

1. Prior to fabrication:
  - a. Written notification in accordance with M9.14.5
  - b. Shop drawings for approval in accordance with Section 5.02 of MassDOT's Supplemental Specifications to the Standard Specifications for Highways and Bridges.
    - i. Fabrication shall not begin until the Contractor receives written approval from the Department that the submitted shop drawings have been received.
2. Upon delivery of the bearing pads:
  - a. A Certificate of Compliance certifying that the elastomeric bearing pads meet the requirements of the contract specifications.
    - i. A Mill certificate and certificate of compliance for the steel laminates shall accompany the bearing pads.
  - b. Independent testing results as required below.
  - c. Additional elastomeric bearing pads for MassDOT Acceptance testing as required below.



**ITEM 995.** (Continued)**MATERIALS**

- Elastomer: The elastomeric compound shall be composed of 100% low temperature Grade 3 virgin crystallization resistant polychloroprene (neoprene).
- Steel Laminates: The steel laminates shall meet the requirements of AASHTO M 251.
- Internal Load Plates: The internal load plates shall conform to AASHTO M 270 Grade 36 or Grade 50.

**FABRICATORS**

The National Transportation Product Evaluation Program (NTPEP) shall find the bearing pad fabrication plant to be in compliance with the Elastomeric Bridge Bearing Pad Technical Committee Work Plan. Approved fabricators are listed on the MassDOT QCML.

**FABRICATION**

Bearing pads shall be fabricated in conformance with the “Method B” design method outlined in the AASHTO LRFD Bridge Design Specifications.

The bearing dimensions, including elastomer thickness and edge cover, number and thickness of steel reinforcing laminates, dimensions of load plates (if any), and the design shear modulus of the elastomer shall be as shown on the Plans.

The tolerances on the overall dimensions for the bearings shall be according to Table 2 of AASHTO M 251, except that the tolerance on the overall vertical dimension shall be limited to -0, +1/8” regardless of the design thickness.

**SAMPLING**

Sampling of bearing pads for testing shall be random and performed on a lot basis. Lots shall be divided into sublots of 10 bearings. Acceptance samples shall be independently tested as outlined below. For Verification samples taken by the Engineer at the project, the sampling rate shall be one randomly selected full size bearing pad of each size and type in accordance with Subsection M9.14.5. A lot shall be defined as the smallest number of bearings determined by the following criteria:

1. A lot shall not exceed a single contract quantity.
2. A lot shall consist of bearings of the same size and configuration.
3. A lot shall consist of bearings produced in a continuous manner from the same batch of elastomer and cured under the same conditions.

**ITEM 995.** (Continued)

All pads required for testing purposes in accordance with Subsection M9.14.5 of the Standard Specifications shall be considered as incidental to this item. The quantities listed in the Schedule of Basis for Partial Payment only include the number of bearings required for construction and do not include the additional bearings required for conformance and destructive testing as outlined herein.

**INDEPENDENT TESTING**

Independent testing shall be performed by a nationally recognized testing laboratory approved by the Engineer which shall provide certified test results. Each Lot of bearings as defined above shall be randomly sampled and tested at the frequency specified under Section 8.5 of AASHTO M 251. The minimum testing shall be in conformance with Sections 8 and 9 of M 251 as specified below:

1. Materials shall meet Section 4 of M 251.
2. Dimensions per Section 8.4 of M 251.
3. Elastomer per Section 8.6 of M 251.
4. Compressive Strain at maximum dead and live load (service) per Section 8.8.1 of M 251.
  - a. The compressive deflection of each bearing shall not exceed 10% of the design effective rubber thickness at a compressive load equal to the maximum design load.
5. Short Duration Compression Test per Section 8.8.2 of M 251.
6. Shear Modulus of the Elastomer per Section 8.9.1 of M 251.
  - a. The shear modulus shall be between 0.136 and 0.184 ksi.
7. Tensile Strength, Ultimate Elongation per ASTM D412.
8. Shear Bond Strength per ASTM D429.
9. Heat Resistance per ASTM D573.
10. Compression Set per ASTM D395.
11. Low Temperature Brittleness per ASTM D746 for Elastomer Grades 3.

**PACKAGING, HANDLING, AND STORAGE**

The bearing pads shall be packaged, handled and stored in accordance with Section 18.1.3 of the AASHTO LRFD Bridge Construction Specifications. On the top of each completed bearing it shall be clearly identified and marked in accordance with M 251 Section 7. In addition, a 1/32" deep direction arrow shall be inscribed into the bearing which will allow the bearing to be aligned with the up-station direction. All marks shall be permanent and be visible after the bearing is installed.

**INSTALLATION**

The bearing pads and bridge seat bearing areas shall conform to Section 901.65A(3).

**ITEM 995.** (Continued)**ACCEPTANCE**

Requirements for providing notification to the Department prior to the start of bearing pad production as well as the provisions for random sampling of the bearings by the Department at the job site for additional destructive testing shall be in accordance with M9.14.5 and this specification. The Department shall use the results of the Independent testing as well as their own testing in the Acceptance of the bearing pads.

**HOT DIP GALVANIZED COATING FOR NEW STRUCTURAL STEEL****A. General**

Fabricated steel shall be galvanized as indicated on the plans. All fabrication shall be completed prior to surface preparation and the application of any coating.

When grinding, drilling or any other operation produces steel turnings, filings, shavings, etc. the contractor shall completely clean all areas of all accumulation prior to the end of the work shift.

Locations of field applied studs shall require masking or removal of galvanizing and paint prior to welding.

The Engineer shall provisionally accept the shop coated items before shipment to the jobsite but final acceptance of the coating system will occur after erection of the coated items, and after all required repairs and coating application has been completed.

The Contractor shall be responsible for failure and damage of all applied coating. Failures include but are not limited to, visible corrosion, blistering, checking, cracking, or delamination (peeling) and loss of gloss and color of the coating system. Damage includes but is not limited to damage from installation or from external agents, such as scraping, vandalism, debris impacts, and collisions. The extent and method of repair must be approved by the Engineer.

**B. Galvanizing**

The following shall be hot dipped galvanized in accordance with Section M7 of these Specifications:

1. Members identified on the contract documents.
2. Diaphragms and utility supports.
3. All sole plates.

Galvanized members requiring shop fabrication and assembly shall be cut, welded, and/or drilled prior to galvanizing. Bearing members to be milled shall be galvanized prior to milling. A thin layer of a rust inhibitor shall be applied to the milled surface. Material to be painted shall not be quenched after galvanizing.

**ITEM 995.** (Continued)

Where material is required to be welded after galvanizing, the steel shall be masked 3 inches on each side of the weld center line. Prior to field welding the masked surface shall be cleaned in accordance with SSPC-SP11. After welding the area shall be repaired in accordance with ASTM A780 "Repair of Hot Dip Galvanizing" section 4.2.2, "Paints Containing Zinc Dust" and Annex 2. Repair paint shall meet M7.04.11 and application shall be in accordance with the manufacturer's recommendations.

Damaged galvanized surfaces shall be repaired in accordance with ASTM A780 "Repair of Hot Dip Galvanizing" section 4.2.2 Paints Containing Zinc Dust "High Zinc Dust Content". The paint shall be applied to achieve a minimum dry film thickness of 3 mils and not more than 5 mils. Repair paint shall meet M7.04.11 and application shall be in accordance with the manufacturer's recommendations.

The Contractor shall provide protection of the adjacent coating in areas that will be field welded. After welding, the weld areas shall be prepared in accordance with SSPC-SP-11.

**METAL BRIDGE RAILING**

The work to be done under this heading shall conform to the relevant provisions of Subsection 975 of the Standard Specifications and the following:

S3-TL4 Railing shall be galvanized and painted dark bronze (Federal Std. 595B Color No. 10045).

**SCHEDULE OF BASIS FOR PARTIAL PAYMENT**

Within 10 days after the Notice to Proceed, the Contractor shall submit on their proposal form a schedule of unit prices for the major component Sub-Items that make up Item 995. as well as their total bridge structure Lump Sum cost for Bridge Structure No. F-04-010 (1KR). The bridge structure Lump Sum breakdown quantities provided in the proposal form are estimated and not guaranteed. The total of all partial payments to the Contractor shall equal the Lump Sum contract price regardless of the accuracy of the quantities furnished by the Engineer for the individual bridge components. The cost of labor and materials for any Item not listed but required to complete the work shall be considered incidental to Item 995. and no further compensation will be allowed.

**ITEM 995.** (Continued)

| Sub-Item | Component   | Quantity | Unit | Unit Price | Total |
|----------|---|----------|------|------------|-------|
| 901.     | 4000 psi, 1.5 Inch., 565 Cement Concrete                    | 128      | CY   |            |       |
| 904.     | 4000 psi, 3/4 Inch, 610 Cement Concrete                     | 2        | CY   |            |       |
| 904.3    | 5000 psi, 3/4 Inch, 685 Hp Cement Concrete                  | 60       | CY   |            |       |
| 904.4    | 4000 psi, 3/4 Inch, 585 Hp Cement Concrete                  | 185      | CY   |            |       |
| 910.1    | Steel Reinforcement for Structures-<br>Epoxy Coated         | 61,000   | LB   |            |       |
| 910.4    | Mechanical Reinforcing Bar Splicer                          | 532      | EA   |            |       |
| 911.1    | Shear Connectors  | 2,592    | EA   |            |       |
| 912.4    | Drilled and Grouted #4 Dowels                               | 24       | EA   |            |       |
| 913.2    | Coring And Grouting Anchor Bolts                            | 36       | EA   |            |       |
| 914.     | Precast Concrete Highway<br>Guardrail Transition            | 3        | EA   |            |       |
| 922.4    | Laminated Elastomeric Bearing<br>W/O Anchor Bolts (151-200) | 9        | EA   |            |       |
| 960.13   | Structural Steel - Galvanized                               | 173,800  | LB   |            |       |
| 965.     | Membrane Waterproofing for Bridge Decks                     | 3,640    | SF   |            |       |
| 970.     | Damp-Proofing   | 1,980    | SF   |            |       |
| 971.     | Asphaltic Bridge Joint System                               | 74       | FT   |            |       |
| 975.1    | Metal Bridge Railing (3 Rail), Steel<br>(Type S3-TL4)       | 220      | FT   |            |       |

Total Cost of Item 995. =

The schedule on the proposal form applies only to Bridge Structure No. F-04-010 (1KR). Payment for similar materials and construction at locations other than at this bridge structure shall not be included under this Item. Sub-Item numbering is presented for information only in coordination with MassDOT Standard Nomenclature.

**END OF DOCUMENT**  
\*\*\*\*\*

THIS PAGE INTENTIONALLY LEFT BLANK

DOCUMENT A00802

# **DETAIL SHEETS**

THIS PAGE INTENTIONALLY LEFT BLANK



**THE COMMONWEALTH OF MASSACHUSETTS  
 MASSACHUSETTS DEPARTMENT OF TRANSPORTATION - HIGHWAY DIVISION  
 TEN PARK PLAZA - BOSTON, MA**

– PRELIMINARY ESTIMATE OF QUANTITIES – DETAIL SHEET –

**CITY:** FITCHBURG  
**YEAR:** 2023  
**CLASS:** PRINCIPLE ARTERIAL  
**ROAD:** ROUTE 31 OVER NORTH NASHUA RIVER

**TYPE OF PROJECT:** BRIDGE-CONSTRUCTION

|                                 |            |             |                                |            |            |
|---------------------------------|------------|-------------|--------------------------------|------------|------------|
| Unclassified Excavation         | <u>360</u> | Cubic Yard  | Class B Rock Excavation        | <u>150</u> | Cubic Yard |
| Bridge Excavation               | <u>683</u> | Cubic Yard  | Reinforced Concrete Excavation | <u>68</u>  | Cubic Yard |
| Class B Trench Excavation       | <u>460</u> | Cubic Yard  | Special Borrow                 | <u>64</u>  | Cubic Yard |
| Temporary Support of Excavation | <u>180</u> | Square Yard | Gravel Borrow                  | <u>168</u> | Cubic Yard |

**PROPOSED FULL DEPTH PAVEMENT CONSTRUCTION (RIVER STREET) (4,130 SF)**

**SURFACE COURSE:** 1.5" SUPERPAVE SURFACE COURSE - 9.5 POLYMER (SSC-9.5-P)  
 OVER ASPHALT EMULSION FOR TACK COAT (RS-1H) OVER

**INTERMEDIATE COURSE:** 1.5" SUPERPAVE INTERMEDIATE COURSE - 12.5 (SIC-12.5)  
 OVER ASPHALT EMULSION FOR TACK COAT (RS-1H) OVER

**BASE COURSE:** 5.0" SUPERPAVE BASE COURSE - 37.5 (SBC-37.5) OVER

**SUBBASE COURSE:** 4" DENSE GRADED CRUSHED STONE FOR SUB-BASE OVER  
 8" GRAVEL BORROW TYPE B OVER  
 SPECIAL BORROW COMPACTED IN 8" LIFTS

**PROPOSED FULL DEPTH PAVEMENT CONSTRUCTION  
 OVER APPROACH SLAB (1,080 SF)**

**SURFACE COURSE:** 1.5" SUPERPAVE SURFACE COURSE - 9.5 POLYMER (SSC-9.5-P)  
 OVER ASPHALT EMULSION FOR TACK COAT (RS-1H) OVER

**INTERMEDIATE COURSE:** 1.5" SUPERPAVE INTERMEDIATE COURSE - 12.5 (SIC-12.5)  
 OVER ASPHALT EMULSION FOR TACK COAT (RS-1H) OVER

**BASE COURSE:** 4.5" SUPERPAVE BASE COURSE - 37.5 (SBC-37.5) OVER  
 ASPHALT EMULSION FOR TACK COAT (RS-1H) OVER

**SUBBASE COURSE:** 10" CONCRETE SLAB

**PROPOSED BRIDGE SPAN PAVEMENT CONSTRUCTION (3,610 SF)**

SURFACE COURSE: 1.5" SUPERPAVE BRIDGE SURFACE COURSE - 9.5 (SSC-B-9.5)  
OVER ASPHALT EMULSION FOR TACK COAT (RS-1H) OVER

BASE COURSE: 1.5" SUPERPAVE BRIDGE PROTECTIVE COURSE - 9.5 (SPC-B-9.5)  
OVER ASPHALT EMULSION FOR TACK COAT (RS-1H)  
OVER SPRAY APPLIED MEMBRANE OVER

SUBBASE COURSE: BRIDGE DECK

**PROPOSED CEMENT CONCRETE SIDEWALK AND WHEELCHAIR RAMPS (503 SF)**

SURFACE COURSE: 4" CEMENT CONCRETE (AIR ENTRAINED 4000 PSI - 3/4" - 610  
LB.) OVER

BASE COURSE: 8" GRAVEL BORROW TYPE B  
\* CONSTRUCTION TOLERANCES OF 0.5%±  
FOR SIDEWALK CROSS SLOPES

**PROPOSED FULL DEPTH HOT MIX ASPHALT DRIVEWAY (711 SF)**

SURFACE COURSE: 1.5" SUPERPAVE SURFACE COURSE - 9.5 POLYMER (SSC-9.5-P)  
OVER ASPHALT EMULSION FOR TACK COAT (RS-1H) OVER

INTERMEDIATE COURSE: 2.5" SUPERPAVE INTERMEDIATE COURSE - 12.5 (SIC-12.5)

BASE COURSE: 8" GRAVEL BORROW TYPE B

**PROPOSED MILL & OVERLAY (532 SF)**

SURFACE COURSE: 1.5" SUPERPAVE SURFACE COURSE 9.5 POLYMER (SSC-9.5-P)  
OVER ASPHALT EMULSION FOR TACK COAT (RS-1H)

INTERMEDIATE COURSE: 2" SUPERPAVE INTERMEDIATE COURSE 12.5 (SIC-12.5) OVER  
ASPHALT EMULSION FOR TACK COAT (RS-1H)

MILLING: 3" PAVEMENT FINE MILLING

**ITEM 100.95**      **GEOTECHNICAL MONITORING AND INSTRUMENTATION**

For vibration monitoring of the existing substructure, 12" sewer under river, Crocker field wall, and adjacent properties during pile driving

**ITEM 100.99**      **TELEVISION INSPECTION OF SEWER PIPES**

For pre and post inspections of existing 12" sewer under the river and sewer service pipes within project limits

**ITEM 101.**      **CLEARING AND GRUBBING**

As needed to complete the work

SW Corner  
NE Corner

**ITEM 107.98**      **STONE MASONRY CRACK REPAIRS**

At existing north and south abutments. Quantity to be verified in field.

**ITEM 107.99**      **STONE MASONRY POINTING REPAIRS**

At existing north and south abutments. Quantity to be verified in field.

**ITEM 120.1**      **UNCLASSIFIED EXCAVATION**

To be used with excavation at proposed full depth pavement, sidewalks, wheelchair ramps, and driveways

**ITEM 127.1**      **REINFORCED CONCRETE EXCAVATION**

To be used with excavation at existing north and south abutments

**ITEM 140.**      **BRIDGE EXCAVATION**

To be used with excavation for abutments, guardrail transitions and flood wall reconstruction

**ITEM 141.1**      **TEST PIT FOR EXPLORATION**

2 Test Pits (one at each abutment approach)  
2 Test Pits at driveways where sewer bypass is in conflict with electric lines

**ITEM 142.**      **CLASS B TRENCH EXCAVATION**

For new 60" drainage pipe

| <u>STATION</u>        | <u>OFFSET</u> |
|-----------------------|---------------|
| STA 22+44.78 to 22+65 | LT            |

**ITEM 144.**      **CLASS B ROCK EXCAVATION**

To be used at excavations where rock is encountered.  
Quantity is an assumed percentage of Items 140. and 141.

**ITEM 145.**      **DRAINAGE STRUCTURE ABANDONED**

| <u>STATION</u> | <u>OFFSET</u> |
|----------------|---------------|
| 22+48.45       | LT            |

**ITEM 146.**      **DRAINAGE STRUCTURE REMOVED**

| <u>STATION</u> | <u>OFFSET</u> |
|----------------|---------------|
| 22+76          | RT            |
| 22+44          | LT            |

**ITEM 150.1**      **SPECIAL BORROW**

At Full Depth Pavement to adjust subgrade elevation  
North of Bridge Sta 22+20 to 22+56  
South of Bridge Sta 23+93 to 24+31

**ITEM 151.**      **GRAVEL BORROW**

For subbase and fill material throughout the project, including for sidewalk, pedestrian curb ramp, driveway, and granite curb construction.  
For subbase at full depth pavement  
For profile adjustment in full depth areas For subbase at full depth widening  
For subbase at sidewalks  
For subbase at PCRs and dwys  
For setting curb

**ITEM 151.1**      **GRAVEL BORROW FOR BRIDGE FOUNDATION**

To be used behind integral abutments, flood wall reconstruction and at test pit locations

**ITEM 153.1**      **CONTROLLED DENSITY FILL - NON-EXCAVATABLE**

Transition base NW, SW & NE. Use as required by the Engineer.

**ITEM 156.**      **CRUSHED STONE**

3/8" crushed stone in island between bridge and driveway at NW corner  
3/4" crushed stone under special manhole (see Item 203.)

**ITEM 156.13**      **CRUSHED STONE FOR INTEGRAL ABUTMENT PILES**

To be used at north and south abutments

**ITEM 170.**      **FINE GRADING AND COMPACTING - SUBGRADE AREA**

For grading and compacting subgrade throughout the project.  
At full depth pavement  
At cement concrete sidewalks  
At wheelchair ramps and driveways

**ITEM 182.1**      **INSPECTION AND TESTING FOR ASBESTOS**

Throughout the project to identify and test materials suspected of containing asbestos as required by the Engineer

**ITEM 182.21**      **REMOVAL OF ASBESTOS**

Contingency item for removal of asbestos if detected using Item 182.1

**ITEM 184.1**      **DISPOSAL OF TREATED WOOD PRODUCTS**

For disposal of treated existing wood products at utility supports under the existing bridge.

**ITEM 203.**      **SPECIAL MANHOLE**

| <u>STATION</u> | <u>OFFSET</u> |
|----------------|---------------|
| 22+47.90       | LT            |

**ITEM 210.02**      **SANITARY SEWER MANHOLE REMOVED**

| <u>STATION</u> | <u>OFFSET</u> |
|----------------|---------------|
| 22+29.93       | 37.41 RT      |

**ITEM 220. DRAINAGE STRUCTURE ADJUSTED**

For adjustments to finished grades where grade is changing by less than six inches.

| <u>STATION</u> | <u>OFFSET</u> |
|----------------|---------------|
| 22+43          | LT            |
| 22+28          | LT            |
| 22+59          | RT            |

**ITEM 220.7 SANITARY STRUCTURE ADJUSTED**

For adjustments to finished grades where grade is changing by less than six inches.

| <u>STATION</u> | <u>OFFSET</u> |
|----------------|---------------|
| 22+30.75       | RT            |

**ITEM 220.8 SANITARY STRUCTURE REMODELED**

| <u>STATION</u> | <u>OFFSET</u> |
|----------------|---------------|
| 22+09.91       | 45.93 RT      |

**ITEM 222.3 FRAME AND GRATE (OR COVER) MUNICIPAL STANDARD**

| <u>STATION</u> | <u>OFFSET</u> |
|----------------|---------------|
| 22+48          | LT            |
| 22+09.91       | RT            |

**ITEM 227.31 REMOVAL OF DRAINAGE PIPE SEDIMENT**

For cleaning drainage pipes in project area.  
Exist DMH (Sta. 22+43 LT) to Existing Outfall (Sta. 22+67 LT)  
Temp Drain connection to Exist DMH (Sta. 23+51 LT)

**ITEM 227.4 MASONRY PLUG**

At temporary drainage pipe connection to special manhole (see Item 203.)

**ITEM 230.9 SANITARY SEWER TEMPORARY BYPASS**

Temporary bypass for sanitary sewer. 22+30 to 26+55

**ITEM 252.60**      **60 INCH CORRUGATED PLASTIC PIPE**

Drainage line

**ITEM 302.10**      **10 INCH DUCTILE IRON WATER PIPE (RUBBER GASKET)**

Water line

|               |             |
|---------------|-------------|
| BEGIN STATION | END STATION |
| 21+95         | 24+36       |

**ITEM 309.**      **DUCTILE IRON FITTINGS FOR WATER PIPE**

For new bends, restraint joints, caps, and coupling (see Item 302.10)

**ITEM 350.10**      **10 INCH GATE AND GATE BOX**

| <u>STATION</u> | <u>OFFSET</u> |
|----------------|---------------|
| 22+16          | LT            |
| 22+49          | RT            |
| 24+02          | RT            |
| 24+26          | LT            |

**ITEM 367.10**      **10 INCH CAST IRON PLUG**

Temporary plug at proposed water main after Phase 1B construction

STATION  
STA 24+18  
STA 22+39

**ITEM 373.10**      **10 INCH WATER PIPE INSULATION**

For new water line

|                      |                    |
|----------------------|--------------------|
| <u>BEGIN STATION</u> | <u>END STATION</u> |
| 22+16                | 24+24              |

**ITEM 402.**      **DENSE GRADED CRUSHED STONE FOR SUB-BASE**

At Full Depth Pavement, North and South of Bridge

**ITEM 415.2**      **PAVEMENT FINE MILLING**

At areas of milling and overlay  
South of Bridge  
Driveway at SW corner of Bridge

**ITEM 450.221**      **SUPERPAVE SURFACE COURSE - 9.5 POLYMER (SSC-9.5-P)**  
**ITEM 450.31**      **SUPERPAVE INTERMEDIATE COURSE - 12.5 (SIC-12.5)**

At full depth pavement  
North of Bridge      Sta 22+20 to 22+56  
South of Bridge      Sta 23+93 to 24+31

At approach slabs  
North of Bridge      Sta 22+56 to 22+72  
South of Bridge      Sta 23+75 to 23+92

At driveways in the NW and SW corners of Bridge

At areas of milling and overlay (excluding driveways)

**ITEM 450.42**      **SUPERPAVE BASE COURSE - 37.5 (SBC-37.5)**

At full depth pavement  
North of Bridge      Sta 22+20 to 22+56  
South of Bridge      Sta 23+93 to 24+31

At approach slabs  
North of Bridge      Sta 22+56 to 22+72  
South of Bridge      Sta 23+75 to 23+92

At driveways in the NW and SW corners of Bridge

**ITEM 450.60**      **SUPERPAVE BRIDGE SURFACE COURSE - 9.5 (SSC-B-9.5)**  
**ITEM 450.70**      **SUPERPAVE BRIDGE PROTECTIVE COURSE - 9.5 (SPC-B-9.5)**

Bridge Deck

**ITEM 451.**      **HMA FOR PATCHING**

As needed for patching areas of unsound pavement in areas of milling and overlay



**ITEM 485.001**      **COBBLESTONE ROTARY FEATURE**

| <u>BEGIN STA</u> | <u>END STA</u> |                  |
|------------------|----------------|------------------|
| STA 22+03        | STA 22+35      | NE ISLAND        |
| STA 22+46        | STA 22+59      | NE ISLAND        |
| STA 22+25        | STA 22+36      | MIDDLE ISLAND    |
| STA 22+48        | STA 22+72      | MIDDLE ISLAND    |
| STA 22+10        | STA 22+15      | NW MIDDLE ISLAND |

**ITEM 504.**      **GRANITE CURB TYPE VA4 - STRAIGHT**

| <u>BEGIN STA</u> | <u>END STA</u> | <u>OFFSET</u> |
|------------------|----------------|---------------|
| STA 22+02        | STA 22+31      | LT            |
| STA 22+46        | STA 22+55      | RT            |
| STA 22+53        | STA 22+55      | RT            |
| STA 22+53        | STA 22+65      | LT            |
| STA 22+77        | STA 22+92      | RT            |
| STA 22+71        | STA 22+75      | RT            |
| STA 23+70        | STA 23+85      | LT            |
| STA 24+07        | STA 24+14      | LT            |
| STA 23+97        | STA 23+98      | LT            |

**ITEM 504.1**      **GRANITE CURB TYPE VA4 - CURVED**

| <u>BEGIN STA</u> | <u>END STA</u> | <u>OFFSET</u> |
|------------------|----------------|---------------|
| STA 22+55        | STA 22+55      | RT            |
| STA 22+70        | STA 22+71      | RT            |
| STA 22+71        | STA 22+88      | RT            |
| STA 23+84        | STA 23+88      | RT            |

**ITEM 509.**      **GRANITE TRANSITION CURB FOR PEDESTRIAN CURB  
RAMPS – STRAIGHT**

Transition for PCR/DWYs w/ straight curb

| <u>BEGIN STA</u> | <u>END STA</u> | <u>DESCRIPTION</u> |
|------------------|----------------|--------------------|
| STA 22+45        | STA 22+52      | FOR PCR 4          |
| STA 22+72        | STA 22+79      | FOR PCR 2          |
| STA 22+31        | STA 22+37      | FOR PCR 1          |
| STA 22+42        | STA 22+53      | FOR PCR 1          |
| STA 23+86        | STA 23+90      | FOR DWY 2          |
| STA 24+03        | STA 24+07      | FOR DWY 2          |
| STA 24+29        | STA 24+36      | FOR DWY 1          |

**ITEM 509.1**      **GRANITE TRANSITION CURB FOR PEDESTRIAN CURB RAMPS - CURVED**

Transition for PCR/DWYs w/ curved curb

| <u>BEGIN STA</u> | <u>END STA</u> | <u>OFFSET</u> |
|------------------|----------------|---------------|
| 22+54            | 22+56          | RT            |
| 22+71            | 22+72          | RT            |
| 22+90            | 23+92          | RT            |
| 24+00            | 24+03          | LT            |

**ITEM 521.**      **CONCRETE CURB CORNER TYPE A**

| <u>STATION</u> | <u>OFFSET</u> |
|----------------|---------------|
| 23+97          | LT            |

**ITEM 580.**      **CURB REMOVED AND RESET**

| <u>STATION</u> | <u>OFFSET</u>  |
|----------------|----------------|
| 22+46          | RT             |
| 23+80          | RT             |
| 23+96          | both RT and LT |

**ITEM 582.**      **CURB CORNER REMOVED AND RESET**

| <u>STATION</u> | <u>OFFSET</u> |        |
|----------------|---------------|--------|
| 22+55.00       | RT            | NW DWY |
| 22+78.76       | RT            | NW DWY |

**ITEM 628.314**      **TEMPORARY IMPACT ATTENUATOR, REDIRECTIVE, TL-2**

TMPS Phase 1 Sta 22+32.73 LT  
 TMPS Phase 2 Sta 22+32.73 RT

**ITEM 628.4**      **TEMPORARY IMPACT ATTENUATOR, REMOVED AND RESET**

To be used when work moves from Phase 1 to Phase 2

**ITEM 645.148**      **48 INCH CHAIN LINK FENCE (PIPE TOP RAIL) VINYL COATED (LINE POST OPTION)**

| <u>STATION</u> | <u>OFFSET</u> |                   |
|----------------|---------------|-------------------|
| 23+79.90       | LT            | Fence along river |

**ITEM 657.5**      **TEMPORARY FENCE REMOVED AND RESET**

To be used when work moves from Phase 1 to Phase 2

**ITEM 697.1**      **SILT SACK**

| <u>STATION</u> | <u>OFFSET</u> |
|----------------|---------------|
| 22+02          | LT            |
| 22+28          | LT            |
| 22+59          | RT            |

**ITEM 701.**      **CEMENT CONCRETE SIDEWALK**

| <u>STATION</u> | <u>OFFSET</u> |
|----------------|---------------|
| 22+44.34       | RT            |
| 22+49.50       | RT            |
| 22+52.30       | LT            |
| 23+83.08       | LT            |

**ITEM 701.1**      **CEMENT CONCRETE SIDEWALK AT DRIVEWAYS**

| <u>STATION</u> | <u>OFFSET</u> |
|----------------|---------------|
| 23+97          | LT            |

**ITEM 701.2**      **CEMENT CONCRETE PEDESTRIAN CURB RAMP**

| <u>STATION</u> | <u>OFFSET</u> |
|----------------|---------------|
| 23+96.19       | RT            |
| 22+70.52       | RT            |
| 22+55.60       | RT            |
| 22+40.30       | LT            |

**ITEM 710.4**      **BOUND - PLAIN GRANITE**

For new bound plain granite

| <u>STATION</u> | <u>OFFSET</u> |
|----------------|---------------|
| 24+13          | RT            |

**ITEM 711.**      **BOUND REMOVED AND RESET**

Existing bound to be removed and reset

| <u>STATION</u> | <u>OFFSET</u> |
|----------------|---------------|
| 22+72          | RT            |

**ITEM 751.1**      **LOAM FOR LAWNS**

STATION                      OFFSET  
Sta 22+24.35 to 22+71.30    LT

**ITEM 767.121**      **SEDIMENT CONTROL BARRIER**

NE Corner  
NW Corner  
SW Corner

**ITEM 801.44**      **4 INCH ELECTRICAL CONDUIT - TYPE NM (4 BANK)**

Temporary electrical conduit on utility bridge

STATION  
22+60 to 24+32

**ITEM 801.46**      **4 INCH ELECTRICAL CONDUIT - TYPE NM (6 BANK)**

Proposed new electrical conduit

STATION  
22+27 to 24+42

**ITEM 812.13**      **LIGHT STANDARD FOUNDATION SD3.013**

STATION                      OFFSET  
22+58                          LT

**ITEM 812.30**      **STANDARD SIGNAL POST FOUNDATION SD3.030**

STATION                      OFFSET  
22+44                          LT

**ITEM 823.70**      **HIGHWAY LIGHTING POLE AND LUMINAIRE REMOVED AND RESET**

STATION                      OFFSET  
22+58                          LT

**ITEM 824.50**      **FLASHING WARNING BEACON REMOVED AND RESET**

STATION                      OFFSET  
22+44                          LT

**ITEM 866.106**      **6 INCH REFLECTORIZED WHITE LINE (THERMOPLASTIC)**

| <u>FROM STA.</u> | <u>TO STA.</u> | <u>DESCRIPTION</u> |
|------------------|----------------|--------------------|
| STA 23+44        | STA 24+76      | Solid White Line   |
| STA 23+42        | STA 24+44      | Solid White Line   |
| STA 22+45        | STA 22+79      | Solid White Line   |
| STA 22+45        | STA 22+76      | Solid White Line   |
| STA 22+02        | STA 22+35      | Solid White Line   |
| STA 22+25        | STA 22+35      | Solid White Line   |
| STA 22+10        | STA 22+15      | Solid White Line   |

**ITEM 867.106**      **6 INCH REFLECTORIZED YELLOW LINE (THERMOPLASTIC)**

| <u>STATION</u>      | <u>DESCRIPTION</u> |
|---------------------|--------------------|
| STA 22+79 STA 24+46 | Double Yellow Line |
| STA 22+25 STA 22+35 | Single Yellow Line |

**ITEM 874.2**      **TRAFFIC SIGN REMOVED AND RESET**

| <u>STATION</u> | <u>OFFSET</u> |
|----------------|---------------|
| 24+14.92       | RT            |
| 22+66.05       | RT            |
| 23+91.15       | LT            |

**ITEM 912.3**      **DRILLED & GROUTED #3 DOWELS**

Dowels to tie concrete slab in front of proposed abutments, to the existing abutments.

**ITEM 942.102**      **STEEL PILE HP 10 X 57**

North Abutment South Abutment

**ITEM 944.2**      **PRE-DRILLING FOR PILES**

North Abutment South Abutment

**ITEM 944.21**      **TEST PROBING FOR PILE OBSTRUCTIONS**

To be used at each pile location prior to pile driving to record information about potential obstructions

**ITEM 944.3**      **DRILLING FOR PILE OBSTRUCTIONS**

To be used to drill through pile obstructions recorded using Item 944.21

**ITEMS 948.41**      **DYNAMIC LOAD TEST BY CONTRACTOR**

1 at each Abutment

**ITEM 948.5**      **PILE SHOES**

At each pile

**ITEM 953.1**      **TEMPORARY SUPPORT OF EXCAVATION**

North and South approaches along stage construction line  
At Crocker Field Wall, as needed.  
At Dunkin Donuts parking lot  
At Car Keys driveway

**ITEM 987.31**      **SPECIAL SLOPE PAVING UNDER BRIDGE - CEMENT CONCRETE**

Concrete paving in front of North and south abutments. Quantity includes curtain walls.

**ITEM 989.2**      **REPAIRS TO CONCRETE**

To be used at concrete repairs above flood wall at NW quadrant of bridge

**ITEM 991.1**      **CONTROL OF WATER - STRUCTURE NO. F-04-010**

For control of water around excavated areas for pipes, abutments and the drainage outfall

**ITEM 992.3**      **TEMPORARY SUPPORTS FOR BRIDGE STRUCTURE**

Contractor designed deck cantilever support during Phase 1A

**ITEM 993.1**      **TEMPORARY BRIDGE NO. F-04-010T**

Contractor designed Temporary Utility Bridge during Phase 1A and 1B.

DOCUMENT A00807

# CITY OF FITCHBURG

## STANDARD SPECIFICATIONS

Section 02085 Polyvinyl Chloride Gravity Pipe and Fittings.....A00807-3 though 9

Section 02631 Precast Manholes and Catch Basins ..... A00807-10 through 20

Materials and Installation Specifications for  
Constructing Water Mains and Water Services ..... A00807-21 through 46

THIS PAGE INTENTIONALLY LEFT BLANK



SECTION 02085

POLYVINYL CHLORIDE GRAVITY PIPE AND FITTINGS

PART 1 - GENERAL

1.01 WORK INCLUDED:

This section covers the furnishing and installation of Polyvinyl Chloride (PVC) pipe and fittings, as indicated on the drawings and as specified herein.

1.02 RELATED WORK:

- A. Section 02252, SUPPORT OF EXCAVATION
- B. Section 02300, EARTHWORK
- C. Section 02518, TRACER TAPE
- D. Section 02631, PRECAST MANHOLES AND CATCH BASINS

1.03 REFERENCES:

- A. The following standards form a part of these specifications as referenced:

ASTM International (ASTM)

|      |       |   |
|------|-------|---|
| ASTM | D2321 | Recommended Practice for Underground Installation of Flexible Thermoplastic Sewer Pipe            |
| ASTM | D3034 | Specification for Type PSM Polyvinyl Chloride (PVC) Sewer Pipe and Fittings                       |
| ASTM | D3212 | Specification for Joints for Drain and Sewer Plastic Pipes Using Flexible Elastomeric Seals       |
| ASTM | F679  | Specification for Polyvinyl Chloride (PVC) Large Diameter Plastic Gravity Sewer Pipe and Fittings |

1.04 SUBMITTALS: IN ACCORDANCE WITH REQUIREMENTS OF SECTION 01330 SUBMITTALS, SUBMIT THE FOLLOWING:

Manufacturer's literature of the materials of this section.

## PART 2 - PRODUCTS

### 2.01 MATERIALS:

- A. PVC gravity sewer pipe 4-inches through 15-inches diameter shall conform to ASTM D3034. PVC gravity sewer pipe 18-inches through 60-inches diameter shall conform to ASTM F679. All PVC gravity sewer pipe shall have an SDR of 35 unless noted, and shall meet the specific requirements and exceptions to the aforementioned specifications that follow.
- B. One pipe bell consisting of an integral wall section with a solid cross section rubber ring, factory assembled, shall be furnished with each standard, random and short length of pipe. Rubber rings shall be provided to the requirements of ASTM D3212.
- C. The rubber ring shall be retained within the bell of the pipe by a precision formed groove or recess designed to resist fishmouthing or creeping during assembly of joints.
- D. Spigot pipe ends shall be supplied with bevels from the manufacturer to ensure proper insertion. Each spigot end shall have an "assembly stripe" imprinted thereon to which the bell end of the mated pipe will extend upon proper jointing of the two pipes.
- E. PVC fittings shall be provided with bell and/or spigot configurations with elastomeric gasket seals conforming to ASTM Specification D3212, "Joints for Drain and Sewer Plastic Pipe using Flexible Elastomeric Seals", and shall be compatible with that of the pipe. Bend fittings with spigot ends shorter than the pipe recess bells will not be allowed. The shorter spigot end would not allow proper seating of the spigot in the mating bell and would permit undesired contact between the mating bell and the outside of the fitting bell.
- F. All pipe delivered to the job site shall be accompanied by independent testing laboratory reports certifying that the pipe and fittings conform to the above-mentioned specifications. In addition, the pipe shall be subject to thorough inspection and tests, the right being reserved for the Engineer to apply such of the tests specified as he may from time to time deem necessary.
- G. All cutting of pipe shall be done with a machine suitable for cutting PVC pipe. Cut ends shall be beveled when recommended by the pipe manufacturer
- H. Design sizes for all sewer services proposed shall be approved by Fitchburg Wastewater Division and Engineering Division.
- I. Each length of pipe and fitting shall be marked with the nominal pipe size, manufacturer's name or trademark, and the PVC cell classification.
- J. Pipe exterior barrel section shall be smooth walled. Ribbed profile is not acceptable.
- K. Gaskets shall be manufactured of a continuous elastomeric ring which is oil resistant (Neoprene compound). The elastomeric gaskets shall be factory installed and securely locked in place with each length of pipe furnished.

- L. Pipe joints shall be tested by the manufacturer at his expense as specified in ASTM F 477. The test results shall be furnished to the Owner (Engineer) for at least two specimens of each size selected at random from the lot to be furnished for this Contract.
- M. Service fittings for 18-inch diameter and larger sewer main pipe shall be “Inserta Tee” as manufactured by Inserta Fittings Co., Hillsboro Oregon, or approved equal. All service fittings shall consist of a PVC hub, rubber gasketed sleeve connection, and a 316 stainless steel band, screw and housing. The gasketed PVC bell end shall accept pipe with SDR35, ASTM D 3034 or equivalent O.D. specification. The seal shall be air-tight.
- N. Main line fittings for 18-inch diameter and larger sewer main pipe shall be fabricated from pipe meeting the above specified pipe requirements. Fabricated miter joints shall be reinforced by fusion heat welding. The Contractor shall provide six (6) inch service fittings (“Inserta Tees”) on the proposed sewer main for the property service connection. A sharp hole saw shall be used to obtain a precise hole (as specified by the manufacturer) in the pipe.
- O. Service fitting for sewer main pipe less than 18-inch in diameter shall be as manufactured by the pipe supplier, shall have bell and spigot configuration compatible with that of the pipe, and have a locked rubber ring. The Contractor shall provide six (6) inch branch, wyes on the proposed sewer main for the property service connection. Watertight end caps shall be installed on the wye branch until the service connection is installed.

### PART 3 - EXECUTION

#### 3.01 INSTALLATION:

- A. Except as modified herein, installation of the PVC pipe shall be in accordance with ASTM D2321. Installation shall also be in accordance with the manufacturer’s pipe installation guide.
- B. Each pipe length shall be inspected before being laid to verify that it does not contain cracks, excessive discoloration, blisters, pitting, holes, foreign inclusions, or other injurious defects, and is straight. Pipe shall be laid to conform to the lines and grades indicated on the drawings or given by the Engineer. Each pipe shall be so laid as to form a close joint with the next adjoining pipe and bring the inverts continuously to the required grade.
- C. The pipe shall be supported by compacted crushed stone. Crushed stone shall be as specified under Section 02300, EARTHWORK.
- D. The pipe shall not be driven down to grade by striking it with a shovel handle, timber, rammer, or other unyielding object. When each pipe has been properly bedded, enough of the backfill material shall be placed and compacted between the pipe and the sides of the trench to hold the pipe in correct alignment.

- E. Before a joint is made, the pipe shall be checked to assure that a close joint with the next adjoining pipe has been maintained and that inverts are matched and conform to the required line and grade.
- F. For pipe placed on crushed stone, immediately after the joint is made, the jointing area shall be filled with suitable materials so placed and compacted that the ends of either pipe will not settle under backfill load.
- G. No pipe or fitting shall be permanently supported on saddles, blocking, or stones.
- H. Branches and fittings shall be laid by the Contractor as indicated on the drawings, and/or as required by the Engineer. Open ends of pipe and branches shall be closed with PVC caps furnished by the pipe manufacturer and secured in place with premolded gasket joints or as required by the Engineer.
- I. All pipe joints shall be made as nearly watertight as practicable. There shall be no visible leakage at the joints and there shall be no sand, silt, clay, or soil of any description entering the pipeline at the joints. Where there is evidence of water or soil entering the pipeline, connecting pipes, or structures, the defects shall be repaired to the satisfaction of the Engineer.
- J. The Contractor shall build a tight bulkhead in the pipeline where new work enters an existing sewer. This bulkhead shall remain in place until the Engineer authorizes its removal.
- K. Care shall be taken to prevent earth, water, and other materials from entering the pipe, and when pipe laying operations are suspended, the Contractor shall maintain a suitable stopper in the end of the pipe and also at openings for manholes.
- L. As soon as possible after the pipe and manholes are completed on any street, the Contractor shall flush out the new pipeline using a rubber ball ahead of the water, and none of the flushing water or debris shall be permitted to enter any existing sewer. After the pipelines are cleaned, and if the groundwater level is above the pipe the Engineer will examine the pipe for leaks. If any defective pipes or joints are discovered at this time, they shall be repaired at the Contractor's expense.
- M. The Contractor shall arrange for the delivery of the pipe sections at approved locations in the vicinity of that portion of the line in which the pipe section are to be laid. Pipes shall be stored in an approved, orderly manner so that there will be a minimum of rehandling from the storage area to the final position in the trench and so that there is a minimum obstruction and inconvenience to any kind of traffic.
- P. All pipe is to be loaded, unloaded, and stockpiled in strict conformance with the manufacturer's recommendations. Deliveries shall be scheduled so that the progress of the work is at no time delayed and also so that large quantities of pipe shall not be stored for excessive lengths of time. The Contractor shall provide slings, straps and/or other approved devices to provides satisfactory support of the pipe when it is lifter. Under no circumstances shall the pipe be dropped from trucks or in the trench.

- Q. In order to ensure minimum amount of movement or disturbance, no more than two lengths of pipe may be laid before backfilling to a minimum of twelve inches of the pipe
- R. Pipe shall be laid in the dry and at no time shall water in the trench be permitted to flow into the sewer pipe.
- S. Laying and jointing shall be in accordance with the manufacturer's instructions.
- T. The Contractor shall have on hand for each pipe-laying crew, the necessary tools, gauges mechanical saws, mechanical bevelers, etc., necessary to install the pipe.
- U. The length of the incoming and outgoing pipe at manholes shall be a maximum of 2'-0". Measurements shall be made from the outside of the manhole wall.
- V. No service fittings or wyes shall be backfilled before location measurements have been taken. The depth of cover from the road surface to the top of the fitting or wye and the distance from the downstream manhole shall be recorded.
- W. The Contractor shall establish bench marks along the route of the pipeline at convenient intervals for their reference in checking the pipe and manhole inverts and other elevations throughout the project
- X. During construction, the Contractor shall provide the Engineer at their request, all reasonable and necessary materials, opportunities, and assistance for setting stakes and making measurement, taking quantities and checking location of the work. Assistance shall include the furnishing of one or two workers as needed at intermittent times. The Contractor shall carefully preserve benchmarks, reference points and stakes. In cases of willful or careless destruction by his own workers, he will be charged with the resulting expense and shall be responsible for any mistakes or delay that may be cause by their unnecessary loss or disturbance.

### 3.02 QUALITY ASSURANCE

#### A. LEAKAGE TESTING:

1. On completion of a section of sewer, including building connections installed to the edge of curb, the Contractor shall clean and television inspect the section in accordance with Section 02440, SEWER CLEANING, INSPECTION, TESTING, AND SEALING and Section 02441, TELEVISION INSPECTION OF NEW PIPELINES at no additional cost to the owner. Television inspection shall be conducted during periods of high groundwater.
2. The Contractor shall be responsible for the satisfactory water-tightness of the entire section of the sewer. All PVC mainline pipe installed shall be pressure tested to ensure water-tightness. Should the Engineer determine that the sections inspected are unsatisfactory, the Contractor shall do all work required to locate and repair the defects and re-inspect as the Engineer may require without additional compensation.

3. Testing of pipe joints to identify defective joints shall be in accordance with Section 3.6, Joint Testing Procedure for Mainline Sewer and Laterals Connected to Manholes, of the latest edition of NASSCO Suggested Standard Specification for Pressure Testing and Grouting of Sewer Joints, Laterals and Lateral Connections (Using the Packer Method with Solution Grouts). Test pressure used shall be acceptable to the Engineer.
4. Pressure testing shall be equal to 0.5 psi per vertical foot of pipe depth plus 2 psi, however, test pressure shall not exceed 10 psi. Once the designated pressure in the isolated void is displayed on the meter of the control panel, the application of air pressure shall be stopped and a 15 second waiting period shall commence. If the void pressure drop is greater than 1.0 psi within 15 seconds, the joint will have failed the test and shall be repaired as the Engineer may require without additional compensation.
5. Electronic video equipment shall be capable of displaying and recording, at a minimum the following data for each pipe joint:
  - a) Project Identification
  - b) Date Recorded
  - c) Footage counter
  - d) Test Pressure
  - e) Sewer Reach Identification (Street, location, start MH and second MH).
6. A plan of the method for repairing any defects that are found shall be submitted to the Engineer for review.

**B. PIPE DEFLECTION MEASUREMENT AND IMPACT RESISTANCE:**

1. In accordance with ASTM D3034, no less than 90 days after completion of the PVC sewer pipe installation, the Contractor shall test the pipeline for deflection using a "go/no-go" deflection mandrel having a minimum of nine evenly spaced arms or prongs. The "go/no-go" gauge shall be hand pulled through all sections of the pipeline by the Contractor. The Contractor shall submit drawings of the "go/no-go" gauge to the Engineer for approval prior to testing. Complete dimensions of the gauge for each diameter of pipe to be tested shall be in accordance with ASTM D3034.
2. Any section of pipe found to exceed 5 percent deflection shall be deemed a failed pipe and shall be excavated and replaced by the Contractor at his own expense.
3. The gauge shall be pulled through the line by hand using a smooth and easy motion. If an obstruction is encountered, the Contractor shall pull lightly to see if the gauge will clear the obstruction. If the gauge will not clear the obstruction, record the distance from the manhole and pull the gauge back out.

4. Minimum pipe stiffness (F/delta Y) at 5 percent deflection shall be 46 psi for all sizes when tested in accordance with ASTM Method of Test D2412, "External Loading Properties of Plastic Pipe by Parallel-Plate Loading" for pipes less than 18-inch diameter.
5. Pipe (6" long section) shall be subjected to impact from a free falling tup (20-lb. Tup A.) in accordance with ASTM Method of Test D2444 for pipes less than 18-inch diameter. No visual cracking splitting of the waterway wall shall be evidenced when tested in accordance with ASTM D-2444 with a 20 lb. weight, tup A.

END OF SECTION

\\wse03.local\WSE\Projects\MA\Fitchburg MA\2210713 Des. Phase - CSO 010, 032, 045, 083 Separation-Rehabilitation\Specifications\DIVISION 2

10/26/2022

02085-7

SECTION 02631

PRECAST MANHOLES AND CATCH BASINS

PART 1 - GENERAL

1.01 WORK INCLUDED:

This Section covers all precast manholes and catch basins complete, including, but not limited to, bases, walls, cones, mortar, inverts, frames and covers.

1.02 RELATED WORK:

- A. Section 02300, EARTHWORK
- B. Section 02745, PAVING
- C. Section 03302, FIELD CONCRETE

1.03 SYSTEM DESCRIPTION:

- A. Precast sections shall conform in shape, size, dimensions, materials, and other respects to the details indicated on the drawings or as required by the Engineer.
- B. All manholes and catch basins shall have concrete bases. Concrete bases shall be precast unless otherwise specified. Invert channels shall be formed of brick and mortar upon the base.
- C. Catch basins shall have a 3-foot deep sump unless otherwise specified.
- D. Riser and cone sections shall be precast concrete.

1.04 REFERENCES:

- A. The following standards form a part of this specification as referenced:

ASTM International (ASTM)

|           |  |
|-----------|--|
| ASTM A48  | Gray Iron Castings                           |
| ASTM C32  | Sewer and Manhole Brick                      |
| ASTM C144 | Aggregate for Masonry Mortar                 |
| ASTM C207 | Hydrated Lime for Masonry Purposes           |
| ASTM C478 | Precast Reinforced Concrete Manhole Sections |



ASTM C923 Specification for Resilient Connectors Between Reinforced Concrete Manhole Structures and Pipes

ASTM C1244 Standard Test Method for Concrete Sewer Manholes by the Negative Air Pressure (Vacuum) Test.

American Association of State Highway and Transportation Officials (AASHTO)

AASHTO M198 Joints for Circular Concrete Sewer and Culvert Pipe Using Flexible Watertight Gaskets

Occupational Safety and Health Administration

OSHA 29 CFR 1910.27 Fall Prevention Protection

1.05 SUBMITTALS: IN ACCORDANCE WITH REQUIREMENTS OF SECTION 01330 SUBMITTALS, SUBMIT THE FOLLOWING:

- A. Manufacturer’s literature of the materials of this section.
- B. Test reports as required by the Engineer.

PART 2 - PRODUCTS

2.01 PRECAST CONCRETE SECTIONS:

- A. All precast concrete sections shall conform to PCI 116, CRSI “Manual of Standard Practice” and ASTM C478 with the following exceptions and additional requirements:
  1. The wall thickness of precast sections shall be as designated on the drawings, meeting the following minimum requirements:

| <u>Section Diameter (Inches)</u> | <u>Minimum Wall Thickness (Inches)</u> |
|----------------------------------|--|
| 48                               | 5                                      |
| 60                               | 6                                      |
| 72                               | 7                                      |
| 84                               | 8                                      |

2. Type II cement shall be used except as otherwise approved.
3. Sections shall be steam cured and shall not be shipped until at least five days after having been cast.
4. Minimum compressive strength of concrete shall be 5,000 psi at 28 days.

5. No more than two lift holes may be cast or drilled in each section.
  6. The date of manufacture and the name or trademark of the manufacturer shall be clearly marked on the inside of each precast section.
  7. Acceptance of the sections will be on the basis of material tests and inspection of the completed product.
  8. Circumferential steel reinforcement in walls and bases shall be a minimum of 0.12 sq. in./lin. ft. for 4-foot diameter sections and 0.15 sq. in./lin. ft. for 5- and 6-foot diameter sections. Reinforcing shall extend into tongue and groove.
  9. In the event of conflict between or among standards, the more stringent provision shall govern.
- B. Top sections shall be eccentric cones, except that precast reinforced concrete slabs shall be used where cover over the top of the pipe is less than 5 feet. Conical reducing sections shall have a wall thickness not less than 5-inches at the bottom and wall thickness of 8-inches at the top. Conical sections shall taper from a minimum of 48-inches diameter to 24 or 30-inches diameter at the top, as shown on the drawings.
- C. Except where insufficient depth of cover dictates the use of a shorter base, bases shall be a minimum of 4 feet in height.
- D. Slab top sections and flat riser sections (Grade Rings) shall conform to the contract drawings, with particular attention focused upon the reinforcing steel and be designed to meet or exceed a loading requirement of HS-20 plus the weight of the soil above.
- E. The tops of the bases shall be suitably shaped by means of accurate ring forms to receive the riser sections.
- F. Precast sections shall be manufactured to contain wall openings of the minimum size to receive the ends of the pipes, such openings being accurately set to conform with line and grade of the sewer or drain. Subsequent cutting or tampering in the field, for the purpose of creating new openings or altering existing openings, will not be permitted except as required by the Engineer.
- G. "Drop-over" or "Dog house" manholes shall be placed where indicated on the drawings. The Contractor shall accurately measure the diameter of the existing outlet pipe and inform the manufacturer of its size, so that the "Drop-over" type opening can be cut into the precast manhole base. The bottom shall be cast in place by the Contractor in accordance with Section 03302, FIELD CONCRETE. The invert channel shall be formed of brick and mortar, as specified in this specifications section. The sub-base shall be a compacted, level foundation of crushed stone, at least 12-inches thick, as specified in Section 02300 EARTHWORK, but shall vary to the depth necessary to reach sound undisturbed earth.

- H. The exterior surfaces of all precast manhole bases, walls, and cones shall be given a minimum of one shop coat of bituminous dampproofing.
- I. The Engineer reserves the right to reject any unsatisfactory precast section and the rejected unit shall be tagged and removed from the job site immediately.
- J. The Engineer may also require the testing of concrete sections as outlined under Physical Requirements in ASTM C478 with the Contractor bearing all testing costs.
- K. The inside clear diameter of the opening at the top of the cone or in the slab shall be 24 inches.
- L. Precast concrete bases shall be constructed and installed as shown on the Drawings. The thickness of the bottom slab of the precast bases shall not be less than the manhole barrel sections or top slab, whichever is greater.
- M. On 5-foot diameter manholes the transition from 5 feet to 4 feet shall take place at the cone section of the flat top.

2.02 BRICK MATERIALS:

- A. Brick shall be sound, hard, and uniformly burned brick, regular and uniform in shape and size, of compact texture, and satisfactory to the Engineer. Bricks shall comply with ASTM C32, for Grade SS, hard brick, except that the mean of five tests for absorption shall not exceed 8 percent by weight.
- B. Rejected brick shall be immediately removed from the work and brick satisfactory to the Engineer substituted.
- C. Mortar shall be composed of Portland cement, hydrated lime, and sand in which the volume of sand shall not exceed three times the sum of the volumes of cement and lime. The proportions of cement and lime shall be as required by the Engineer and may vary from 1:1/4 for dense hard-burned brick to 1:3/4 for softer brick. In general, mortar for Grade SS Brick shall be mixed in the volume proportions of 1:1/2:4-1/2; Portland cement to hydrated lime to sand.
- D. Cement shall be Type II Portland cement as specified for concrete masonry.
- E. Hydrated lime shall be Type S conforming to ASTM C207.
- F. The sand shall comply with ASTM C144 specifications for "Fine Aggregate," except that all of the sand shall pass a No. 8 sieve.
- G. Grade at the top of the precast manhole shall be as such as to allow a maximum 8 courses and a minimum of 4 courses of brickwork to bring the frame and cover to finish grade.

## 2.03 FRAMES, GRATES, COVERS AND STEPS:

- A. Castings shall be of good quality, strong, tough, even-grained cast iron, smooth, free from scale, lumps, blisters, sandholes, and defects of every nature which would render them unfit for the service for which they are intended. Contact surfaces of covers and frame seats shall be machined to prevent rocking of covers.
- B. All castings shall be thoroughly cleaned and may be subject to a careful hammer inspection at the Engineer's discretion.
- C. Castings shall be ASTM A48 Class 30B or better.
- D. The surface of the manhole covers shall have a diamond pattern with the cast words "SANITARY" or "STORM," whichever is appropriate. Manhole covers shall have the cast words "CITY OF FITCHBURG" in accordance with City standards.
- E. Sewer manhole covers with a 26-inch diameter shall be EJ No. 00211188. Drain manhole covers with a 26-inch diameter shall be EJ No.00211189. 26-inch manhole covers shall be used unless otherwise specified. Manhole frames with 24-inch openings (for 26-inch covers) shall be EJ No. 0226611, or approved equal. The sewer manhole frame and cover shall be 475 pounds minimum.
- F. Manhole frames with 32-inch covers for 30-inch openings shall be 500 pounds minimum by EJ, No. V-1419; Quality Water Products, Style 47; Neenah Foundry Co., R1740B or approved equal.
- G. Three flange catch basin frames with a 22-inch opening shall be 6-inches in height minimum. They shall be EJ No. 00554613, or approved equal.
- H. Four flange catch basin frames with a 22-inch opening shall be 6-inches in height minimum. They shall be EJ No. 00554611, or approved equal.
- I. Three flange double catch basin frames with two 22-inch openings shall be 8-inches in height minimum. They shall be EJ No. 00544813, or approved equal.
- J. Four flange double catch basin frames with two 22-inch openings shall be 8-inches in height minimum. They shall be EJ No. 00544811, or approved equal.
- K. Catch basin grates shall be 23-7/8-inch square with 2-5/16-inch openings and 2-inches in height minimum. They shall be EJ No. 00552035, or approved equal.
- L. Catch basin cascading grates shall be 23-7/8-inch square with 4-3/8-inch openings and 4-3/4-inches in height minimum at the grates, and 2-inches in height minimum at the edges of the cover. They shall be EJ No. 00552084, or approved equal.
- M. Catch basin frames set against curbing shall have three flanges only.

- N. Manhole steps shall conform to ASTM C478 requirements and shall be fabricated of either extruded aluminum or steel reinforced plastic. Steps shall be uniformly spaced at a maximum of 12-inches unless otherwise shown on the drawings.
- O. Installation of steps is not required in drain manholes.

2.04 SEWER MANHOLE ACCESSORIES:

- A. Gasket materials shall be top grade (100% solids, vulcanized) butyl rubber and shall meet or exceed AASHTO M-198.
- B. Couplings at the manhole-pipe interface shall be made with a rubber seal system meeting the requirements of ASTM C923 and recommended for this type of connection.
- C. Stubs installed as specified and indicated on the drawings shall be short pieces of the same class pipe as that entering the manhole and shall have either stoppers or end caps as shown on the drawings. Stoppers or end caps shall be especially designed for that application.

2.05 MANHOLE FALL PREVENTION SYSTEMS:

- A. Where manholes exceed 20 vertical feet from the proposed rim elevation to the invert, manholes shall be provided with a fall prevention system. Fall prevention systems shall be in accordance with OSHA requirement 29 CFR 1910.27 and as described herein and as indicated on the contract drawings.
- B. Carrier rail assembly shall be 1-5/16-inch O.D. by 1-inch ID Type 6061-T6 aluminum notched 0.875-inches by 0.875-inches by 5/32-inches at 6-inch centers; tapped 3/8-inches at 9-inch centers opposite notches.
- C. Manhole rung clamp assembly shall be constructed from 6061-T6 aluminum 11-inches long by 1.25-inches wide with 2 slots 7/16-inches by 1.25-inches at 9-inch centers and serrated on one side.
- D. Safety locking mechanism shall be cast of manganese bronze with stainless steel springs, and drop forged links and snap-locking pawl shall be minimum tensile strength of 110,000 psi. Roller bearing shall be killian type. Stainless steel springs shall comply with Military Specification QQ-W-423B.
- E. Safety harness shall be adjustable to fit waists 30-inch to 48-inch. Belt shall be nylon web equipped with 3 stainless steel 'D' rings.
- F. Fall prevention systems shall be manufactured by DBI/SALA, Safe Approach or approved equal.

## PART 3 - EXECUTION

### 3.01 INSTALLATION:

#### A. PRECAST SECTIONS:

1. Precast bases shall be supported on a compacted level foundation of crushed stone, as specified in Section 02300 EARTHWORK, at least 12-inches thick, but shall vary to the depth necessary to reach sound undisturbed earth.
2. Precast reinforced concrete sections shall be set vertical and with sections in true alignment.
3. Butyl rubber joint sealant such as Kent Seal No. 2 or an approved equal shall be installed between each concrete section. Catch basin sections do not require joint sealant if so indicated on the drawings.
4. All holes in sections used for handling the sections shall be thoroughly plugged with mortar. Mortar shall be one part cement to 1-1/2 parts sand, mixed slightly damp to the touch (just short of "balling"), hammered into the holes until it is dense and an excess of paste appears on the surface, and then finished smooth and flush with the adjoining surfaces.
5. Connections to precast structure shall be accomplished by using: a "Kor-n'-Seal" joint with a stainless steel clamp, and a "Lock-Joint Flexible Manhole Sleeve" shall be cast into the manhole base section with a stainless steel strap. A fixed connection at the precast structure shall not be allowed.
6. Provide other materials, not specifically described but required for a complete and proper installation, as selected by the Contractor, subject to the approval of the Engineer.

#### B. BRICK WORK:

1. Bricks shall be moistened by suitable means, as required, until they are neither so dry as to absorb water from the mortar nor so wet as to be slippery when laid.
2. Each brick shall be laid as a header in a full bed and joint of mortar without requiring subsequent grouting, flushing or filling, and shall be thoroughly bonded as directed.
3. The brick inverts shall conform accurately to the size of the adjoining pipes. Side inverts shall be curved and main inverts (where direction changes) shall be laid out in smooth curves of the longest possible radius which is tangent to the centerlines of adjoining pipe.

4. Brick for invert shall be laid on edge. Brick for table and grade adjustment shall be laid flat.
5. Table shall be constructed to an elevation even with the crown of the pipe. Brick invert widths shall not be less than the inside diameter of the connecting pipes. Table shall slope up from the crown of the pipe to the edge of the manhole.

C. CASTINGS:

1. Cast iron frames, grates and covers shall be as specified. The frames and covers shall be set by the Contractor to conform accurately to the grade of the finished pavement, existing ground surface, or as indicated on the drawings. Frames shall be adjusted to meet the street surface.
2. Cast iron manhole frames and covers not located in paved areas shall be set 6-inches above finished grade, at a height as required by the Engineer, or as indicated on the drawings. The top of the cone shall be built up with a minimum of 4 course and a maximum of 8 courses of brick and mortar used as headers for adjustment to final grade.
3. Frames shall be set concentric with the top of the concrete section and in a full bed of mortar so that the space between the top of the concrete section or brick headers and the bottom flange of the frame shall be completely filled and made watertight. A thick ring of mortar extending to the outer edge of the concrete shall be placed all around the bottom flange. The mortar shall be smoothly finished to be flush with the top of the flange and have a slight slope to shed water away from the frame.
4. Covers and/or grates shall be left in place in the frames, for safety reasons, except while work is being performed.
5. Any damaged/broken existing frames, covers, or grates to be removed as indicated on the drawings shall be properly disposed of by the Contractor. Sound frames, covers, and grates to be removed as indicated on the drawings shall be neatly stacked on wooden pallets in front of the salt shed at 301 Broad Street (City Department of Public Works), or a location designated by the City Department of Public Works.

D. ACCESSORIES:

1. Accessories shall be installed in accordance with manufacturer's instructions.
2. Stubs shall be set accurately to the dimensions indicated on the drawings. Stubs shall be sealed with suitable watertight plugs.

E. MANHOLE FALL PREVENTION SYSTEM:

Carrier rail shall extend from the manhole invert shelf to within 18-inches of finish grade. The rail and manhole rung clamp assembly shall be rigidly connected utilizing 3/8-inch stainless steel bolts. Assembly shall be clamped to manhole steps at 2-foot centers or as recommended by the manufacturer.

3.02 LEAKAGE TESTS:

A. Leakage tests shall be made by the Contractor and observed by the Engineer on each manhole. The test shall be by vacuum or by water exfiltration as described below:

B. VACUUM TEST:

1. The vacuum test shall be conducted in accordance with ASTM C1244. Test results will be judged by the length of time it takes for the applied vacuum to drop from 10 inches of mercury to 9 inches. If the time is less than that listed in Table 1 of ASTM C1244, the manhole will have failed the test. Test times from Table 1 are excerpted below.

TABLE 1

Minimum Test Times for Various Manhole Diameters

| Depth (Feet) | Diameter (Inches)      |    |     |
|--------------|------------------------|----|-----|
|              | 48                     | 60 | 72  |
|              | <u>Times (Seconds)</u> |    |     |
| 0-12         | 30                     | 39 | 49  |
| 12-16        | 40                     | 52 | 67  |
| 16-20        | 50                     | 65 | 81  |
| 20-24        | 59                     | 78 | 97  |
| 26-30        | 74                     | 98 | 121 |

2. If the manhole fails the initial test, the Contractor shall locate the leaks and make proper repairs. Leaks may be filled with a wet slurry of accepted quick setting material. If the manhole should again fail the vacuum test, additional repairs shall be made, and the manhole water tested as specified on the following page.



## C. WATER EXFILTRATION TEST:

1. After the manhole has been assembled in place, all lifting holes shall be filled and pointed with an approved non-shrinking mortar. All pipes and other openings into the manhole shall be suitably plugged and the plugs braced to prevent blow out. The test shall be made prior to placing the shelf and invert. If the groundwater table has been allowed to rise above the bottom of the manhole, it shall be lowered for the duration of the test.
2. The manhole shall be filled with water to the top of the cone section or to the opening in the flat top section. If the excavation has not been backfilled and observation indicates no visible leakage, that is, no water visibly moving down the surface of the manhole, the manhole may be considered to be satisfactorily water-tight. If the test, as described above, is unsatisfactory as determined by the Engineer or if the manhole excavation has been backfilled, the test shall be continued. A period of time may be permitted if the Contractor so wishes, to allow for absorption by the manhole. At the end of this period, the manhole shall be refilled to the top of the cone, if necessary, and a measuring time of at least 8 hours begun. At the end of the test period, the manhole shall be refilled to the top of the cone, measuring the volume of water added. This amount shall be extrapolated to a 24-hour loss rate and the leakage determined on the basis of depth. The leakage for each manhole shall not exceed one gallon per vertical foot for a 24-hour period. If the manhole fails this requirement, but the leakage does not exceed 3 gallons per vertical foot per day, repairs by approved methods may be made as required by the Engineer to bring the leakage within the allowable rate of one gallon per foot per day. Leakage due to a defective section or joint or exceeding the 3 gallon per vertical foot per day, shall be cause for rejection of the manhole. It shall be the Contractor's responsibility to uncover the rejected manhole as necessary and to disassemble, reconstruct or replace it as required by the Engineer. The manhole shall then be retested and, if satisfactory, interior joints shall be filled and pointed.
3. No adjustment in the leakage allowance will be made for unknown causes such as leaking plugs, absorption, etc. It shall be assumed that all loss of water during the test is a result of leaks through joints or through the concrete. Furthermore, the Contractor shall take any steps necessary to assure the Engineer that the water table is below the bottom of the manhole throughout the test.
4. If the groundwater table is above the highest joint in the manhole, and there is no leakage into the manhole, as determined by the Engineer, such a test can serve to evaluate water-tightness of the manhole. However, if the Engineer is not satisfied with the results, the Contractor shall lower the water table and carry out the test as described hereinbefore.

3.03 CLEANING:

All new manholes shall be thoroughly cleaned of all silt, debris and foreign matter of any kind, prior to final inspection.

END OF SECTION

\\wse03.local\WSE\Projects\MA\Fitchburg MA\2210713 Des. Phase - CSO 010, 032, 045, 083 Separation-Rehabilitation\Specifications\DIVISION 2



Proposal No. 607680-124171  
**CITY OF FITCHBURG**  
Division of Water Supply  
1200 Rindge Road  
Fitchburg, MA 01420

Water Supply  
Treatment  
Distribution  
Customer Service

Tel. 978-345-9616

**MATERIALS AND INSTALLATION  
SPECIFICATIONS  
FOR  
CONSTRUCTING WATER MAINS  
AND  
WATER SERVICES**

CITY OF FITCHBURG

SERVICE CONNECTIONS AND APPURTENANCES  
FITCHBURG, MA

PART 1 GENERAL

1.01 DESCRIPTION

- A. The Water Department has the right to set standards and to approve or disapprove all practices or materials proposed.
- B. This section of the specifications covers the furnishing and installation of new water service connections and the repair, replacement, and/or transfer of water service connections as shown on the drawings, as specified herein, and as directed by the Water Department.
- C. The locations of all new services will be established in the field by the Contractor and approved by the Water Department.
- D. The new water services shall include corporation stop at main; copper or polyethylene service pipe to the property line and a curb stop with box set at the property line. Service pipe beyond the property line is the responsibility of the Homeowner. It will be subject to Water Department approval and acceptance. Any existing service tie-overs shall be directed by the Water Department in the field.

1.02 REFERENCE STANDARDS

- A. ANSI A21.4/AWWA C104 - Cement Mortar Lining for Ductile Iron and Gray Iron Pipe and Fittings for Water.
- B. ANSI A21.10/AWWA C110 - Gray Iron and Ductile Iron Fittings, 3" through 48", for Water and Other Liquids.
- C. ANSI A21.11/AWWA C111 - Rubber Gasket Joints for Ductile Iron and Gray Iron Pressure Pipe and Fittings.
- D. ANSI A21.51/AWWA C151 - Ductile Iron Pipe.
- E. ANSI B.16 - Cast Iron Pipe Flanges and Flanged Fittings, Class 25, 125, 250 and 800.
- F. ASTM A126 - Gray Iron Castings for Valves, Flanges and Pipe Fittings.
- G. ASTM B62 - Composition Bronze or Ounce Metal Castings.
- H. ASTM D2321 - Underground Installation of Flexible Thermoplastic Sewer Pipe.
- I. AWWA C150 - Thickness Design for Ductile Iron Pipe
- J. AWWA C500 Gate Valves, 3-inch through 48-inch

- K. AWWA C502 - Dry Barrel Fire Hydrants.
- L. AWWA C504 - Rubber Seated Butterfly Valves
- M. AWWA C509 Resilient-Seated Gate Valves
- N. AWWA C550 Protective Interior Coatings for Valves and Hydrants.
- O. AWWA C600 - Installation of Ductile Iron Water Mains.
- P. AWWA C601 - Disinfecting Water Main.

1.03 DESIGN SIZE

- A. Design sizes for all water services proposed shall be approved by the Water Department.

1.04 SUBMITTALS

- A. Four sets of manufacturer's literature of the materials of this section shall be submitted to the Water Department for review and approval.

1.05 INSPECTION AND TESTING

- A. All pipe and fittings shall be inspected and tested at the foundry as required by the standard specifications to which the material is manufactured. The Supplier shall furnish in duplicate to the Water Department sworn certificates of such tests.
- B. In addition, the Water Department reserves the right to have any or all pipe, fittings and special casting inspected and/or tested by an independent service at either the manufacturer's plant or elsewhere.
- C. Pipes and fittings shall be subjected to a careful inspection and a hammer test at the time of delivery and/or unloading.

PART 2 PRODUCTS

2.01 SERVICE MATERIALS

- A. Copper Tubing

Tubing for buried water services, air vents and chlorination taps shall be continuous Type K annealed seamless copper water tubing with compression connection joints conforming to ASTM B88 Standard Specifications for Seamless Copper Water Tube or U.S. Federal Specification WW-T-799C for Tube, Copper, Seamless.

B. Polyethylene Tubing

Tubing for buried water services shall be designed for 200 psi minimum service and tested at 330 psi for 1,000 hours or greater. The tubing shall be copper O.D. size and be suitable for use with standard industry brass compression fittings without special adapters. Stainless steel insert stiffeners shall be provided for use with all compression joint connections. Locating Tape shall be placed over Polyethylene tubing before burial. Polyethylene tubing shall be sand encased.

C. Corporation Stops and Boxes

Corporation stops shall be of brass and shall be Red Hed, Mueller (no Mueller oraseal), Cambridge Brass, McDonald or Ford. Operating nut shall be 3/8" wide by 1½" long (no square head type). The inlet shall be CC thread and outlet shall have compression connections. Corporation stops shall **OPEN RIGHT**.

In any new installation or renewal of a water service, a Buffalo style valve box is required on the corporation stop. The box shall be set on a concrete block or flat stone. The elevation of the box top will be at the bottom of the base course of pavement.

D. Curb Stops and Boxes

1. Curb stops shall be of brass composition without drain and shall be Red Hed, Mueller ball valve (no Mueller oraseal), Cambridge Brass, or Ford. They shall be "T" head type. The inlet and outlet shall have compression connections. Curb stops shall **OPEN RIGHT**.
2. Each curb stop shall be provided with a cast iron box. The valve box shall be Buffalo top and slide type or approved equal. The curb box cover shall be cast iron and North American made. The cast iron box shall be the extension type with arch pattern. Inside diameter of upper section shall be at least 2-1/2" for 3/4" and 1" curb stops and shall be at least 3" for 1-1/2" and 2" curb stops. The top section shall be slide type, a minimum of 24" long. Bottom section shall be slide type, a minimum of 39" long. Curb boxes shall contain an extension rod with centering ring adapter with 1/2-inch solid shank head, shaft to be 5/8-inch carbon steel, 1-foot long, yoke to be ductile iron 5/16-inch stock, yoke pin brass or stainless steel. Centering ring shall fit a standard type Buffalo service box.
3. All required couplings shall be Red Hed, Mueller, Ford Quick Pak Cambridge Brass, McDonald or approved equal by the Water Department.

E. Pipe Saddles

All pipe saddles shall be double strap design.

2.02 WATER MAINS, VALVES AND APPURTENANCES MATERIALS

A. GENERAL

1. All water works materials included in this section shall conform to the requirements of the standard specifications referenced herein.
2. Pipe size shall be as shown in the table in Section 2.02.
3. All pipe materials and methods of jointing shall be as specified in this section.
4. Submit shop drawings for approval.

B. PIPE AND FITTINGS

1. Ductile Iron Pipe: Pipe shall be designed in accordance with AWWA C150 and shall conform to ANSI A21.51/AWWA C151, Class 52 and shall have push-on joints except that pipe installed in vaults shall have flanged ends conforming to ANSI B16.1. Pipe shall be double cement-lined with seal coat inside and out, conforming to ANSI A21.4/AWWA C104. Push-on joints and rubber gaskets shall be in accordance with ANSI A21.11/AWWA C111.
2. Pipe Fittings:
  - a. All fittings shall be made in North America. Fittings shall be compact ductile iron fittings, 350 psi pressure rated, conforming to ANSI A21.53/AWWA C153. Joints and gaskets shall conform to ANSI 21.11/AWWA C111. Cement mortar lining shall be double cement-lined, conforming to ANSI A21.4/AWWA C104 as shown in the table below.

The Pipe shall be Class 52 with the following thickness:

| <u>Size</u> | <u>Thickness</u> |
|-------------|------------------|
| 6-inch      | 0.31             |
| 8-inch      | 0.33             |
| 10-inch     | 0.35             |
| 12-inch     | 0.37             |
| 16-inch     | 0.40             |

Mechanical Joints shall be furnished with ductile iron follower glands, or megalugs if specified. Fittings shall be double cement-lined and seal-coated inside and out in accordance with ANSI A21.4/AWWA C104. Tees for hydrant branches and for 6-inch stubs for future use shall have mechanical joints on the run with a plain end having an integral rotating gland on the branch. The gland will anchor mechanical joint pipe or valve ends to the plain end of the tee.

3. All ductile iron pipe and fittings shall be clean, sound

and without defects. The castings shall be smooth and free from pinholes, excess iron, etc. The coatings shall be continuous, smooth and neither brittle nor sticky.

4. Testing Certification for Ductile Iron Pipe

- a. The pipe manufacturer shall supply the Water Department with certificates of compliance with these specifications and certification that each piece of ductile iron pipe has been tested at the foundry with the Ball Impression Test, Ring Bending or other approved test for ductility.

C. VALVES

1. Resilient Seated Gate Valves

- a. Buried gate valves shall be nonrising stem, iron-body, bronze-mounted, resilient seated with mechanical joint ends. Gate valves shall conform to AWWA C500. Gate valves shall be designed for a minimum working pressure of 200 psi for sizes up to 12-inches in diameter. Higher working pressures up to 250 psi pressure rating may be necessary in certain high pressure areas of the system.
- b. Operating nuts shall be 2-inches square and shall open right. Stuffing box follower bolts shall be of plated steel and nuts shall be of bronze. O-ring stuffing boxes shall be used.
- c. The design and machining of valves shall be such as to permit replacing O-rings on the valve without undue leakage while wide open and in service.
- d. They shall be manufactured to meet or exceed the requirements of AWWA C-509 of latest revision. Valves shall have an unobstructed water way when fully opened equal in diameter to at least the nominal valve size. Valves shall have mechanical joint ends. Standard M.J. accessories are also to be provided.
- e. All internal surfaces shall be coated with epoxy to a minimum thickness of 4 mils. Said coating shall be non-toxic, impart no taste to water and shall conform to AWWA C-550 of latest revision.
- f. Valves shall be provided with two O-ring stem seals. Both O-rings shall be located above the thrust collar. The sealing mechanism shall provide a dual seal with zero leakage at the water working pressure when installed with the line flow in either direction, and shall consist of a cast iron gate having a vulcanized synthetic rubber coating with no rubber metal seams or edges in the water way when in the fully closed position.



- g. All valves shall be seat tested at the rated working pressure in accordance with Section 6 of AWWA C-509. Valve shall be rated at 200 psi working pressure and 400 psi test pressure.
  - h. Valves shall open right.
  - i. Submit shop drawings for approval.
2. Butterfly Valves
- a. All butterfly valves shall be of the rubber-seated tight-closing type and shall meet or exceed AWWA Specification C-504-70, with latest revisions. Valves shall be designed for underground service.
  - b. Valves shall have mechanical joint ends. Standard M. J. accessories are also to be provided.
  - c. Valve shall be equipped with a 2-inch AWWA operating nut and shall open right.
  - d. All valves shall be rated at 200 psi minimum working pressure and hydrostatically tested at 400 psi.
  - e. Valve body shall be of high strength ductile iron ASTM A126 Class B with 18-8 type 304 stainless steel body seat.
  - f. Rubber seat shall be a full circle 360N seat not penetrated by the valve shaft. Rubber seat shall be mechanically retained in the valve body and shall be capable of being replaced. Seats vulcanized or bonded to the body are not accepted.
  - g. All valves shall use full AWWA C-504 Class 150-B valve shaft diameter. Valve shaft shall be one piece for all valves sizes 4-inch through 12-inch and two piece for valves 14-inch and larger. Shafts shall be made of stainless steel or hi-tensile steel. One piece valve shafts shall extend full size through the entire valve and operator with no neckdown, keyways or holes. Two piece valve shafts shall be the stub type extending into the disc hubs for a distance of at least one and one-half (1-1/2) shaft diameters.
  - h. Valve shaft shall be sealed from waterway by means of stainless steel journals and "triple-seal" rubber packing designed for permanent duty in underground service. Valve disc shall be of the through shaft type made of high strength cast iron ASTM A-48 Class 40.
  - i. Valve operator shall be capable of withstanding an overload input torque of 450 ft.-lbs. at full open or closed position without damage to the valve or valve operator.

- j. Valve operator shall be of the worm and gear or traveling-nut type and shall use full AWWA C-504 Class 150-B torque rating throughout entire travel.
  - k. Valve operator and end cover shall be permanently sealed against ground water infiltration and valve shall be permanently lubricated at the factory.
  - l. Valves shall have thermosetting epoxy coating on the interior, exterior and the vane. The coating shall meet all requirements of AWWA C-550 of latest revision. All bodies and vanes shall be factory coated prior to assembly and testing. All ferrous surfaces of the valve body waterway and vane shall receive an ivory epoxy coating with a minimum dry film thickness of 8 mils. All exterior surfaces shall be coated with a gray epoxy with a minimum of 3 mils dry film thickness.
  - m. Valves shall open right.
  - n. Butterfly valves shall be M & H "450", Darling, Clow or approved equal by the Water Department.
  - o. Submit shop drawings for approval.
3. Valve Boxes
- a. Valve boxes shall be furnished for all valves and shall be made in North America. They shall be approved by the Water Department before use.
  - b. Valve boxes shall be standard cast-iron, asphalt coated, adjustable, sliding type, together with cast-iron covers with the word "water" plainly cast in relief on the top surface.
  - c. The bottom section shall have a minimum I.D. of 5-1/4-inches. The top section shall have a minimum diameter of 6-1/8-inches. There shall be a minimum 6-inch overlap between sections.
  - d. The bottom section shall be 48-inch in length for all butterfly valves and 36 inches in length for all gate valves. The top section shall be at least 26 inches in length and have a plain bottom. No three-piece combinations shall be acceptable.
  - e. Valve boxes shall be completely and thoroughly coated with bitumastic paint.

D. HYDRANTS

- 1. Hydrants shall conform to the requirements of AWWA C-502, and be designed for 200 psi working pressure tested to 300 psi hydrostatic pressure. In high pressure areas hydrants shall be designed for 200 psi working pressure tested to 400 psi hydrostatic pressure. Hydrants shall have 6-inch

mechanical joint shoe, 5-1/4-inch valve opening, and depth of bury as needed, open right with two 2-1/2-inch hose nozzles and one 4-1/2-inch pumper connection, National Standard Threads, operating nut and nozzle cap with non-kink safety chains.

2. Hydrants shall be the compression type, closing with the pressure. They shall be traffic model with safety flange and stem couplings. All hydrants shall be Mueller Super Centurion "200".
3. Hydrants shall be able to be rotated 360 degrees. They shall have a positive closing, self-cleaning drain valve and drainage area shall be completely bronze or brass lined.
4. Hydrants shall be painted yellow to match City's standard color. The bonnet shall be painted as directed by the Water Department. The paint shall be an epoxy paint as approved by the Water Department. Submit shop drawings for approval.

E. MISCELLANEOUS

1. Flexible or transition couplings to be used in connecting two plain ends of cast, ductile iron, or PVC pipe shall be ductile iron with bolts and nuts complying with AWWA C-111. Couplings shall be Dresser Style, Rockwell, Romac, or Smith-Blair (Omni).
2. Tapping Sleeves and Tapping Valves
  - a. Tapping sleeves shall be ductile iron, mechanical joint. Stainless steel is subject to approval by the Water Department. They shall contain a test plug for performing an air test. Submit shop drawings for approval.
  - b. Tapping valves shall conform in every way to the specification for gate valves cited in paragraph 2.03 above except that they shall have a flanged end on the inlet side and a mechanical joint end on the outlet side and shall be approved by the Water Department. Submit shop drawings for approval.
  - c. No full size taps (ex. 8-inch by 8-inch) shall be allowed.
3. Corporations, curb stops and copper tubing used for air vents or chlorine injection points shall be the same material as specified for water services and be 1-inch in size.
4. Where a flanged end is required on a pipe, Uniflange style flanges are not allowed

PART 3 EXECUTION

3.01 SERVICES GENERAL

- A. New water services will not be installed until the newly laid water main has been tested, chlorinated and accepted unless otherwise directed by the Water Department.
- B. All work on water services shall be coordinated with Water Department personnel.
- C. No dry taps shall be allowed.

3.02 SERVICES CONSTRUCTION

- A. Where new water mains are being installed and existing water services are to be transferred to the new main, the contractor shall discontinue the existing water services by shutting down the corporation stop at the old water main, unless specifically directed otherwise. The Contractor shall take special care to minimize the interruption with existing water service.
- B. The Contractor in making the water service transfers shall tap and install a new corporation stop in the new water main and connect new copper tubing to a new curb stop and box in a location acceptable to the Water Department. The contractor shall connect the new house service line to the old service line at least 2 feet beyond the new curb stop. The method of connection of the old house service to the new house service shall be approved by the Water Department.
- C. Wherever possible, new water services or renewed water services shall be installed with a minimum of ten (10) feet horizontal separation from a new or existing sewer service. Should lateral separation of ten (10) feet not be possible, then as much horizontal separation as possible must be maintained along with the maximum vertical separation possible. The water service must be laid on a higher bench of undisturbed soil or on a well compacted fine gravel material. When it is impossible to obtain horizontal and/or vertical separation as outlined above, then the water service shall be constructed of a water tight and structurally sound material as stipulated by the Water Department and laid in an approved manner and an approved support material. Consolidation and compaction around and over the newly installed water service shall be in accordance with Water Department directions. In this instance, both water service pipe and sewer service pipe shall be pressure tested by an approved method acceptable to the Water Department to ensure water tightness and structural integrity. In every instance the water service shall not be located under the sewer service. Every effort must be made to comply with the instructions outlined above.
- D. Where transfers are being made and the existing service is of lead or old unlined cast iron, the service shall be replaced to the curb stop and box unless otherwise directed. If required, the curb stop and box shall be replaced as specified above.

- E. Buried curb stop boxes shall be set plumb and centered with the box located directly over the stop. The box shall be set on a concrete block or flat stone. Earth fill shall be carefully tamped around the boxes to a distance of 4 feet on all sides of the box or to the undisturbed face of the trench, if less than 4 feet. The box shall be kept centered and remain plumb during and after all backfilling operations.
- F. All services shall be installed with a minimum cover of five feet 0 inches (5'-0") unless otherwise directed by the Water Department.
- G. Service connections shall be tested and disinfected in accordance with AWWA Standards.
- H. Copper tubing is required through the foundation wall from a point 10 feet outside of the foundation. A flared fitting is required to connect the copper tubing to a ball valve inside the foundation.

### 3.03 WATER MAINS, VALVES AND APPURTENANCES CONSTRUCTION

#### A. GENERAL

- 1. Pipe and accessories shall be handled and stored in such a manner as to insure that pipe is installed in sound, undamaged Condition. Particular care shall be taken not to injure the pipe coating or lining.
- 2. Ductile iron pipe and fittings and the cement linings are comparatively brittle. Every care shall be taken in handling and laying pipe and fittings to avoid damaging the pipe or lining, scratching or marring machined surfaces, and abrasion of the pipe coating or lining.
- 3. The Contractor shall neatly cut off all existing water mains at roadway intersections where existing valves and tees are scheduled to be replaced prior to the installation of the new water mains. All existing valves that are removed are to remain the property of the Water Department. The Contractor shall take care that all valves removed are not damaged during removal or damaged during temporary storage on the work site. All existing valves removed shall be returned to the Water Department yard the day of removal. They shall be carefully loaded and unloaded under Water Department supervision to prevent any valve damage. No dumping of valves from a loaded truck or piece of construction equipment shall be permitted.
- 4. If authorized, cutting of the pipe shall be done so that the cut is square and clean, without causing damage to the pipe lining. Unless otherwise authorized by the Water Department, all pipe cutting shall be done by means of an approved type of power cutter. The use of hammer and chisel, or any other method which results in rough edges, chips and damaged pipe, is prohibited. All cut edges shall

be field beveled by use of a power grinder, as required, prior to installation.

5. Each pipe section shall be placed into position in the trench in such manner and by such means required to cause no damage to the pipe, person or to property.
6. The Contractor shall furnish slings, straps and/or approved devices to provide satisfactory support of the pipe when it is lifted. Transportation from delivery areas to the trench shall be restricted to operations which can cause no damage to the pipe units and provide complete safety during transport.
7. Pipe shall not be dropped from trucks onto the ground or into the trench.
8. The Contractor shall have on the job site, with each laying crew, all the proper tools to handle and cut the pipe.
9. Damaged pipe coating and/or lining shall be restored before installation only as approved or directed by the Water Department.

#### B. PROTECTION OF PROPERTY BOUNDS

1. The Contractor shall carefully preserve all public benchmarks, reference points and property bounds encountered. In the case of willful or careless destruction by his own workers, he will be charged with the resulting expense for their replacement and shall be responsible for any mistakes or delay that may be caused by their unnecessary loss or disturbance.
2. Insofar as possible, the Contractor shall confine his construction activities to those areas defined by the approved work. All land resources within the project boundaries and outside the limits of permanent work to be performed shall be preserved in their present condition or be restored to a condition after completion of construction at least equal to that which existed prior to the beginning of the work.
3. Except in areas designated to be cleared, the Contractor shall not deface, injure, or destroy trees or shrubs nor remove or cut them without special authority. No ropes, cables or guys shall be fastened to or attached to any existing nearby trees for anchorage unless specifically authorized by proper authority. The Contractor shall in any event be responsible for any damage resulting from such use and for all costs associated with proper repair or restoration.

#### C. PREPARATION OF BED

1. As soon as excavation has been completed to required depth, place and compact bedding material to the elevation

necessary to bring the pipe to proper grade.

2. The compacted bed shall be rounded so that at least the bottom quadrant of the pipe shall rest firmly for the full length of the barrel. Suitable holes for bells or couplings shall be dug around the pipe joints to provide ample space for making tight joints.
3. The trench bottom shall be straight, free of bumps or hollows and at the proper depth. Any irregularities in the trench bottom shall be leveled off or filled in with a selected gravel or sand thoroughly tamped.
4. If determined by the Water Department, the trench bottom shall be prepared by digging at least 6-inches deeper than pipe grade and backfilling to proper grade with a selected gravel or sand backfill properly tamped.
5. All unsuitable material shall be removed from the bottom of the trench excavation as directed by the Water Department to the depths ordered. The trench shall be backfilled with an approved gravel backfill material, placed in 6-inch layers, to within 6-inches of proper pipe grade. Each gravel lift shall be thoroughly tamped. A 6-inch layer of selected gravel or sand shall be placed and tamped for proper pipe support.

#### D. LAYING PIPE

1. Laying of pipe and fittings shall be in accordance with the requirements of AWWA Standard Specifications for Installation of Ductile Iron Water Mains, AWWA C600, except as otherwise provided herein.
2. In all cases the trench shall be wide enough to provide suitable space for assembling the materials and with the depth and cover set forth in the following table:
  - a. Where pipes pass under brooks, the top of the pipe is to be not less than 3 feet below the earth bed of the brook unless directed. Where existing pipes, conduits, drains, culverts, cables, wires, etc. are at such a grade as to interfere with the laying of the new water mains, at all specified depths, the new mains shall be installed by the Contractor at greater depth in order to clear the obstructions by at least six (6) inches.
3. Each pipe length shall be inspected for cracks, defects in coating or lining, and any other evidences of unsuitability. Contractor shall excavate a minimum amount of trench and shall backfill trench to within 2 lengths of pipe laying. All trenches shall be backfilled at the end of the work day, unless otherwise approved by the Water Department.
4. Pipe shall be laid in a dry trench and at no time shall water be permitted to flow into the pipe.

5. The pipe shall then be laid on the trench bedding, and the pipe pushed home. Jointing shall be in accordance with the manufacturer's instructions and appropriate ASTM Standards, and the Contractor shall have on hand for each pipe laying crew, the necessary tools, gauges, pipe cutters, tamping bars, etc. necessary to install the pipe in a workman like manner.
6. Blocking under the pipe will not be permitted except where a concrete cradle is proposed, in which case precast concrete blocks shall be used.
7. If inspection of the pipe indicates that the pipe has been properly installed as determined by the Water Department personnel, the Contractor may then refill or backfill the remainder of the trench in accordance with the specifications.
8. At any time that work is not in progress, the end of the pipe shall have a temporary plug to prevent the entry of animals, earth, water, etc.
9. Acceptable alignment shall be preserved in laying. The deflection at joints shall not exceed 3 degrees, or 12 inches for an 18-foot length of pipe. Fittings, shall be provided, if required, in crossing utilities which maybe encountered upon opening the trench. Solid sleeves shall be used only where approved by the Water Department.
10. Concrete thrust blocks shall be installed at all fittings and other locations as directed by the Water Department. Minimum bearing area shall be shown on the details. Joints must be protected by felt roofing paper or heavy plastic prior to placing concrete. Concrete shall be placed against undisturbed material, and shall not cover joints, bolts or nuts, or interfere with the removal of any joint. Wooden side forms shall be provided for thrust blocks.
11. Push-on joints shall be made in strict accordance with the manufacturer's instructions. Pipe shall be laid with bell ends on the upstream side. A rubber gasket shall be inserted in the groove of the bell end of the pipe and joint surfaces cleaned and lubricated. The plain end of the pipe to be entered shall then be inserted in alignment with the bell of the pipe to which it is to be jointed and pushed home with a jack or by other means. After jointing the pipe, a metal feeler shall be used to make certain that the rubber gasket is located correctly. Two brass wedges shall be installed at the top of each pipe joint spaced.
12. Mechanical joints at valves, fittings and where designated shall be in accordance with the "Notes on Method of Installation" under ANSI Specification A21.11 and the instruction of the manufacturer. To assemble the joints in the field, the Contractor shall thoroughly clean the joint surfaces and rubber gasket with soapy water before



tightening the bolts. Bolts shall be tightened to the specified torques. Under no conditions shall extension wrenches or extension pipes over wrench handles or ordinary ratchet wrenches be used to secure greater leverage through the specified torque. A megalug gland shall be used in place of the usual follower gland in a mechanical joint application where specific circumstances exist if directed by the Water Department.

13. When cutting a new tee into an existing water main or when installing a sleeve type coupling, accurate measurements must be taken to insure close tolerances are maintained between the existing water main and any new pipe nipples to be installed. No space greater than 1/2-inch shall be allowed without specific Water Department approval. The area of the existing water main to be cut out shall be exposed, the pipe area to be cut out thoroughly cleaned and an existing pipe outside diameter measurement taken prior to any work commencing to insure any sleeves or couplings to be used meet the required O.D. range.

#### E. PROTECTION OF EXISTING STRUCTURES

1. All existing pipes, poles, wires, fences, curbs, property line markers and other structures, which the Water Department decides must be preserved in place without being temporarily or permanently relocated, shall be carefully supported and protected from damage by the Contractor. Should such items be damaged, they shall be restored by the Contractor, without compensation, to at least the original condition in which they were found immediately before the work was begun.
2. When pipe installation occurs in close proximity to electric or telephone company poles, the Contractor shall contact the appropriate electric and telephone companies to arrange for proper pole support during water main installation, until trench backfill and compaction has been accomplished in the vicinity of each affected pole.
3. When fences interfere with the Contractor's operations, he shall remove and (unless otherwise specified) later restore them to their original condition.
4. The Contractor shall enclose the trunks of trees adjacent to his work and not to be cut, with substantial wooden boxes of such height as may be necessary to protect them from injury from piled material, from equipment, from his operations, or otherwise due to his work. Excavating machinery and cranes shall be of suitable type and be operated with care to prevent injury to trees not to be cut and particularly to overhanging branches and limbs.
5. Branches, limbs, and roots shall not be cut except by permission of the Water Department. All cutting shall be smoothly and neatly done without splitting or crushing. In case of cutting or unavoidable injury to branches, limbs,

and trunks of trees, the cut or injured portions shall be neatly trimmed and covered with an application of grafting wax or tree healing paint as directed.

6. Cultivated hedges, shrubs, and plants on public or private property which might be injured by the Contractor's operations shall be protected by suitable means or shall be dug up, balled and temporarily replanted and maintained. After the construction operations have been substantially complete, they shall be replanted in their original positions and cared for until growth is re-established. If cultivated hedges, shrubs, and plants are injured to such a degree as to affect their growth or diminish their beauty or usefulness, they shall be replaced by items of kind and quality at least equal to the kind of quality existing at the start of the work.
7. On paved surfaces the Contractor shall not use or operate tractors, bulldozers, or other power-operated equipment the treads or wheels of which are so shaped as to cut or otherwise injure such surfaces.
8. All surfaces which have been injured by the Contractor's operations shall be restored to a condition at least equal to that in which they were found immediately before work was begun. Suitable materials and methods shall be used for such restoration.
9. The restoration of existing property or structures shall be done as promptly as practicable and shall not be left until the end of the construction period.

#### F. EXCAVATION

1. Pipe trenches shall be made as narrow as practicable and shall not be widened by scraping or loosening materials from the sides. Every effort shall be made to keep the sides of the trenches firm and undisturbed until backfilling has been completed and consolidated.
2. Cut pavements sufficiently wide and remove to enable installation of pipe and allow inspection. Pavement cutting shall be done by saw cut pavement breaker or wheel cutter of sufficient size to properly penetrate the total thickness of the pavement. Cutting shall be made in a neat, true, straight line established by chalk line or painting of existing pavement. All cutting methods will be approved by the Water Department before any pavement cutting begins. Proper disposal of excavated pavement is the responsibility of the Contractor.
3. Remove from within trench limits, muck, peat or other unsuitable material below grade which in the opinion of the Water Department is incapable of supporting the pipe. The trench shall then be backfilled with an approved backfill material, placed in 6-inch layers. Each lift shall be thoroughly compacted.

4. Correct unauthorized excavation at no cost to the Water Department. Backfill with material approved by Water Department.
5. Stockpile excavated material in area designated on site and remove unsuitable subsoil or excess subsoil not being reused, from site.
6. Hand trim excavation and leave free of loose matter.

G. BACKFILLING

1. When necessary, compact subgrade surfaces to 95% of maximum density.
2. Backfill beneath pipe areas from which unsuitable bearing material has been removed with bedding material.
3. Support pipe and conduit as specified by the pipe manufacturer during placement and compaction of bedding fill.
4. Bed for ductile iron pipe shall be as specified herein.
5. Cover ductile iron pipe to 12 inches over crown with common fill in 6-inch layers properly tamped by hand using standard tamping bars.
6. Machine backfill to within 18-inches of trench resurfacing in 18-inch minimum lifts compacting to 95 percent maximum density using mechanical compaction methods. Water jetting and/or puddling will not be allowed. Backfill material shall contain no stones larger than 6-inches in diameter.
7. Frozen material shall not be placed in the backfill nor shall backfill be placed on frozen material. Previously frozen material shall be removed or otherwise treated before new backfill is placed.
8. Where the trench occurs adjacent to paved streets in shoulders or sidewalks, the Contractor shall compact as specified elsewhere in these specifications the backfill and shall maintain the surface as the work progresses. If settlement takes place he shall immediately deposit additional fill to restore the level of the ground.
9. Adjacent to streets and highways the top 18-inch layer of trench backfill shall consist of compacted gravel base course as specified. If in the opinion of the Water Department, the existing top 18-inch layer is unsuitable for use as subgrade or shoulder material, he may order the Contractor to remove this layer and to backfill with gravel borrow compacted to at least 95 percent of maximum dry density as determined by ASTM D1557, Method C.
10. All common and backfill materials to be compacted to 95% of

maximum density as computed using ASTM D1557.

H. SURPLUS EXCAVATED MATERIALS

1. No excavated material shall be removed from the site of the work or disposed of by the Contractor except as directed or approved by the Water Department.
2. Surplus excavated materials shall, with the approval of the Water Department, be used to backfill normal excavations in rock or to replace other materials unacceptable for use as backfill; shall be neatly deposited and graded so as to make or widen fills, flatten side slopes, or fill depressions; or shall be neatly deposited for other purposes indicated by the Water Department, within its jurisdiction limits; all as directed or approved and without additional compensation.
3. Surplus excavated material not needed as specified above shall be hauled away and properly disposed of by the Contractor, at his expense, at appropriate locations, and in accordance with arrangements made by him.

I. INSTALLATION OF VALVES AND FITTINGS

1. Valves and boxes shall be set with the stem vertical and box vertically centered over operating nut. Valves shall be set on a firm foundation and supported by tamping selected excavated material under and at the sides of the valve. The gate box shall be supported during backfilling and maintained in vertical alignment with the top flush with finish grade.
2. Valves shall be anchored to all tees, fittings or piping where possible with 3/4" threaded rods. If rods cannot be used, megalug glands will be the method of restraint subject to approval by the Water Department.
3. Install couplings and fittings in accordance with manufacturer's instructions.
4. Tapping sleeves and valves shall be installed in accordance with manufacturer's instruction and AWWA C500. They shall be set vertically and squarely centered on the main to be tapped. Adequate support shall be provided under the sleeve and valve during the tapping operation. Sleeves shall be no closer than three feet from water main joints. Installation shall be made under pressure and the flow of water through the existing main shall be maintained at all times. Thrust blocks shall be provided behind all tapping sleeves. Proper tamping of supporting earth around and under the valve and sleeve is mandatory. After completing the tap, the valve shall be flushed to ensure that the valve seat is clean. Only workmen experienced in the installation of tapping sleeves and valves shall be allowed to perform the work. Perform air test on installed tapping sleeve before tap is made.

J. INSTALLATION OF HYDRANTS

1. Hydrants shall be set at the location shown and bedded on a firm foundation. A drainage pit 3 feet in diameter and 2 feet deep below and to the rear of the hydrant shall be filled with crushed stone and satisfactorily compacted. During backfilling, additional peastone shall be brought up around and 6 inches over the drain port. Where directed by the Water Department, the Contractor shall install plugs in the hydrant drain ports. No hydrant shall be backfilled until Contractor is directed to do so by the Water Department. Each hydrant shall be set in true vertical alignment and properly braced. Concrete thrust blocks shall be placed between the back of the hydrant inlet and undisturbed soil at the end of the trench. All hydrants shall be installed with 3/4" threaded rods or megalugs on all mechanical joints. Roofing felt shall be placed around hydrant elbow before placing concrete. Care shall be taken to insure that concrete does not plug the drain ports.
2. Removal of Existing Hydrants
  - a. All existing hydrants removed during the installation of the water main shall remain the property of the Water Department and shall be returned to the Water Department yard as directed under the conditions cited in paragraph 3.03.A.3.

K. INSTALLATION OF CORPORATION AND SERVICES

1. The tapping machine shall be rigidly fastened to the pipe half way between the horizontal and vertical position. The length of travel of the tap should be so established that when the stop is inserted and tightened with a 14-inch wrench, not more than one to three threadswill be exposed on the outside. When a wet tapping machine is used, the corporation stop shall be inserted with the machine while it is still in place. Stops shall be tightened only sufficiently to give water tightness, and care must be constantly exercised not to over tighten them. Dry taps will not be allowed.
2. Care shall be exercised in the placing and laying of tubing to be sure that the pipe does not have kinks or sharp stones or ledge which would cause damage to the pipe. Place at least 6 inches of sand adjacent to, above and below the tubing. No stones shall be placed in the backfill near or on the tubing until the depth of backfill above the tubing is in excess of one foot.
3. Make connections of new services with existing services unless otherwise directed by the Water Department. Use bushings and/or couplings as required to connect new tubing with existing services.

L. INSTALLATION OF MANUAL AIR RELEASE/CHLORINATION INJECTION POINTS

1. Install each gate box vertically, centered over the operating key, with the elevation of the top adjusted to conform to the finished surface at the completion of the Contract. Adequately support the box during backfilling to maintain vertical alignment.
2. Installation of chlorination taps shall be in accordance with paragraph 3.11 Installation of Corporations and Services.
3. The exact location of the manual air releases will be determined in the field by the Water Department.

M. TESTING

1. The Contractor shall furnish all labor, pumps, taps, chemicals, and other necessary equipment (except test gauges) to conduct hydrostatic pressure tests and measured leakage test; and to sterilize thoroughly the mains laid under this contract in accordance with Section 4 AWWA C600-82 - Installation of Ductile Iron Water Mains. The tests and sterilization shall be conducted at a time specified by and under the supervision and direction of the Water Department who shall judge the success or failure of the work to meet the required standards. In the event that the work fails to meet the required standards as stated herein, the Contractor shall perform such excavation, repair, relaying of pipe, rechlorinating, and all other work necessary to correct the work; and shall repeat the tests or chlorination as often as may be necessary and until such time as the required standards are met. The Water Department will certify as to the success or failure of the tests and the sterilization, and such certification by the Water Department as to the success of such tests and sterilization shall be one of the requisites to final acceptance of the work. The Water Department shall furnish the water for the initial testing. In the event of repeated failures or repair work and excessive water is used, it shall be billed to the contractor at the prevailing water rate should the Water Department so decide.

N. PRESSURE TESTS

1. Before applying the specified test pressure, all air shall be expelled from the pipe. If suitable means of expelling air are not available at high places, the Contractor, at his own expense, shall make all the necessary taps as directed by the Water Department. After the tests have been completed, the corporation stops shall be left in place or removed and plugs inserted, as directed by the Water Department.
2. The newly laid pipe shall be tested in valved or plugged sections as determined in the field. Water shall be slowly introduced into the section being tested by means of an approved power-driven high pressure test pump.

3. The newly laid pipeline shall be tested to a pressure equal to 150% of the maximum static pressure for the section being tested, measured at the lowest point of the section being tested corrected to the elevation of the test gauge with the minimum test pressure of 200 psig. If the static pressure of any newly laid section of pipeline being tested is less than 100 psig measured at the lowest point of the pipeline section, then the minimum test pressure shall be 200 psig.
4. Test pressure shall:
  - a. Not be less than 1.5 times the working pressure at the highest point along the test section.
  - b. Not exceed the pipe or thrust restraint design pressure.
  - c. Be of at least two hours duration.
  - d. Not vary by more than  $\pm 5$  psi for two (2) hours or the duration of the test.
  - e. Not exceed twice the rated pressure of the valves or hydrants when the test section includes closed gate valves or hydrants.
  - f. Not exceed the rated pressure of the valves when the test section includes closed resilient-seated gate valves or butterfly valves.
5. The pressure shall be raised to the test pressure required for each section being tested or 200 psig minimum as determined by the Water Department. When the test pressure is reached, the time shall be recorded and the test shall begin. The duration of each pressure test shall be a minimum of two hours. During the test, pressure shall be maintained in the section of the pipeline being tested by means of a recirculating by-pass type test pump. Water shall be added in measured amounts from a container of known volume if required to maintain pressure. The addition of excessive amounts of water shall constitute immediate test failure. The Contractor will provide workable test gauges which shall be field checked by the Water Department.
6. During the test, the line will be examined by the Water Department for visible leaks and breaks. Any defects in the works shall be repaired, and any defective materials shall be removed and replaced by the Contractor as and where directed by the Water Department.

O. LEAKAGE TEST

1. Method of Testing. The leakage test shall be conducted concurrently with the pressure test. Leakage shall be

defined as the quantity of water that must be supplied into the newly laid pipe, or any valved section thereof, to maintain pressure within 5 psi of the specified test pressure after the air in the pipeline has been expelled and the pipe has been filled with water. Leakage shall not be measured by a drop in pressure in a test section over a period of time.

2. No pipe installation will be accepted if the leakage is greater than that determined by the following formula:

$$L = \frac{SD\sqrt{P}}{133,200}$$

in which L is the allowable leakage, in gallons per hour; S is the length of pipe tested, in feet; D is the nominal diameter of the pipe, in inches; and P is the average test pressure during the leakage test, in pounds per square inch gauge.

3. Allowable leakage at various pressures is shown in the following table:

Allowable Leakage per 1000 ft (305 m) of Pipeline\*--gph\*\*

| Avg. Test Pressure<br>psi (Bar) | Nominal Pipe Diameter-in. |      |      |      |      |      |      |      |      |      |      |      |      |
|---------------------------------|---------------------------|------|------|------|------|------|------|------|------|------|------|------|------|
|                                 | 3                         | 4    | 6    | 8    | 10   | 12   | 14   | 16   | 18   | 20   | 24   | 30   | 36   |
| 450 (31)                        | 0.48                      | 0.64 | 0.95 | 1.27 | 1.59 | 1.91 | 2.23 | 2.55 | 2.87 | 3.18 | 3.82 | 4.78 | 5.73 |
| 400 (28)                        | 0.45                      | 0.60 | 0.90 | 1.20 | 1.50 | 1.80 | 2.10 | 2.40 | 2.70 | 3.00 | 3.60 | 4.50 | 5.41 |
| 350 (24)                        | 0.42                      | 0.56 | 0.84 | 1.12 | 1.40 | 1.69 | 1.97 | 2.25 | 2.53 | 2.81 | 3.37 | 4.21 | 5.06 |
| 300 (21)                        | 0.39                      | 0.52 | 0.78 | 1.04 | 1.30 | 1.56 | 1.82 | 2.08 | 2.34 | 2.60 | 3.12 | 3.90 | 4.68 |
| 275 (19)                        | 0.37                      | 0.50 | 0.75 | 1.00 | 1.24 | 1.49 | 1.74 | 1.99 | 2.24 | 2.49 | 2.99 | 3.73 | 4.48 |
| 250 (17)                        | 0.36                      | 0.47 | 0.71 | 0.95 | 1.19 | 1.42 | 1.66 | 1.90 | 2.14 | 2.37 | 2.85 | 3.56 | 4.27 |
| 225 (16)                        | 0.34                      | 0.45 | 0.68 | 0.90 | 1.13 | 1.35 | 1.58 | 1.80 | 2.03 | 2.25 | 2.70 | 3.38 | 4.05 |
| 200 (14)                        | 0.32                      | 0.43 | 0.64 | 0.85 | 1.06 | 1.28 | 1.48 | 1.70 | 1.91 | 2.12 | 2.55 | 3.19 | 3.82 |
| 175 (12)                        | 0.30                      | 0.40 | 0.59 | 0.80 | 0.99 | 1.19 | 1.39 | 1.59 | 1.79 | 1.98 | 2.38 | 2.98 | 3.58 |
| 150 (10)                        | 0.28                      | 0.37 | 0.55 | 0.74 | 0.92 | 1.10 | 1.29 | 1.47 | 1.66 | 1.84 | 2.21 | 2.76 | 3.31 |
| 125 (9)                         | 0.25                      | 0.34 | 0.50 | 0.67 | 0.84 | 1.01 | 1.18 | 1.34 | 1.51 | 1.68 | 2.01 | 2.52 | 3.02 |
| 100 (7)                         | 0.23                      | 0.30 | 0.45 | 0.60 | 0.75 | 0.90 | 1.05 | 1.20 | 1.35 | 1.50 | 1.80 | 2.25 | 2.70 |

\* If the pipeline under test contains sections of various diameters, the allowable leakage will be the sum of the computed leakage for each size.

\*\* To obtain leakage in litres/hour, multiply the values in the table by 3.785.



4. When testing against closed metal-seated valves, an additional leakage per closed valve of 0.0078 gal/h/in. of nominal valve size shall be allowed.
5. When hydrants are in the test section, the test shall be made against the closed hydrant.
6. Acceptance shall be determined on the basis of allowable leakage. If any test of pipe laid discloses leakage greater than that specified, the Contractor shall, at his own expense, locate and make repairs as necessary until the leakage is within the specified allowance.
7. All visible leaks are to be repaired regardless of the amount of leakage. At the end of the test period if the amount of water added to the main from the calibrated vessel is less than the allowable leakage, and if the line shows no visible leaks or other failures, that portion of the main tested will be approved.

P. TESTING OF VALVES AND HYDRANTS

1. The pump to be used for testing and chlorination shall be of sufficient size to be able to test to the pressure required and shall contain a by-pass arrangement. Test pump arrangement to be used shall be approved by the Water Department prior to any pressure testing.
2. All valves and hydrants shall be pressure tested during the main pipeline test. Hydrant gate valves shall remain open during the main pressure test. After the pipeline has been pressure tested and accepted the hydrant gate valve shall be closed and the hydrant valve cracked open to release some pressure on the hydrant side of the gate valve. An acceptable test for each hydrant gate valve shall be no loss of pressure in the main line test pressure after each hydrant gate valve is closed.
3. All main line butterfly or gate valves and control valves on any intersecting side streets shall also be tested by the same procedures outlined above as far as practical. The Water Department shall decide if it is impractical to test any one particular valve location. No pressure test shall be considered acceptable until all possible control valves have been tested to insure proper closing and water tightness.
4. The Contractor shall make any taps and furnish all necessary caps, plus, etc., as required in conjunction with testing at his own expense. He shall also furnish a test pump, gauges and any other equipment required in conjunction with carrying on the hydrostatic tests. He shall at all times protect the new water mains and the existing water mains against the entrance of polluting material.

Q. CHLORINATION

1. After satisfactory pressure and leakage tests have been made, before placing the newly-laid mains in service, the Contractor shall disinfect the water main by chlorination.
2. Prior to chlorination, the mains shall be flushed to remove dirt and other foreign substances.
3. The mains shall be disinfected by the Contractor under the supervision of the Water Department. The Contractor shall use a manually controlled, vacuum type solution feed chlorinator using a mixture of water and an approved chlorine-bearing compound of known chlorine content, such as calcium hypochlorite. The chlorine shall be introduced into the main through a 1-inch corporation stop installed approximately one foot up-stream from the valve at the beginning of the job and shall be tested for residual chlorine at a 1-inch corporation stop installed approximately one foot from the downstream valve at the end of the project.
4. Water from an approved source shall be introduced slowly into the main during the application of chlorine. The rate of chlorine mixture flow shall be in such proportion to the rate of water entering the pipe that the chlorine dose entering the mains shall be at least 50 parts per million, but no more than 100 parts per million. When the pipe line has been completely filled with treated water, the main shall be sealed off. Treated water shall be retained in the main for a period of twenty-four (24) hours. At the end of the retention period, the chlorine residual at the extremities of the pipe and at other representative points shall be at least 5 parts per million.
5. Should the first treatment fail to meet the above requirements, the procedure shall be repeated until tests show that, in the opinion of the Water Department, effective disinfection has been accomplished. Excessive additional water used for re-sterilization may be charged to the contractor at the existing water rate if the Water Department so decides.
6. Following acceptance of the disinfection process, the chlorinated water shall be flushed from the newly-laid main until such time as the replacement water throughout its entire length shall be equal in quality to that elsewhere in the system.
7. A representative water sample shall be collected of the potable water now present in the new pipeline by the Contractor under the supervision of the Water Department. This sample shall be taken to a Massachusetts DEP certified laboratory for a bacteria analysis. The cost associated with the collection and analysis of the sample shall be paid for by the Contractor.

8. Special disinfection procedures, such as soaking or swabbing, approved by the Water Department, shall be used in connections to existing mains and where the method outlined above is not practicable.

R. CONNECTION TO EXISTING SYSTEM

1. The Contractor shall furnish all necessary labor, tools, joint materials, equipment, etc. to connect new water pipes to existing water pipes with the required proper fittings. Flexible transition couplings used to connect new water pipes to existing water pipes shall be approved by the Water Department.
2. All connections shall be made at such time and in such a manner as to cause as little interruption in water service as possible.
3. Coordination of all such work shall be made with the Water Department who shall be present when the work is done and shall operate all valves. The Contractor shall notify the Water Department 24 hours in advance of when he plans to connect into the existing water mains.
4. All materials, equipment and labor necessary for the connection of the new water mains to the existing water mains shall be accomplished as directed by the Water Department and shall be paid for by the Contractor.

S. SEWER SERVICES AND DRAIN LINES

1. The Contractor shall exercise caution to properly protect the existing sewer services and drain pipes from construction damage. Many of these services are extremely old clay pipes and their specific locations were never properly recorded. It shall be the Contractor's responsibility to demonstrate that all existing active sewer services and drains are functioning properly after the installation of the proposed water main or proposed water services to the satisfaction of the Owner. All inactive sewer services encountered during the proposed work shall be cut and plugged with concrete at the direction of the City Engineer.
2. Damage to existing drains and sewer services shall be repaired and/or replaced with materials of the same size as the existing service. Existing slopes and inverts shall be maintained. Pipe joints shall be made using suitable flexible couplings, approved by the City Engineer. Fernco couplings are an acceptable coupling for sewer service repair. The Contractor shall use same. Concrete mortar joints will not be accepted.
3. If damage occurs to existing house or business sewer services or storm drains and acceptable repairs are accomplished as outlined above, the contractor shall be

required to adequately demonstrate to the City Engineer that the repaired service is functioning normally before any backfill material shall be allowed to be placed.

END OF SECTION

DOCUMENT A00808

# **PROJECT UTILITY COORDINATION FORM**

THIS PAGE INTENTIONALLY LEFT BLANK



# Project Utilities Coordination (PUC) Form

CONTACTS AND GENERAL UTILITY INFORMATION

Revision  
Date: 10/14/2022

5/3/2023  
PRINTED

|   |                                  |  |   |
|---|----------------------------------|--|---|
| <b>City/Town:</b><br>Fitchburg                                  | <b>Project File #:</b><br>607680 | <b>PUC Completed by:</b><br>C. Grygorciewicz | <b>Utility Pole Set:</b><br>Unitil Electric |
| <b>Route/Street:</b><br>River Street (Rt. 31) over Nashua River | <b>Resident Engineer:</b><br>TBD | <b>Mass DOT PM:</b><br>Harry Adolphe         | <b>Scheduled Ad Date:</b><br>7/15/2023      |
| <b>Consultant:</b><br>STV Inc.                                  |                                  |  | <b>Total Poles Relocated:</b><br>0          |

| Utility Company      | Contact             | Office #     | Cell # | Email                               | Scope, Budget, Duration Submitted |     | Reimbursement |             | Notes |    | Potential for District Initiated Early Relocation * |    | Utilities On Bridge/Structure |    | Utilities Underground (UG) /Aerial (OH) |  |
|----------------------|---------------------|--------------|--------|-------------------------------------|-----------------------------------|-----|---------------|-------------|-------|----|---|----|-------------------------------|----|---|--|
|                      |                     |              |        |                                     | Yes                               | No  | Agreement     | Non-Reimb'l | YES   | NO | YES   | NO | UG                            | OH |   |  |
| Unitil Electric      | Mark Frappier       | 978-353-3217 |        | frappier@unitil.com                 | X                                 |     | X             |             |       |    | X   |    |                               | X  |   |  |
| Verizon              | Paul Styspeck       | 413-787-1845 |        | paul.m.styspeck@verizon.com         | X                                 |     | X             |             |       |    | X   |    |                               | X  |   |  |
| Unitil Gas           | Daniel Golden       | 978-829-1905 |        | golden@unitil.com                   | X                                 |     | X             |             |       |    | X   |    |                               | X  |   |  |
| Fitchburg DPW        | Nicholas Erickson   | 978-829-1905 |        | Nerickson@fitchburgma.gov           |                                   | n/a | n/a           |             |       |    |   |    |                               |    |   |  |
| American U-Tel       | Mike Weiss          | 440-946-6027 |        | mike@americanutel.com               |                                   | n/a | n/a           |             |       |    |   |    |                               |    |   |  |
| Crown Castle         | Christopher Stevens |              |        | christopher.stevens@crowncastle.com |                                   | n/a | n/a           |             |       |    |   |    |                               |    |   |  |
| Verizon Business/MCI | Stephen Parrretti   |              |        | stephen.parrretti@verizon.com       |                                   | n/a | n/a           |             |       |    |   |    |                               |    |   |  |

### Utility Relocation Notes for MassDOT Contractor

Unless otherwise noted by Contract, the MassDOT Contractor is to provide the District Construction Office with 7 Calendar Days advance notification in order to validate the current progress and provide the required 30 Days advance notice-to-proceed for the first Utility - and each subsequent Utility. These advance notifications are to be identified in the Contractor's Schedules (Pre-Con preparation, Baseline, Subnets, and Updated/Monthly Schedules) as specified in Subsection 8.02. Note: The durations included below do not include these lead-times. See Additional 'Important Basis notes for Contractor' - on last PUC Form page.

### Additional notes:

\*MassDOT contractor to provide utility bay cross frames, 10" ductile water main, restrained pipe fittings, polyurethane insulation, aluminum jacketing, u-bolts, sleeve through abutments, end seals, casing and gate valves, connection shut-off and tying to existing water line.  
 †City of Fitchburg to test and run service.

### Suggested Sequence of Relocation (Based on Consultant proposed construction staging)

The sequence as detailed on the following pages is based on the consultants proposed staging plan. This information was compiled through meetings that included all of the utilities listed below along with the designer and the City of Fitchburg. The information provided is the best available information prior to project advertisement.

PUC FORM - CONTINUED

|  |     |    |
|--|-----|----|
| Is 'enabling' (prep) work, by the Contractor, necessary prior to the start of the first series of utility relocations: | Yes | No |
|  | X   |    |
| Has any of the Utility work been identified to work concurrently   | Yes | No |
|  |     | X  |

5/3/2023  
PRINTED



| RESPONSIBLE PARTY | C = Contractor<br>U = Utility Co. | DESCRIPTION - Utility Relocation Phases, Tasks and Activities   | Estimated Duration (Work Days) by Utilities (Lead time not included) | Concurrent / Exclusive Utility Work                 |  |   |                     | Access Restraint & Limitations of Operations Notes |
|-------------------|-----------------------------------|---|--|---|--|---|---------------------|--|
|                   |                                   |   |  | Utility working with no other utilities in vicinity | Utility working with other utilities on site | No Contractor physical construction operations on-site (while Utility is working) | Contractor Off-Site |  |
| Phase 1A          | C                                 | Enabling' work by the Contractor - Install TTCP for Phase 1 as detailed on the plans. Complete design and installation of Temporary Utility Bridge for the temp. relocation of existing electric, gas and sewer lines. Coordinate with Unutil Electric & Unutil Gas for required utility supports on temp. bridge. For gas - MADOT Contractor to provide brackets and rollers for gas main, Unutil Gas to provide pipe. Contractor to install brackets(per Unutil specifications) for gas main onto temp. bridge, Unutil Gas to install rollers and pipe. For electric - Contractor to supply and install supports and conduit for electric on temp. bridge and approaches to Unutil Electric manholes. Unutil Electric to extend conduit to manhole and break into Unutil Electric manholes. Unutil Electric will pull cables and make final connections inside manhole. Installation of temporary sewer bypass to be coordinated with City of Fitchburg. Locate existing sewer line at abutments using test pits (one at each approach) prior to pile driving operations. |  |   |  |   |                     |  |
| Task: 1           | U                                 | <b>UTILITY OPERATIONS - Underground</b><br><b>Unutil Electric</b><br>U Work with MADOT contractor - install conduits to manholes<br>U Install temporary circuits in utility bridge<br>U Splice cables<br>U Remove existing circuits<br>U Circuit Switching  | 1<br>2<br>3<br>1<br>1  |   |  |   |                     |  |
| Task: 2           | U                                 | <b>Unutil Gas</b><br>U Excavate and prep for tie-in North side of bridge<br>U Excavate and prep for tie-in South side of bridge<br>U Prep and install roller and guides to receive 8-inch steel pipe<br>U Weld together 8-inch steel pipe and set on temp bridge<br>U Non-destructive testing of weld<br>U Tie-in South side<br>U Tie-in North side<br>U Backfill and complete  | 1<br>1<br>2<br>8<br>2<br>2<br>2<br>1                                 |   |  |   |                     |  |
|                   |                                   | <b>Sub-Total</b>  | <b>19</b>  |   |  |   |                     |  |
| Phase 1B          | C                                 | Enabling' work by the Contractor - Construct Northern side of bridge including installation of water main. Coordinate relocation of Unutil Gas and Unutil Electric facilities into the Northern side of the bridge. For gas main - Unutil will provide the pipe, MADOT Contractor to provide the brackets and rollers. MADOT Contractor to install brackets, Unutil Gas to install rollers and pipe. MADOT Contractor to provide and install sleeve for gas line in abutment - Unutil gas will provide casing spacers and end seals. For electric - Contractor to supply and install supports and place conduit per plan for electric on bridge and both roadway approaches. Unutil Electric to make final connection to electric conduit/manholes and pull new cables.   |  |   |  |   |                     |  |
| Task: 1           | U                                 | <b>UTILITY OPERATIONS - Underground</b><br><b>Unutil Gas</b><br>U Prepare new bridge corridor for 8-inch steel main<br>U Install rollers and guides on new bridge<br>U Weld together 8-inch steel pipe for new bridge and install on bridge<br>U Non-destructive testing of weld<br>U Tie-in South side<br>U Tie-in North side<br>U Install end seals and covers at abutments<br>U Backfill and complete  | 1<br>2<br>8<br>2<br>2<br>1<br>1                                      |   |  |   |                     |  |
| Task: 2           | U                                 | <b>Unutil Electric</b><br>U Work with MADOT contractor - install conduits in existing duct bank/manholes<br>U Install permanent circuits in new conduit on new bridge<br>U Splice cables<br>U Remove temporary circuits<br>U Circuit Switching  | 1<br>2<br>3<br>1   |   |  |   |                     |  |
|                   |                                   | <b>Sub-Total</b>  | <b>8</b>   |   |  |   |                     |  |



| RESPONSIBLE PARTY   | DESCRIPTION - Utility Relocation Phases, Tasks and Activities   | Estimated Duration (Work Days) by Utilities (Lead time not included) | Concurrent / Exclusive Utility Work  |  |   |   | Access Restraint & Limitations of Operations Notes |                        |    |  |
|---|---|--|--|--|---|---|--|------------------------|----|--|
|   |   |  | Utility working with no other utilities in vicinity  | Utility working with other utilities on site | No Contractor physical construction operations on-site (while Utility is working) | Contractor and Utility are working on-site but NOT in the same vicinity | Potential Access Restraint (Yes/No)                | Reason/Note (optional) |    |  |
| C = Contractor<br>U = Utility Co.   | <p><b>Phase 2a</b></p> <p>Enabling work by the Contractor - Complete construction of Phase 1 as detailed on the plans. Install ITTCP for Phase 2 as detailed in plans. Coordinate R&amp;R of Light Pole at STA 29+35&amp;RT prior to bridge work. Install new drainage outfall prior to bridge work in this phase. This also should be done prior to any Verizon (American U-Tel) temp support system installation. Prior to the hold in place procedure Verizon needs to move cable from the old duct into the new duct (that will be held in place). MADOT Contractor to perform partial demolition of sidewalk and deck to expose Verizon conduits to allow for American U-Tel to provide temp support system (conceptual plan provided in plans). MADOT contractor to install temp earth support as needed for Verizon temporary support system prior to excavation and pile driving operations. Prepare site in preparation for hold in place temp support. Coordinate with American U-Tel during pile driving operations to shift conduit as needed. This will require continued communication between the MADOT contractor and American U-Tel.</p> <p><b>UTILITY OPERATIONS - Underground Verizon/American U-Tel</b></p> <p>U Place new ducts for new underground pathway connection</p> <p>U Place new CU cable stubs in older underground system</p> <p>U Place new CU cable stubs in older underground system</p> <p>U Place new CU cable stubs in newer underground system</p> <p>U Splice new CU cables underground/test</p> <p>U Place conduits to tie duct banks together</p> <p>U American U-Tel - Remove transite conduits, set up temp support</p> <p><b>Sub-Total</b></p> | 7  | X  |  |   |   | No   |                        |    |  |
|   |   | 8  | X  |  |   |   | No   |                        |    |  |
|   |   | 2  | X  |  |   |   | No   |                        |    |  |
|   |   | 45   | X  |  |   |   | No   |                        |    |  |
|   |   | 5  | X  |  |   |   | No   |                        |    |  |
|   |   | 45   | X  |  |   |   | No   |                        |    |  |
|   |   | <b>114</b>   |  |  |   |   |  |                        |    |  |
|   |   | C  | <p><b>Phase 2b</b></p> <p>Enabling work by the Contractor - MADOT contractor to provide and install utility bay cross frames. Verizon's contractor (American U-Tel) to provide and install conduits, associated conduit supports, pull wires through conduits and provide service. Coordinate with American U-Tel for removal of temp support beam and installation of final hanger assemblies prior to deck placement. Note: Contractor responsible for removal and disposal of old Verizon conduits.</p> <p><b>UTILITY OPERATIONS - Underground Verizon/American U-Tel</b></p> <p>U Trimout underground CU stubs, cables and equipment in older MHs</p> <p>U Remove underground CU stubs/Equipment</p> <p>U Remove underground CU cables in older underground system</p> <p>U Trimout underground CU cable in new MH's</p> <p>U Remove underground CU cables</p> <p>U American U-Tel - Remove temp support and final configure ducts</p> <p><b>Sub-Total</b></p> | 8  | X   |   |  |                        | No |  |
|   |   |  |  | 3  | X   |   |  |                        | No |  |
|   |   |  |  | 6  | X   |   |  |                        | No |  |
| 3   | X   |  |  |  |   |   | No   |                        |    |  |
| 2   | X   |  |  |  |   |   | No   |                        |    |  |
| 30  | X   |  |  |  |   |   | No   |                        |    |  |
| <b>52</b>   |   |  |  |  |   |   |  |                        |    |  |
| <b>IMPORTANT BASIS NOTES - FOR CONTRACTOR</b>   |   |  |  |  |   |   |  |                        |    |  |
| 1 Unless otherwise specified in the MassDOT Construction Contract, or unless specifically noted within this PUC form, the Utility durations shown herein are to be planned (within the CTD and by the Contractor) as unimpeded access to the Utility company to perform Utility relocations.  |   |  |  |  |   |   |  |                        |    |  |
| 2 "Concurrent Utilities" operations noted herein, are to signify those Utility Company operations that can be worked concurrently - MassDOT and the Contractor are to prepare NTPs to Utilities accordingly.  |   |  |  |  |   |   |  |                        |    |  |
| 3 "Potential Access Restraints" noted within this PUC Form are for planning purposes. See MassDOT Contract for Contractual Access Restraints (refer to Subsections 8.02, 8.03, and/or 8.06 for Design Bid Build Contracts and Volume II Section 9 for Design Build Contracts).  |   |  |  |  |   |   |  |                        |    |  |
| 4 Utility non-work periods - For planning purposes, the durations above contain some non work days (contingency) for New England conditions (precipitation, high temperatures, low temperatures, snow, ice). Gas line work however, typically has a seasonal restriction and can NOT be installed from 15-November to 15-March. Municipally Owned Electric and Gas Utilities are also restricted from proceeding from 15-November to 15-March. The Contractor shall (and the CTD plan) reflect this calendar restriction within the schedule (unless otherwise note).   |   |  |  |  |   |   |  |                        |    |  |
| 5 Access - Unless otherwise noted in the Contract, and in addition to the 'enabling' notes above, the Contractor must provide safe and unimpeded access (for trucks, lifts, cranes, etc.) to the Utilities, to allow for the proposed relocation(s) - including but not limited to snow removal, clearing and grubbing, guard rail removal, barrier removal, tree removal, and grading.   |   |  |  |  |   |   |  |                        |    |  |
| 6 For all MassDOT construction contracts issued after January 2014, the new Utility Coordination/documentation specification is required. This is Section 8.14 in Design-Bid-Build Contracts (see Design-Build index reference for applicable section #).   |   |  |  |  |   |   |  |                        |    |  |
| 7 Prior to starting any and all enabling work for Utilities, the Contractor is to plan in advance with submittals and approved durations.   |   |  |  |  |   |   |  |                        |    |  |
| 8 * Potential District Initiated Early Utility Relocation - if noted herein, the District reserves the right to initiate early utility relocation in advance of the Contract NTP. In submitting a bid price and in the development/basis of the Baseline Schedule, the Contractor shall not plan the Work with the potential benefit of this early utility relocation. As a requirement of the Baseline submission, unless otherwise noted in this Specification, the earliest that the first Utility company is to receive the 30 days advance notification to mobilize to the site, will be 7 calendar days after the pre-construction meeting and never sooner than 7 days after the Contract NTP. |   |  |  |  |   |   |  |                        |    |  |

THIS PAGE INTENTIONALLY LEFT BLANK



# WORK ZONE SAFETY

## *Temporary Traffic Control*

*Typical Details and  
Massachusetts Guidelines  
for MassDOT, Municipalities,  
Utilities, and Contractors*

**SHEET INDEX (1 OF 3)**

| <b><u>GENERAL</u></b>   | <b><u>PAGE</u></b> |
|---|--------------------|
| NOTES AND GUIDELINES.....   | 1-9                |
| FIG. 1: TYPICAL TRAFFIC CONTROL DEVICES.....  | 10                 |
| FIG. 2: PAVEMENT EDGE DROP-OFF GUIDANCE.....  | 11                 |
| FIG. 3: TYPICAL DEVICE SPACING; (AT 30 MPH).....  | 12-13              |
| FLAGGING GUIDANCE.....  | 14-15              |
| FIG. 4-5: TYPICAL PEDESTRIAN DEVICES.....   | 16-17              |
| <br><b><u>STATIONARY OPERATIONS</u></b>   |                    |
| FIG. 6: TWO LANE UNDIVIDED ROADWAY; HALF OF<br>ROADWAY CLOSED; WORK NEAR CURVE.....                                       | 18-19              |
| FIG. 7: TWO LANE UNDIVIDED ROADWAY; HALF OF<br>ROADWAY CLOSED.....  | 20-21              |
| FIG. 8: TWO LANE UNDIVIDED ROADWAY; SHOULDER<br>CLOSED.....   | 22-23              |
| FIG. 9: TWO LANE UNDIVIDED ROADWAY WITH<br>TRAVERSABLE SHOULDER; HALF OF ROADWAY CLOSED;<br>MAINTAIN TWO-WAY TRAFFIC..... | 24-25              |
| FIG. 10: FOUR LANE UNDIVIDED ROADWAY; RIGHT LANE<br>CLOSED.....   | 26-27              |
| FIG. 11: FOUR LANE UNDIVIDED ROADWAY; LEFT LANE<br>CLOSED.....  | 28-29              |
| FIG. 12: FOUR LANE UNDIVIDED ROADWAY; HALF OF<br>ROADWAY CLOSED.....  | 30-31              |
| FIG. 13: MULTILANE DIVIDED ROADWAY; RIGHT LANE<br>CLOSED.....   | 32-33              |
| FIG. 14: MULTILANE DIVIDED ROADWAY; LEFT LANE<br>CLOSED.....  | 34-35              |
| FIG. 15: MULTILANE DIVIDED ROADWAY; CENTER LANE OR<br>RIGHT/CENTER LANES CLOSED.....                                      | 36-37              |
| FIG. 16: MULTILANE DIVIDED ROADWAY; CENTER LANE OR<br>LEFT/CENTER LANES CLOSED.....                                       | 38-39              |

**SHEET INDEX (2 OF 3)**

| <b><u>STATIONARY OPERATIONS (CONT.)</u></b>   | <b><u>PAGE</u></b> |
|---|--------------------|
| FIG. 17: MULTILANE DIVIDED ROADWAY; RIGHT SIDE OF<br>OFF RAMP CLOSED.....                     | 40-41              |
| FIG. 18: MULTILANE DIVIDED ROADWAY; LEFT SIDE OF<br>OFF RAMP CLOSED.....                      | 42-43              |
| FIG. 19: MULTILANE DIVIDED ROADWAY; ROADWORK<br>BEYOND ON RAMP.....                           | 44-45              |
| FIG. 20: MULTILANE DIVIDED ROADWAY; ROADWORK<br>BEYOND OFF RAMP.....                          | 46-47              |
| FIG. 21: MULTILANE DIVIDED ROADWAY; TYPICAL RAMP<br>CLOSURE.....                              | 48-49              |
| FIG. 22: MULTILANE DIVIDED ROADWAY; TYPICAL<br>CLOVERLEAF RAMP CLOSURE.....                   | 50-51              |
| FIG. 23: MULTILANE DIVIDED ROADWAY; TYPICAL RAMP<br>CLOSURE; ADVANCE SIGNING.....             | 52-53              |
| FIG. 24: FOR MULTILANE DIVIDED ROADWAY; PLACEMENT<br>OF TEMPORARY PORTABLE RUMBLE STRIPS..... | 54-55              |
| <br><b><u>MOBILE OPERATIONS</u></b>   |                    |
| NOTES FOR MOBILE OPERATIONS.....  | 56                 |
| FIG. 25: ANY ROADWAY; BEYOND RIGHT SHOULDER.....  | 57                 |
| FIG. 26: ANY ROADWAY; SHOULDER.....   | 58                 |
| FIG. 27: DIVIDED ROADWAY; MEDIAN WORK.....  | 59                 |
| FIG. 28: UNDIVIDED TWO LANE ROADWAY; HALF OF<br>ROADWAY CLOSED.....                           | 60                 |
| FIG. 29: MULTILANE DIVIDED ROADWAY; LEFT LANE.....  | 61                 |
| FIG. 30: MULTILANE DIVIDED ROADWAY; RIGHT LANE.....   | 62                 |
| FIG. 31: MULTILANE DIVIDED ROADWAY; CENTER LANE.....  | 63                 |
| FIG. 32: POST-STORM CLEANUP OPERATION.....  | 64                 |

**SHEET INDEX (3 OF 3)**

| <b><u>EMERGENCY RESPONSE</u></b>  | <b><u>PAGE</u></b> |
|---|--------------------|
| NOTES FOR TRAFFIC EMERGENCY/INCIDENT OPERATIONS...                                | 65                 |
| FIG. 33: ANY ROADWAY; SHOULDER ENCROACHMENT.....                                  | 66                 |
| FIG. 34: TWO LANE ROADWAY; NO SHOULDER; TRAVEL<br>LANE ENCROACHMENT.....          | 67                 |
| FIG. 35: TWO LANE ROADWAY; TRAVERSABLE SHOULDER;<br>SINGLE LANE ENCROACHMENT..... | 68                 |
| FIG. 36: TWO LANE ROADWAY; TRAVERSABLE SHOULDER;<br>CENTER OF ROADWAY.....        | 69                 |
| FIG. 37: MULTILANE DIVIDED ROADWAY; RIGHT LANE.....                               | 70                 |
| FIG. 38: MULTILANE DIVIDED ROADWAY; LEFT LANE.....                                | 71                 |
| FIG. 39: MULTILANE UNDIVIDED ROADWAY; LEFT LANE.....                              | 72                 |
| FIG. 40: MULTILANE DIVIDED ROADWAY; MIDDLE LANE;<br>APPROACH FROM LEFT.....       | 73                 |
| FIG. 41: MULTILANE DIVIDED ROADWAY; MIDDLE LANE;<br>APPROACH FROM RIGHT.....      | 74                 |
| <br><b><u>TRAFFIC SIGNAL REPAIR WORK AT INTERSECTION</u></b>                      |                    |
| FIG. 42: MULTILANE UNDIVIDED ROADWAY; LEFTMOST OR<br>LEFT TURN LANE.....          | 75                 |
| FIG. 43: TWO LANE UNDIVIDED ROADWAY; ONE LEG OF<br>INTERSECTION.....              | 76                 |
| FIG. 44: MULTILANE UNDIVIDED ROADWAY; CENTER OF<br>INTERSECTION.....              | 77                 |
| <br><b><u>PEDESTRIAN DETAILS</u></b>  |                    |
| FIG. 45: PEDESTRIAN BYPASS.....   | 78                 |
| FIG. 46: TEMPORARY SIDEWALK CLOSURE.....  | 79                 |
| <br><b><u>BIKE LANE DETAILS</u></b>   |                    |
| FIG. 47: BIKE LANE CLOSURE.....   | 80-81              |

## INTRODUCTION

This guide has been prepared to assist in the planning and installing of temporary traffic controls in maintenance, utility, or short-term construction work areas (work lasting 10 hours or less). This guide serves to assist with the many decisions that must be made for each work site. Special planning for traffic control is necessary on a case by case basis because conditions can vary widely among work locations. **Since this guide cannot cover every situation, representative illustrations covering typical short-term construction, maintenance, and utility operations are presented.**

**All typical traffic control device setups illustrated should be considered as guides.** The traffic control devices that are shown, the arrangement or position of the devices, and the distances prescribed in the tables are based on the Federal Highway Administration's (FHWA) Manual on Uniform Traffic Control Devices (MUTCD) and the Massachusetts Amendments to the MUTCD (MA Amendments), but these illustrations only present minimum standards. The provision of safe work zones for all roadway users and roadway workers affected by these activities is paramount. Traffic controls may be expanded or improved upon whenever deemed necessary. Traffic movement through the work site all traffic control devices shall be periodically observed and inspected at all locations.

If necessary, Part 6 of the MUTCD and the MA Amendments, Chapter 17 (Work Zone Management) of MassDOT's Project Development & Design Guide, and the "Traffic Engineering and Safety Section" of the MassDOT web site: (<https://www.massdot.state.ma.us/highway/Departments/TrafficandSafetyEngineering.aspx>), as well as MassDOT District offices can provide additional guidance, information, and suggestions for work zone setups.

## RESPONSIBILITIES FOR TRAFFIC CONTROL

Short-term construction, maintenance, and utility work on or near the roadway creates a potentially hazardous situation, typically requiring the use of temporary traffic controls. These controls are important to protect both work crews and the road users. It is the responsibility of each maintenance foreman to establish and maintain safe and effective controls.

Usually the supervisor, working with the crew, plans the traffic control procedures for proposed work sites. The foreman is responsible for re-requesting, storing, and maintaining all traffic control devices necessary for their crews.

The foreman is responsible for placing the devices according to these guidelines. They must inspect each installation and observe traffic flow through the area. The foreman is generally authorized to make adjustments to the original installations that, in their judgment, are necessary to improve the control of traffic and establish greater safety.

All necessary traffic control devices must be installed before work begins and properly maintained during the work period. They must also be removed as soon as they are no longer relevant to the roadway conditions.

PAGE 2

In situations such as night time road or lane closures, detours, or other unusual conditions on state highways, the District Traffic Maintenance Engineer (DTME) should be advised. If the DTME is absent, the section foreman shall follow the instructions of the District Maintenance Engineer.

### **TRAFFIC CONTROL DEVICES**

Traffic control devices regulate the movement of road users, warn of unexpected or unusual roadway conditions, and inform them how to maneuver safely through or around the work area. All signs, channelizing devices, barricades, and other miscellaneous traffic control devices should work together to guide traffic safely and efficiently. Common temporary traffic control devices are outlined and described below.

#### **Signs**

Temporary traffic control zone (TTCZ) signs are the primary means of providing information and directions to roadway users. All signs must be retroreflective per MassDOT's latest standard.

Warning signs call attention to unexpected conditions and to situations that might not be readily apparent to road users on or adjacent to a roadway. Warning signs alert road users to conditions that might call for a reduction of speed or an action in the interest of safety and efficient traffic operations. Nearly all warning signs for construction and work areas have black legends and borders on a fluorescent orange background.

Regulatory signs shall be used to inform road users of selected traffic laws or regulations and indicate the applicability of the legal requirements. Regulatory signs typically have black legends and borders on a white background.

#### **Channelizing Devices**

When used properly, traffic cones, reflectorized plastic drums, and barricades guide traffic through the work area along an appropriate travel path. It takes roadway users a certain distance along the roadway to safely move away from the upcoming active work site. These transition distances are based on the following taper length (L) formulas:

$L = WS^2/60$  for speeds of 40 mph or less; or

$L = WS$  for speeds of 45 mph or more; where

- $L$  = minimum length of taper in feet,
- $S$  = posted speed limit or typical travel speed in miles per hour prior to the work, and
- $W$  = width of lane closure in feet.

The spacing of channelizing devices (in feet) is approximately equal to the existing speed of traffic (in mph).

#### **Warning Lights**

Rotating beacons and other flashing lights mounted on work vehicles, signs, or channelizing devices help alert roadway users to the work area. They may also be used to warn roadway users of hazards within the work area. The first 10 drums in any taper shall be equipped with sequential flashing lights.



### **Arrow Boards**

Arrow boards are a special type of sign that are highly visible work zone warning devices. They are particularly effective on highways, where both speed and volume are high. Arrow boards in the non-directional, CAUTION, mode (four corner flashing) may be used to indicate that a shoulder is closed. Arrow boards in the arrow mode shall only be used when a travel lane is dropped on a multi-lane road and one lane of traffic must merge with another. All arrow boards should be located at the beginning of each lane or shoulder closure taper without extending outside of it. Arrow boards shall flash at a rate of 25 to 40 flashes per minute. Arrow boards shall not be used to indicate a lane shift.

### **BASIC REQUIREMENTS**

In every work situation, the temporary traffic control setup must: Give roadway users sufficient advance warning of the work area; advise roadway users of the proper actions to take and travel paths to follow; and provide protection to roadway users, workers, and the work area. These three general requirements can be met as outlined below.

#### **Provide Advance Warning**

Warning devices along the approaches to a work area alert roadway Users to changes to road and operating conditions. Roadway users are usually alerted to these dangers via a sign or series of signs installed in the same order as the roadway user generally would expect to see them on long-term construction projects.

The initial project limit sign is usually a general warning such as "ROAD WORK 1500 FT". Other operational warning signs then provide the roadway user with more specific information about the situation. A minimum of three advance warning signs (the initial project limit sign and two operational warning signs) is recommended when work is located on the traveled way. Warning lights and flags can be used to attract attention to the signs. A highly visible work area helps reinforce the advance warnings.

#### **Advise and Direct Travelers**

Operational warning signs provide information to the road-way user such as the type of work being performed, special conditions to watch for, or actions to take. These include signs such as, SHOULDER WORK, RIGHT LANE CLOSED, DETOUR 500 FT, ROAD CLOSED to THRU TRAFFIC, POLICE OFFICER AHEAD, etc. All of these signs must be located far enough in advance of the work area that the roadway user has sufficient time to react to them appropriately. For projects in Urban Areas, see detail: Typical Device Spacing for minimum sign spacing.

#### **Protect Travelers, Workers, and the Work Area**

The primary protection of any work area is its own visibility. Traffic cones, reflectorized plastic drums, portable breakaway barricades, etc. are used to make the work area visible and separate workers from traffic.

PAGE 4

Other devices, such as flashing lights, flags, delineators, temporary lighting, and portable changeable message signs (PCMS) can be used to provide additional emphasis and visibility.

Workers must protect themselves by being alert to their work situation, wearing safety vests and hard hats, and by facing traffic whenever possible.

Work vehicles can also add protection when they are equipped with truck mounted attenuators, rotating beacons, flashing lights, flashing arrow boards, etc. and are parked between workers and oncoming traffic. However, workers should not position themselves between two closely parked vehicles. No private personal vehicles are allowed within the work site.

### PLANNING GUIDELINES

Decisions regarding selection of work area traffic control devices require a knowledge and understanding of the specifics of each work zone. As there may be vast differences between situations, three main variables need to be considered prior to determining the need for, or the selection of, traffic control devices: 1) location of work, 2) type of roadway, and 3) speed of traffic.

Compiling information about these variables will help with planning a safe work area control. Each of these variables is explained below.

#### Location of Work

The choice of traffic controls needed for a short-term construction, maintenance, or utility operation depends upon the work zone's location. As a general rule, the closer the active work site is to the roadway, the more control devices are needed. Work can take place:

- Away from the shoulder or edge of pavement. No special devices are needed if work is confined to an area 15 or more feet from the edge of the shoulder. A general warning sign, such as ROAD WORK AHEAD, should be used if workers and equipment must occasionally move closer to the roadway.
- On or near the shoulder/ edge of pavement. This area should be signed as if work were on the road itself, since it is part of the roadway users' recovery area. Advance warning and operational signs are needed, as well as channelization devices to direct traffic and keep the work area visible to roadway users.
- On the median of a divided highway. Work in this location may require traffic control in both directions of traffic. Advance warning and channelization devices should be used if the median is narrow.
- On the roadway. This condition requires detailed protection for workers and sufficient warning to roadway users. Advance warning must provide a general message that work is taking place as well as information about specific hazards and specific actions the roadway user must take.

## TYPE OF ROADWAY

The characteristics of the roadway also have an important influence on the selection of work area traffic control. The roadway, itself, may present special hazards. You should plan for maximum protection, using the worst hazard present as your guide to signing the work area. Some general considerations are described below for road conditions.

**One-way roads:** A one-way road requires signage on both sides of the road if it carries two or more lanes in one direction, ensuring roadway users in all lanes are alerted and informed.

### Two-way roads:

- **Undivided:** Two-way, undivided roads will usually require controls for both directions of traffic. When the active work site is well off the roadway, controls for the opposite lane may be eliminated.
- **Divided:** Work on divided multi-lane roadways can often be handled as work along a one-way road (i.e. signs are provided along both sides of the roadway along the direction affected). If the work is in the median, both directions of traffic must be controlled, and both approaches should be double signed (i.e. have all 3 advance warning signs on both sides of each direction).

## EFFECTS OF SPEED ON WORK ZONES

Speed is an important consideration in the use of work area traffic control devices. As a general rule, the greater the speed of traffic approaching a work area, the greater the size, number, and spacing of control devices.

**Size.** The standard size for most warning signs is 36 x 36 inches on conventional roadways and 48 x 48 inches on freeways and expressways. Signs larger than the standard 36 x 36 inches may be desirable on high-speed conventional roads.

**Position.** Install signs far enough in advance of the work area so the roadway users have time to react to them (see charts associated with diagrams for spacing).

## OTHER FACTORS

**Sight Obstructions.** To ensure safety, work areas must be visible. Assess the placement of the temporary traffic control devices by driving through the area, and determine if the devices can be easily seen and provide sufficient time for roadway users to react in a safe manner. Extra precaution should be enacted in areas where horizontal or vertical curves may obstruct a roadway user's clear view of road activities ahead.

**Police/Flaggers.** It should be noted that the MUTCD does not require police/flaggers for stationary setups. If police/flaggers are used, a police/flagger ahead sign should be used in advance of any point where the police/flagger is stationed to control road users.

## PROCEDURES FOR WORK AREA TRAFFIC CONTROL

### 1. PLAN YOUR WORK

**Inspect** location of work area and its surroundings.

#### **Analyze:**

- Location of work in relation to the traveled way, intersecting road-ways, driveways, and sight distances;
- Type of roadway and traffic involved; and
- Volume and speed of traffic.

**Meet and discuss** the work and necessary traffic control with the crew.

**Study** representative illustrations in this guide to develop a temporary traffic control plan (TTCP).

#### **Other Considerations:**

- Base your traffic control plan on the premise that all roadway users are unfamiliar with the area.
- The closer the work area location is to traffic, the more controls are needed.
- Plan for maximum protection.
- Select and inspect the temporary control devices needed (including all warning signs), if they are not in good condition, REPLACE THEM!
- Then collect and transport them to the work site.
- Determine their proper placement.
- Install signs and other traffic control devices prior to allowing personnel or equipment onto the roadway.
- Make sure signs are reflective, accurate, clean, and meet specifications. Completely cover any existing permanent signs that will conflict with the messages of the new work area control signs.

### 2. INSTALLING/REMOVING TEMP. TRAFFIC CONTROL DEVICES

Care must be exercised when installing and removing temporary traffic control (TTC) devices. The traffic control needed to perform the operation safely is dictated by the location on the roadway the operation will occur: in a shoulder or a lane, in the left lane or right, etc. In all cases, installing TTC begins and ends as a mobile operation.

A shadow vehicle with a truck mounted attenuator (TMA) shall be used to protect workers installing and removing TTC devices on all roadways with a posted speed limit of 45 MPH or greater as directed by the engineer. TTC devices shall not be installed or removed from a shadow vehicle with a TMA. TTC devices shall be installed or removed from a work operation vehicle only and a shadow vehicle with a TMA shall be used to protect the workers installing or removing the devices.

## **PROCEDURES FOR WORK AREA TRAFFIC CONTROL (CONT.)**

### **3. INSTALL TRAFFIC CONTROL DEVICES AT WORK SITE FOR LOWER SPEED ( $\leq 40$ MPH) ROADWAYS:**

- 1) All devices shall be installed in order with the flow of traffic.
- 2) Where one direction of traffic is being affected, the first sign installed should be the sign farthest from the work site, and on the same side as the work.
- 3) Where two directions of traffic are affected, install signs for opposing traffic first, starting with the sign farthest from the work area. When signs for opposing traffic have been installed, install signs on the same side as the work area, again beginning with the sign farthest from the active work site.
- 4) Once signs are in place, other traffic control devices shall be installed in the same manner as the signs.

### **FOR HIGHER SPEED ( $\geq 45$ MPH) ROADWAYS:**

- 1) All devices shall be installed in order with the flow of traffic.
- 2) Install all advance warning signs, beginning with the ROAD WORK XXX (W20-1) sign and ending with the END ROAD WORK/DOUBLE FINES END (MA-R2-10E) sign.
- 3) Install all signs beginning with the opposite side which will be closed (for a right lane closure; first, install all signs on the left side (shoulder) and then install all signs on the right side (shoulder). No signs shall be erected on the roadway unless delineated by traffic control devices.
- 4) If required, install shoulder taper as the mobile operation advances.
- 5) Install arrow board on the shoulder prior to the merging taper or as close to the beginning of the merging taper as possible.
- 6) Install channelizing devices to form a merging taper. Use of a shadow vehicle with a TMA during installation is required on roads with speed limits of 45 MPH or greater or as directed by the Engineer.
- 7) Install traffic control devices along the buffer space at the appropriate spacing.
- 8) Continue placing devices along the work space at the appropriate spacing.
- 9) Install devices for the termination area as necessary.
- 10) Place the shadow vehicle with a TMA in advance of the first work crew or hazard approached by motorists. Multiple shadow vehicles may be required based on the number of lane and shoulder closures implemented.

### **4. INSPECT WORK AREA SIGNING AND CONTROL DEVICES**

- 1) Assess the placement of the temporary traffic control devices by driving through the work area. All approaches to the work zone should be checked.
- 2) Ensure roadway users will have sufficient time to read signs and react in a safe manner.

### PROCEDURES FOR WORK AREA TRAFFIC CONTROL (CONT.)

- 3) Check visibility of entire work area. If approaching roadway users can't see the work area well, or if they can't see ahead to traffic that may already be queued on the approach because of the work, additional traffic control devices should be deployed.
- 4) Check to ensure the proper temporary traffic control devices are positioned to protect workers from traffic (where possible).
- 5) Ensure all workers wear safety vests, hard hats, and all other necessary safety equipment. All worker safety gear should be in good condition. All reflective gear should be clean and highly visible in the dark.
- 6) Record in the log book the number and location of all signs and devices.

#### Considerations:

- Work area signs should never be blocked from view or obscured by vegetation, existing signs, or other obstructions.
- Flags, flashing lights, and edge line traffic cones can be used to improve visibility.

### 5. REMOVE TRAFFIC CONTROL DEVICES AT WORK SITE

**All workers and equipment should be clear from work site BEFORE removing signs and other devices.**

#### FOR LOWER SPEED ( $\leq 40$ MPH) ROADWAYS:

- 1) Remove signs and other devices within the delineated area when work is complete.
- 2) Remove other traffic control devices in the reverse order in which they were installed
- 3) Remove signs in the reverse order in which they were installed (i.e. sign closest to the work area to be removed first).
- 4) When the operation is complete, uncover any existing permanent signs covered in Step 2.
- 5) Record in the log book the time at which the signs were removed.

#### FOR HIGHER SPEED ( $\geq 45$ MPH) ROADWAYS:

All TTC devices for a stationary lane closure on a multi-lane roadway, except advance warning signs, should be removed against the flow of traffic in the following sequence:

- 1) Remove the channelizing devices starting from the end of the activity area working back to the widest part of the merging taper.
- 2) A shadow vehicle with TMA shall be positioned to protect workers removing devices and work backwards as the setup is removed from the roadway.

### PROCEDURES FOR WORK AREA TRAFFIC CONTROL (CONT.)

- 3) Place the removal vehicle on the shoulder, and remove the channelizing devices from the merging taper by hand onto the work vehicle.
- 4) Remove the arrow board once traffic is clear and it is safe to do so.
- 5) Circle back and moving with the flow of traffic, remove the advance warning signs starting with the opposite side from previous lane closure first.
- 6) At no time shall workers run across the multilane roadway to remove signs on both sides of the road simultaneously.
- 7) Record in the log book the time at which the signs were removed

### RAMP FACILITIES

At all times it is necessary to control the on and off-ramp traffic during the installation and breakdown of traffic control devices. Use of temporary traffic slow-downs or rolling roadblocks is recommended to allow for the safety of workers handing temporary traffic control devices on ramp facilities. A shadow vehicle with a TMA shall be used to protect the workers installing or removing the devices. At no time shall the work operation vehicle be used as the shadow vehicle with the TMA.

### USE OF THIS GUIDE

Illustrations showing minimum standards for short-term construction, maintenance, and utility operations are arranged in this guide by type of operation. The users of this guide should compare all illustrated examples and examine their differences. After gathering information about the work zones using the general guidelines as outlined, proceed as follows:

- 1) Turn to the Index. Consider the type of operations and the type of roadway upon which work will occur.
- 2) Select the figure that most closely matches the conditions where you plan to work. Remember that all diagrams represent minimum standards.
- 3) Read the title of the illustration to ensure that it is appropriate to your location. Study the layout of traffic control devices and read all notes.
- 4) Consult the appropriate tables, as directed on each illustration to determine taper length and proper spacing of signs. Notice that distances change when speeds change. Also note that these are guidelines, only, and they must be adapted to your specific work area.
- 5) Use the **“PROCEDURES FOR WORK AREA TRAFFIC CONTROL”** for assistance in completing all necessary steps to provide effective and safe work area traffic control.



**SIGN**

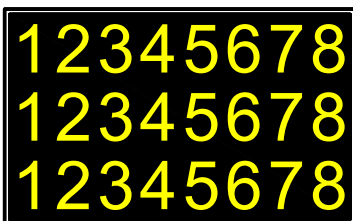

**PORTABLE CHANGEABLE MESSAGE SIGN (PCMS)**

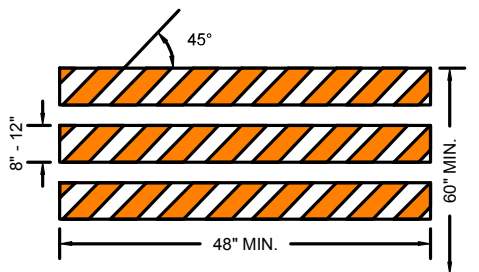

**TYPE III BARRICADE**

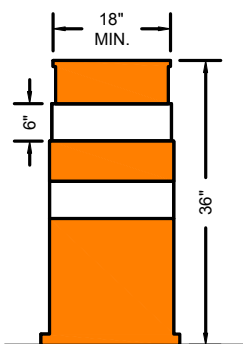

**DRUM**

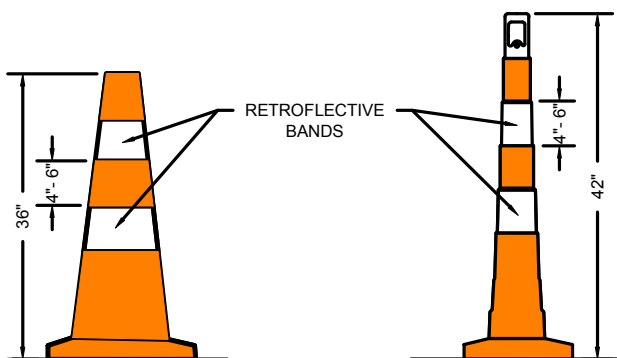

**CONES**

Cones may be used for all daytime operations. For night work, drums should be used to form the taper(s) and cones can be used along the tangent section of the work setup.

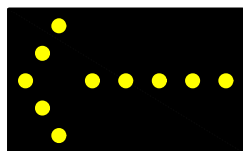

**LEFT**

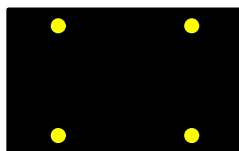

**CAUTION**

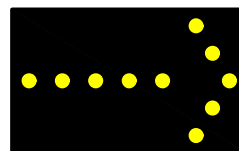

**RIGHT**

**ARROW BOARD (WITH MODE)**

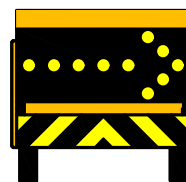

**TRUCK MOUNTED ATTENUATORS**

Truck Mounted Attenuators (TMA) shall be positioned between the start of the work area and the end of the designated buffer zone. The TMAs are to be positioned in each temporarily closed lane. This includes shoulders ( $\geq 8$  feet) whether combined with a travel lane closure or being closed alone. These TMA conditions are required on roadways with speeds of 45 MPH or greater. TMAs can be used on other roadways at the discretion of the engineer. TMAs shall be used for the deployment and removal of all traffic control devices, including all advance warning signs.



### SHORT-TERM PAVEMENT EDGE DROP-OFFS

*Note that this guidance is adopted from the Roadside Design Guide, 4th Edition.*

Pavement drop-offs may occur during paving, excavation, and other construction activities. Drop-offs create hazards for vehicles if not properly mitigated. The following applies for all roads with speed limits greater than 30 mph; for roads with speed limits of 30 mph or less, treatments for pavement edge drop-offs are at the discretion of the Engineer. Drop-offs between adjacent, open travel lanes should not exceed 2", and any drop-off in excess of 3" should not be left unattended without one of these mitigation measures applied.

- Shoulder drop-offs 3" or less adjacent to a shoulder or active travel lane should be mitigated by:
  - ✓ A W8-9 (LOW SHOULDER) sign in advance of and at regular intervals throughout the treatment; or
  - ✓ The placement of drums on the traffic side of the drop-off.

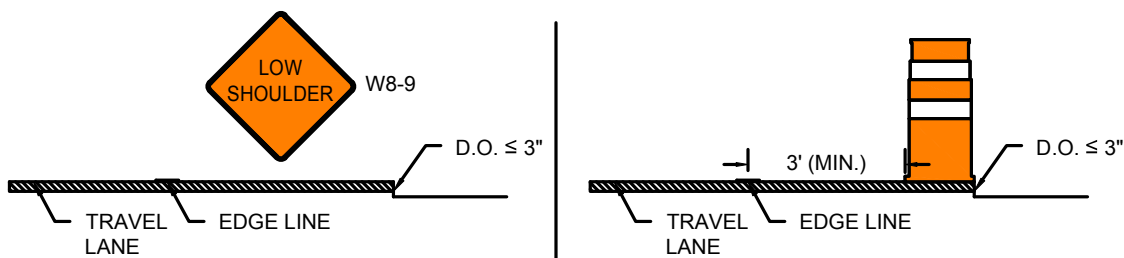

- Shoulder drop-offs greater than 3" but less than or equal to 36" should be mitigated by:
  - ✓ A W8-9 (LOW SHOULDER) sign in advance of and at regular intervals throughout the treatment and the placement of drums on the traffic side off the drop-off, offset at least 3' from the travel lane; or
  - ✓ A W8-9 (LOW SHOULDER) sign in advance of and at regular intervals throughout the treatment and the placement of a temporary wedge of material along the face of the drop-off. The wedge should consist of stable material placed on a 2H:1V or flatter slope.

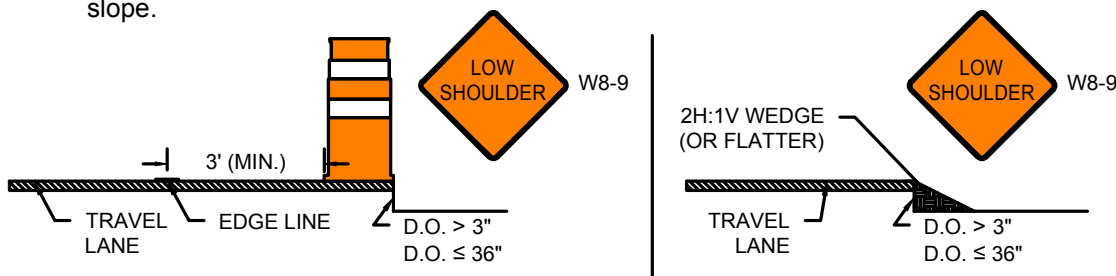

- Shoulder drop-offs greater than 36" must be protected by temporary barrier.

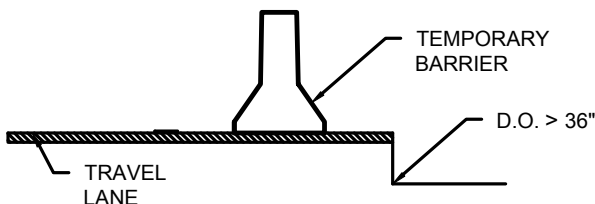



| POSTED SPEED LIMIT (MPH) | SPACING FOR ADVANCE WARNING SIGNS (FT) (A,B,C) | CHANNELIZATION DEVICES (DRUMS OR CONES) |                         |                     |                   |
|--------------------------|--|---|-------------------------|---------------------|-------------------|
|                          |  | TRAVEL LANE CLOSURE LENGTH (L) (FT)     | BUFFER ZONE LENGTH (FT) | DEVICE SPACING (FT) | MIN # OF DEVICES* |
| 25-40                    | 500 / 500 / 500                                | 320                                     | 305                     | 20                  | 55                |
| 45-55                    | 500 / 1000 / 1000                              | 660                                     | 495                     | 40                  | 40                |
| 60-65                    | 1000 / 1600 / 2600                             | 780                                     | 645                     | 40                  | 50                |









\* NUMBER OF DEVICES BASED ON 400 FT WORK ZONE.

| MINIMUM SPACING OF ADVANCE WARNING SIGNS FOR URBAN ROADWAYS |                        |
|---|------------------------|
| ROAD TYPE   | DISTANCE BETWEEN SIGNS |
| URBAN (LOW SPEED)   | 100 FT                 |
| URBAN (HIGH SPEED)  | 350 FT                 |

**NOTES**

1. 40 FT = 10 FT PAVEMENT MARKING + 30 FT SKIP

**LEGEND**

-  WORK ZONE
-  CHANNELIZATION DEVICE
-  FLASHING ARROW BOARD
-  PORTABLE CHANGEABLE MESSAGE SIGN
-  TRUCK MOUNTED ATTENUATOR
-  RADAR SPEED FEEDBACK BOARD
-  POLICE DETAIL OR UNIFORMED FLAGGER
-  TEMPORARY PORTABLE RUMBLE STRIP
-  TYPE III BARRICADE

NOT TO SCALE

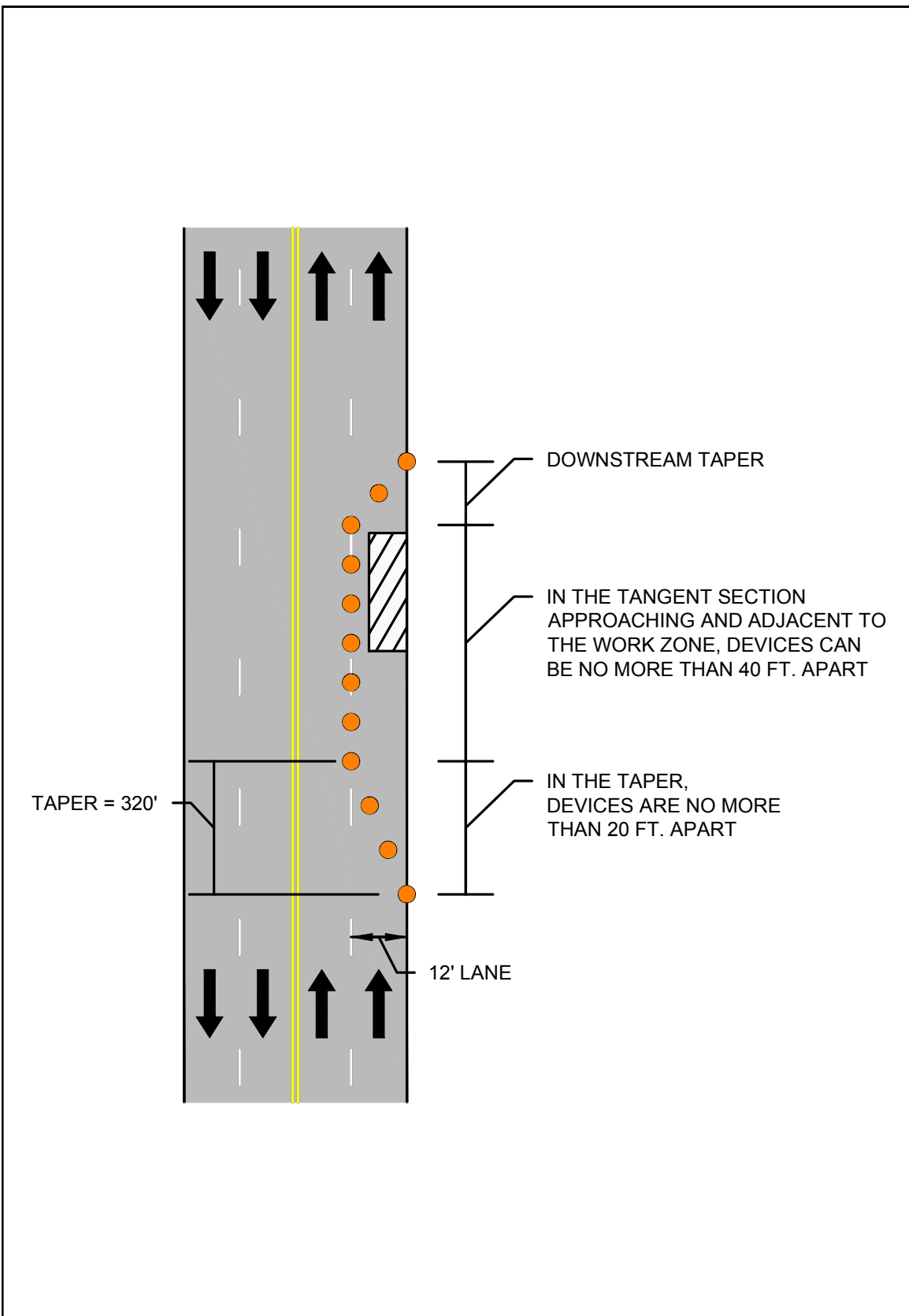

|  |   |                          |
|--|---|--------------------------|
|  <p>PAGE 14</p> | <p>Work Zone Safety<br/>Standard Details<br/>and Drawings</p> | <p>FLAGGING GUIDANCE</p> |
|--|---|--------------------------|

**Guidance for Flagging Operations**

**NOTE:**

A flagger shall always be aware of their surroundings and have a good escape route. A flagger shall never be positioned directly beside or against construction equipment. When a flagger is required to direct traffic in an area where the escape route is partially blocked by a traversable obstruction such as a guardrail, the flagger shall be physically capable of traversing that obstruction. Prior to commencing a project, the supervisor in charge shall review the project, including guardrail areas, for safe flagging stations. The supervisor in charge shall clearly communicate with the flagger(s), indicating any locations where they cannot safely perform their duties.

Each flagger shall be equipped with the following high visibility clothing, signaling, and safety devices:

- 1) A white protective hard hat with a minimum level of reflectivity per the requirements of ANSI, Type I, Class E&G;
- 2) A clean, unfaded, untorn lime/yellow reflective safety vest and pants meeting the requirements of ANSI 107 Class 3 with the words "Traffic Control" on the front and rear panels in minimum two (2) inch (50 millimeter) high letters;
- 3) A 24 inch "STOP/SLOW" traffic paddle conforming to the requirements of Part 6E.03 of the Manual on Uniform Traffic Control Devices (MUTCD), a weighted, reflectorized red flag, flagger station advance warning signage, and two-way radios capable of providing clear communication within the work zone between flaggers, the Contractor, and the Engineer. The traffic paddle shall be mounted on a pole of sufficient length to be seven feet above the ground as measured from the bottom of the paddle;
- 4) A working flashlight with a minimum of 15,000 candlepower and a six inch red attachable wand, a whistle with a working lanyard, and a First Aid kit that complies with the requirements of ANSI Z308.1; and
- 5) An industrial/safety type portable air horn that complies with the requirements of the U.S. Coast Guard.

A "STOP/SLOW" paddle should be the primary hand-signaling device. It shall have an octagonal shape on a rigid handle. Flag use should be limited to emergency situations.



**Properly Trained Flaggers**

- Give clear messages to drivers.
- Allow distance for drivers to react.
- Coordinate with other flaggers.
- Use standard signaling methods.

**Properly Equipped Flaggers**

- Use approved stop/slow paddles.
- Use approved safety apparel.
- Use retroreflective equipment.
- Use hand held radios, as needed.
- All flaggers shall wear safety apparel that meets ANSI Class 3 requirements. The combination of vest and pants is required.

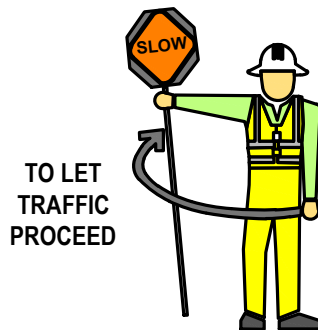

**Proper Flagging Stations**

- Good approach sight distance.
- Highly visible to traffic.
- Stand alone away from other machinery and people.
- Stand on right edge of pavement or shoulder- proceed to centerline only when first vehicle has come to stop.
- Have a good escape route.



**Proper Advance Warning Signs**

- Always use warning signs.
- Allow for reaction distance from signs.
- Remove signs if no longer necessary or not flagging.
- Use free hand in up-and-down motion to help slow traffic.



|  |   |  |
|--|---|--|
|  <p>PAGE 16</p> | <p>Work Zone Safety<br/>Standard Details<br/>and Drawings</p> | <p style="text-align: center;"><b>FIGURE 4</b><br/><b>TYPICAL PEDESTRIAN DEVICES</b><br/><b>(1 OF 2)</b><br/><b>NOT TO SCALE</b></p> |
|--|---|--|

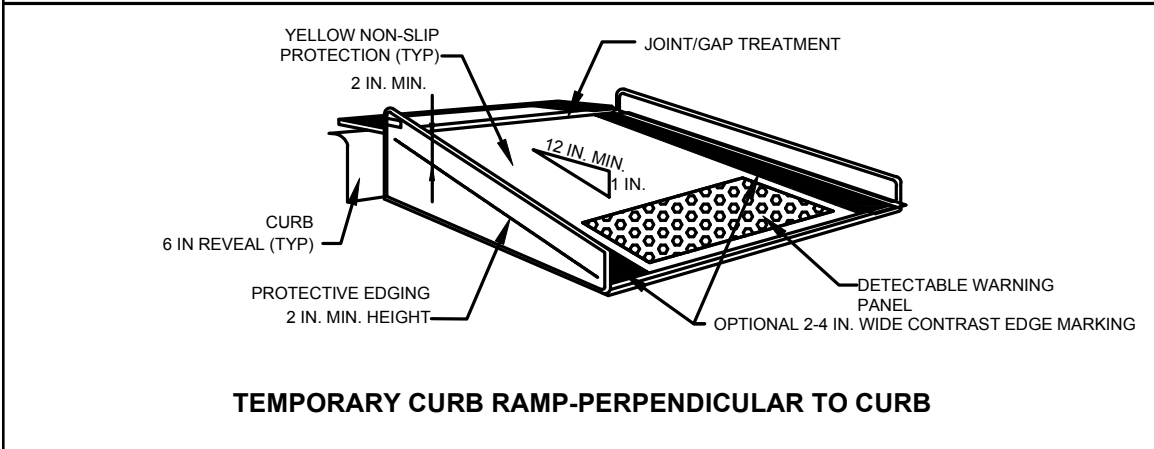
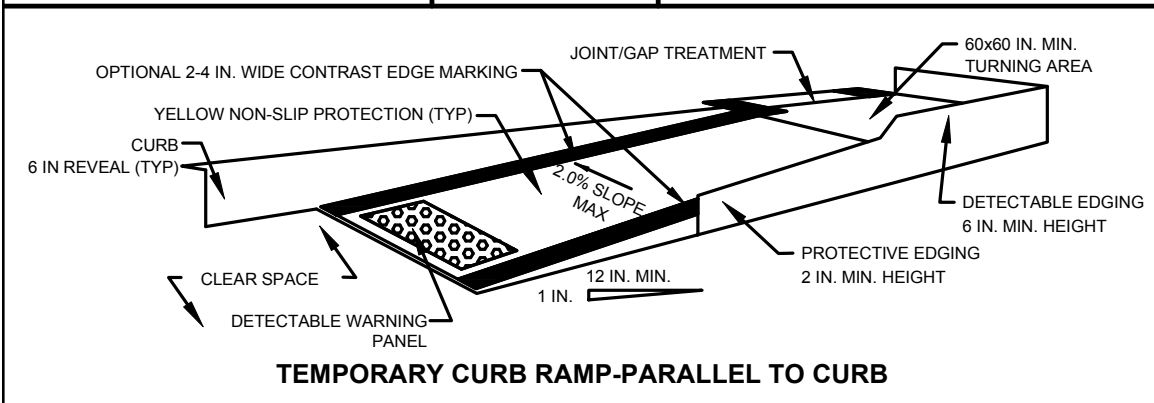

**NOTES:**

1. CURB RAMPS SHALL BE 60 IN. MINIMUM WIDTH WITH A FIRM, STABLE, AND NON-SLIP SURFACE.
2. PROTECTIVE EDGING WITH A 2 IN. MINIMUM HEIGHT SHALL BE INSTALLED WHEN THE CURB RAMP OR LANDING PLATFORM HAS A VERTICAL DROP OF 6 IN. OR GREATER OR HAS A SIDE APRON SLOPE STEEPER THAN 1:3 (33%). PROTECTIVE EDGING SHOULD BE CONSIDERED WHEN THE CURB RAMPS OR LANDING PLATFORMS HAVE A VERTICAL DROP OF 3 IN. OR MORE.
3. PROTECTABLE EDGING WITH 6 IN. MINIMUM HEIGHT AND CONTRASTING COLOR SHALL BE INSTALLED ON ALL CURB RAMP LANDINGS WHERE THE WALKWAY CHANGES DIRECTION (TURNS).
4. THE CURB RAMP WALKWAY AND LANDING AREA SURFACE SHALL BE OF A SOLID CONTINUOUS CONTRASTING COLOR ABUTTING UP TO THE EXISTING SIDEWALK.
5. CURB RAMPS AND LANDINGS SHOULD HAVE A 1:50 (2%) MAX CROSS-SLOPE.
6. CLEAR SPACE OF 48x48 IN. MINIMUM SHALL BE PROVIDED ABOVE AND BELOW THE CURB RAMP.
7. WATER FLOW IN THE GUTTER SYSTEM SHALL HAVE MINIMAL RESTRICTION.
8. LATERAL JOINTS OR GAPS BETWEEN SURFACES SHALL BE LESS THAN 0.5 IN. WIDTH.
9. CHANGES BETWEEN SURFACE HEIGHTS SHOULD NOT EXCEED 0.5 IN. LATERAL EDGES SHOULD BE VERTICAL UP TO 0.25 IN. HIGH, AND BEVELED AT 1:2 BETWEEN 0.25 IN. AND 0.5 IN. HEIGHT.
10. IF A TEMPORARY PEDESTRIAN RAMP LEADS TO A CROSSWALK, THEN A DETECTABLE WARNING PAD MUST BE ADHERED TO THE BASE OF THE RAMP. IF IT LEADS TO A PROTECTED PEDESTRIAN BYPASS THAT DOES NOT CONFLICT WITH VEHICULAR TRAFFIC, THEN A PAD SHALL NOT BE INSTALLED ON THE RAMP.

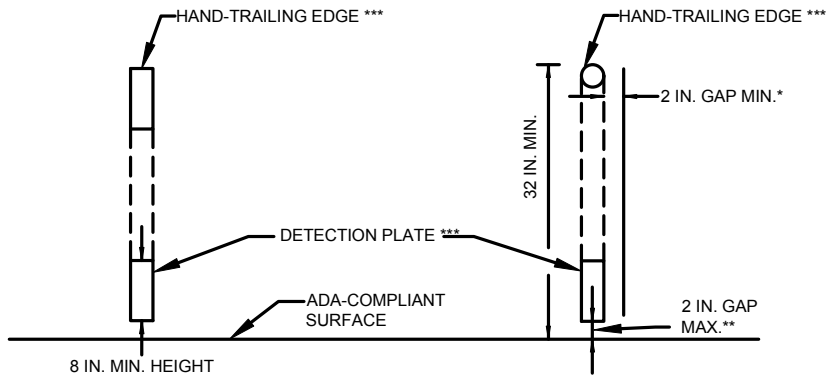

**CROSS SECTION VIEW**

**PEDESTRIAN CHANNELIZING DEVICE**

- \* THERE SHALL BE A 2 INCH GAP BETWEEN THE HAND-TRAILING EDGE AND ITS SUPPORT.
- \*\* A MAXIMUM 2 INCH GAP BETWEEN THE BOTTOM OF THE BOTTOM RAIL AND THE SURFACE MAY BE USED TO PROVIDE DRAINAGE.
- \*\*\* THE HAND-TRAILING EDGE AND DETECTION PLATE SHALL BE CONTINUOUS THROUGHOUT THE LENGTH OF THE PATH SUCH THAT A PEDESTRIAN USER WITH A LONG CANE CAN FOLLOW IT.

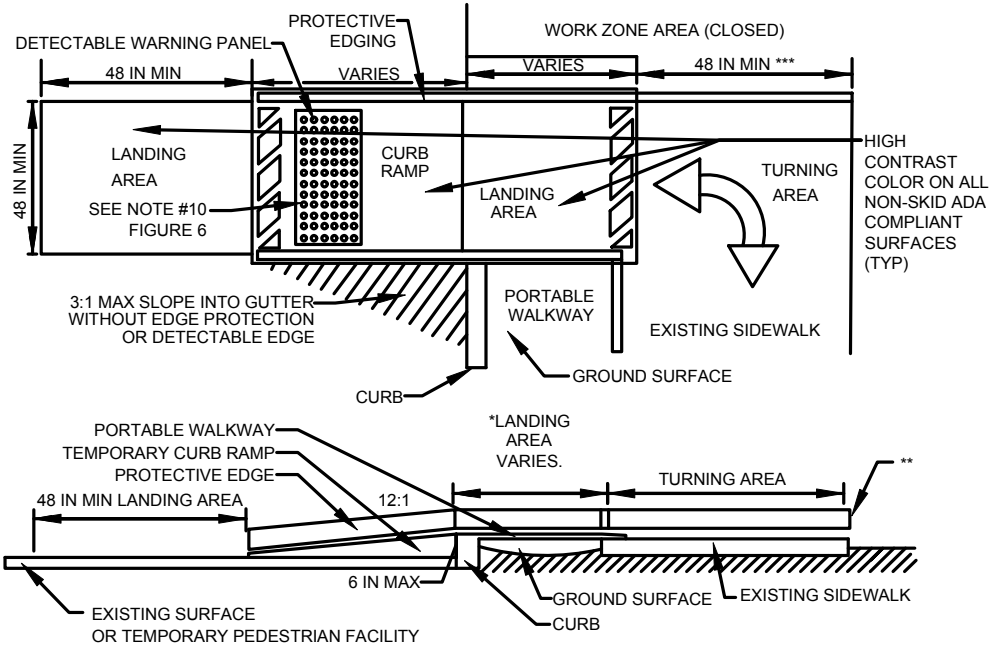

**TEMPORARY CURB RAMP**

- \* LANDING AREA USED TO OVERLAP NON-ADA COMPLIANT SURFACES.
- \*\* DETECTABLE EDGE REMOVED IF A CONTINUOUS SIDEWALK.
- \*\*\* 60 IN. IF AN OBSTRUCTION IS AT BACK OF SIDEWALK.

|   |  |  |
|---|--|--|
| <br>Massachusetts Department of Transportation<br>Highway Division | Work Zone Safety<br>Standard Details<br>and Drawings | FIGURE 5<br>TYPICAL PEDESTRIAN DEVICES<br>(2 OF 2)<br>NOT TO SCALE |
| PAGE 17   |  |  |



PAGE 18

Work Zone Safety  
Standard Details  
and Drawings

STATIONARY OPERATIONS  
TWO LANE UNDIVIDED ROADWAY  
HALF OF ROADWAY CLOSED  
WORK NEAR CURVE









| POSTED SPEED LIMIT (MPH) | SPACING FOR ADVANCE WARNING SIGNS (FT) (A,B,C) | CHANNELIZATION DEVICES (DRUMS OR CONES) |                         |                     |                   |
|--------------------------|--|---|-------------------------|---------------------|-------------------|
|                          |  | TRAVEL LANE CLOSURE LENGTH (L) (FT)     | BUFFER ZONE LENGTH (FT) | DEVICE SPACING (FT) | MIN # OF DEVICES* |
| 25-40                    | 500 / 500 / 500                                | 50                                      | 100                     | 20                  | 30                |
| 45-55                    | 500 / 1000 / 1000                              | 100                                     | 150                     | 40                  | 20                |

\* NUMBER OF DEVICES BASED ON 400 FT WORK ZONE.

**NOTES**

1. IF POLICE DETAIL/UNIFORMED FLAGGER SUPPORT IS REQUIRED, PROVIDE TWO UNITS.
2. MA-R2-10a LOCATED AT C/2.
3. \*\* = EXTEND ENOUGH SO TAPER IS BEFORE CURVE

**LEGEND**

-  WORK ZONE
-  CHANNELIZATION DEVICE
-  FLASHING ARROW BOARD
-  PORTABLE CHANGEABLE MESSAGE SIGN
-  TRUCK MOUNTED ATTENUATOR
-  RADAR SPEED FEEDBACK BOARD
-  POLICE DETAIL OR UNIFORMED FLAGGER
-  TEMPORARY PORTABLE RUMBLE STRIP
-  TYPE III BARRICADE

NOT TO SCALE



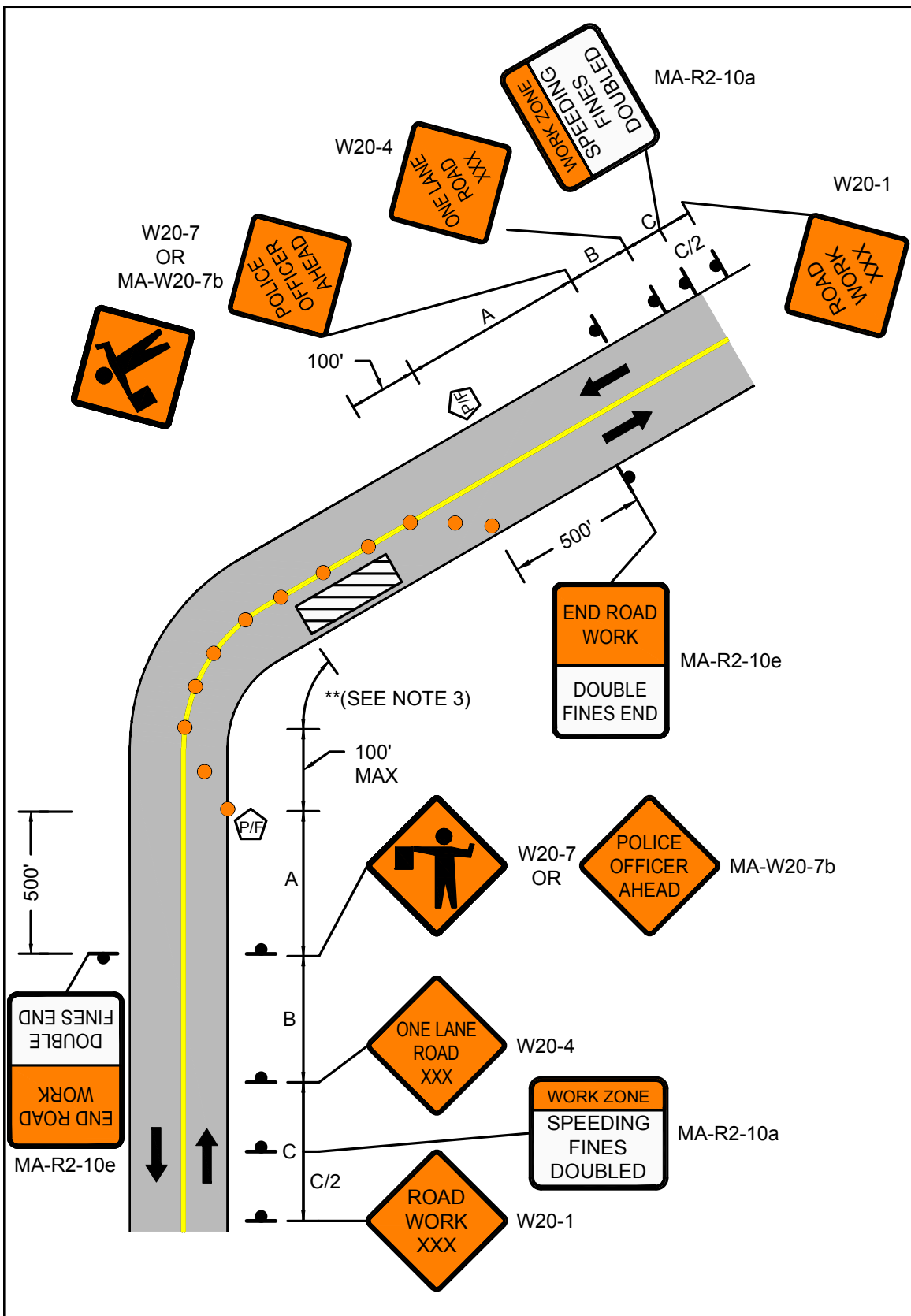

|  |   |   |
|--|---|---|
|  <p>PAGE 19</p> | <p>Work Zone Safety Standard Details and Drawings</p> | <p>FIGURE 6<br/>STATIONARY OPERATIONS<br/>TWO LANE UNDIVIDED ROADWAY<br/>HALF OF ROADWAY CLOSED<br/>WORK NEAR CURVE</p> |
|--|---|---|



PAGE 20

Work Zone Safety  
Standard Details  
and Drawings

STATIONARY OPERATIONS  
TWO LANE UNDIVIDED ROADWAY  
HALF OF ROADWAY CLOSED

| POSTED SPEED LIMIT (MPH) | SPACING FOR ADVANCE WARNING SIGNS (FT) (A,B,C) | CHANNELIZATION DEVICES (DRUMS OR CONES) |                         |                     |                   |
|--------------------------|--|---|-------------------------|---------------------|-------------------|
|                          |  | TRAVEL LANE CLOSURE LENGTH (L) (FT)     | BUFFER ZONE LENGTH (FT) | DEVICE SPACING (FT) | MIN # OF DEVICES* |
| 25-40                    | 500 / 500 / 500                                | 50                                      | 100                     | 20                  | 30                |
| 45-55                    | 500 / 1000 / 1000                              | 100                                     | 150                     | 40                  | 20                |









\* NUMBER OF DEVICES BASED ON 400 FT WORK ZONE.

| POSTED REGULATORY OR WORK ZONE SPEED | SEPARATION BETWEEN RUMBLE STRIPS |
|--------------------------------------|----------------------------------|
| 36-mph to 55-mph                     | 15-feet                          |
| 35-mph and under                     | 10-feet                          |

**NOTES**

1. IF POLICE DETAIL/UNIFORMED FLAGGER SUPPORT IS REQUIRED, PROVIDE TWO UNITS.
2. MA-R2-10a LOCATED AT C/2.
3. \*\* OPTIONAL AT THE ENGINEER'S DISCRETION.
4. \*\*\* SHALL BE DEPLOYED IF RUMBLE STRIPS ARE PRESENT.

**LEGEND**

-  WORK ZONE
-  CHANNELIZATION DEVICE
-  FLASHING ARROW BOARD
-  PORTABLE CHANGEABLE MESSAGE SIGN
-  TRUCK MOUNTED ATTENUATOR
-  RADAR SPEED FEEDBACK BOARD
-  POLICE DETAIL OR UNIFORMED FLAGGER
-  TEMPORARY PORTABLE RUMBLE STRIP
-  TYPE III BARRICADE

NOT TO SCALE

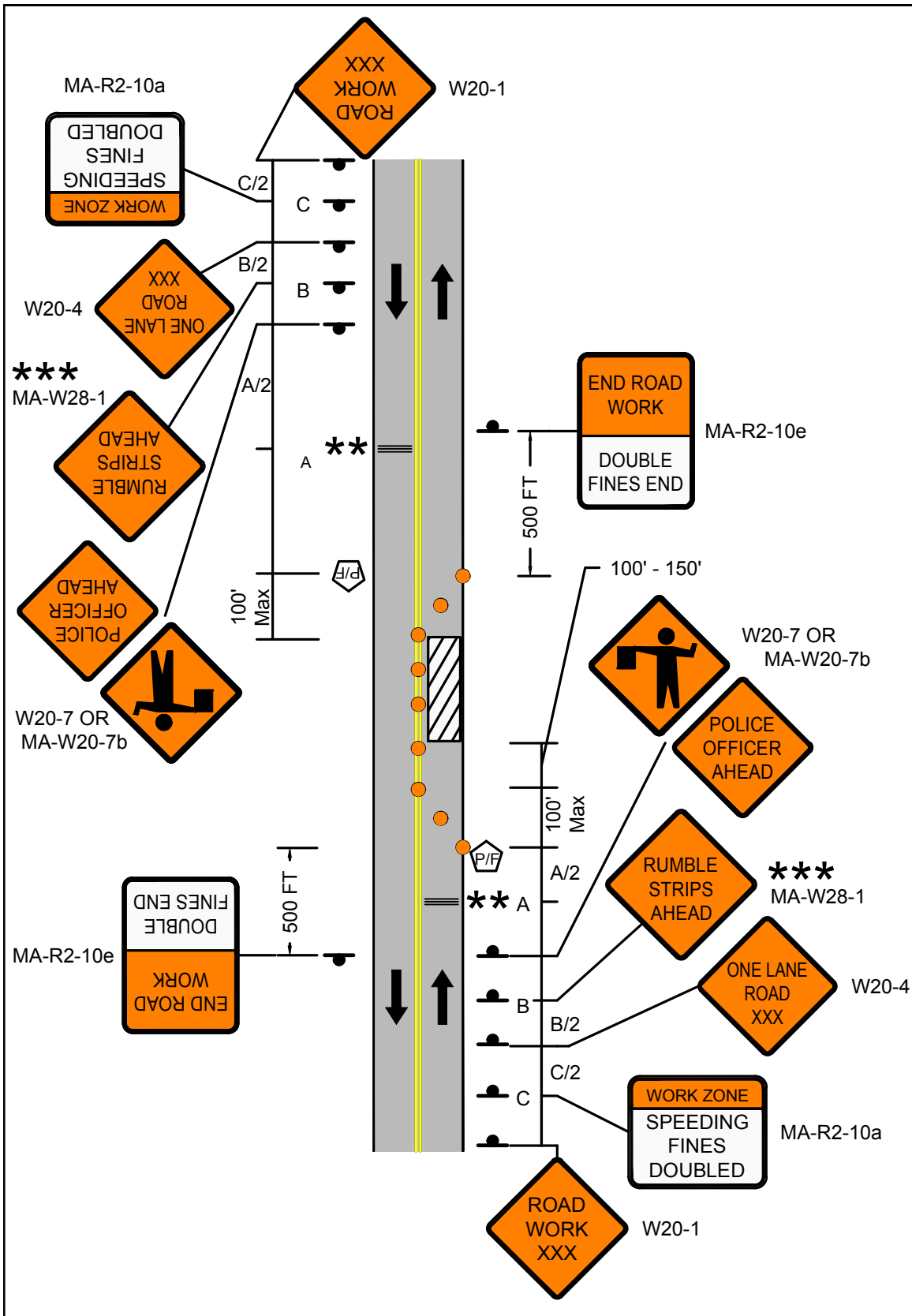

|  |   |   |
|--|---|---|
|  <p>PAGE 21</p> | <p>Work Zone Safety Standard Details and Drawings</p> | <p>FIGURE 7<br/>STATIONARY OPERATIONS<br/>TWO LANE UNDIVIDED ROADWAY<br/>HALF OF ROADWAY CLOSED</p> |
|--|---|---|



PAGE 22

Work Zone Safety  
Standard Details  
and Drawings

STATIONARY OPERATIONS  
TWO LANE UNDIVIDED ROADWAY  
SHOULDER CLOSED









| POSTED SPEED LIMIT (MPH) | SPACING FOR ADVANCE WARNING SIGNS (FT) (A,B,C) | CHANNELIZATION DEVICES (DRUMS OR CONES) |                         |                     |                   |
|--------------------------|--|---|-------------------------|---------------------|-------------------|
|                          |  | SHOULDER TAPER LENGTH (L/3) (FT)        | BUFFER ZONE LENGTH (FT) | DEVICE SPACING (FT) | MIN # OF DEVICES* |
| 25-40                    | 500 / 500 / 500                                | 110                                     | 305                     | 20                  | 45                |
| 45-55                    | 500 / 1000 / 1000                              | 220                                     | 495                     | 40                  | 30                |
| 60-65                    | 1000 / 1600 / 2600                             | 260                                     | 645                     | 40                  | 35                |

\* NUMBER OF DEVICES BASED ON 400 FT WORK ZONE.

NOTES

1. MA-R2-10a at C/2 and A/2.

LEGEND

-  WORK ZONE
-  CHANNELIZATION DEVICE
-  FLASHING ARROW BOARD
-  PORTABLE CHANGEABLE MESSAGE SIGN
-  TRUCK MOUNTED ATTENUATOR
-  RADAR SPEED FEEDBACK BOARD
-  POLICE DETAIL OR UNIFORMED FLAGGER
-  TEMPORARY PORTABLE RUMBLE STRIP
-  TYPE III BARRICADE

NOT TO SCALE

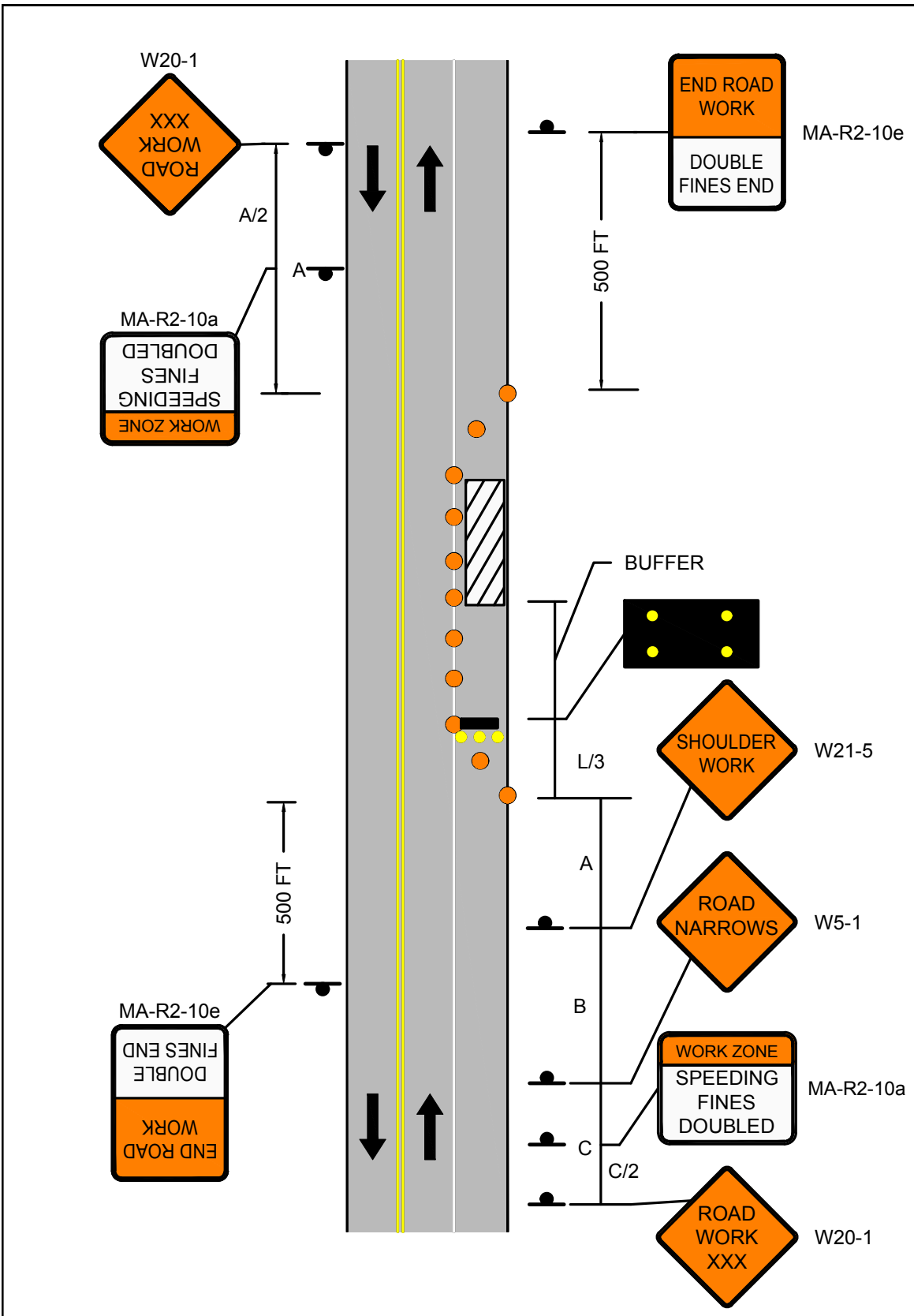

|  |   |  |
|--|---|--|
|  <p>PAGE 23</p> | <p>Work Zone Safety Standard Details and Drawings</p> | <p>FIGURE 8<br/>STATIONARY OPERATIONS<br/>TWO LANE UNDIVIDED ROADWAY<br/>SHOULDER CLOSED</p> |
|--|---|--|



PAGE 24

Work Zone Safety  
Standard Details  
and Drawings

STATIONARY OPERATIONS  
TWO LANE UNDIVIDED ROADWAY  
WITH TRAVERSABLE SHOULDER  
HALF OF ROADWAY CLOSED  
MAINTAIN TWO-WAY TRAFFIC

| POSTED SPEED LIMIT (MPH) | CHANNELIZATION DEVICES (DRUMS OR CONES) |                                     |                         |                     |                   |
|--------------------------|---|-------------------------------------|-------------------------|---------------------|-------------------|
|                          | SHOULDER TAPER LENGTH (L/3) (FT)        | TRAVEL LANE SHIFT LENGTH (L/2) (FT) | BUFFER ZONE LENGTH (FT) | DEVICE SPACING (FT) | MIN # OF DEVICES* |
| 25-40                    | 110                                     | 160                                 | 305                     | 20                  | 125               |
| 45-55                    | 220                                     | 330                                 | 495                     | 40                  | 100               |
| 60-65                    | 260                                     | 390                                 | 645                     | 40                  | 115               |









\* NUMBER OF DEVICES BASED ON 400 FT WORK ZONE.

| POSTED SPEED LIMIT (MPH) | SPACING FOR ADVANCE WARNING SIGNS (FT) (A,B,C) |
|--------------------------|--|
| 25-40                    | 500 / 500 / 500                                |
| 45-55                    | 500 / 1000 / 1000                              |
| 60-65                    | 1000 / 1600 / 2600                             |

**NOTES**

1. MA-R2-10a LOCATED AT C/2.

**LEGEND**

-  WORK ZONE
-  CHANNELIZATION DEVICE
-  FLASHING ARROW BOARD
-  PORTABLE CHANGEABLE MESSAGE SIGN
-  TRUCK MOUNTED ATTENUATOR
-  RADAR SPEED FEEDBACK BOARD
-  POLICE DETAIL OR UNIFORMED FLAGGER
-  TEMPORARY PORTABLE RUMBLE STRIP
-  TYPE III BARRICADE

NOT TO SCALE

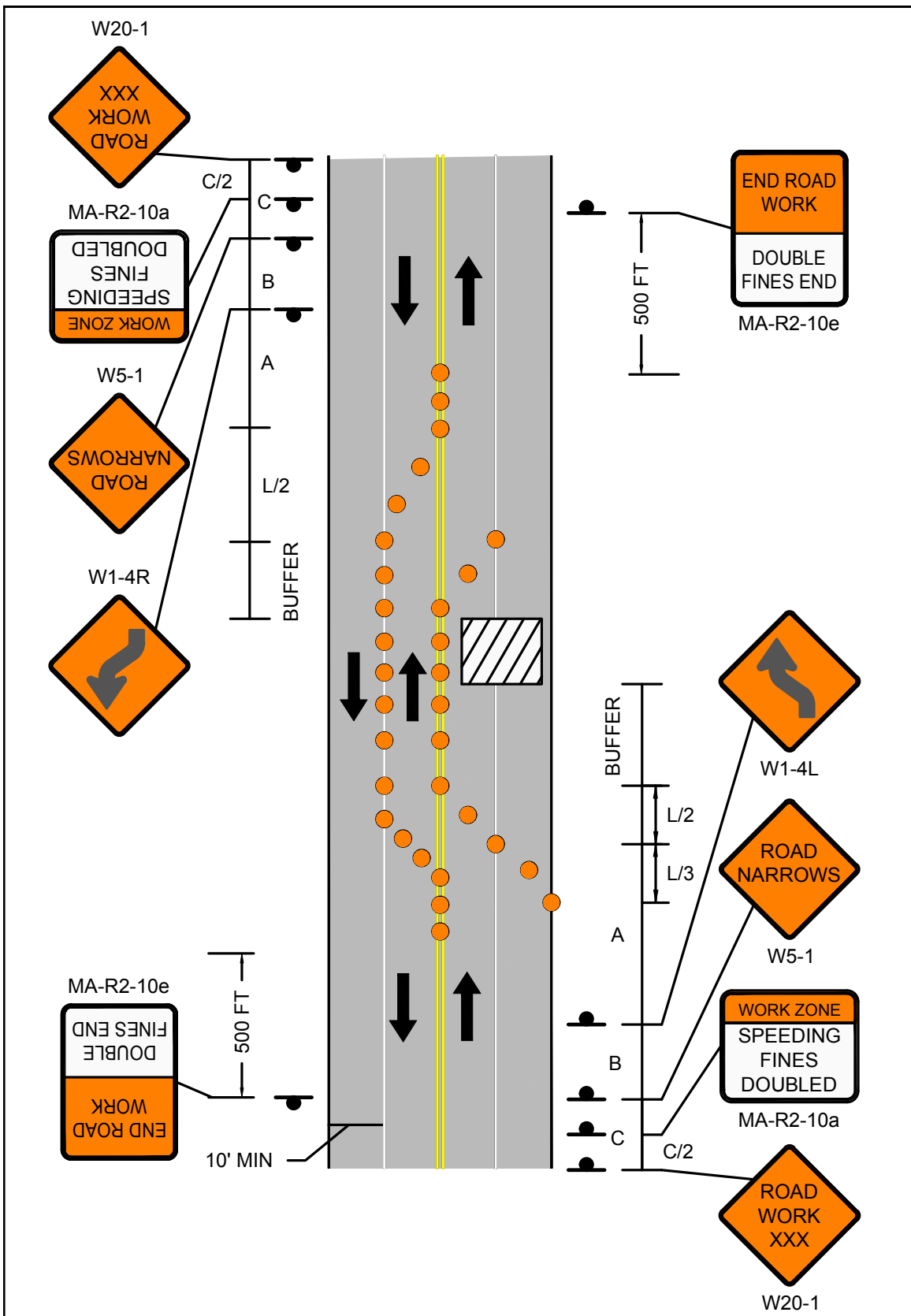

FIGURE 9  
 STATIONARY OPERATIONS  
 TWO LANE UNDIVIDED ROADWAY  
 WITH TRAVERSABLE SHOULDER  
 HALF OF ROADWAY CLOSED  
 MAINTAIN TWO-WAY TRAFFIC



Work Zone Safety  
 Standard Details  
 and Drawings



PAGE 26

Work Zone Safety  
Standard Details  
and Drawings

STATIONARY OPERATIONS  
FOUR LANE UNDIVIDED ROADWAY  
RIGHT LANE CLOSED

| POSTED SPEED LIMIT (MPH) | CHANNELATION DEVICES (DRUMS OR CONES) |                                     |                         |                     |                   |
|--------------------------|---------------------------------------|-------------------------------------|-------------------------|---------------------|-------------------|
|                          | SHOULDER TAPER LENGTH (L/3) (FT)      | TRAVEL LANE CLOSURE LENGTH (L) (FT) | BUFFER ZONE LENGTH (FT) | DEVICE SPACING (FT) | MIN # OF DEVICES* |
| 25-40                    | 110                                   | 320                                 | 305                     | 20                  | 60                |
| 45-55                    | 220                                   | 660                                 | 495                     | 40                  | 50                |
| 60-65                    | 260                                   | 780                                 | 645                     | 40                  | 55                |









\* NUMBER OF DEVICES BASED ON 400 FT WORK ZONE.

| POSTED SPEED LIMIT (MPH) | SPACING FOR ADVANCE WARNING SIGNS (FT) (A,B,C) |
|--------------------------|--|
| 25-40                    | 500 / 500 / 500                                |
| 45-55                    | 500 / 1000 / 1000                              |
| 60-65                    | 1000 / 1600 / 2600                             |

**NOTES**

1. MA-R2-10a LOCATED AT A/2 AND C/2.
2. \*\*OPTIONAL AT THE ENGINEER'S DISCRETION.

**LEGEND**

-  WORK ZONE
-  CHANNELIZATION DEVICE
-  FLASHING ARROW BOARD
-  PORTABLE CHANGEABLE MESSAGE SIGN
-  TRUCK MOUNTED ATTENUATOR
-  RADAR SPEED FEEDBACK BOARD
-  POLICE DETAIL OR UNIFORMED FLAGGER
-  TEMPORARY PORTABLE RUMBLE STRIP
-  TYPE III BARRICADE

NOT TO SCALE



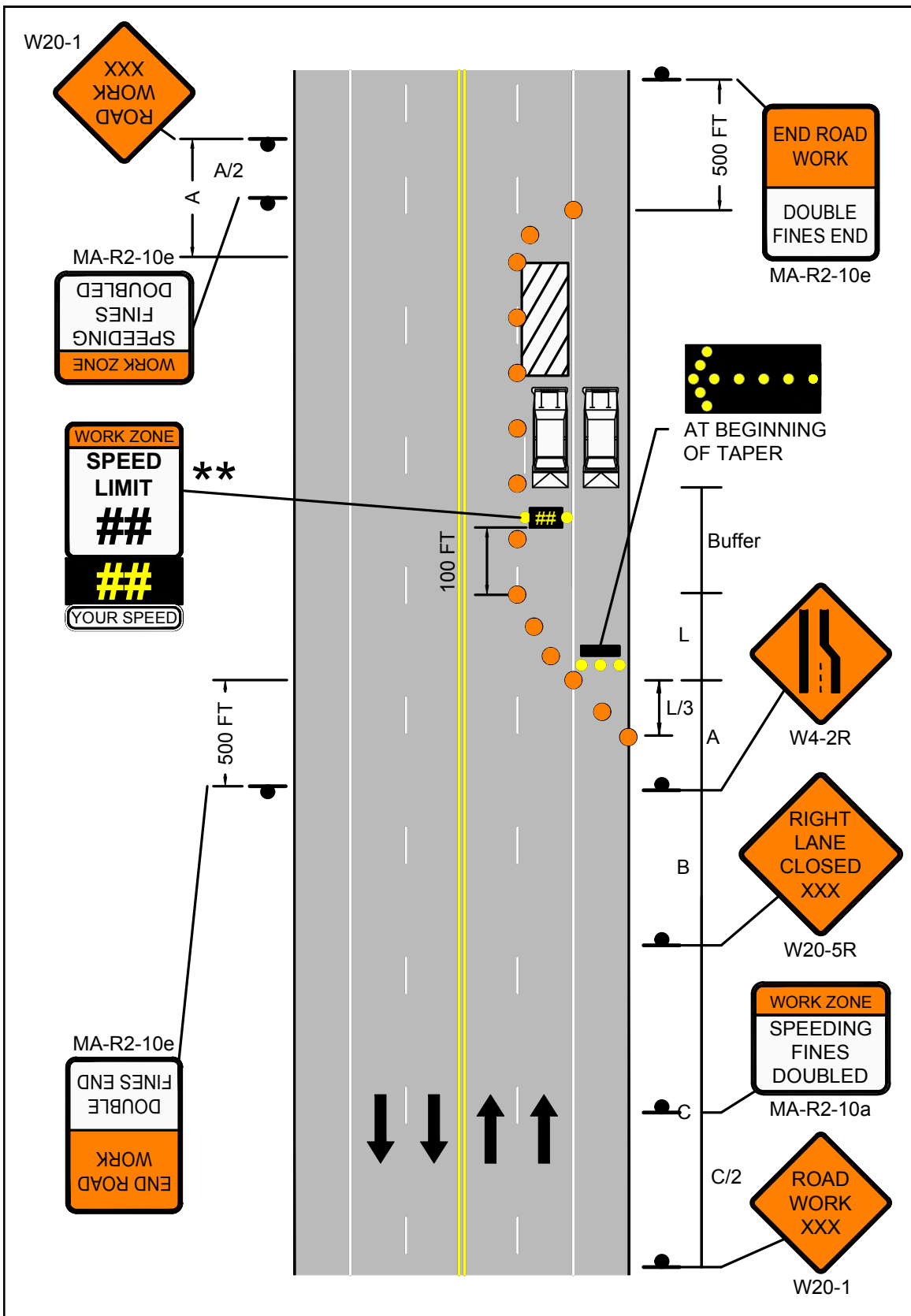

|  |   |  |
|--|---|--|
|  <p>PAGE 27</p> | <p>Work Zone Safety Standard Details and Drawings</p> | <p>FIGURE 10<br/>STATIONARY OPERATIONS<br/>FOUR LANE UNDIVIDED ROADWAY<br/>RIGHT LANE CLOSED</p> |
|--|---|--|



PAGE 28

Work Zone Safety  
Standard Details  
and Drawings

STATIONARY OPERATIONS  
FOUR LANE UNDIVIDED ROADWAY  
LEFT LANE CLOSED









| POSTED SPEED LIMIT (MPH) | SPACING FOR ADVANCE WARNING SIGNS (FT) (A,B,C) | CHANNELIZATION DEVICES (DRUMS OR CONES) |                         |                     |                   |
|--------------------------|--|---|-------------------------|---------------------|-------------------|
|                          |  | TRAVEL LANE CLOSURE LENGTH (L) (FT)     | BUFFER ZONE LENGTH (FT) | DEVICE SPACING (FT) | MIN # OF DEVICES* |
| 25-40                    | 500 / 500 / 500                                | 320                                     | 305                     | 20                  | 105               |
| 45-55                    | 500 / 1000 / 1000                              | 660                                     | 495                     | 40                  | 80                |
| 60-65                    | 1000 / 1600 / 2600                             | 780                                     | 645                     | 40                  | 100               |

\* NUMBER OF DEVICES BASED ON 400 FT WORK ZONE.

**NOTES**

1. MA-R2-10a LOCATED AT A/2 AND C/2.
2. \*\*OPTIONAL AT THE ENGINEER'S DISCRETION. 2' OFFSET FROM EDGE OF TRAVEL LANE TO RADAR SPEED FEEDBACK BOARD IS REQUIRED. BOARD MAY BE MOVED FULLY OR PARTIALLY OFF PAVED SHOULDER, IF REQUIRED.

**LEGEND**

-  WORK ZONE
-  CHANNELIZATION DEVICE
-  FLASHING ARROW BOARD
-  PORTABLE CHANGEABLE MESSAGE SIGN
-  TRUCK MOUNTED ATTENUATOR
-  RADAR SPEED FEEDBACK BOARD
-  POLICE DETAIL OR UNIFORMED FLAGGER
-  TEMPORARY PORTABLE RUMBLE STRIP
-  TYPE III BARRICADE

NOT TO SCALE

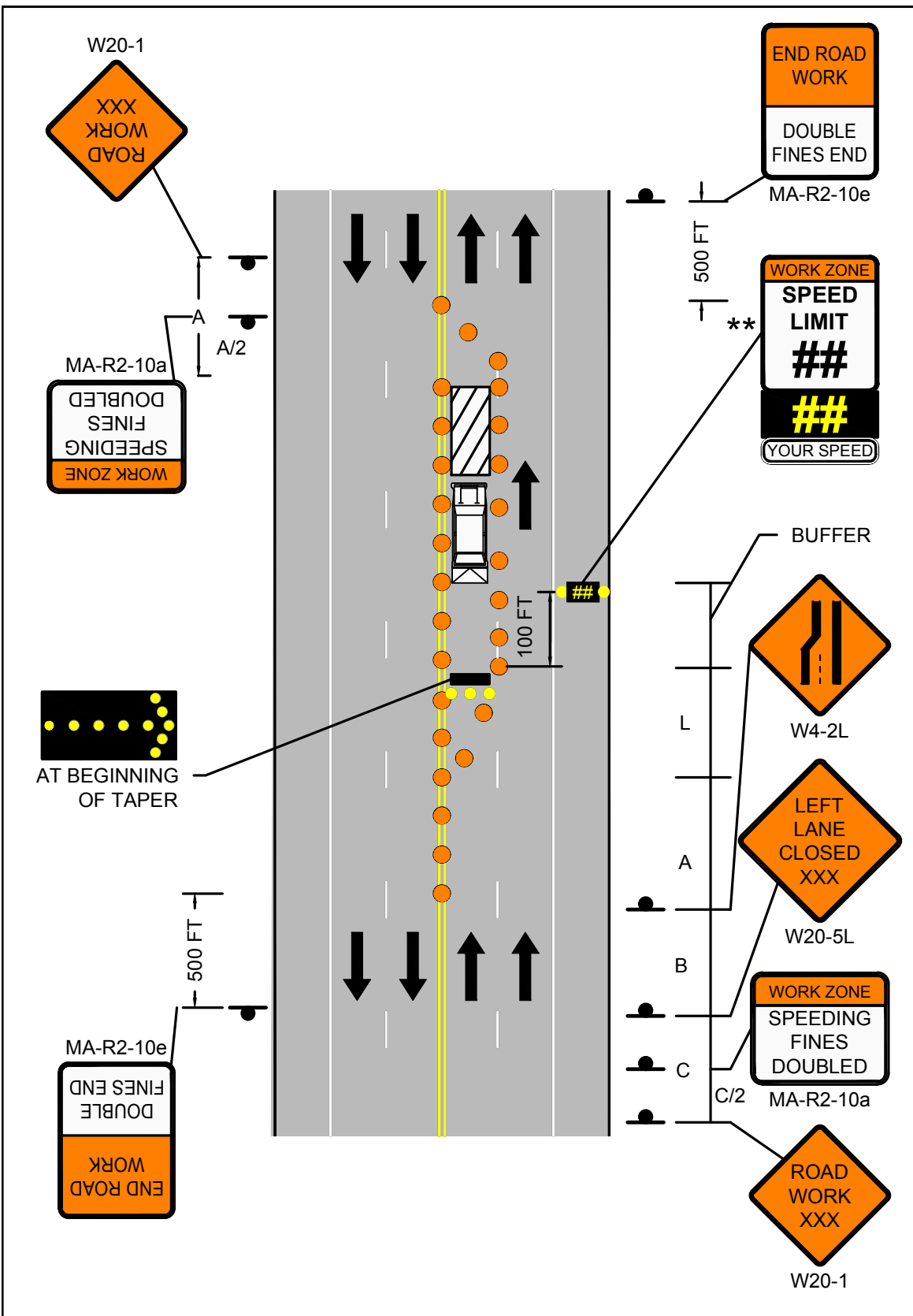

|   |   |   |
|---|---|---|
|  <p>Massachusetts Department of Transportation<br/>Highway Division</p> <p>PAGE 30</p> | <p>Work Zone Safety<br/>Standard Details<br/>and Drawings</p> | <p>STATIONARY OPERATIONS<br/>FOUR LANE UNDIVIDED ROADWAY<br/>HALF OF ROADWAY CLOSED</p> |
|---|---|---|

| POSTED SPEED LIMIT (MPH) | CHANNELIZATION DEVICES (DRUMS OR CONES) |                                     |                                     |                         |                     |                   |
|--------------------------|---|-------------------------------------|-------------------------------------|-------------------------|---------------------|-------------------|
|                          | SHOULDER TAPER LENGTH (L/3) (FT)        | TRAVEL LANE CLOSURE LENGTH (L) (FT) | TRAVEL LANE SHIFT LENGTH (L/2) (FT) | BUFFER ZONE LENGTH (FT) | DEVICE SPACING (FT) | MIN # OF DEVICES* |
| 25-40                    | 110                                     | 320                                 | 160                                 | 305                     | 20                  | 140               |
| 45-55                    | 220                                     | 660                                 | 330                                 | 495                     | 40                  | 120               |
| 60-65                    | 260                                     | 780                                 | 390                                 | 645                     | 40                  | 140               |









\* NUMBER OF DEVICES BASED ON 400 FT WORK ZONE.

| POSTED SPEED LIMIT (MPH) | SPACING FOR ADVANCE WARNING SIGNS (FT) (A,B,C) |
|--------------------------|--|
| 25-40                    | 500 / 500 / 500                                |
| 45-55                    | 500 / 1000 / 1000                              |
| 60-65                    | 1000 / 1600 / 2600                             |

**NOTES**

1. MA-R2-10a LOCATED AT C/2.
2. \*\*OPTIONAL AT THE ENGINEER'S DISCRETION.
3. W1-4L SHALL BE PLACED AT THE MIDDLE OF THE TANGENT.

**LEGEND**

-  WORK ZONE
-  CHANNELIZATION DEVICE
-  FLASHING ARROW BOARD
-  PORTABLE CHANGEABLE MESSAGE SIGN
-  TRUCK MOUNTED ATTENUATOR
-  RADAR SPEED FEEDBACK BOARD
-  POLICE DETAIL OR UNIFORMED FLAGGER
-  TEMPORARY PORTABLE RUMBLE STRIP
-  TYPE III BARRICADE

NOT TO SCALE

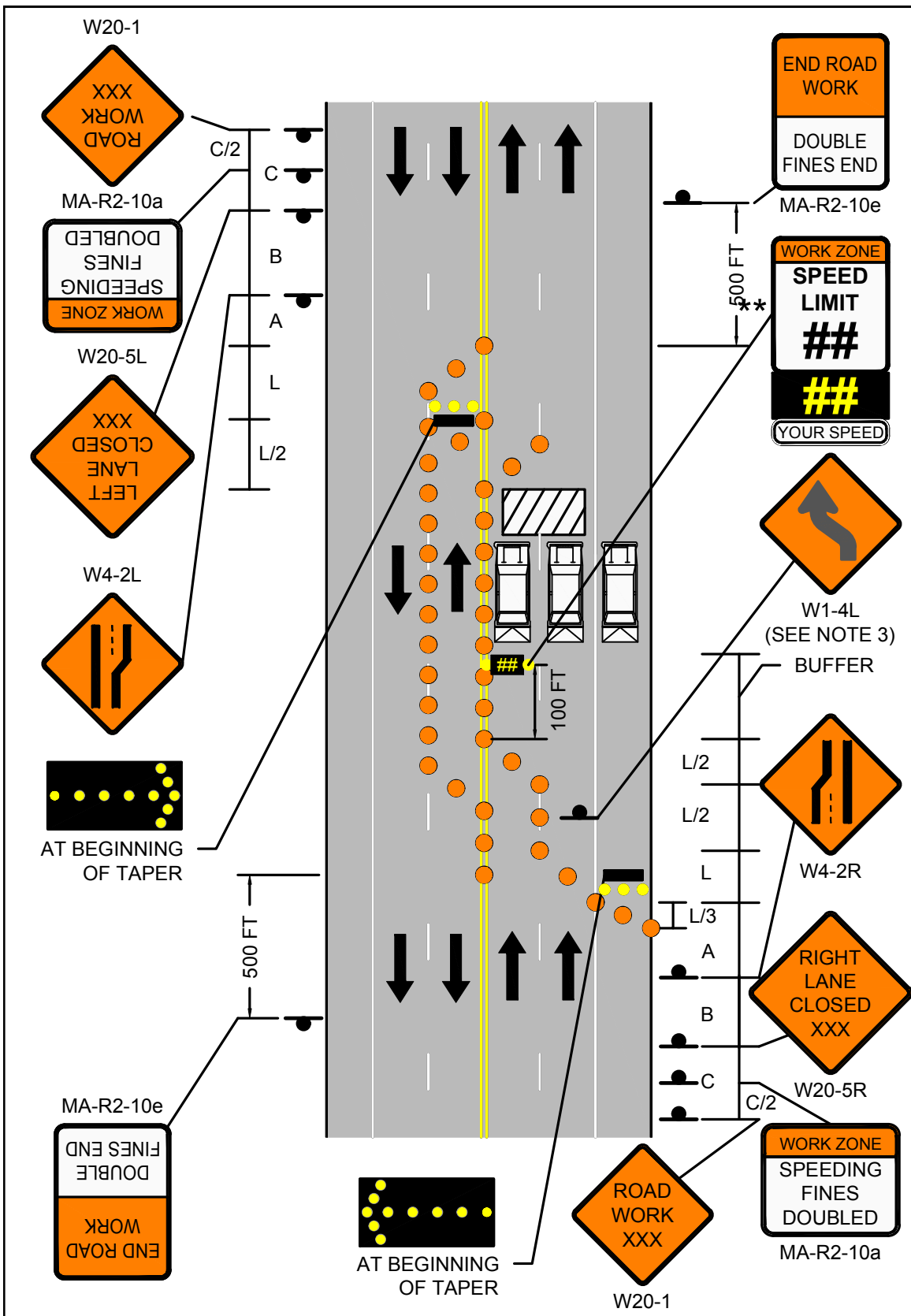

|  |   |   |
|--|---|---|
|  <p>PAGE 31</p> | <p>Work Zone Safety Standard Details and Drawings</p> | <p>FIGURE 12<br/>STATIONARY OPERATIONS<br/>FOUR LANE UNDIVIDED ROADWAY<br/>HALF OF ROADWAY CLOSED</p> |
|--|---|---|



PAGE 32

Work Zone Safety  
Standard Details  
and Drawings

STATIONARY OPERATIONS  
MULTILANE DIVIDED ROADWAY  
RIGHT LANE CLOSED

| POSTED SPEED LIMIT (MPH) | CHANNELIZATION DEVICES (DRUMS OR CONES) |                                     |                         |                     |                   |
|--------------------------|---|-------------------------------------|-------------------------|---------------------|-------------------|
|                          | SHOULDER TAPER LENGTH (L/3) (FT)        | TRAVEL LANE CLOSURE LENGTH (L) (FT) | BUFFER ZONE LENGTH (FT) | DEVICE SPACING (FT) | MIN # OF DEVICES* |
| 25-40                    | 110                                     | 320                                 | 305                     | 20                  | 60                |
| 45-55                    | 220                                     | 660                                 | 495                     | 40                  | 50                |
| 60-65                    | 260                                     | 780                                 | 645                     | 40                  | 55                |









\* NUMBER OF DEVICES BASED ON 400 FT WORK ZONE.

| POSTED SPEED LIMIT (MPH) | SPACING FOR ADVANCE WARNING SIGNS (FT) (A,B,C) |
|--------------------------|--|
| 25-40                    | 500 / 500 / 500                                |
| 45-55                    | 500 / 1000 / 1000                              |
| 60-65                    | 1000 / 1600 / 2600                             |

**NOTES**

1. MA-R2-10a LOCATED AT C/2.
2. \*\*OPTIONAL AT THE ENGINEER'S DISCRETION.

**LEGEND**

-  WORK ZONE
-  CHANNELIZATION DEVICE
-  FLASHING ARROW BOARD
-  PORTABLE CHANGEABLE MESSAGE SIGN
-  TRUCK MOUNTED ATTENUATOR
-  RADAR SPEED FEEDBACK BOARD
-  POLICE DETAIL OR UNIFORMED FLAGGER
-  TEMPORARY PORTABLE RUMBLE STRIP
-  TYPE III BARRICADE

NOT TO SCALE

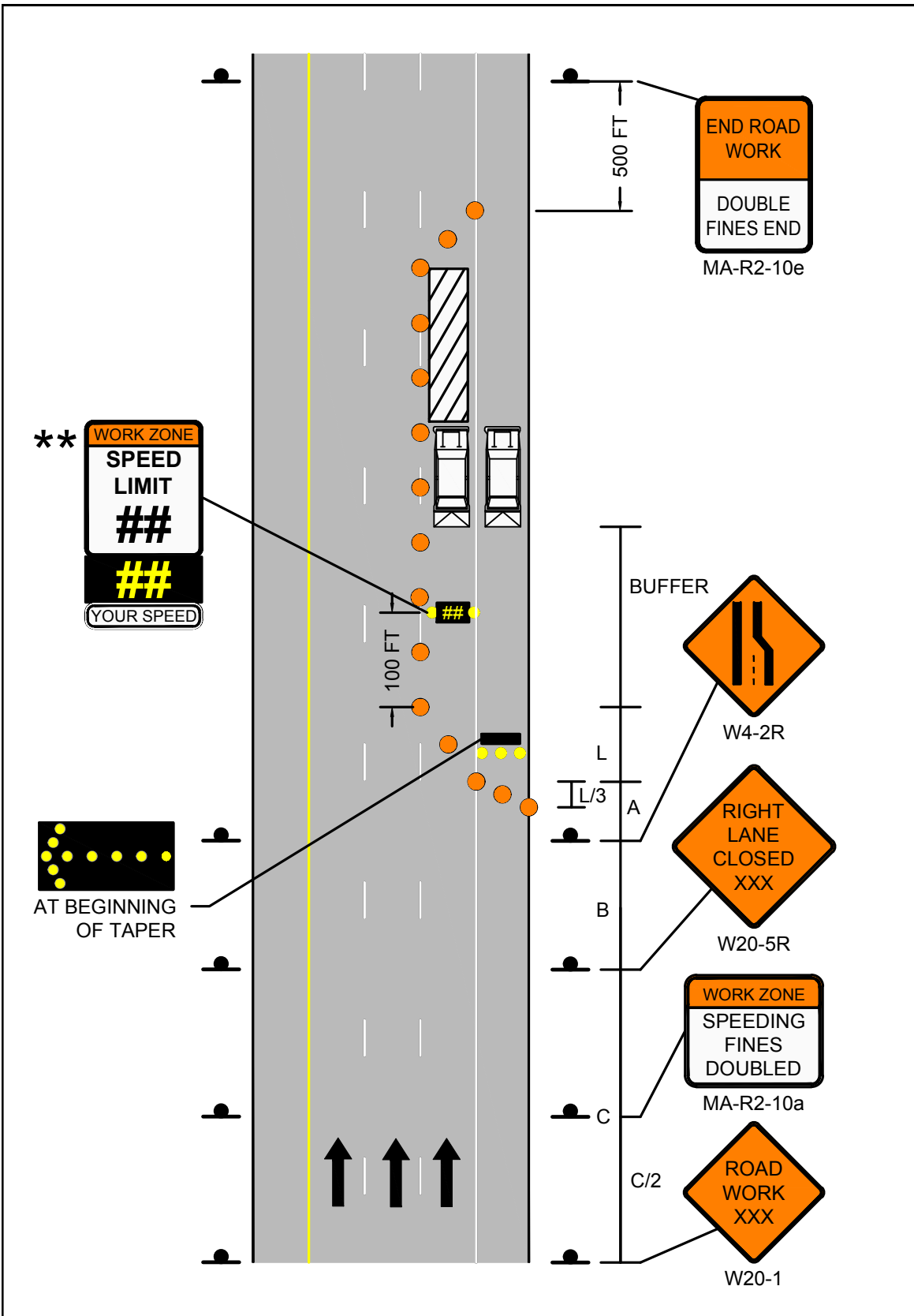



PAGE 34

Work Zone Safety  
Standard Details  
and Drawings

STATIONARY OPERATIONS  
MULTILANE DIVIDED ROADWAY  
LEFT LANE CLOSED

| POSTED SPEED LIMIT (MPH) | CHANNELIZATION DEVICES (DRUMS OR CONES) |                                     |                         |                     |                   |
|--------------------------|---|-------------------------------------|-------------------------|---------------------|-------------------|
|                          | SHOULDER TAPER LENGTH (L/3) (FT)        | TRAVEL LANE CLOSURE LENGTH (L) (FT) | BUFFER ZONE LENGTH (FT) | DEVICE SPACING (FT) | MIN # OF DEVICES* |
| 25-40                    | 110                                     | 320                                 | 305                     | 20                  | 60                |
| 45-55                    | 220                                     | 660                                 | 495                     | 40                  | 50                |
| 60-65                    | 260                                     | 780                                 | 645                     | 40                  | 55                |









\* NUMBER OF DEVICES BASED ON 400 FT WORK ZONE.

| POSTED SPEED LIMIT (MPH) | SPACING FOR ADVANCE WARNING SIGNS (FT) (A,B,C) |
|--------------------------|--|
| 25-40                    | 500 / 500 / 500                                |
| 45-55                    | 500 / 1000 / 1000                              |
| 60-65                    | 1000 / 1600 / 2600                             |

**NOTES**

1. MA-R2-10a LOCATED AT C/2.
2. \*\*OPTIONAL AT THE ENGINEER'S DISCRETION.

**LEGEND**

-  WORK ZONE
-  CHANNELIZATION DEVICE
-  FLASHING ARROW BOARD
-  PORTABLE CHANGEABLE MESSAGE SIGN
-  TRUCK MOUNTED ATTENUATOR
-  RADAR SPEED FEEDBACK BOARD
-  POLICE DETAIL OR UNIFORMED FLAGGER
-  TEMPORARY PORTABLE RUMBLE STRIP
-  TYPE III BARRICADE

NOT TO SCALE



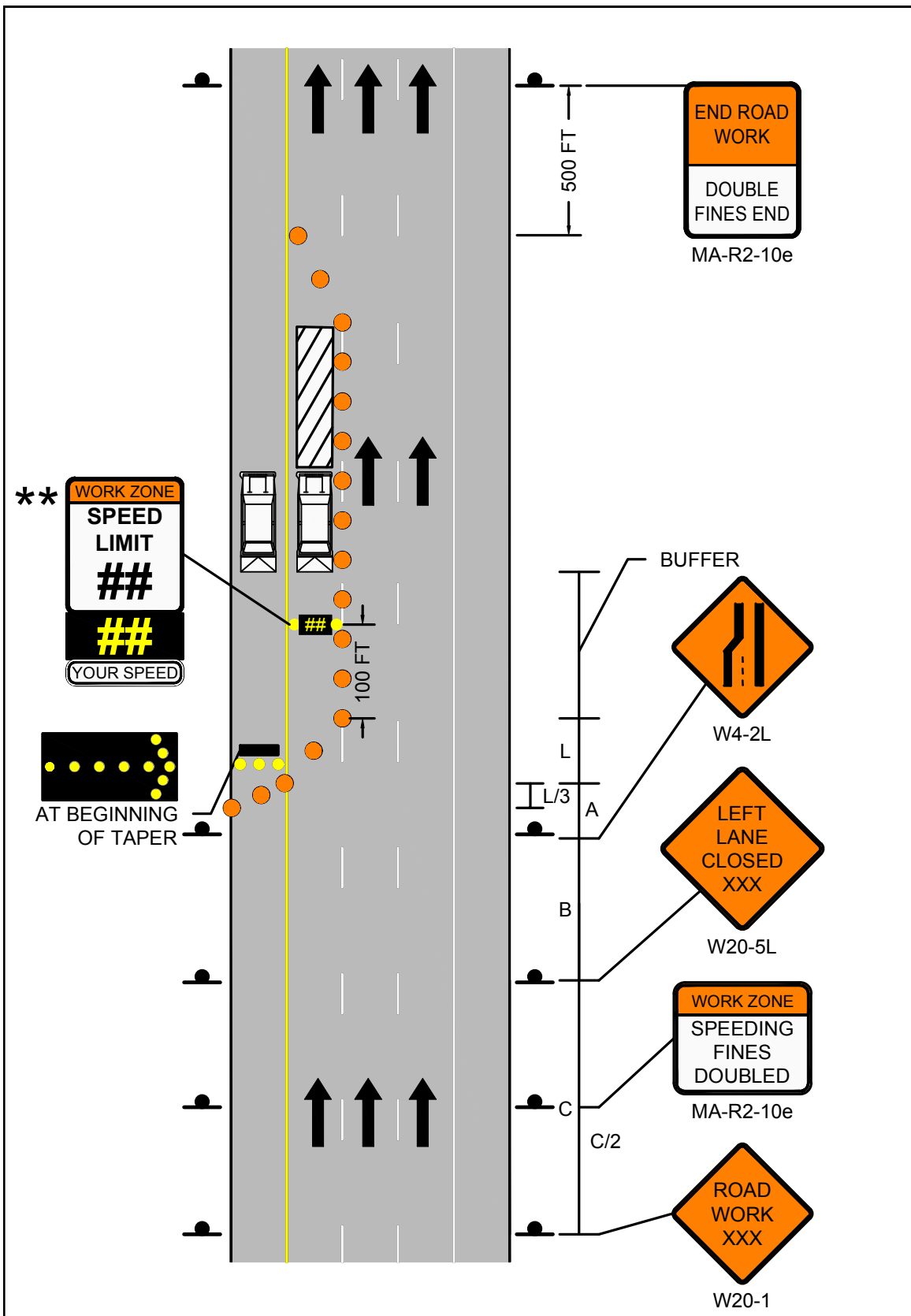

|   |  |   |
|---|--|---|
|  <p>Massachusetts Department of Transportation<br/>Highway Division</p> <p>PAGE 36</p> | Work Zone Safety<br>Standard Details<br>and Drawings | STATIONARY OPERATIONS<br>MULTILANE DIVIDED ROADWAY<br>CENTER LANE OR RIGHT/CENTER<br>LANES CLOSED |
|---|--|---|

| POSTED SPEED LIMIT (MPH) | CHANNELIZATION DEVICES (DRUMS OR CONES) |                                     |                                      |                         |                     |                   |
|--------------------------|---|-------------------------------------|--------------------------------------|-------------------------|---------------------|-------------------|
|                          | SHOULDER TAPER LENGTH (L/3) (FT)        | TRAVEL LANE CLOSURE LENGTH (L) (FT) | TANGENT LENGTH BETWEEN TAPERS T (FT) | BUFFER ZONE LENGTH (FT) | DEVICE SPACING (FT) | MIN # OF DEVICES* |
| 25-40                    | 110                                     | 320                                 | 640                                  | 305                     | 20                  | 110               |
| 45-55                    | 220                                     | 660                                 | 1320                                 | 495                     | 40                  | 100               |
| 60-65                    | 260                                     | 780                                 | 1560                                 | 645                     | 40                  | 115               |









\* NUMBER OF DEVICES BASED ON 400 FT WORK ZONE.

| POSTED SPEED LIMIT (MPH) | SPACING FOR ADVANCE WARNING SIGNS (FT) (A,B,C) |
|--------------------------|--|
| 25-40                    | 500 / 500 / 500                                |
| 45-55                    | 500 / 1000 / 1000                              |
| 60-65                    | 1000 / 1600 / 2600                             |

**NOTES**

1. MA-R2-10a LOCATED AT C/2.
2. \*\*\*OPTIONAL AT THE ENGINEER'S DISCRETION.
3. \*\*\*THIS SET OF SIGNS SHALL BE LOCATED AT T/2.

**LEGEND**

-  WORK ZONE
-  CHANNELIZATION DEVICE
-  FLASHING ARROW BOARD
-  PORTABLE CHANGEABLE MESSAGE SIGN
-  TRUCK MOUNTED ATTENUATOR
-  RADAR SPEED FEEDBACK BOARD
-  POLICE DETAIL OR UNIFORMED FLAGGER
-  TEMPORARY PORTABLE RUMBLE STRIP
-  TYPE III BARRICADE

NOT TO SCALE

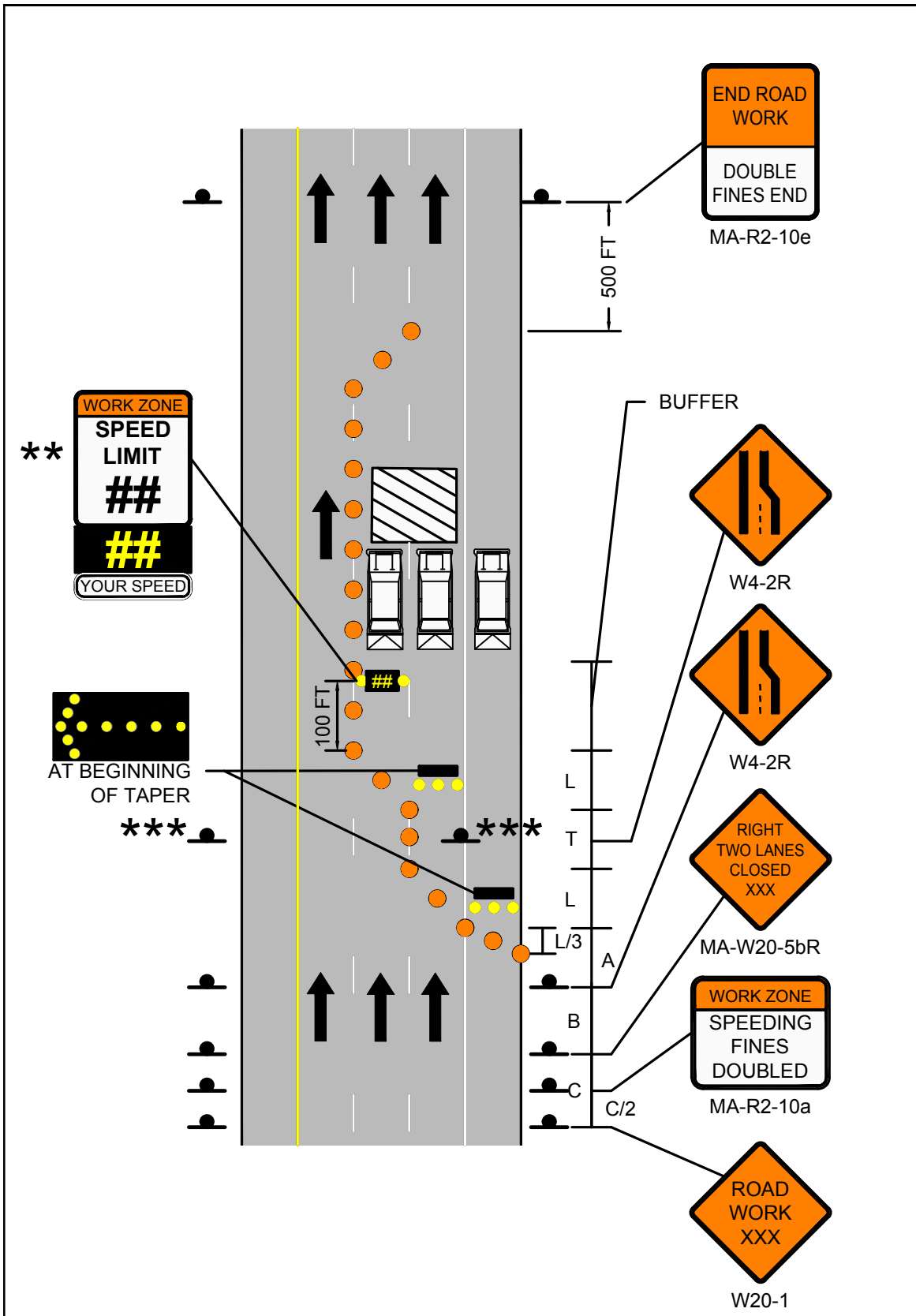

**FIGURE 15**  
**STATIONARY OPERATIONS**  
**MULTILANE DIVIDED ROADWAY**  
**CENTER LANE OR RIGHT/CENTER**  
**LANES CLOSED**



|   |  |  |
|---|--|--|
|  <p>Massachusetts Department of Transportation<br/>Highway Division</p> <p>PAGE 38</p> | Work Zone Safety<br>Standard Details<br>and Drawings | STATIONARY OPERATIONS<br>MULTILANE DIVIDED ROADWAY<br>CENTER LANE OR LEFT/CENTER LANES<br>CLOSED |
|---|--|--|

| POSTED<br>SPEED<br>LIMIT<br>(MPH) | CHANNELIZATION DEVICES (DRUMS OR CONES)   |   |  |                                  |                           |                         |
|-----------------------------------|---|---|--|----------------------------------|---------------------------|-------------------------|
|                                   | SHOULDER<br>TAPER<br>LENGTH<br>(L/3) (FT) | TRAVEL<br>LANE<br>CLOSURE<br>LENGTH<br>(L) (FT) | TANGENT<br>LENGTH<br>BETWEEN<br>TAPERS<br>T (FT) | BUFFER<br>ZONE<br>LENGTH<br>(FT) | DEVICE<br>SPACING<br>(FT) | MIN<br># OF<br>DEVICES* |
| 25-40                             | 110                                       | 320   | 640  | 305                              | 20                        | 110                     |
| 45-55                             | 220                                       | 660   | 1320   | 495                              | 40                        | 100                     |
| 60-65                             | 260                                       | 780   | 1560   | 645                              | 40                        | 115                     |









\* NUMBER OF DEVICES BASED ON 400 FT WORK ZONE.

| POSTED<br>SPEED<br>LIMIT<br>(MPH) | SPACING FOR<br>ADVANCE WARNING<br>SIGNS (FT)<br>(A,B,C) |
|-----------------------------------|---|
| 25-40                             | 500 / 500 / 500   |
| 45-55                             | 500 / 1000 / 1000                                       |
| 60-65                             | 1000 / 1600 / 2600                                      |

**NOTES**

1. MA-R2-10a LOCATED AT C/2.
2. \*\*\*OPTIONAL AT THE ENGINEER'S DISCRETION.
3. \*\*\*THIS SET OF SIGNS SHALL BE LOCATED AT T/2.

**LEGEND**

-  WORK ZONE
-  CHANNELIZATION DEVICE
-  FLASHING ARROW BOARD
-  PORTABLE CHANGEABLE MESSAGE SIGN
-  TRUCK MOUNTED ATTENUATOR
-  RADAR SPEED FEEDBACK BOARD
-  POLICE DETAIL OR UNIFORMED FLAGGER
-  TEMPORARY PORTABLE RUMBLE STRIP
-  TYPE III BARRICADE

NOT TO SCALE

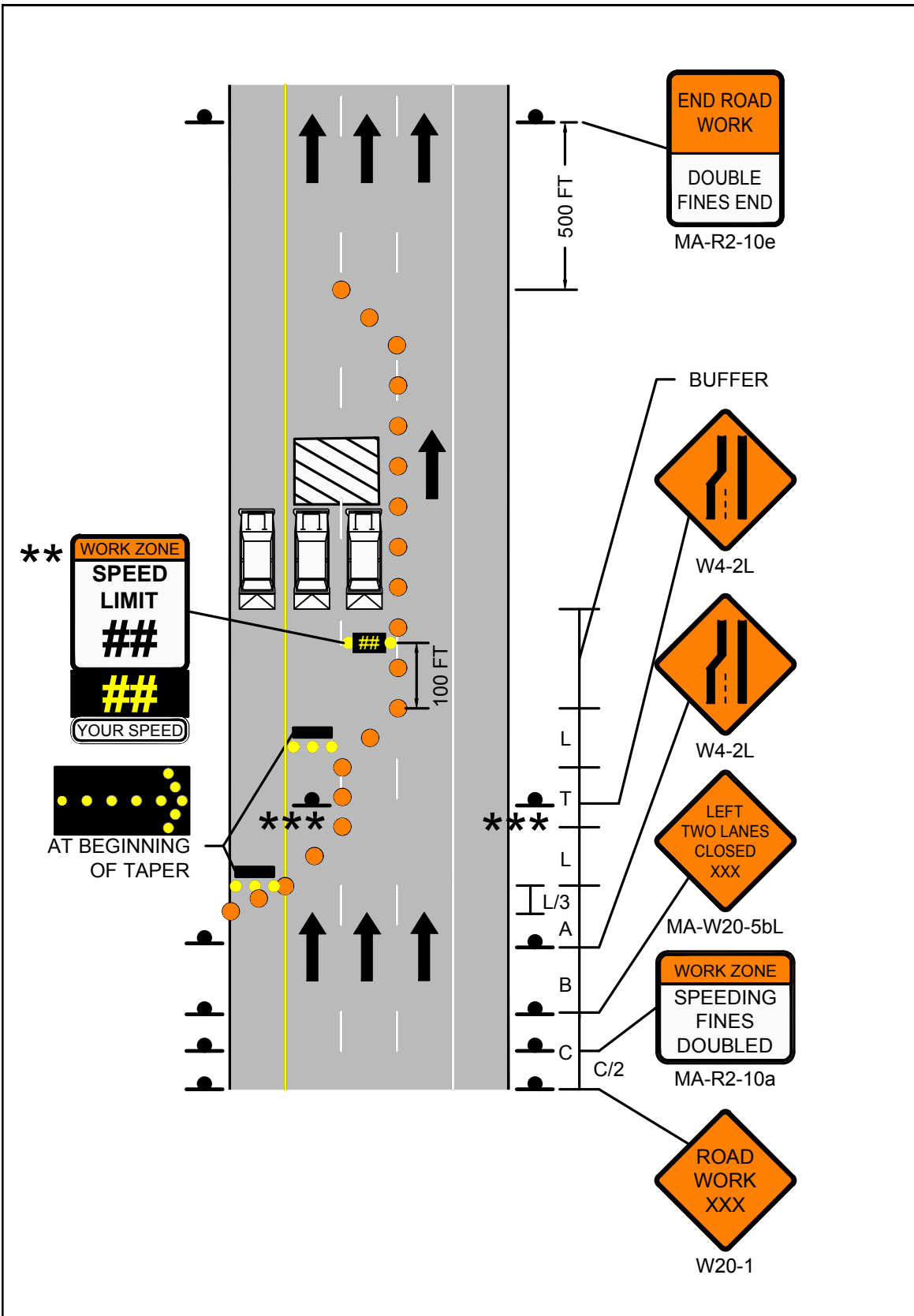

|   |   |  |
|---|---|--|
|  <p>Massachusetts Department of Transportation<br/>Highway Division</p> <p>PAGE 39</p> | <p>Work Zone Safety<br/>Standard Details<br/>and Drawings</p> | <p>FIGURE 16<br/>STATIONARY OPERATIONS<br/>MULTILANE DIVIDED ROADWAY<br/>CENTER LANE OR LEFT/CENTER LANES<br/>CLOSED</p> |
|---|---|--|



PAGE 40

Work Zone Safety  
Standard Details  
and Drawings

STATIONARY OPERATIONS  
MULTILANE DIVIDED ROADWAY  
RIGHT SIDE OF OFF RAMP CLOSED









| POSTED<br>SPEED<br>LIMIT<br>(MPH) | SPACING FOR<br>ADVANCE WARNING<br>SIGNS (FT)<br>(A,B,C) | CHANNELIZATION DEVICES (DRUMS OR CONES)         |                                  |                           |                         |
|-----------------------------------|---|---|----------------------------------|---------------------------|-------------------------|
|                                   |   | TRAVEL<br>LANE<br>SHIFT<br>LENGTH<br>(L/2) (FT) | BUFFER<br>ZONE<br>LENGTH<br>(FT) | DEVICE<br>SPACING<br>(FT) | MIN<br># OF<br>DEVICES* |
| 25-40                             | 500 / 500 / 500   | 160   | 305                              | 20                        | 45                      |
| 45-55                             | 500 / 1000 / 1000                                       | 330   | 495                              | 40                        | 35                      |

\* NUMBER OF DEVICES BASED ON 400 FT WORK ZONE.

NOTES

1. MA-R2-10a LOCATED AT C/2.

LEGEND

-  WORK ZONE
-  CHANNELIZATION DEVICE
-  FLASHING ARROW BOARD
-  PORTABLE CHANGEABLE MESSAGE SIGN
-  TRUCK MOUNTED ATTENUATOR
-  RADAR SPEED FEEDBACK BOARD
-  POLICE DETAIL OR UNIFORMED FLAGGER
-  TEMPORARY PORTABLE RUMBLE STRIP
-  TYPE III BARRICADE

NOT TO SCALE

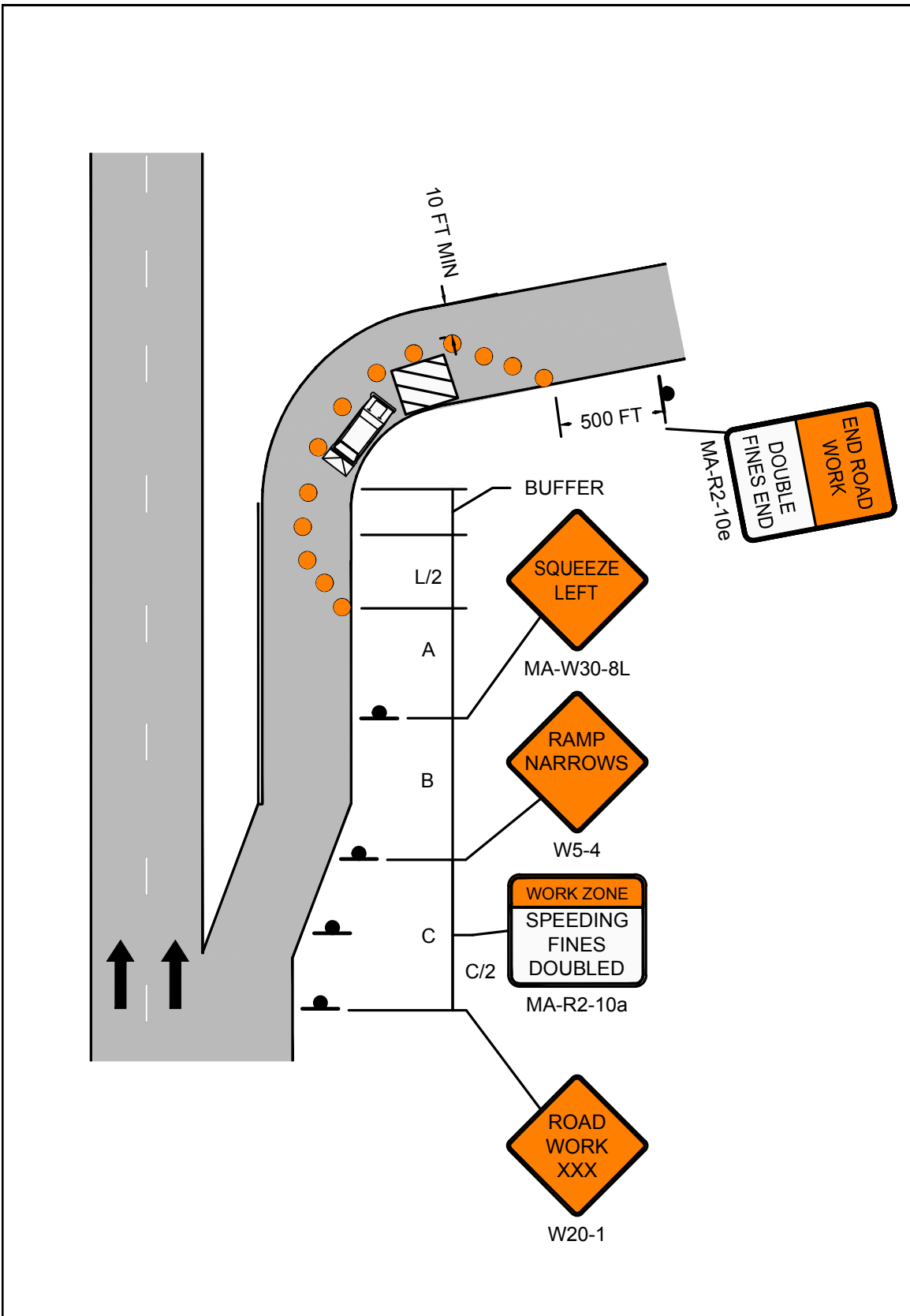

|  |   |  |
|--|---|--|
|  <p>PAGE 41</p> | <p>Work Zone Safety<br/>Standard Details<br/>and Drawings</p> | <p>FIGURE 17<br/>STATIONARY OPERATIONS<br/>MULTILANE DIVIDED ROADWAY<br/>RIGHT SIDE OF OFF RAMP CLOSED</p> |
|--|---|--|



PAGE 42

Work Zone Safety  
Standard Details  
and Drawings

STATIONARY OPERATIONS  
MULTILANE DIVIDED ROADWAY  
LEFT SIDE OF OFF RAMP CLOSED









| POSTED SPEED LIMIT (MPH) | SPACING FOR ADVANCE WARNING SIGNS (FT) (A,B,C) | CHANNELIZATION DEVICES (DRUMS OR CONES) |                         |                     |                   |
|--------------------------|--|---|-------------------------|---------------------|-------------------|
|                          |  | TRAVEL LANE SHIFT LENGTH (L/2) (FT)     | BUFFER ZONE LENGTH (FT) | DEVICE SPACING (FT) | MIN # OF DEVICES* |
| 25-40                    | 500 / 500 / 500                                | 160                                     | 305                     | 20                  | 45                |
| 45-55                    | 500 / 1000 / 1000                              | 330                                     | 495                     | 40                  | 35                |

\* NUMBER OF DEVICES BASED ON 400 FT WORK ZONE.

NOTES

1. MA-R2-10a LOCATED AT C/2.

LEGEND

-  WORK ZONE
-  CHANNELIZATION DEVICE
-  FLASHING ARROW BOARD
-  PORTABLE CHANGEABLE MESSAGE SIGN
-  TRUCK MOUNTED ATTENUATOR
-  RADAR SPEED FEEDBACK BOARD
-  POLICE DETAIL OR UNIFORMED FLAGGER
-  TEMPORARY PORTABLE RUMBLE STRIP
-  TYPE III BARRICADE

NOT TO SCALE



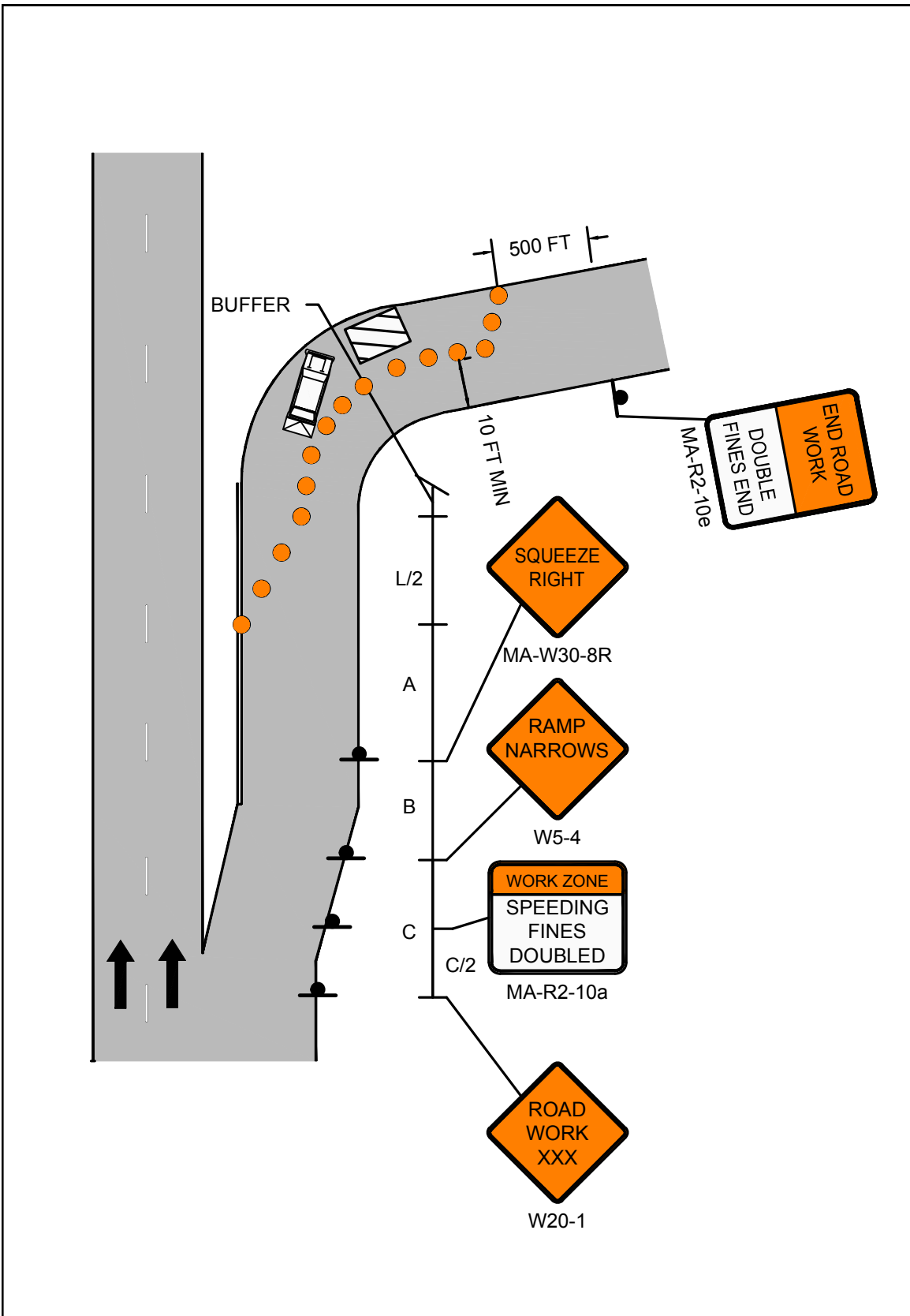

|  |  |  |
|--|--|--|
|  | Work Zone Safety Standard Details and Drawings | FIGURE 18<br>STATIONARY OPERATIONS<br>MULTILANE DIVIDED ROADWAY<br>LEFT SIDE OF OFF RAMP CLOSED<br>PAGE 43 |
|--|--|--|



PAGE 44

Work Zone Safety  
Standard Details  
and Drawings

STATIONARY OPERATIONS  
MULTILANE DIVIDED ROADWAY  
ROADWORK BEYOND ON RAMP

| POSTED SPEED LIMIT (MPH) | CHANNELIZATION DEVICES (DRUMS OR CONES) |                                     |                         |                     |                   |
|--------------------------|---|-------------------------------------|-------------------------|---------------------|-------------------|
|                          | SHOULDER TAPER LENGTH (L/3) (FT)        | TRAVEL LANE CLOSURE LENGTH (L) (FT) | BUFFER ZONE LENGTH (FT) | DEVICE SPACING (FT) | MIN # OF DEVICES* |
| 25-40                    | 110                                     | 320                                 | 305                     | 20                  | 175               |
| 45-55                    | 220                                     | 660                                 | 495                     | 40                  | 135               |
| 60-65                    | 260                                     | 780                                 | 645                     | 40                  | 155               |









\* NUMBER OF DEVICES BASED ON 400 FT WORK ZONE.

| POSTED SPEED LIMIT (MPH) | SPACING FOR ADVANCE WARNING SIGNS (FT) (A,B,C) |
|--------------------------|--|
| 25-40                    | 500 / 500 / 500                                |
| 45-55                    | 500 / 1000 / 1000                              |
| 60-65                    | 1000 / 1600 / 2600                             |

**NOTES**

1. MA-R2-10a LOCATED AT C/2.

**LEGEND**

-  WORK ZONE
-  CHANNELIZATION DEVICE
-  FLASHING ARROW BOARD
-  PORTABLE CHANGEABLE MESSAGE SIGN
-  TRUCK MOUNTED ATTENUATOR
-  RADAR SPEED FEEDBACK BOARD
-  POLICE DETAIL OR UNIFORMED FLAGGER
-  TEMPORARY PORTABLE RUMBLE STRIP
-  TYPE III BARRICADE

NOT TO SCALE

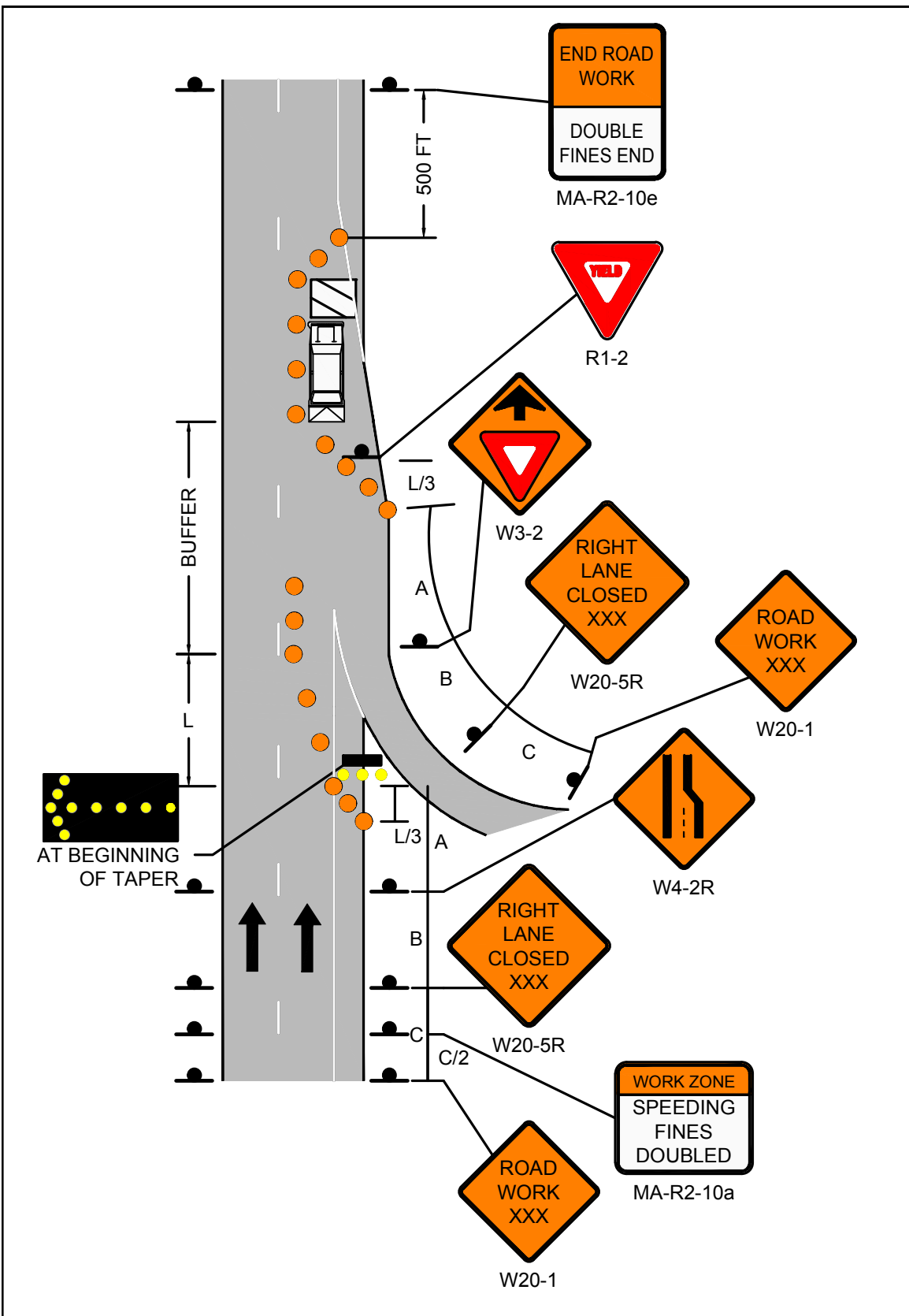

|  |  |  |
|--|--|--|
| <br>Massachusetts Department of Transportation<br>Highway Division<br>PAGE 46 | Work Zone Safety<br>Standard Details<br>and Drawings | STATIONARY OPERATIONS<br>MULTILANE DIVIDED ROADWAY<br>ROADWORK BEYOND OFF RAMP |
|--|--|--|

| POSTED SPEED LIMIT (MPH) | CHANNELIZATION DEVICES (DRUMS OR CONES) |                                     |                                     |                         |                     |                   |
|--------------------------|---|-------------------------------------|-------------------------------------|-------------------------|---------------------|-------------------|
|                          | SHOULDER TAPER LENGTH (L/3) (FT)        | TRAVEL LANE CLOSURE LENGTH (L) (FT) | TRAVEL LANE SHIFT LENGTH (L/2) (FT) | BUFFER ZONE LENGTH (FT) | DEVICE SPACING (FT) | MIN # OF DEVICES* |
| 25-40                    | 110                                     | 320                                 | 160                                 | 305                     | 20                  | 70                |
| 45-55                    | 220                                     | 660                                 | 330                                 | 495                     | 40                  | 55                |
| 60-65                    | 260                                     | 780                                 | 390                                 | 645                     | 40                  | 65                |









\* NUMBER OF DEVICES BASED ON 400 FT WORK ZONE.

| POSTED SPEED LIMIT (MPH) | SPACING FOR ADVANCE WARNING SIGNS (FT) (A,B,C) |
|--------------------------|--|
| 25-40                    | 500 / 500 / 500                                |
| 45-55                    | 500 / 1000 / 1000                              |
| 60-65                    | 1000 / 1600 / 2600                             |

**NOTES**

1. MA-R2-10a LOCATED AT C/2.

**LEGEND**

-  WORK ZONE
-  CHANNELIZATION DEVICE
-  FLASHING ARROW BOARD
-  PORTABLE CHANGEABLE MESSAGE SIGN
-  TRUCK MOUNTED ATTENUATOR
-  RADAR SPEED FEEDBACK BOARD
-  POLICE DETAIL OR UNIFORMED FLAGGER
-  TEMPORARY PORTABLE RUMBLE STRIP
-  TYPE III BARRICADE

NOT TO SCALE

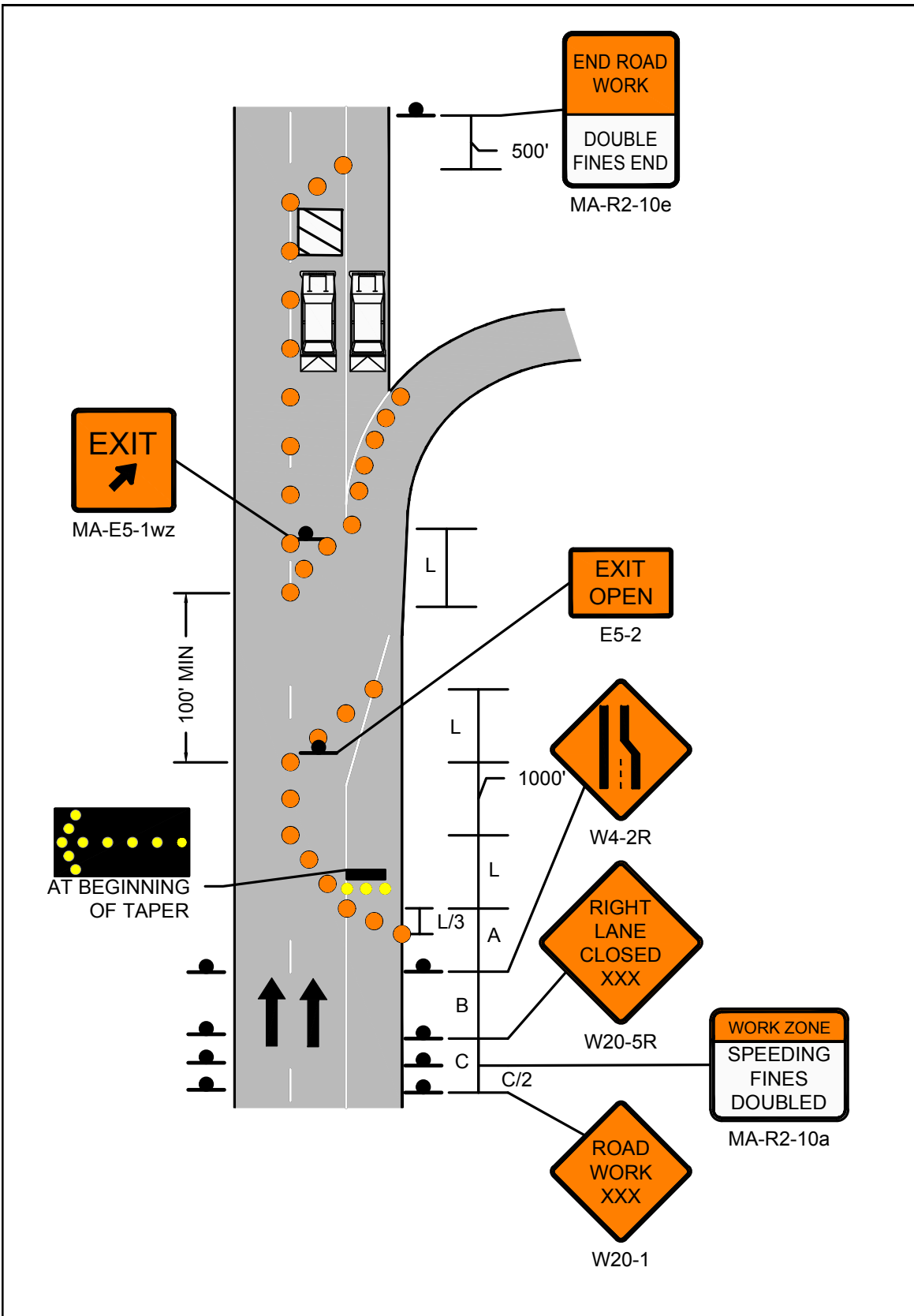

|  |   |   |
|--|---|---|
|  <p>PAGE 47</p> | <p>Work Zone Safety Standard Details and Drawings</p> | <p>FIGURE 20<br/>STATIONARY OPERATIONS<br/>MULTILANE DIVIDED ROADWAY<br/>ROADWORK BEYOND OFF RAMP</p> |
|--|---|---|



PAGE 48

Work Zone Safety  
Standard Details  
and Drawings









MULTILANE DIVIDED ROADWAY  
TYPICAL RAMP CLOSURE

| POSTED SPEED LIMIT (MPH) | SPACING FOR ADVANCE WARNING SIGNS (FT) (A,B,C) | CHANNELIZATION DEVICES (DRUMS OR CONES) |                         |                     |                  |
|--------------------------|--|---|-------------------------|---------------------|------------------|
|                          |  | SHOULDER TAPER LENGTH (L/3) (FT)        | BUFFER ZONE LENGTH (FT) | DEVICE SPACING (FT) | MIN # OF DEVICES |
| 25-40                    | 500 / 500 / 500                                | 110                                     | 305                     | 20                  | 45               |
| 45-55                    | 500 / 1000 / 1000                              | 220                                     | 495                     | 40                  | 30               |
| 60-65                    | 1000 / 1600 / 2600                             | 260                                     | 645                     | 40                  | 35               |

NOTES

1. MA-R2-10a LOCATED AT C/2.
2. \* NOT REQUIRED IF RIGHT LANE IS CLOSED IN ADVANCE OF EXIT.
3. \*\* OPTIONAL AT ENGINEER'S DISCRETION.

LEGEND

-  WORK ZONE
-  CHANNELIZATION DEVICE
-  FLASHING ARROW BOARD
-  PORTABLE CHANGEABLE MESSAGE SIGN
-  TRUCK MOUNTED ATTENUATOR
-  RADAR SPEED FEEDBACK BOARD
-  POLICE DETAIL OR UNIFORMED FLAGGER
-  TEMPORARY PORTABLE RUMBLE STRIP
-  TYPE III BARRICADE

NOT TO SCALE

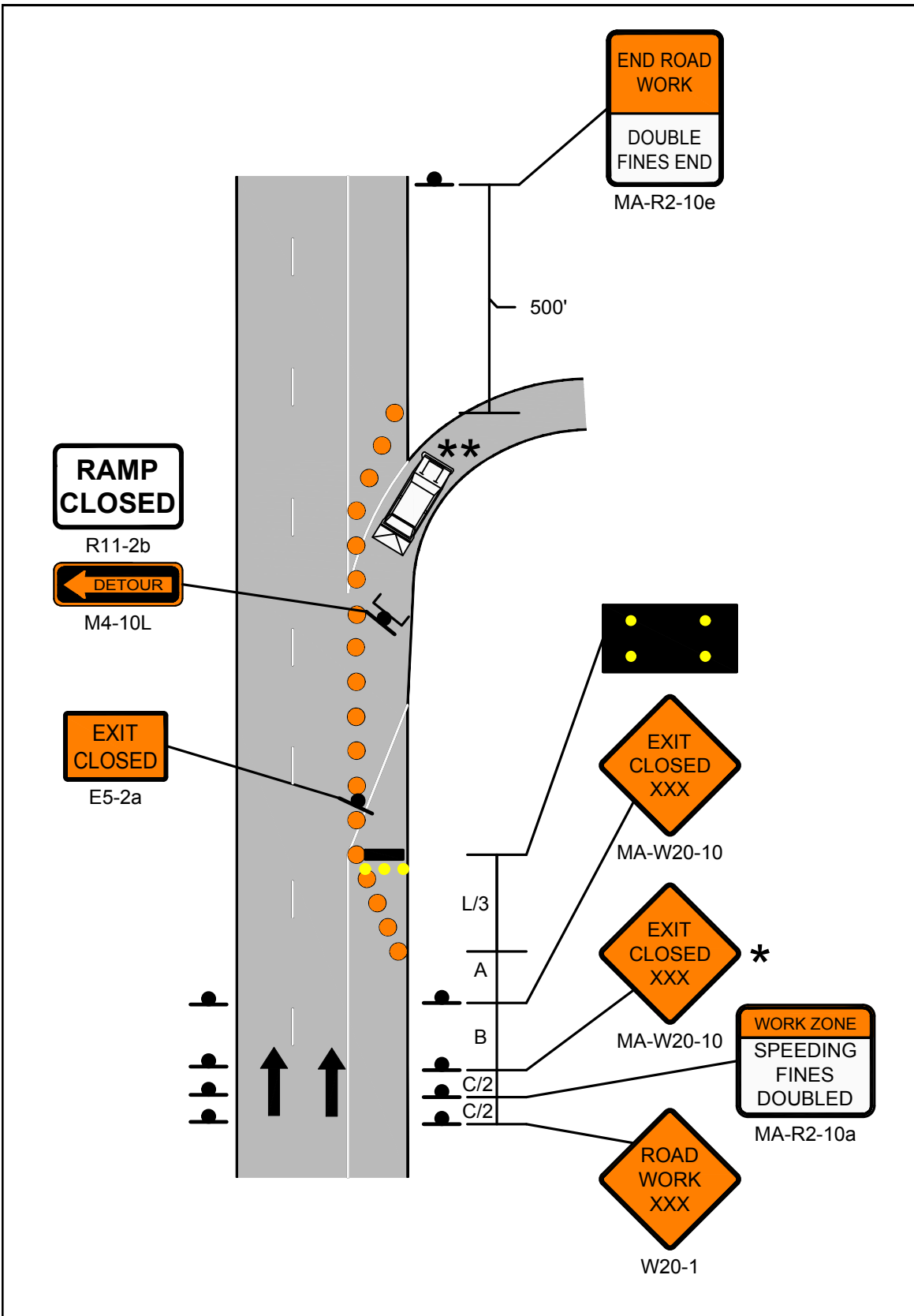

|  |   |   |
|--|---|---|
|  <p>PAGE 49</p> | <p>Work Zone Safety<br/>Standard Details<br/>and Drawings</p> | <p>FIGURE 21<br/>MULTILANE DIVIDED ROADWAY<br/>TYPICAL RAMP CLOSURE</p> |
|--|---|---|



PAGE 50

Work Zone Safety  
Standard Details  
and Drawings









MULTILANE DIVIDED ROADWAY  
TYPICAL CLOVERLEAF RAMP CLOSURE

| POSTED SPEED LIMIT (MPH) | SPACING FOR ADVANCE WARNING SIGNS (FT) (A,B,C) | CHANNELIZATION DEVICES (DRUMS OR CONES) |                         |                     |                  |
|--------------------------|--|---|-------------------------|---------------------|------------------|
|                          |  | SHOULDER TAPER LENGTH (L/3) (FT)        | BUFFER ZONE LENGTH (FT) | DEVICE SPACING (FT) | MIN # OF DEVICES |
| 25-40                    | 500 / 500 / 500                                | 110                                     | 305                     | 20                  | 45               |
| 45-55                    | 500 / 1000 / 1000                              | 220                                     | 495                     | 40                  | 30               |
| 60-65                    | 1000 / 1600 / 2600                             | 260                                     | 645                     | 40                  | 35               |

**NOTES**

1. MA-R2-10a LOCATED AT C/2.
2. \* NOT REQUIRED IF RIGHT LANE IS CLOSED IN ADVANCE OF EXIT.
3. \*\* OPTIONAL AT ENGINEER'S DISCRETION.

**LEGEND**

-  WORK ZONE
-  CHANNELIZATION DEVICE
-  FLASHING ARROW BOARD
-  PORTABLE CHANGEABLE MESSAGE SIGN
-  TRUCK MOUNTED ATTENUATOR
-  RADAR SPEED FEEDBACK BOARD
-  POLICE DETAIL OR UNIFORMED FLAGGER
-  TEMPORARY PORTABLE RUMBLE STRIP
-  TYPE III BARRICADE

NOT TO SCALE



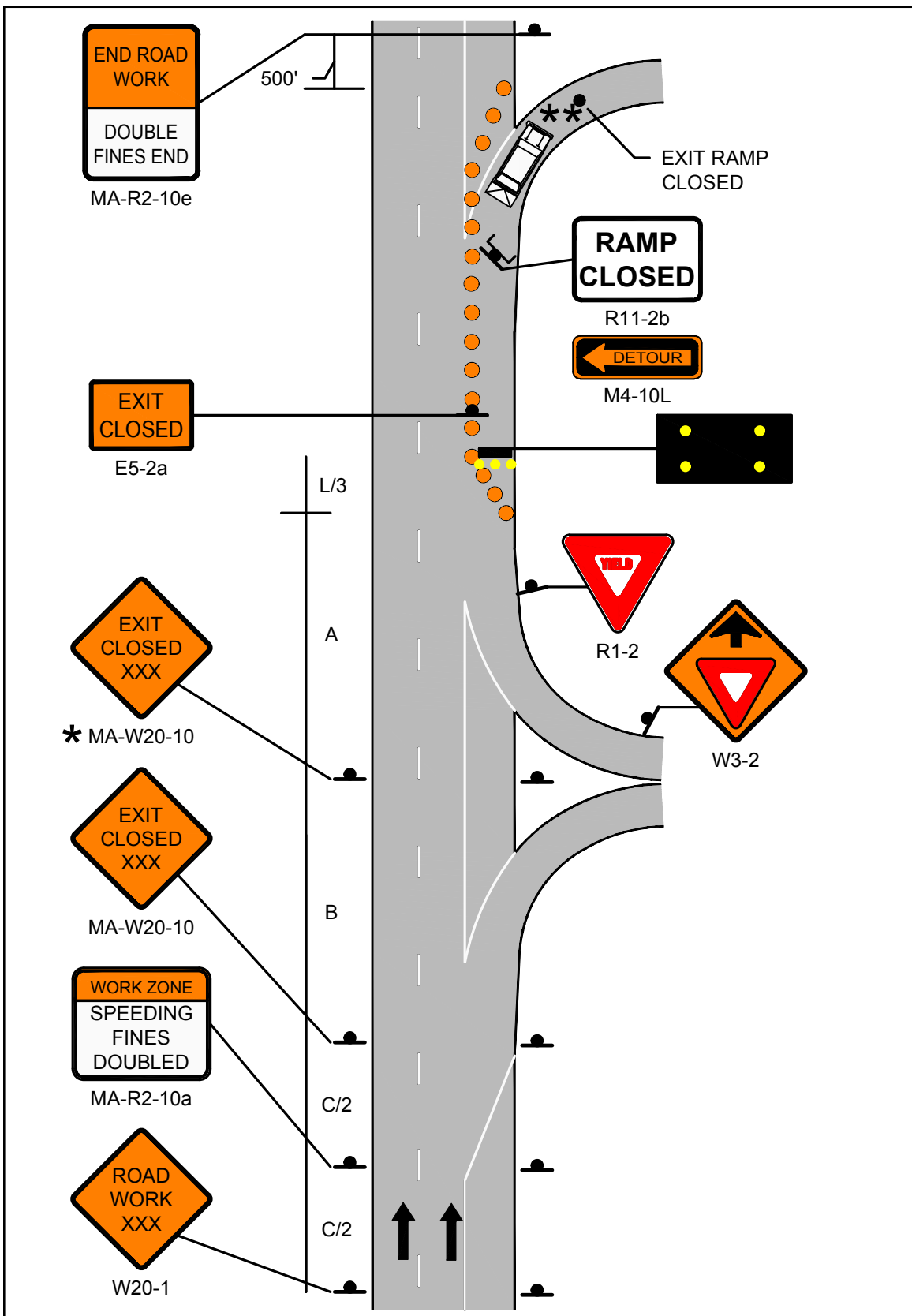









|  |   |  |
|--|---|--|
|  <p>PAGE 51</p> | <p>Work Zone Safety<br/>Standard Details<br/>and Drawings</p> | <p>FIGURE 22<br/>MULTILANE DIVIDED ROADWAY<br/>TYPICAL CLOVERLEAF RAMP CLOSURE</p> |
|--|---|--|

|  |   |   |
|--|---|---|
|  <p>PAGE 52</p> | <p>Work Zone Safety<br/>Standard Details<br/>and Drawings</p> | <p>MULTILANE DIVIDED ROADWAY<br/>TYPICAL RAMP CLOSURE<br/>ADVANCE SIGNING</p> |
|--|---|---|

NOTES

1. IF THE CLOSED RAMP IS LOCATED DOWNSTREAM FROM THE PROPOSED DETOUR ROUTE/RAMP, A PCMS SHALL BE POSITIONED AT A SUFFICIENT DISTANCE IN ADVANCE OF THE DETOUR ROUTE/RAMP AND SHOULD STATE WHICH RAMP IS CLOSED AND WHICH SHALL BE USED FOR THE DETOUR.
  
2. IF THE CLOSED RAMP IS LOCATED UPSTREAM FROM THE PROPOSED DETOUR ROUTE/RAMP, A PCMS SHALL BE POSITIONED PRIOR TO THE CLOSED RAMP AND SHOULD STATE WHICH RAMP IS CLOSED AND WHICH SHALL BE USED FOR THE DETOUR.
  
3. A SUFFICIENT NUMBER OF DETOUR SIGNS (M4-9 SERIES) SHOULD BE DEPLOYED TO PROPERLY DIRECT DETOURED TRAFFIC. SIGN SPACING SHALL BE AT THE DIRECTION OF THE ENGINEER.

LEGEND

-  WORK ZONE
-  CHANNELIZATION DEVICE
-  FLASHING ARROW BOARD
-  PORTABLE CHANGEABLE MESSAGE SIGN
-  TRUCK MOUNTED ATTENUATOR
-  RADAR SPEED FEEDBACK BOARD
-  POLICE DETAIL OR UNIFORMED FLAGGER
-  TEMPORARY PORTABLE RUMBLE STRIP
-  TYPE III BARRICADE

NOT TO SCALE

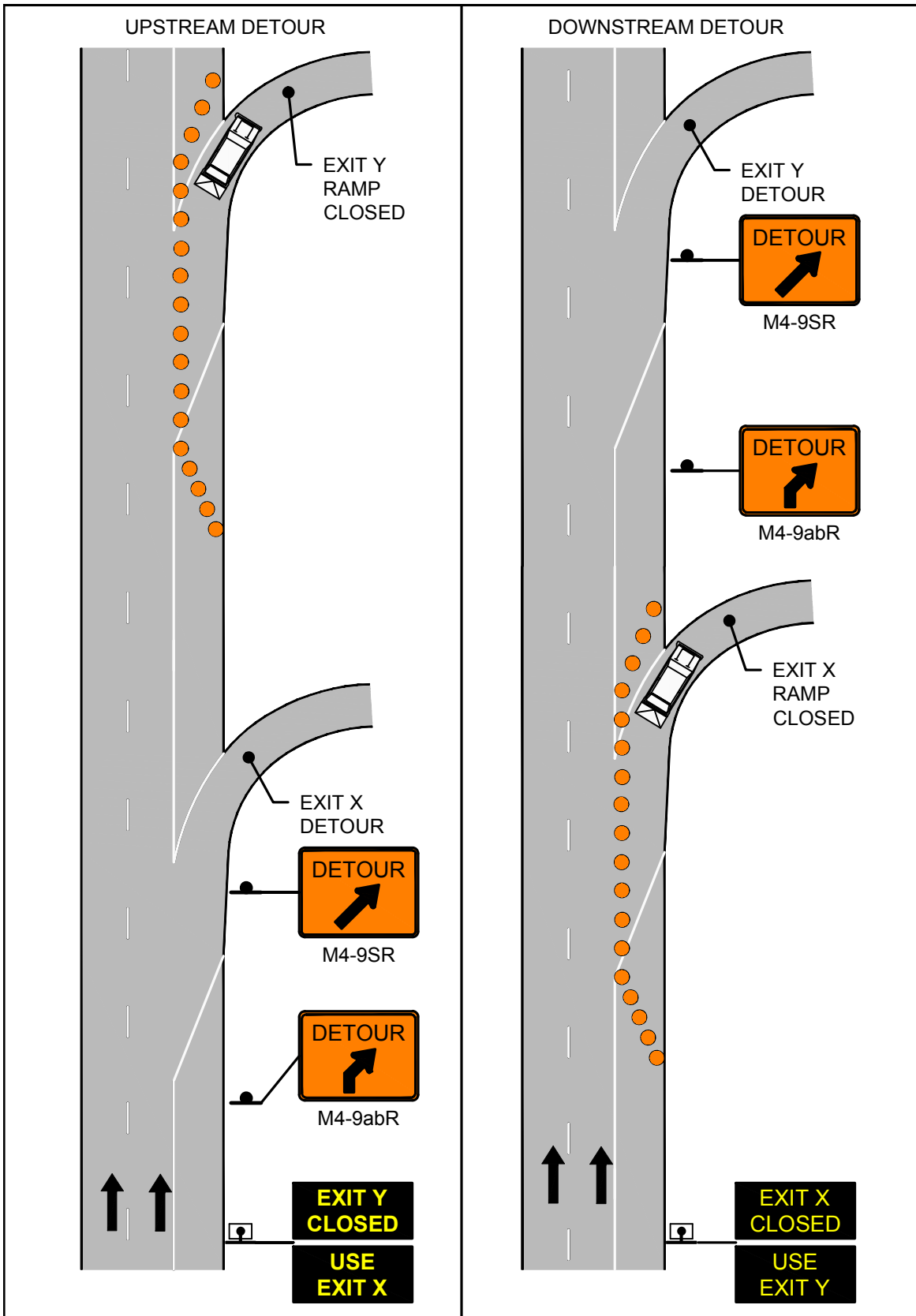



FIGURE 23  
MULTILANE DIVIDED ROADWAY  
TYPICAL RAMP CLOSURE  
ADVANCE SIGNING

|  |  |  |
|--|--|--|
| <br>MASSACHUSETTS DEPARTMENT OF TRANSPORTATION<br>HIGHWAY DIVISION<br>PAGE 54 | Work Zone Safety<br>Standard Details<br>and Drawings | FIGURE 24-1<br>MULTILANE DIVIDED ROADWAY<br>PLACEMENT OF TEMPORARY<br>PORTABLE RUMBLE STRIPS<br>SHEET 1 OF 2 |
|--|--|--|

| POSTED REGULATORY OR WORK ZONE SPEED | SEPARATION BETWEEN RUMBLE STRIPS |
|--------------------------------------|----------------------------------|
| Above 55-mph                         | 20-feet                          |
| 36-mph to 55-mph                     | 15-feet                          |
| 35-mph and under                     | 10-feet                          |

| POSTED SPEED LIMIT (MPH) | SPACING FOR ADVANCE WARNING SIGNS (FT) (A,B,C) | TANGENT LENGTH BETWEEN TAPERS (T) (FT) |
|--------------------------|--|--|
| 25-40                    | 500 / 500 / 500                                | 640                                    |
| 45-55                    | 500 / 1000 / 1000                              | 1320                                   |
| 60-65                    | 1000 / 1600 / 2600                             | 1560                                   |

**NOTES**

1. THE INTENTION OF THESE DETAILS IS ONLY TO DEPICT THE PLACEMENT OF TEMPORARY PORTABLE RUMBLE STRIPS (TPRS) IN RELATIONSHIP TO THE TAPER AND THE BUFFER OF A SINGLE- OR MULTI-LANE CLOSURE. THE DEPICTION OF THE NUMBER AND SPACING OF ALL OTHER TRAFFIC CONTROL DEVICES IS NOT TO SCALE. REFER TO OTHER DETAILS FOR LANE CLOSURES FOR THE PLACEMENT AND NUMBER OF ALL OTHER TRAFFIC CONTROL DEVICES.
2. THESE DETAILS ONLY DEPICT RIGHT LANE CLOSURES. LEFT LANE CLOSURES SHOULD UTILIZE A MIRROR IMAGE OF THESE SETUPS, STARTING WITH CLOSURE OF THE LEFTMOST LANE.
3. ★ THIS TPRS ARRAY IS OPTIONAL AT THE ENGINEER'S DISCRETION. IF USED, IT SHOULD BE PLACED ADJACENT TO THE BUFFER.
4. DETAILS SHOW THE MINIMUM NUMBER OF TPRS REQUIRED. ADDITIONAL MAY BE USED IF CONDITIONS WARRANT.

**LEGEND**

- CHANNELIZATION DEVICE
- TRUCK MOUNTED ATTENUATOR
- TEMPORARY PORTABLE RUMBLE STRIP

NOT TO SCALE

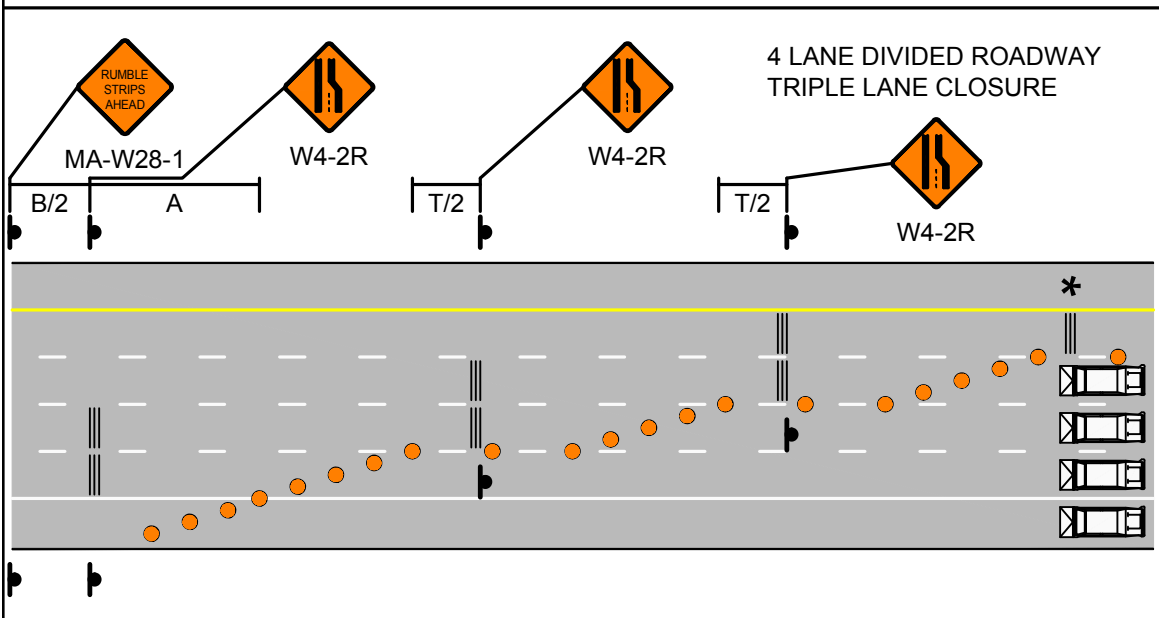

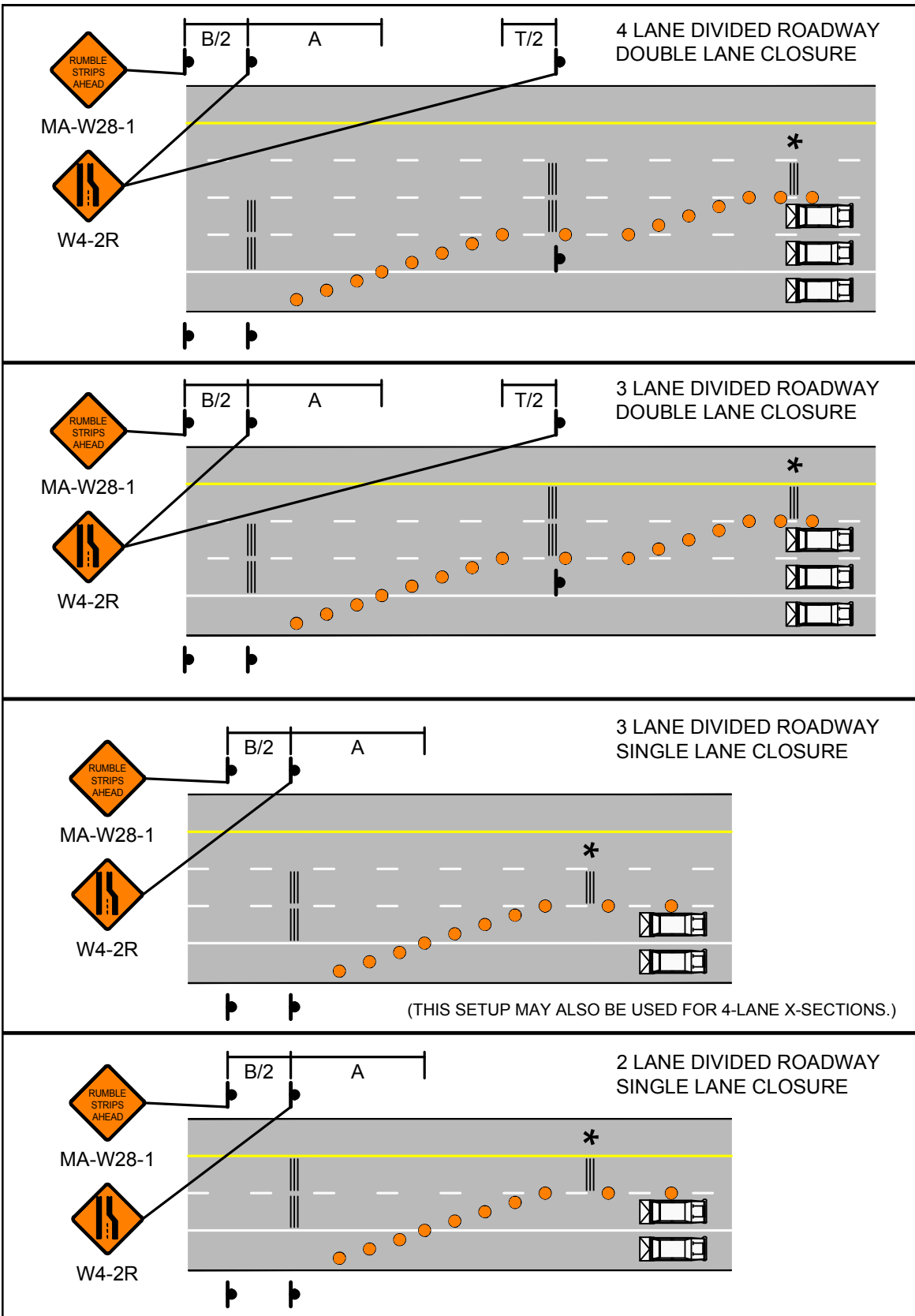

|   |   |                                    |
|---|---|------------------------------------|
|  <p>PAGE 56</p>  | <p>Work Zone Safety<br/>Standard Details<br/>and Drawings</p> | <p>NOTES FOR MOBILE OPERATIONS</p> |
| <p style="text-align: center;"><b>Notes for Mobile Operations</b></p> <ul style="list-style-type: none"> <li>• Unless otherwise stated, these notes shall apply to all Mobile Operation setups.</li> <li>• Additional, setup-specific notes may be found on individual sheets.</li> </ul> <ol style="list-style-type: none"> <li>1. The Supervisor shall travel the designated roadway prior to scheduling the work to ensure that sufficient and appropriate traffic control devices will be available. Special consideration shall be exercised to ensure that appropriate traffic controls be placed in areas that will have limited visibility of the work areas or any associated traffic queues.</li> <li>2. Vehicles used for these operations shall be made highly visible with appropriate equipment such as flashing lights, rotating beacons, flags, signs, flashing arrow boards, and/or portable changeable message signs. Any signs mounted to these vehicles shall not obscure the visibility of other devices.</li> <li>3. All vehicles shown may not be required based upon roadway conditions. However, when needed and practical, additional shadow vehicles and equipment to warn and protect motorists and workers should be used. Based upon roadway conditions, the addition of a police detail with cruiser may be used for additional protection or warning for the traveling public.</li> <li>4. The distance between the work and shadow vehicle(s) may vary according to the terrain and other factors. Shadow vehicles are used to warn traffic of the operations ahead. Whenever adequate sight distance exists, the shadow vehicle(s) should maintain the minimum appropriate distance and maintain the same speed to prevent non-work related vehicles from entering the work convoy. If this formation cannot be maintained then additional traffic control devices should be deployed in advance of any vertical or horizontal curves that may restrict the sight distance of an oncoming vehicle to either the work vehicle or associated traffic queue.</li> <li>5. All shadow vehicles shall be equipped with a truck or trailer mounted attenuator (TMA) and a flashing arrow board.</li> <li>6. Signs should be covered or turned from view when work is not in progress.</li> <li>7. Portable changeable message signs may be used in lieu of MA-W21-9 signs and any signs mounted directly to a shadow vehicle.</li> </ol> |   |                                    |

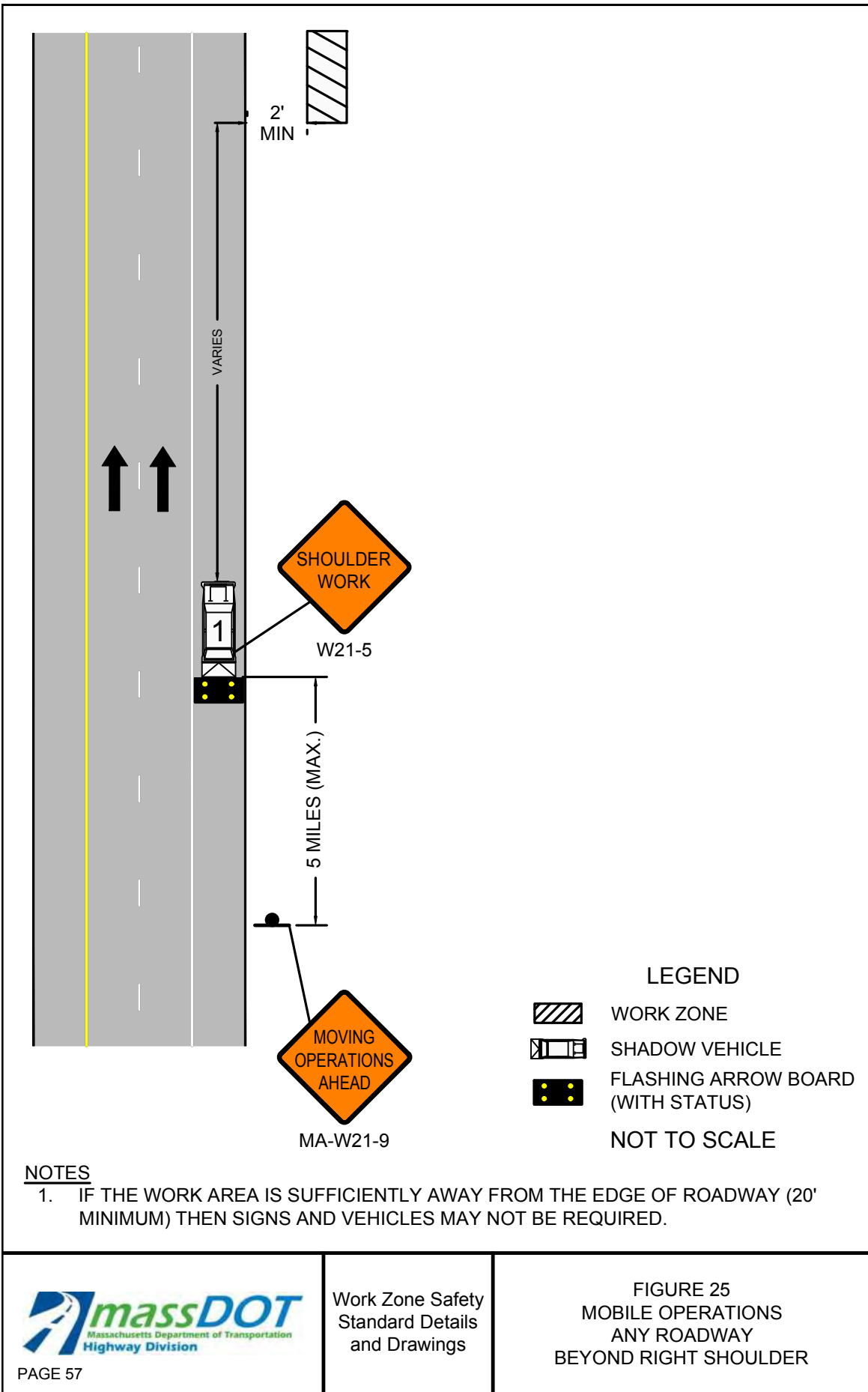

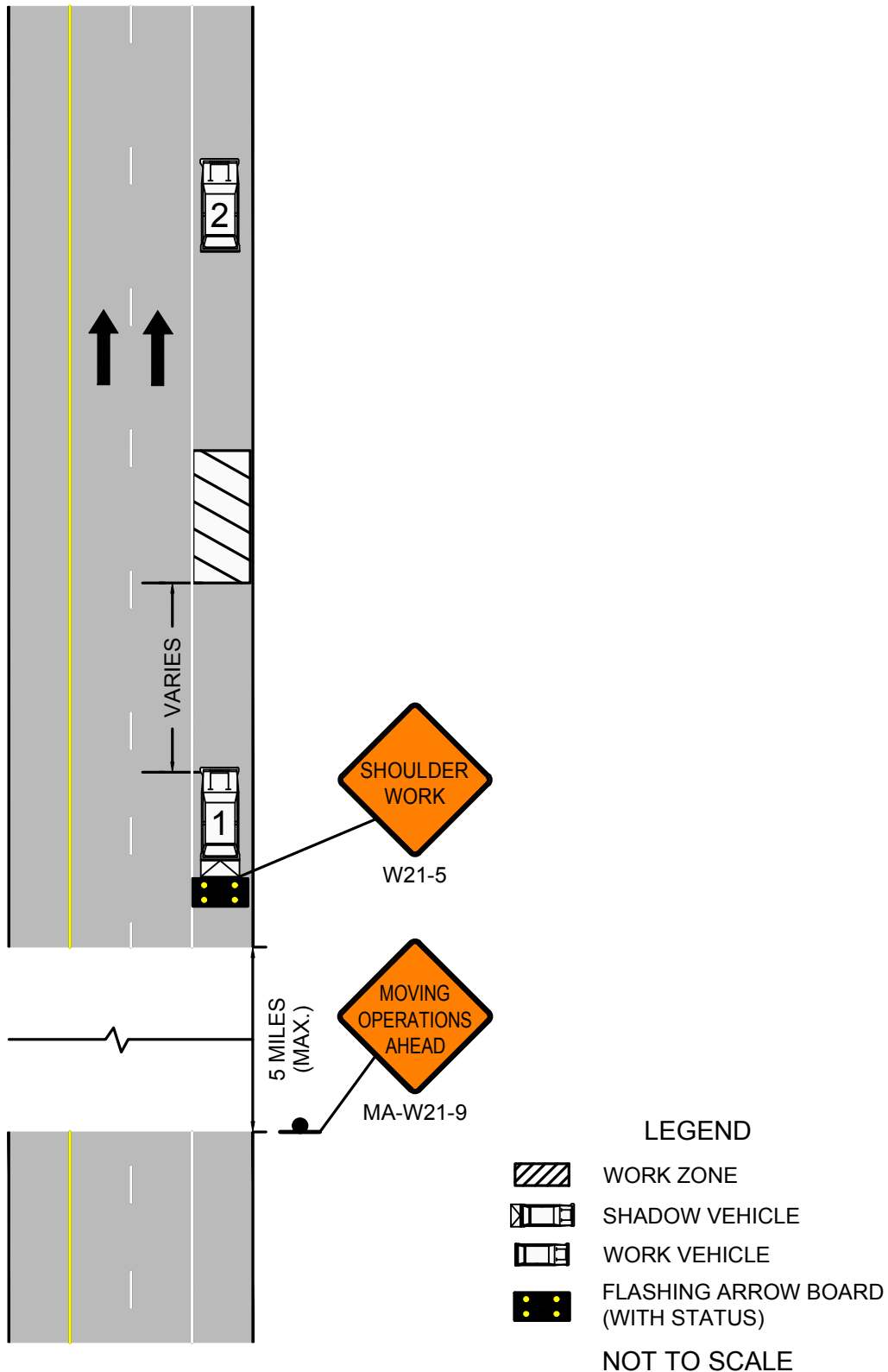



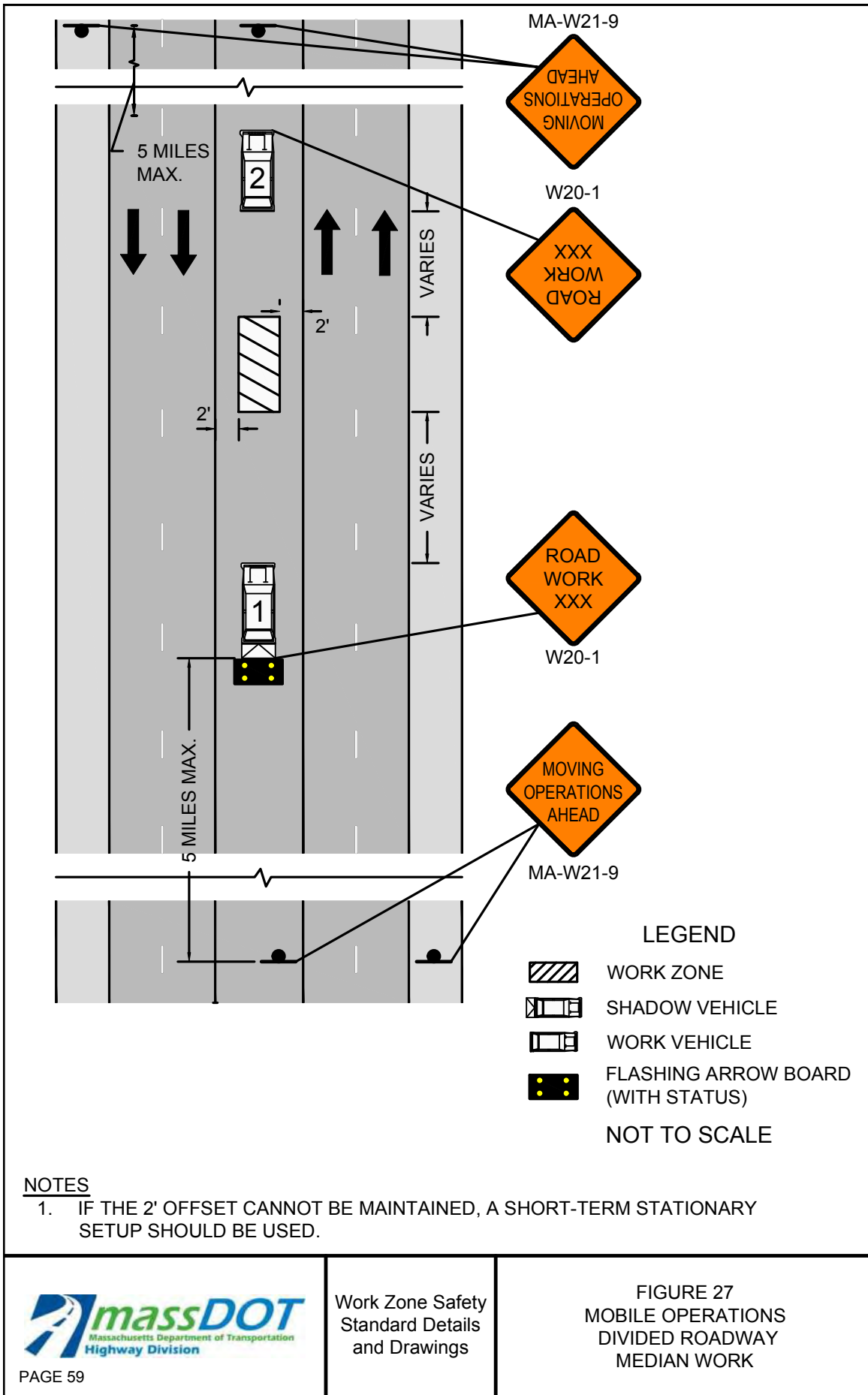
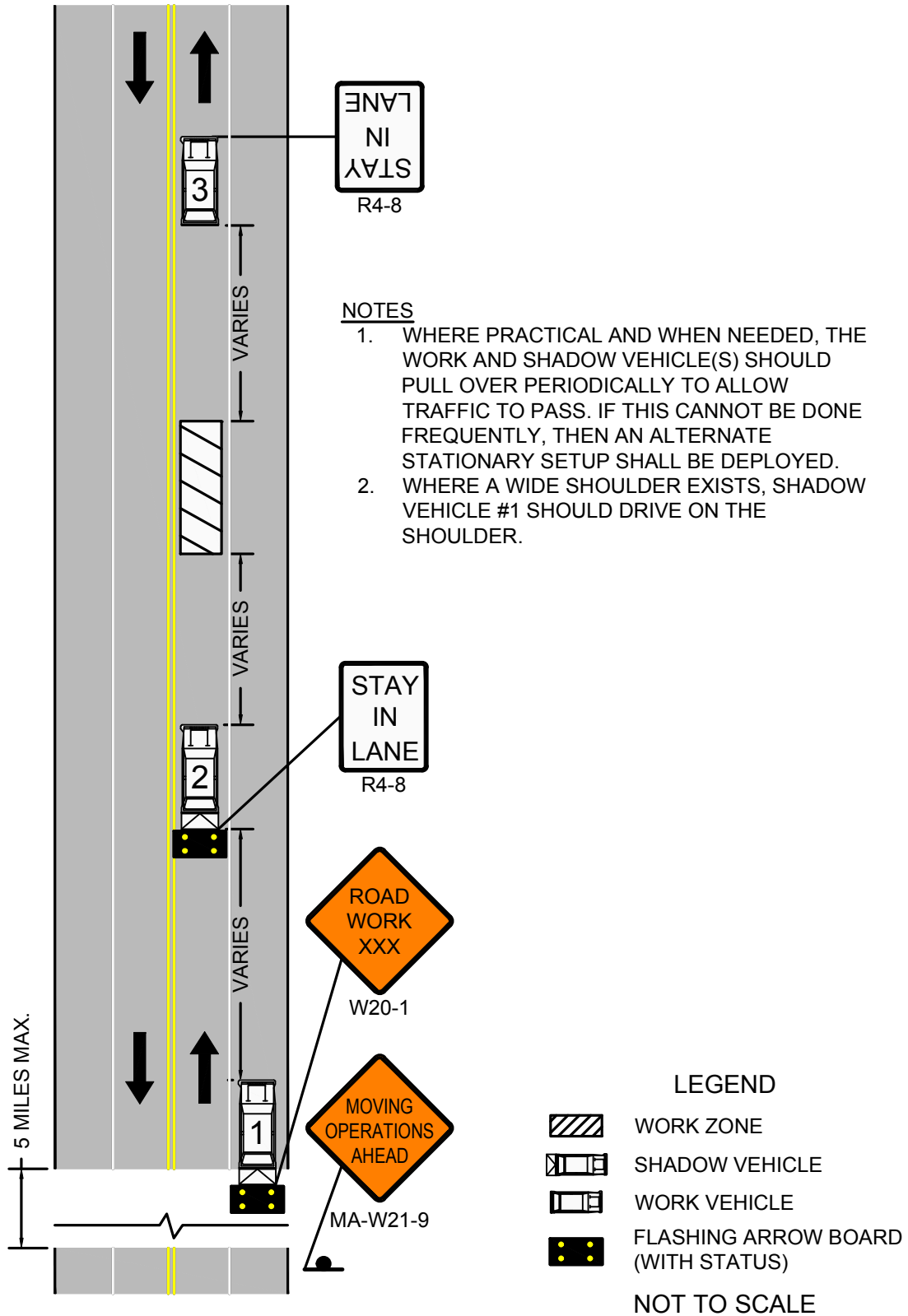



FIGURE 28  
MOBILE OPERATIONS  
UNDIVIDED TWO LANE ROADWAY  
HALF OF ROADWAY CLOSED



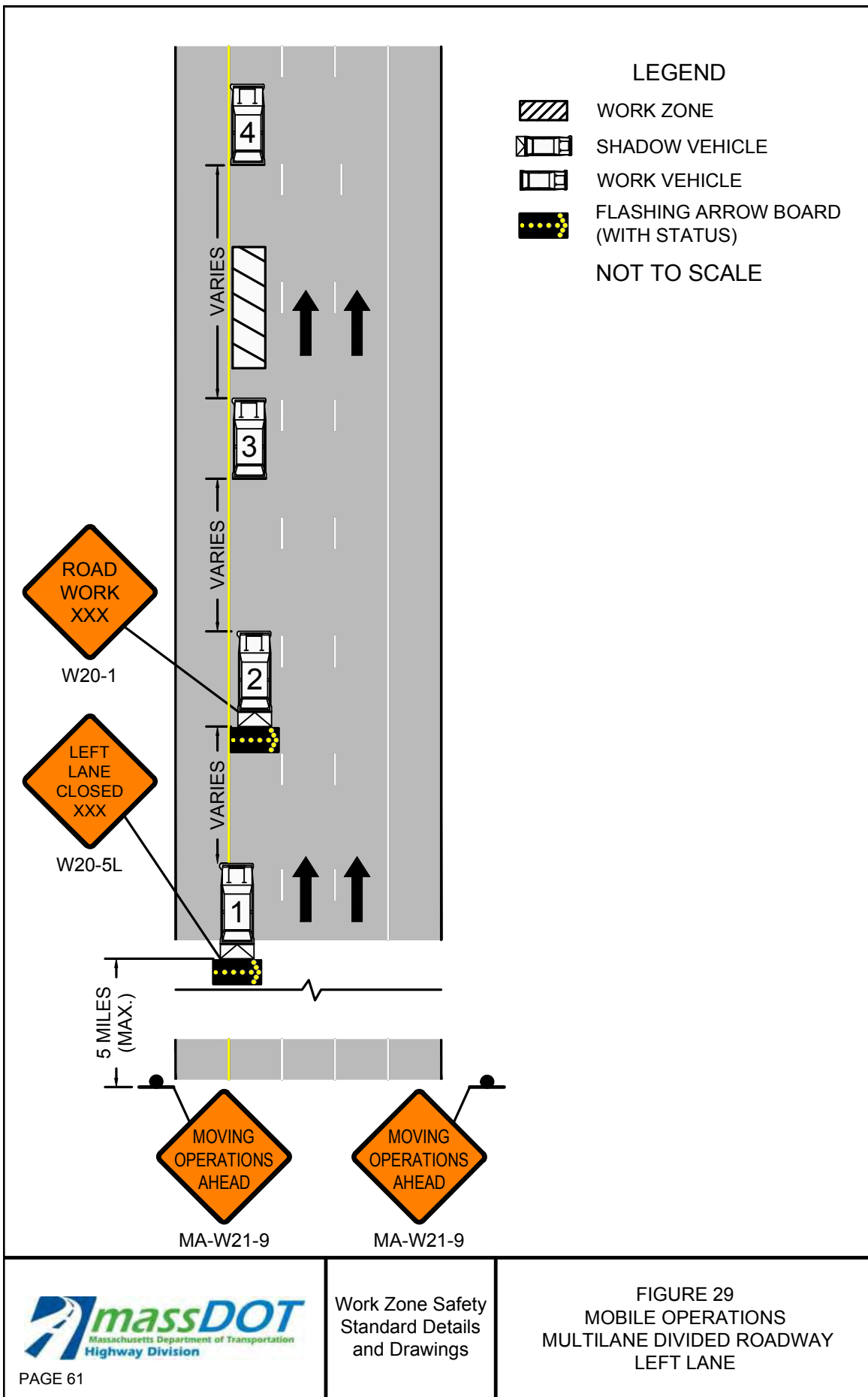
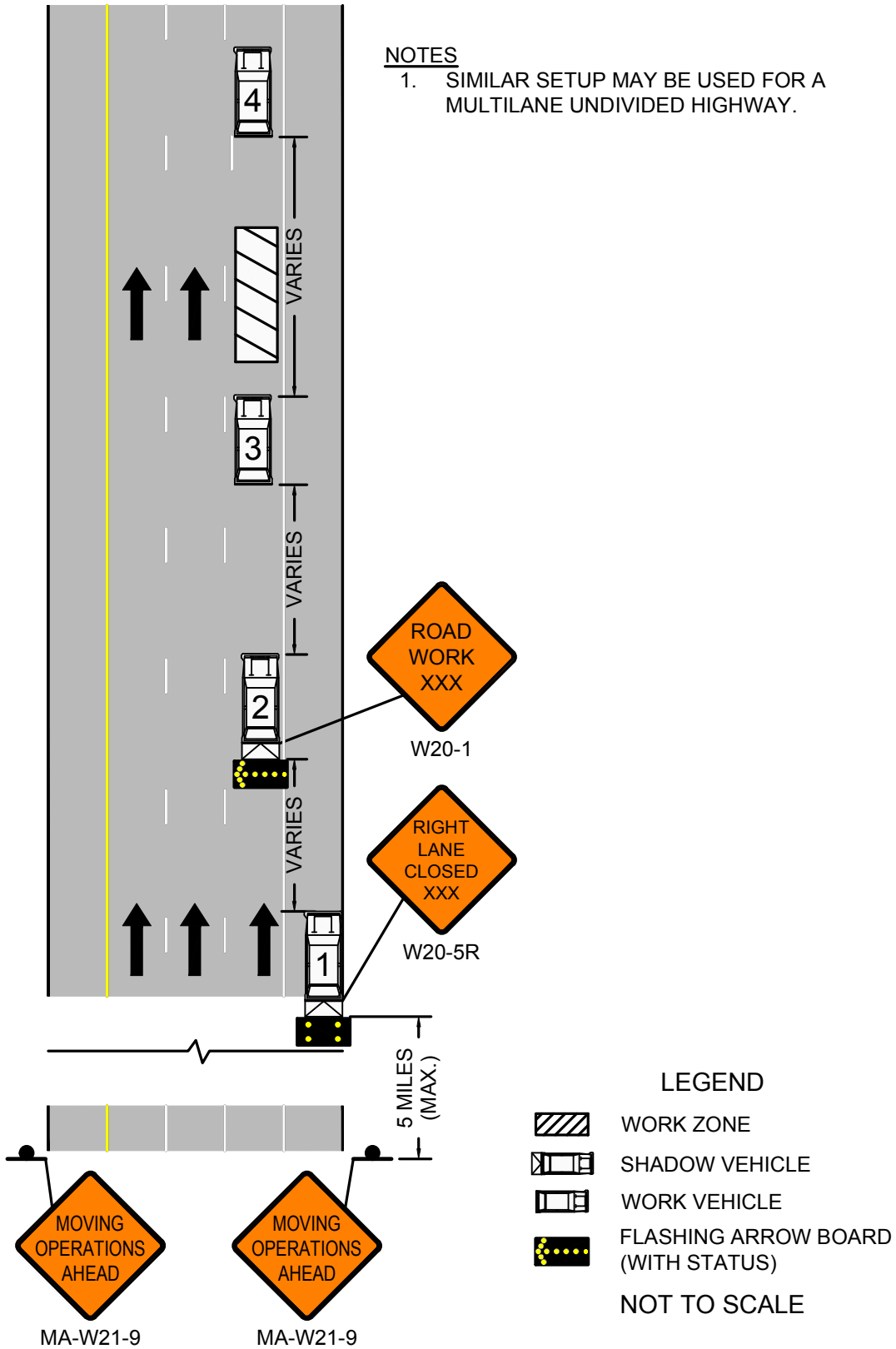
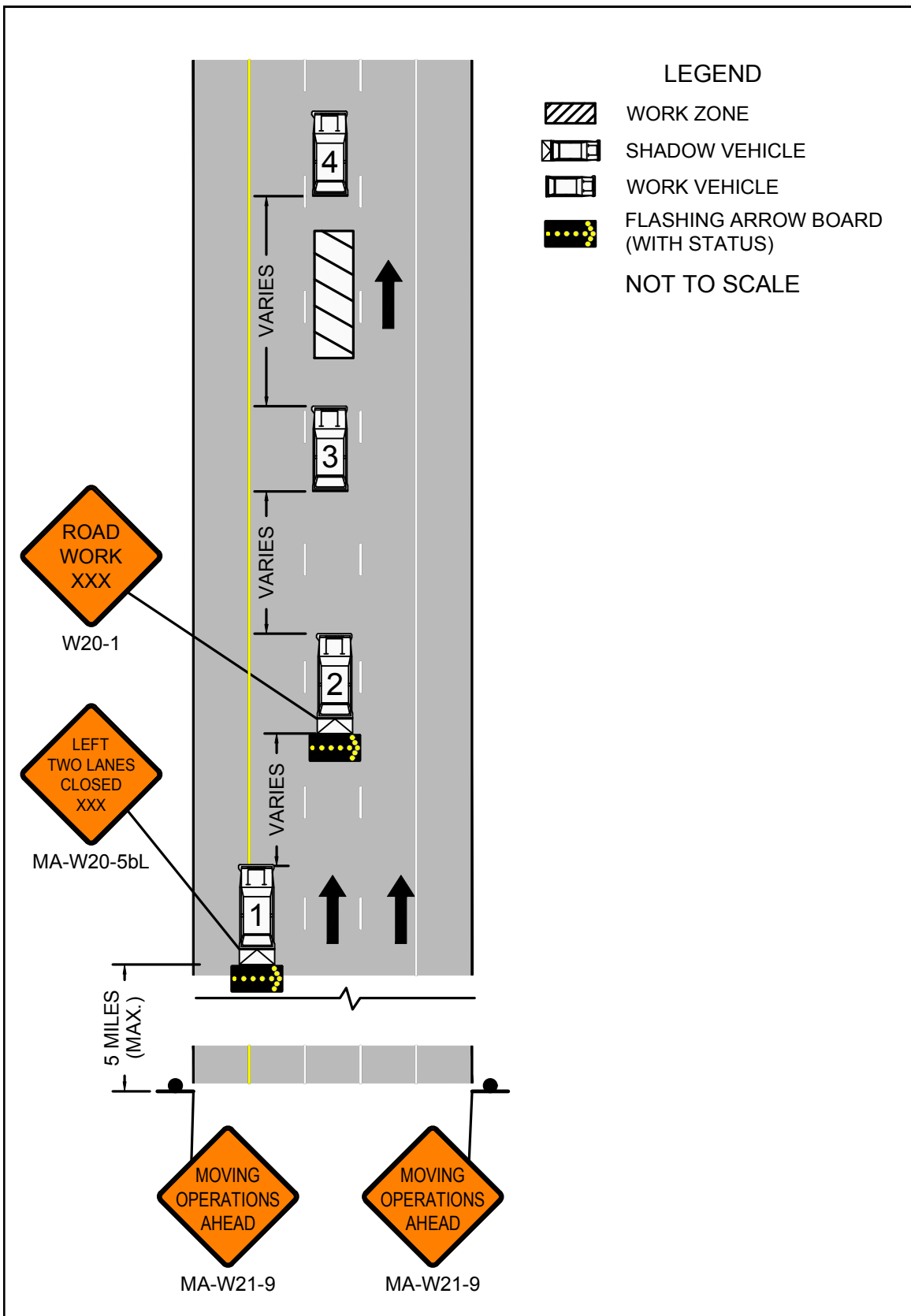
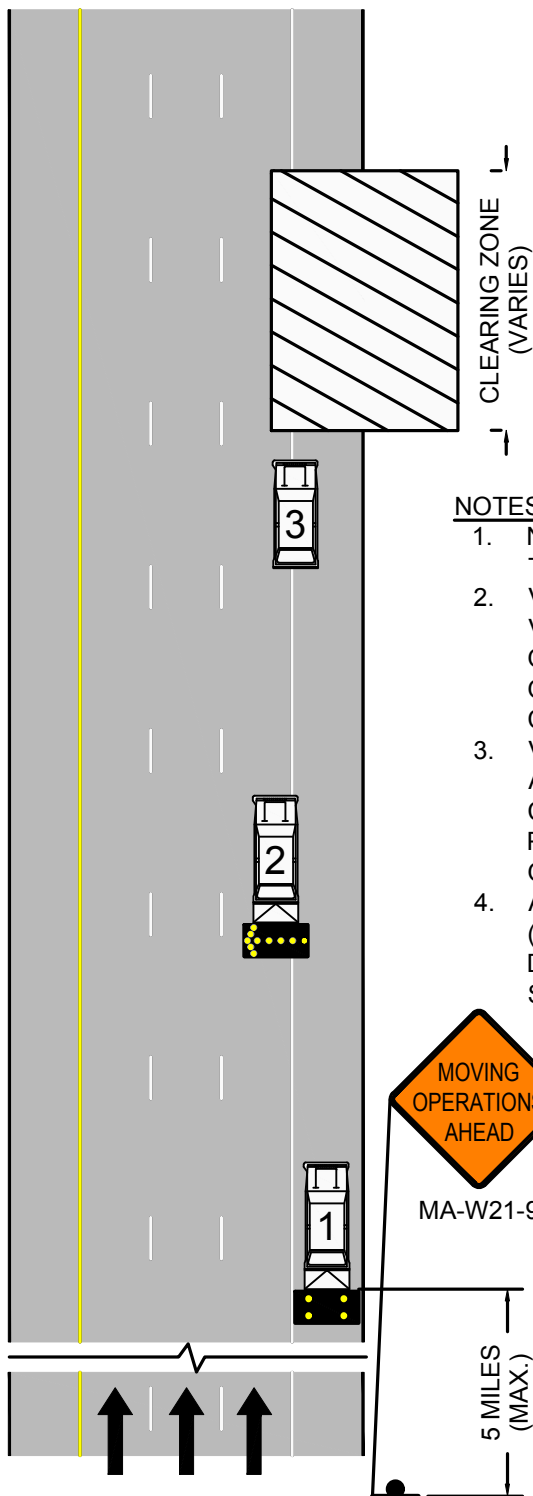



FIGURE 30  
MOBILE OPERATIONS  
MULTILANE DIVIDED ROADWAY  
RIGHT LANE











**NOTES**

1. NO OTHER NOTES ARE APPLICABLE TO THIS DETAIL.
2. VEHICLE #3 IS A SNOW/DEBRIS REMOVAL VEHICLE AND SHALL ALWAYS BE AWARE OF THE SURROUNDINGS. MORE THAN ONE VEHICLE MAY BE USED IN THE CLEARING ZONE.
3. VEHICLE #1 SHOULD BE EQUIPPED WITH A PCMS, A TMA, AND STAY IN VISUAL CONTACT WITH VEHICLE #3 WHILE PROVIDING AMPLE WARNING TO ONCOMING TRAFFIC.
4. A POLICE DETAIL WITH BLUE LIGHTS (OPTIONAL) SHALL REMAIN DOWNSTREAM OF VEHICLE #1 IN THE SHOULDER.

**LEGEND**

-  WORK ZONE
-  SHADOW VEHICLE
-  WORK VEHICLE
-  FLASHING ARROW BOARD (WITH STATUS)

NOT TO SCALE

**Notes for Traffic Emergency or Incident Operations**

- The goal is to increase awareness of during traffic emergencies or incidents.
- These signs are to be used to differentiate from the traditional construction work zone and an emergency or incident.
- Upon arrival MassDOT First Responders shall assess the magnitude of the scene to determine if the incident is likely to last an hour or more in duration which would trigger the requirement to use these signs.
- Place the “Emergency Ahead” sign on the same side of the road as the incident, if possible, for up to an hour. Emergency response signs should be put up for all incidents and emergencies as soon as possible.
- Place the emergency sign 500 to 1000 feet before the first channelization devices.
- As an incident evolves this sign would be used as a secondary sign with all other emergency controls put in place.
- Only use “MERGE” signs where applicable (Not on 2 lane roads).
- Use MERGE signs on Multi-lane Roads to move traffic away from the incident and keep them in a safe lane.
- Place the MERGE sign about 500 feet before the closure.
- If additional signs are available, they should be placed accordingly as a sign informing people coming in the other direction or on the opposite side of the roadway.
- Use 12 emergency cones spaced 40 to 80 feet apart to form a taper and protect the scene.
- Sequential flashing lights/flares may be used in lieu of or to supplement cones.
- During a major incident that will last for a long duration, the EMERGENCY AHEAD sign should be moved back before an intersecting road or ramp to alert travelers and give them an option of using an alternate route. (Be sure all other devices are in place before moving this sign).

**Standard Emergency Signs (36"x36" or 48"x48")**



MA-W20-9

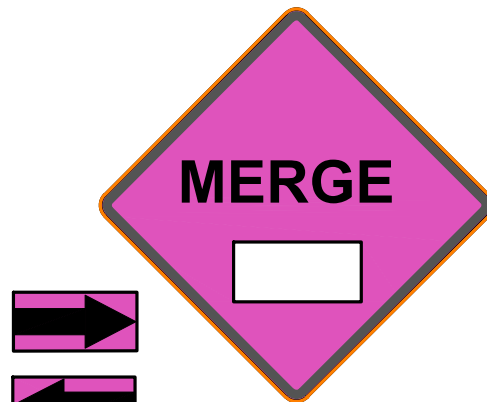



MA-W4-2aR/L



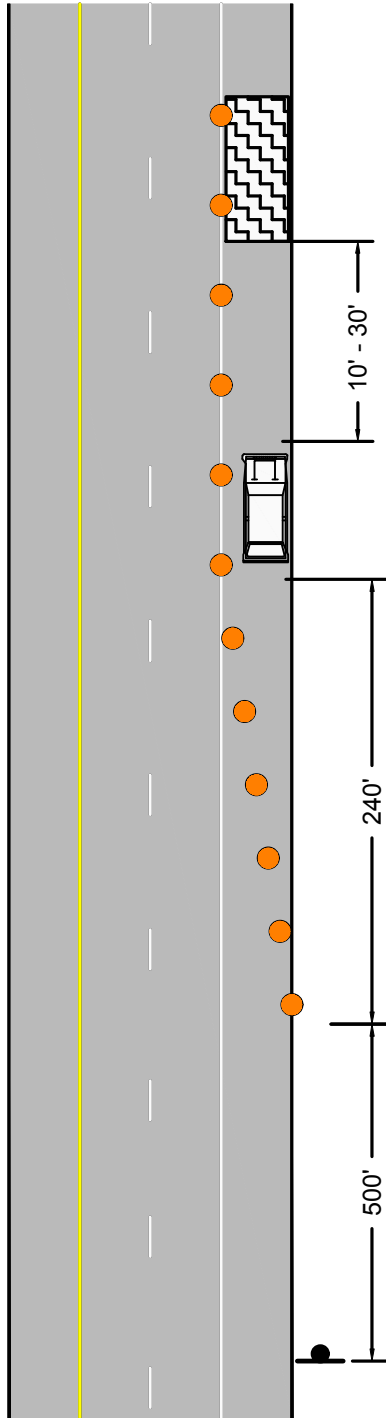

FIGURE 33  
EMERGENCY RESPONSE  
ANY ROADWAY  
SHOULDER ENCROACHMENT

LEGEND

-  EMERGENCY AREA
-  CHANNELIZATION DEVICE
-  EMERGENCY RESPONSE VEHICLE

NOT TO SCALE



ORDER OF RESPONSE ACTIVITIES

1. ACTIVATE HAZARD WARNING LIGHTS AND FLASHERS. PULL VEHICLE OVER TO THE RIGHT EDGE OF TRAVEL LANE BEFORE STOPPING.
2. IF EMERGENCY INVOLVES AN INJURY, SKIP TO STEP 4 THEN RETURN TO STEP 3.
3. ERECT SIGNS AND PLACE TRAFFIC CONES. USE 40' SPACING BETWEEN CONES.
4. TEND TO EMERGENCY/INCIDENT.

NOTES

1. ON HILLY TERRAIN, SHARP CURVES, IN HEAVY TRAFFIC, OR WITH HIGH SPEEDS, CONE SPACING MAY BE DOUBLED TO 80'.
2. REQUEST ADDITIONAL ASSISTANCE AND/OR TRAFFIC CONTROL DEVICES, IF NEEDED.



MA-W20-9



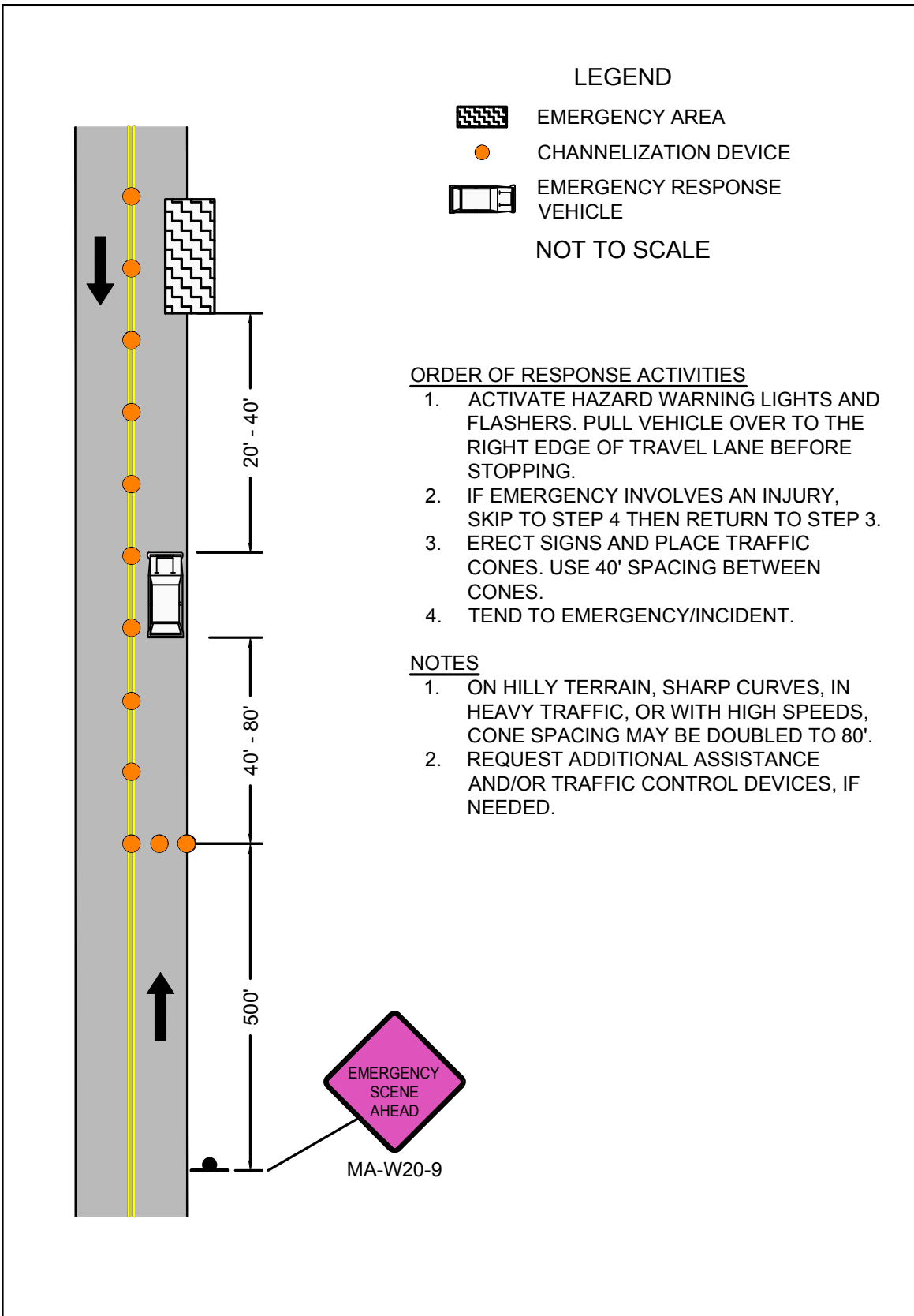





|  |   |  |
|--|---|--|
|  <p>Massachusetts Department of Transportation<br/>Highway Division</p> | <p>Work Zone Safety<br/>Standard Details<br/>and Drawings</p> | <p><b>FIGURE 34</b><br/>EMERGENCY RESPONSE<br/>TWO LANE ROADWAY<br/>NO SHOULDER<br/>TRAVEL LANE ENCROACHMENT</p> |
| <p>PAGE 67</p>   |   |  |

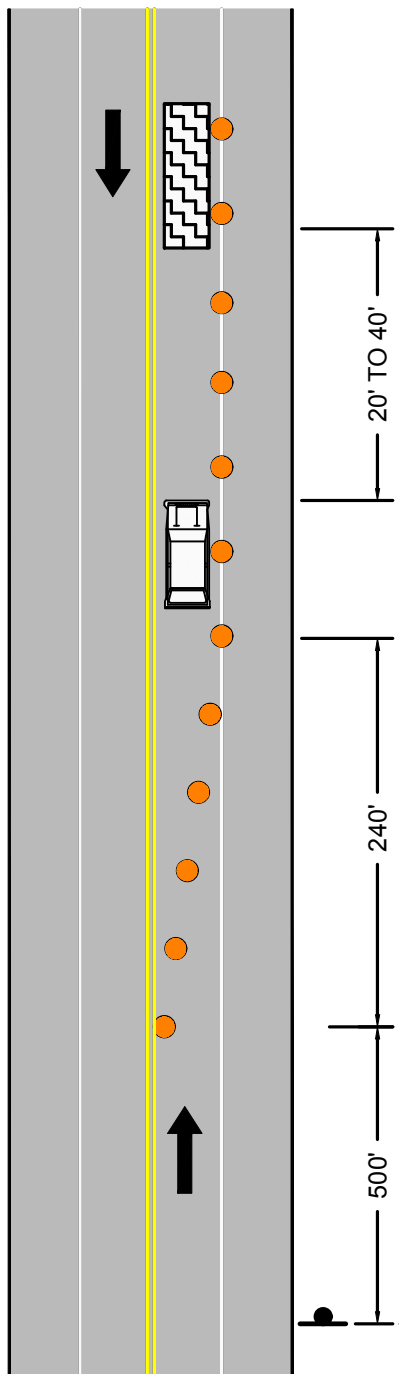

FIGURE 35  
EMERGENCY RESPONSE  
TWO LANE ROADWAY  
TRAVERSABLE SHOULDER  
SINGLE LANE ENCROACHMENT

LEGEND

-  EMERGENCY AREA
-  CHANNELIZATION DEVICE
-  EMERGENCY RESPONSE VEHICLE

NOT TO SCALE



ORDER OF RESPONSE ACTIVITIES

1. ACTIVATE HAZARD WARNING LIGHTS AND FLASHERS. PULL VEHICLE OVER TO THE LEFT EDGE OF TRAVEL LANE BEFORE STOPPING.
2. IF EMERGENCY INVOLVES AN INJURY, SKIP TO STEP 4 THEN RETURN TO STEP 3.
3. ERECT SIGNS AND PLACE TRAFFIC CONES. USE 40' SPACING BETWEEN CONES.
4. TEND TO EMERGENCY/INCIDENT.

NOTES

1. ON HILLY TERRAIN, SHARP CURVES, IN HEAVY TRAFFIC, OR WITH HIGH SPEEDS, CONE SPACING MAY BE DOUBLED TO 80'.
2. REQUEST ADDITIONAL ASSISTANCE AND/OR TRAFFIC CONTROL DEVICES, IF NEEDED.



MA-W20-9

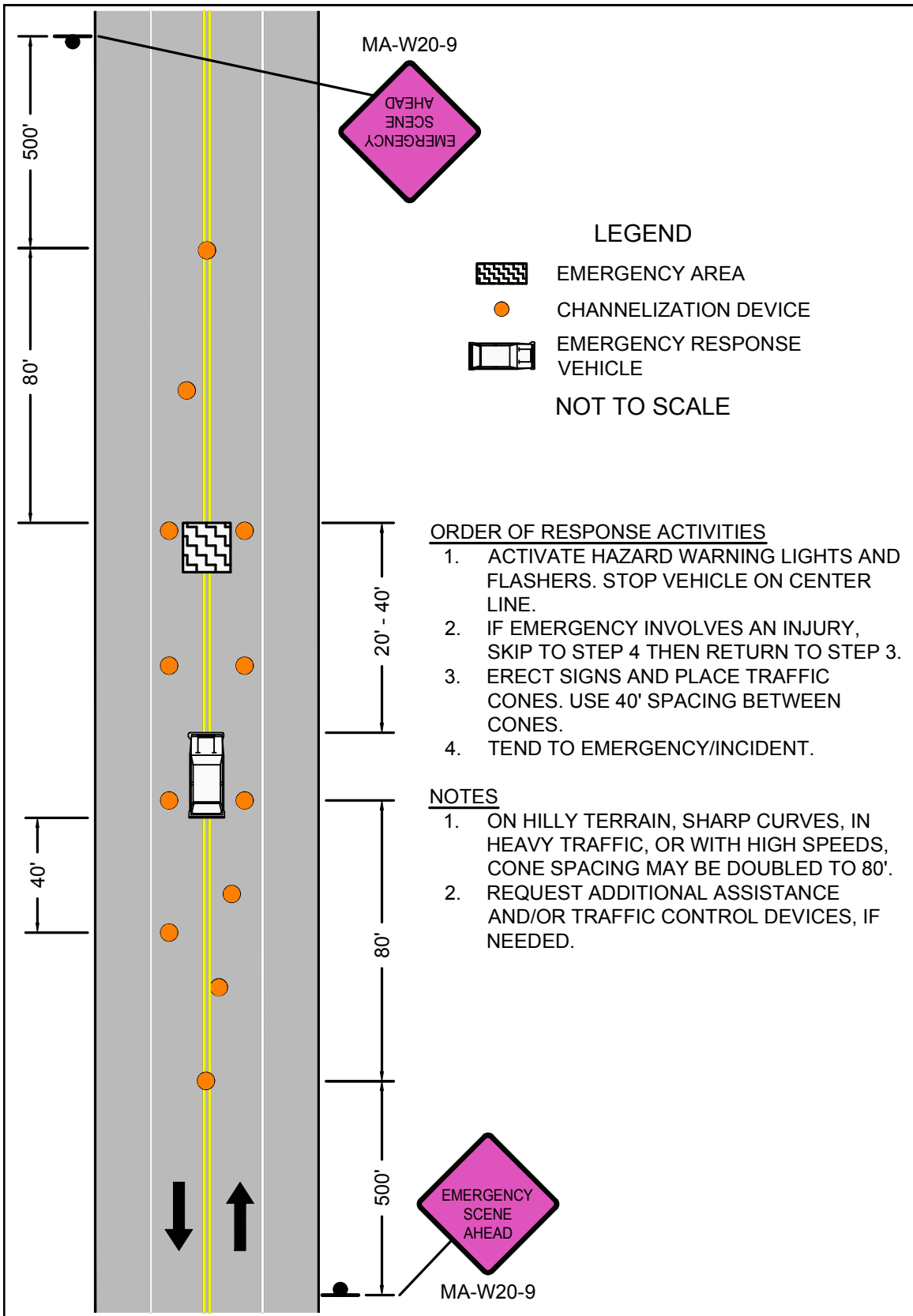
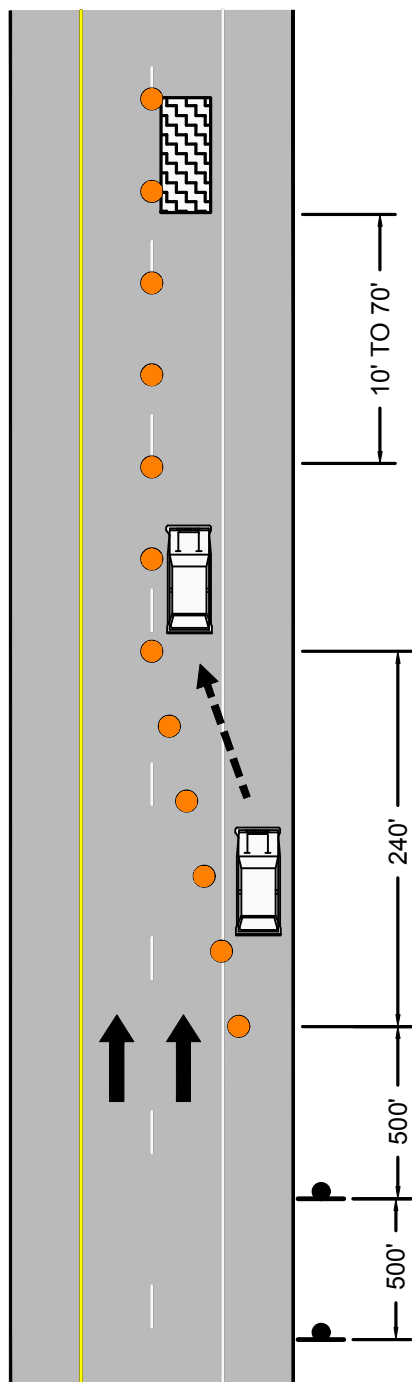







FIGURE 37  
EMERGENCY RESPONSE  
MULTILANE DIVIDED ROADWAY  
RIGHT LANE



LEGEND

-  EMERGENCY AREA
-  CHANNELIZATION DEVICE
-  EMERGENCY RESPONSE VEHICLE
-  RESPONSE VEHICLE MOVEMENT

NOT TO SCALE

ORDER OF RESPONSE ACTIVITIES

1. ACTIVATE HAZARD WARNING LIGHTS AND FLASHERS. STOP VEHICLE IN BREAKDOWN LANE.
2. IF EMERGENCY INVOLVES AN INJURY, SKIP TO STEP 6 THEN RETURN TO STEP 3.
3. ERECT SIGNS AND PLACE TRAFFIC CONES. USE 40' SPACING BETWEEN CONES.
4. MOVE RESPONSE VEHICLE BEHIND EMERGENCY.
5. PLACE ADDITIONAL CONES.
6. TEND TO EMERGENCY.

NOTES

1. ON HILLY TERRAIN, SHARP CURVES, IN HEAVY TRAFFIC, OR WITH HIGH SPEEDS, CONE SPACING MAY BE DOUBLED TO 80'.
2. REQUEST ADDITIONAL ASSISTANCE AND/OR TRAFFIC CONTROL DEVICES, IF NEEDED.

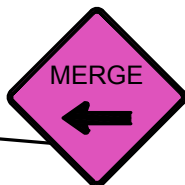

MA-W4-2aL

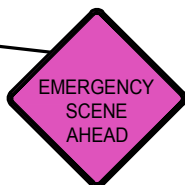

MA-W20-9

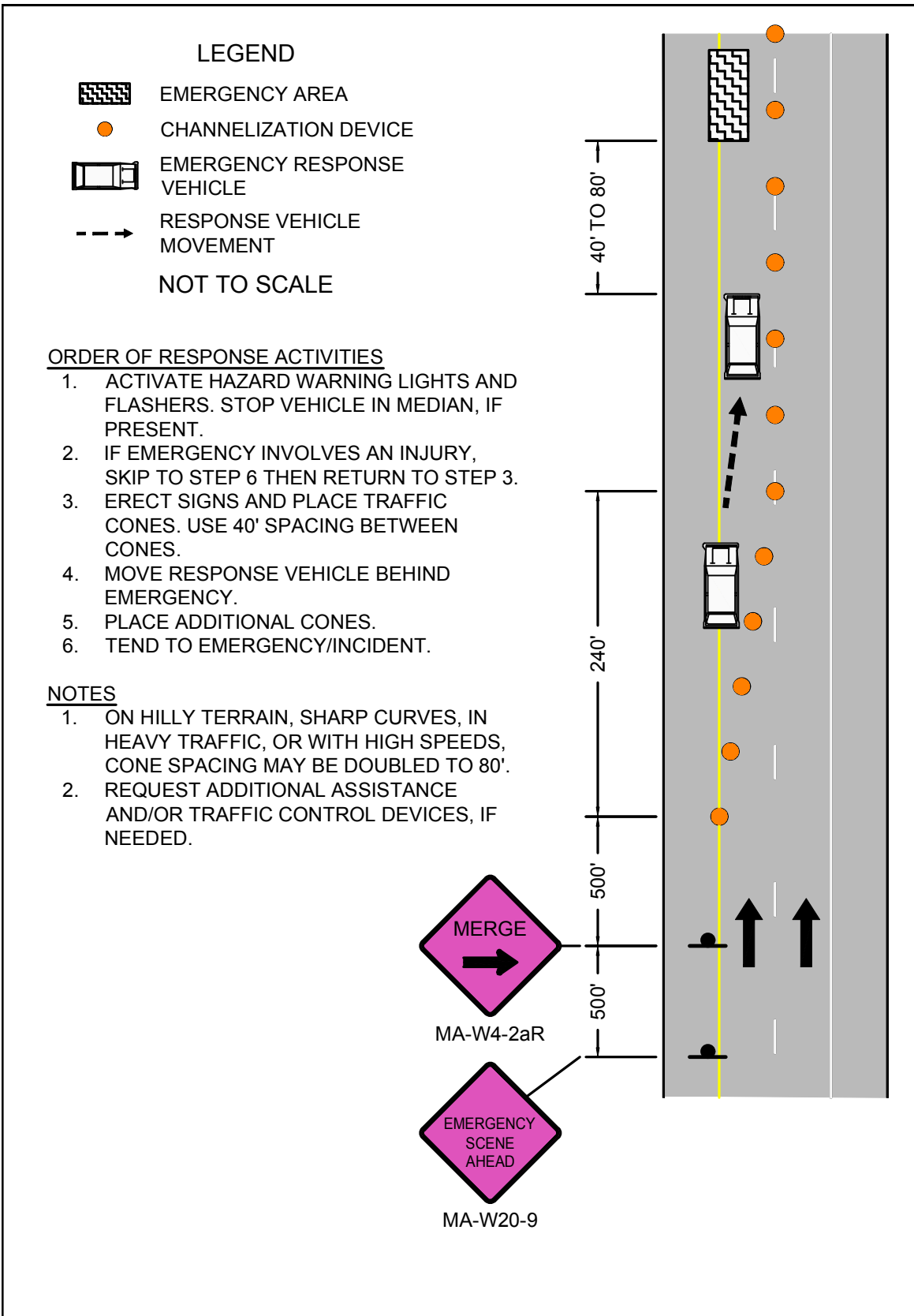
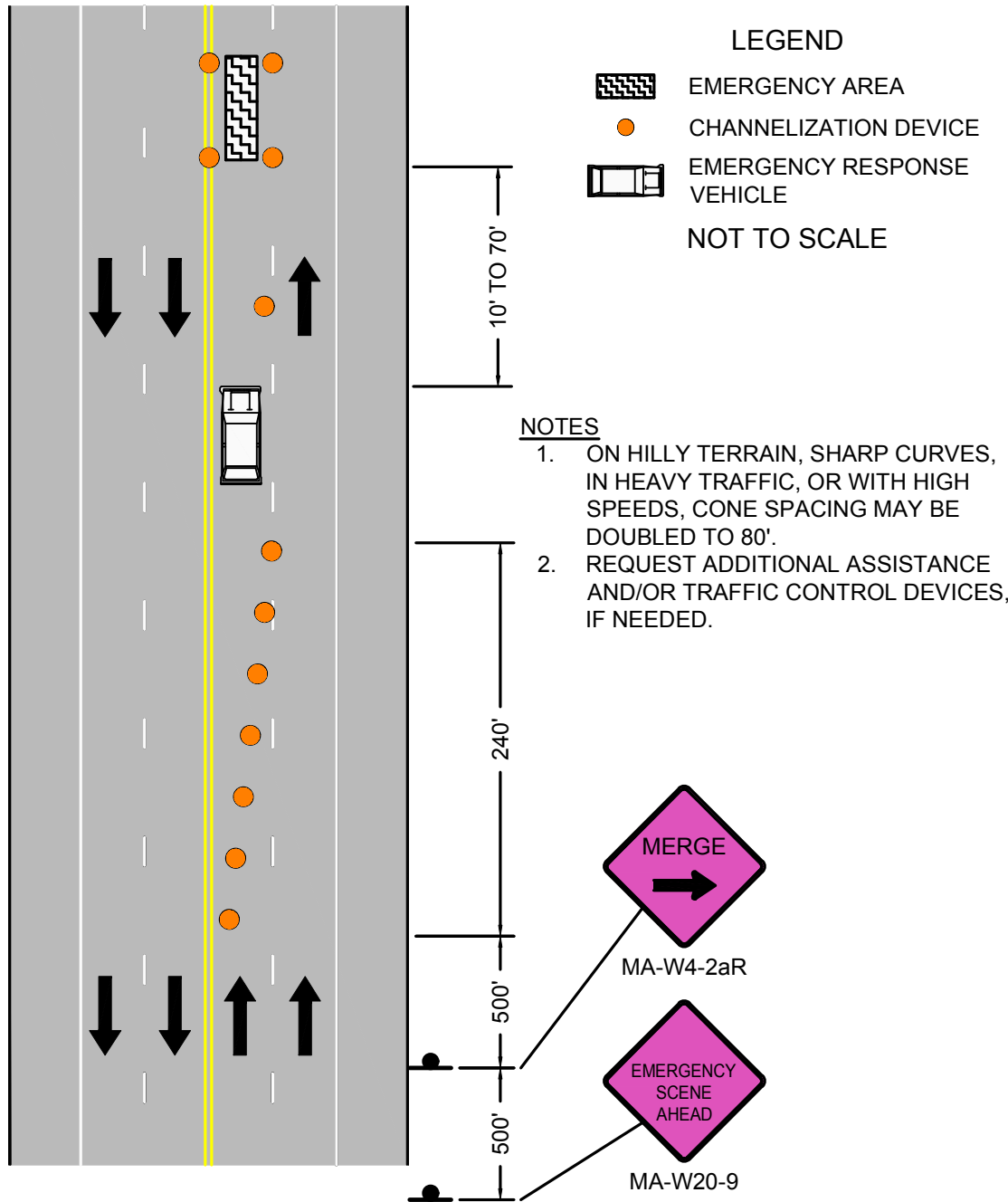

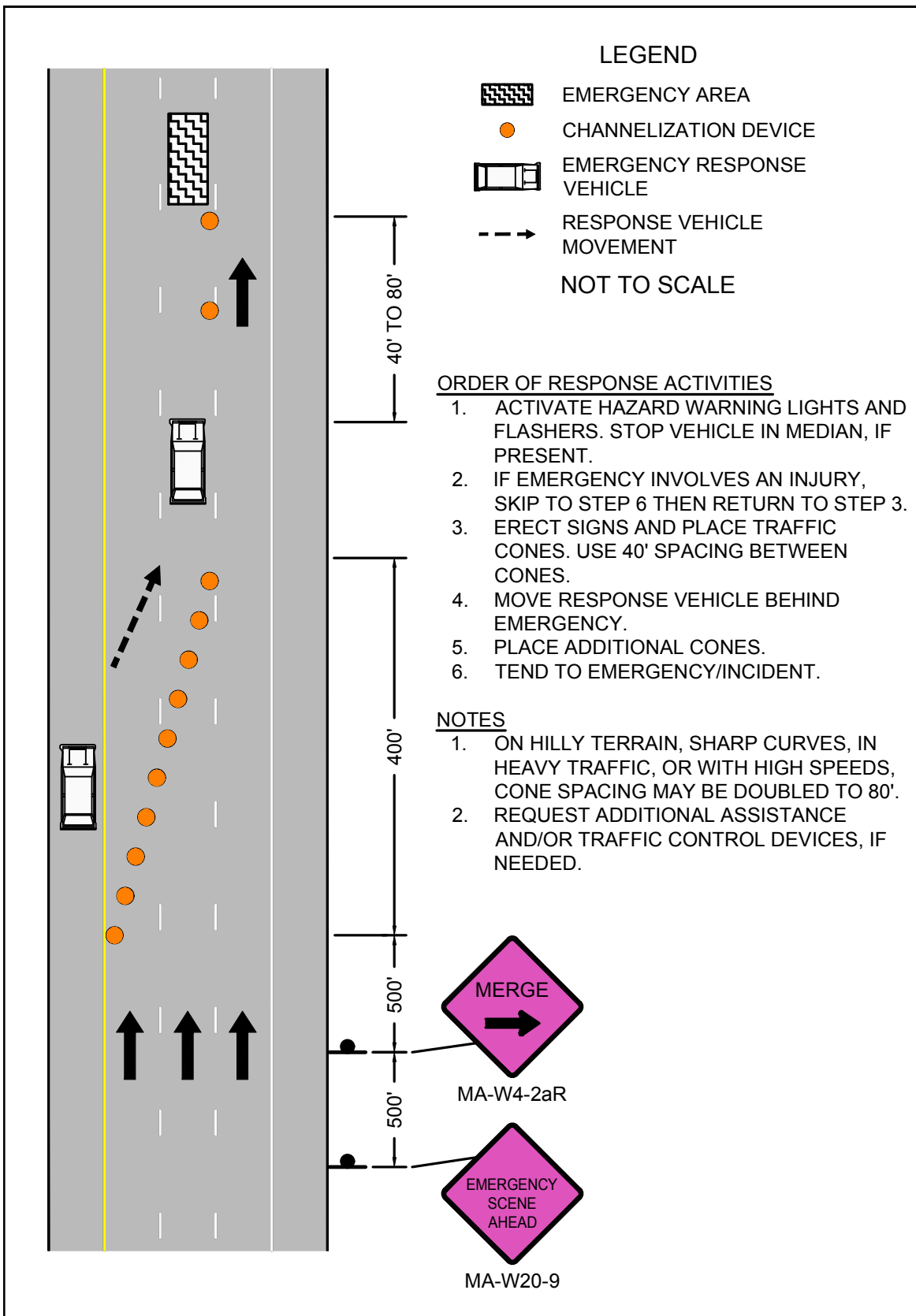

FIGURE 39  
EMERGENCY RESPONSE  
MULTILANE UNDIVIDED  
ROADWAY  
LEFT LANE



**ORDER OF RESPONSE ACTIVITIES**

1. ACTIVATE HAZARD WARNING LIGHTS AND FLASHERS. PULL VEHICLE OVER TO THE RIGHT EDGE OF BREAKDOWN LANE OR SHOULDER OR, IF NOT PRESENT, RIGHT EDGE OF TRAVEL LANE BEFORE STOPPING.
2. IF EMERGENCY INVOLVES AN INJURY, SKIP TO STEP 4 THEN RETURN TO STEP 3.
3. ERECT SIGNS AND PLACE TRAFFIC CONES. USE 40' SPACING BETWEEN CONES.
4. TEND TO EMERGENCY/INCIDENT.







|  |   |   |
|--|---|---|
|  <p>Massachusetts Department of Transportation<br/>Highway Division</p> | <p>Work Zone Safety<br/>Standard Details<br/>and Drawings</p> | <p><b>FIGURE 40</b><br/>EMERGENCY RESPONSE<br/>MULTILANE DIVIDED ROADWAY<br/>MIDDLE LANE<br/>APPROACH FROM LEFT</p> |
|--|---|---|



FIGURE 41  
EMERGENCY RESPONSE  
MULTILANE DIVIDED ROADWAY  
MIDDLE LANE  
APPROACH FROM RIGHT

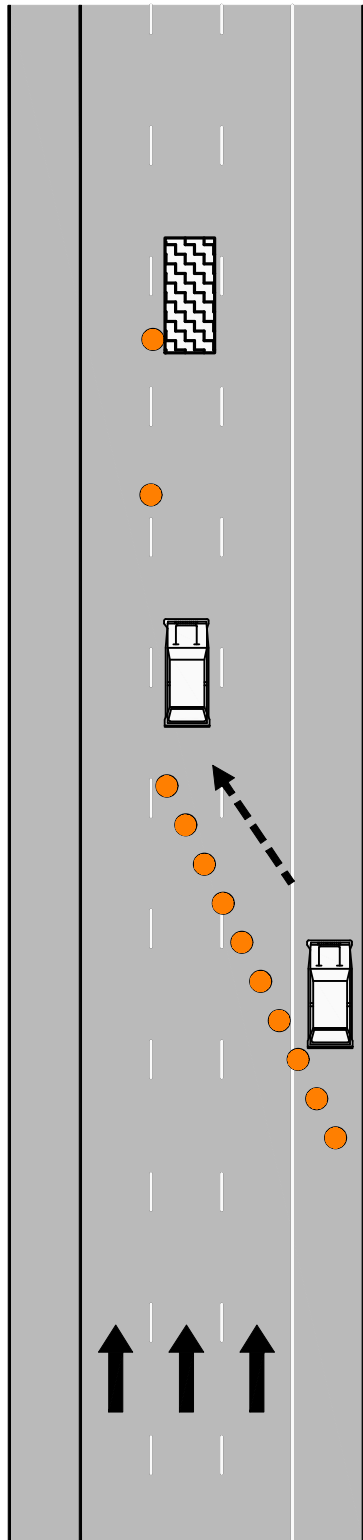

LEGEND

-  EMERGENCY AREA
-  CHANNELIZATION DEVICE
-  EMERGENCY RESPONSE VEHICLE
-  RESPONSE VEHICLE MOVEMENT

NOT TO SCALE

ORDER OF RESPONSE ACTIVITIES

1. ACTIVATE HAZARD WARNING LIGHTS AND FLASHERS. STOP VEHICLE IN BREAKDOWN LANE.
2. IF EMERGENCY INVOLVES AN INJURY, SKIP TO STEP 6 THEN RETURN TO STEP 3.
3. ERECT SIGNS AND PLACE TRAFFIC CONES. USE 40' SPACING BETWEEN CONES.
4. MOVE RESPONSE VEHICLE BEHIND EMERGENCY.
5. PLACE ADDITIONAL CONES.
6. TEND TO EMERGENCY.

NOTES

1. ON HILLY TERRAIN, SHARP CURVES, IN HEAVY TRAFFIC, OR WITH HIGH SPEEDS, CONE SPACING MAY BE DOUBLED TO 80'.
2. REQUEST ADDITIONAL ASSISTANCE AND/OR TRAFFIC CONTROL DEVICES, IF NEEDED.

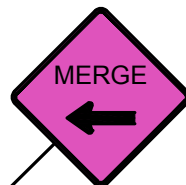

MA-W4-2aL



MA-W20-9



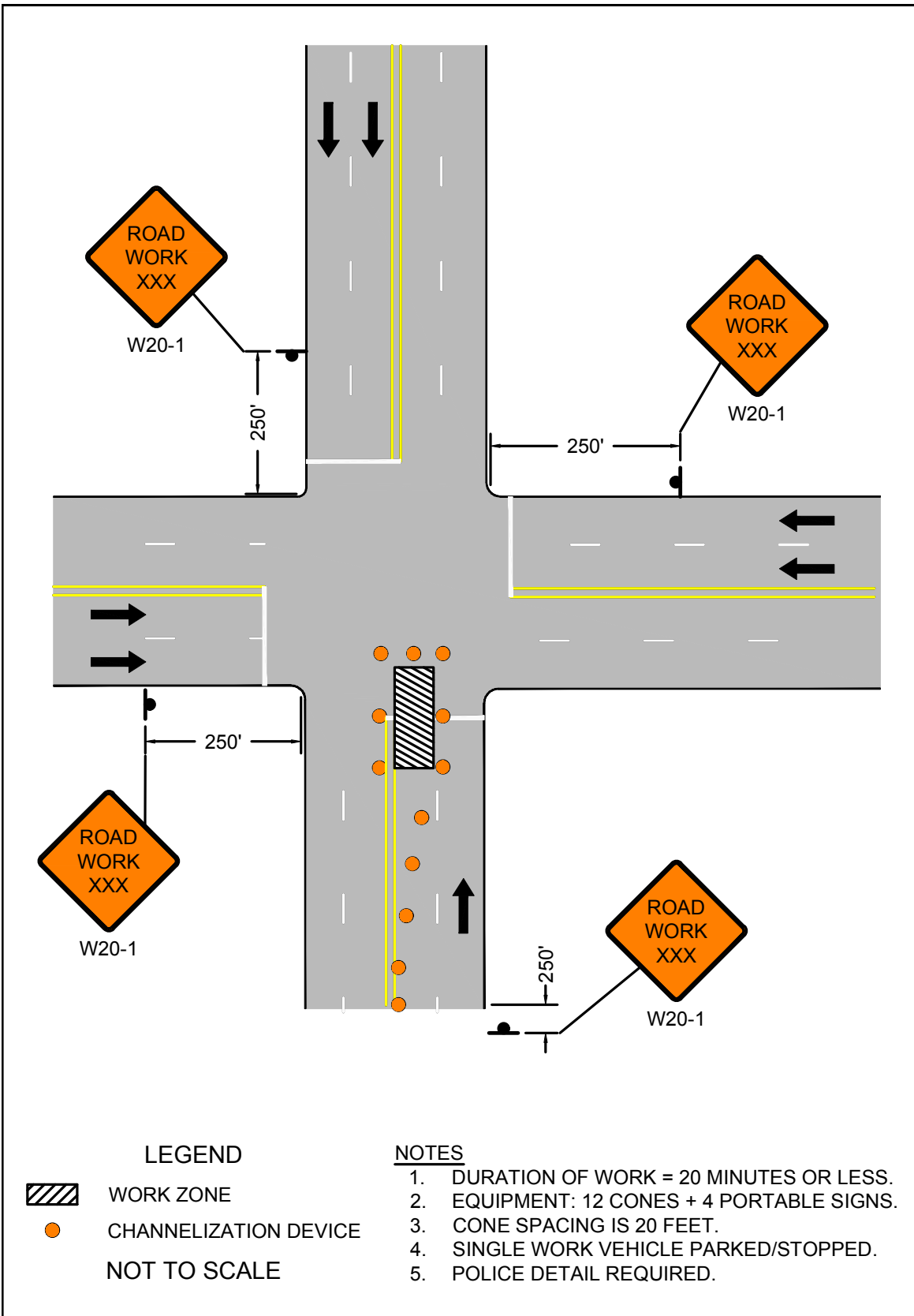
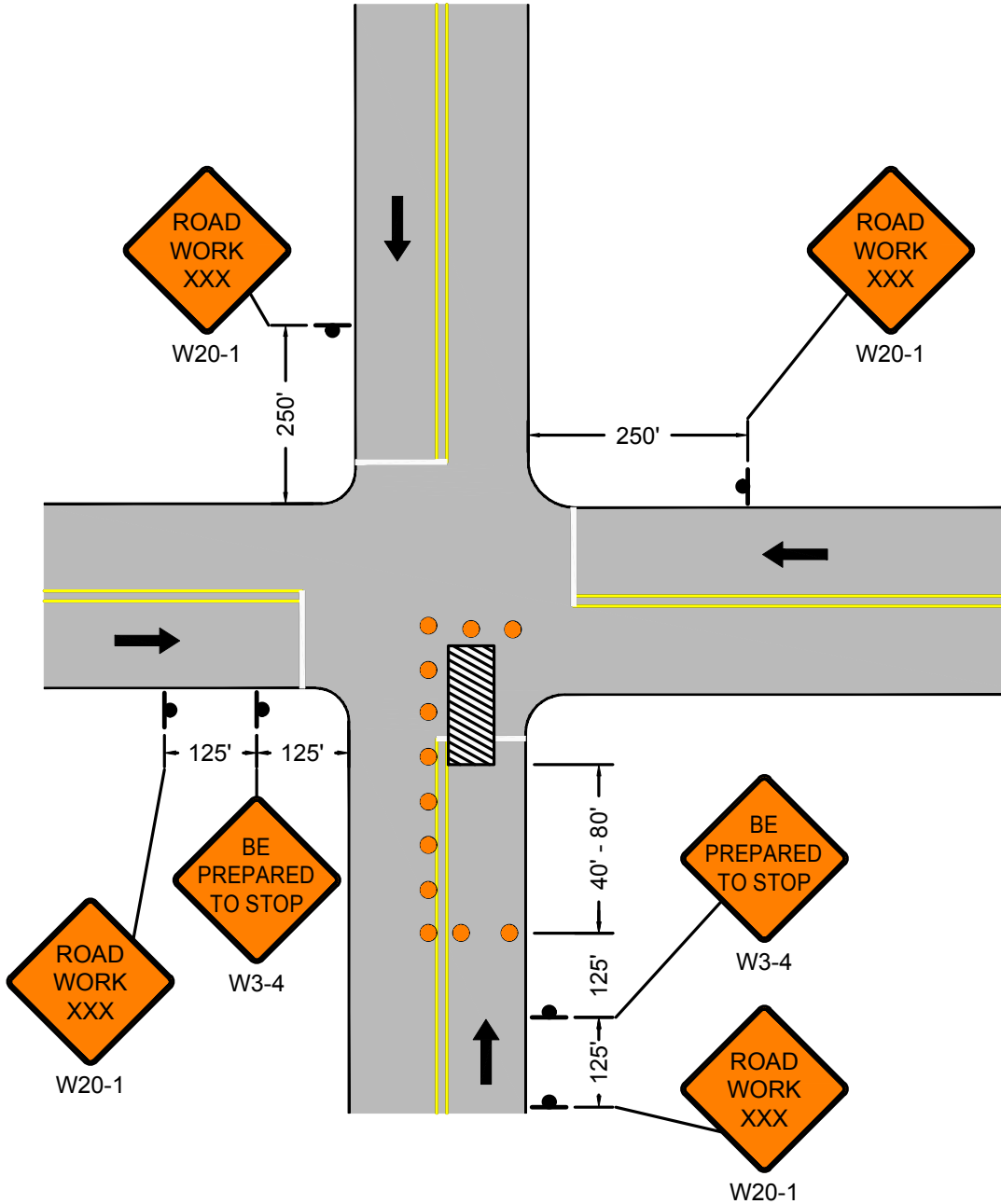





FIGURE 43  
TRAFFIC SIGNAL REPAIR WORK  
TWO LANE UNDIVIDED ROADWAY  
ONE LEG OF INTERSECTION



LEGEND

-  WORK ZONE
  -  CHANNELIZATION DEVICE
- NOT TO SCALE

NOTES

1. DURATION OF WORK = 20 MINUTES OR LESS.
2. EQUIPMENT: 12 CONES + 6 PORTABLE SIGNS.
3. CONE SPACING IS 20 FEET.
4. SINGLE WORK VEHICLE PARKED/STOPPED.
5. POLICE DETAIL REQUIRED.

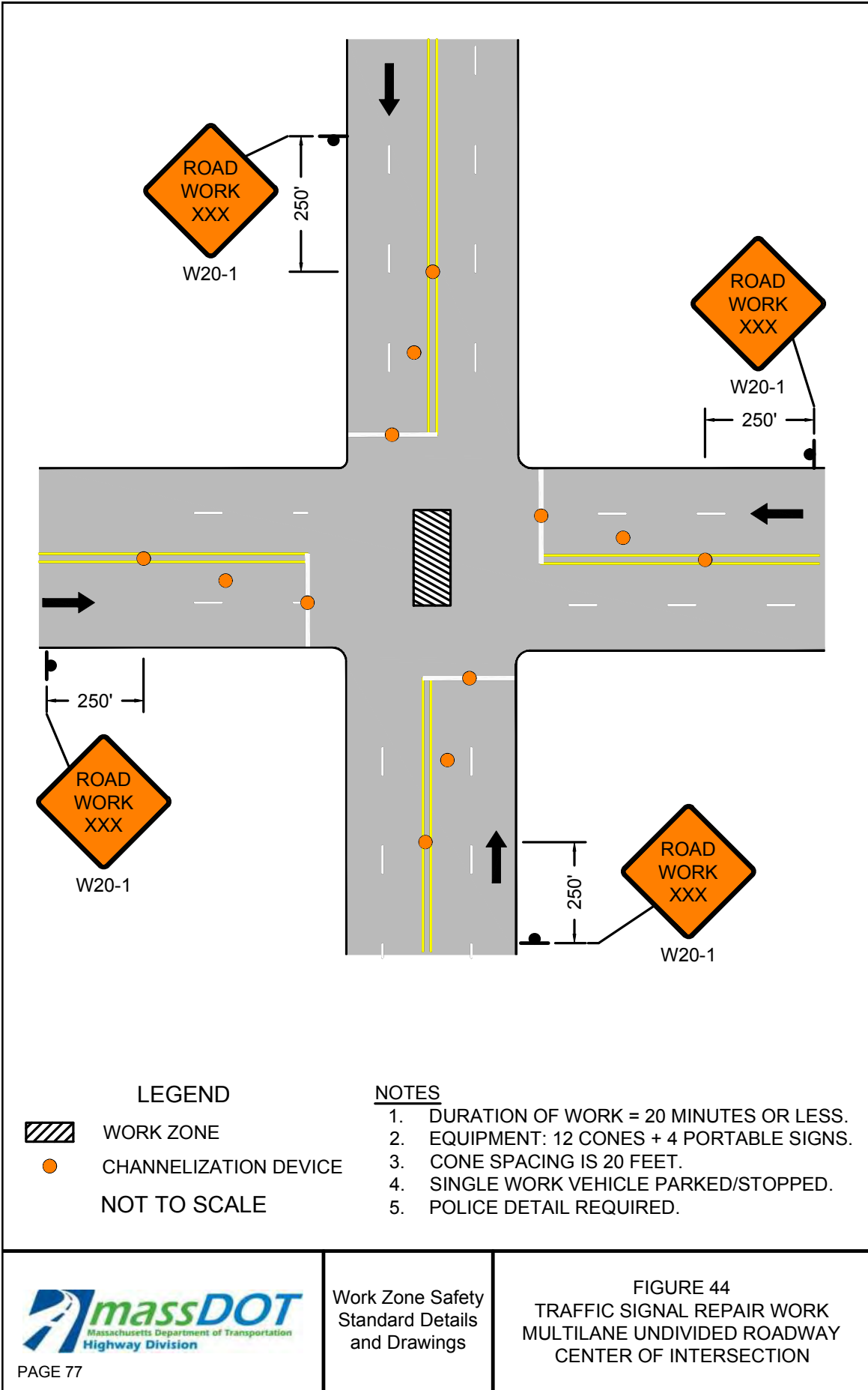
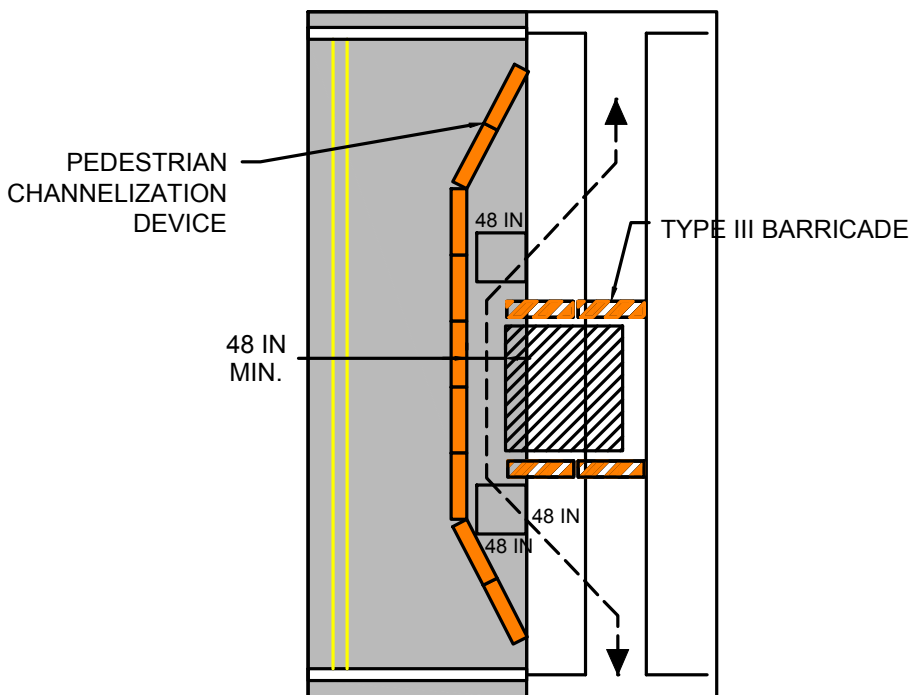

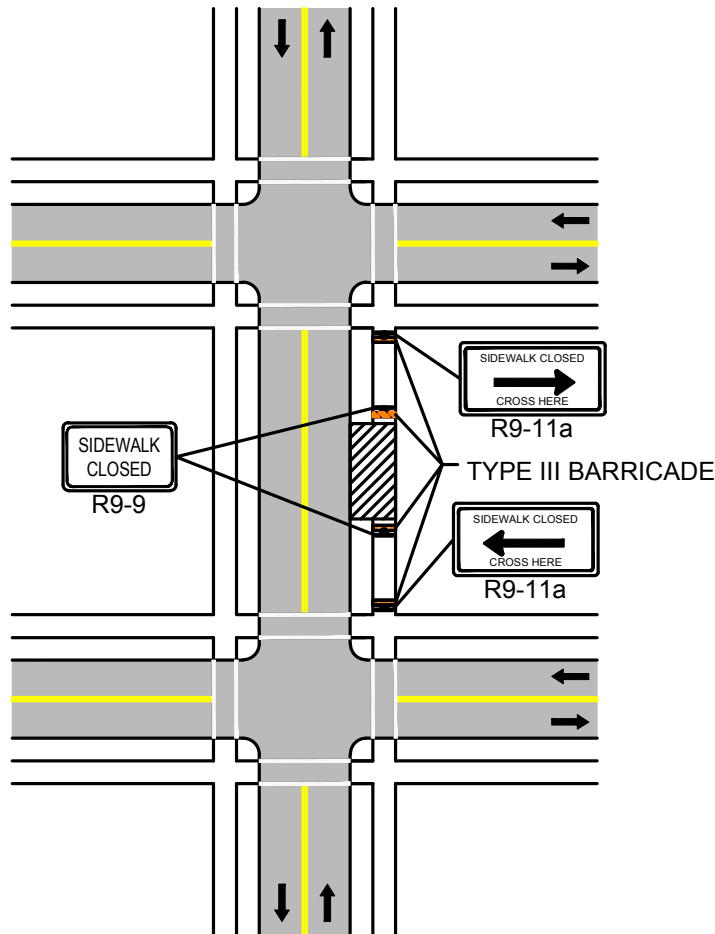

FIGURE 45  
PEDESTRIAN BYPASS



**NOTES:**

1. WHEN EXISTING PEDESTRIAN FACILITIES ARE DISRUPTED, CLOSED, OR RELOCATED IN A TTC ZONE, TEMPORARY FACILITIES SHALL BE PROVIDED AND THEY SHALL BE DETECTABLE AND INCLUDE ACCESSIBILITY FEATURES CONSISTENT WITH THE FEATURES PRESENT IN THE EXISTING PEDESTRIAN FACILITY.
2. A PEDESTRIAN CHANNELIZATION DEVICE THAT IS DETECTABLE BY A PERSON WITH A VISUAL DISABILITY TRAVELING WITH THE AID OF A LONG CANE SHALL BE PLACED ALONG THE FULL LENGTH OF THE TEMPORARY PEDESTRIAN ROUTE.
3. WHEN USED, TEMPORARY RAMPS SHALL COMPLY WITH AMERICANS WITH DISABILITIES ACT.
4. THE ALTERNATE PATHWAY SHOULD HAVE A SMOOTH CONTINUOUS HARD SURFACE FOR THE ENTIRE LENGTH OF THE TEMPORARY PEDESTRIAN FACILITY.
5. THE TEMPORARY SIDEWALK SHOULD BE A MINIMUM OF 4 FEET WIDE. IF THE SIDEWALK EXCEEDS 200 FEET THEN A 5 FOOT BY 5 FOOT PASSING ZONE SHALL BE PROVIDED NEAR THE MID-POINT OF THE CLOSURE.
6. THE PROTECTIVE REQUIREMENTS OF A TTC WORK ZONE MAY HAVE AN IMPACT IN DETERMINING THE NEED FOR TEMPORARY TRAFFIC BARRIERS AND THEIR USE IN PROVIDING PEDESTRIAN DELINEATION SHOULD BE BASED ON ENGINEERING JUDGMENT.
7. ON-DEMAND PEDESTRIAN ASSISTANCE PERSONNEL TO ASSIST WITH NAVIGATION AROUND THE CLOSURE/WORK AREA MAY BE CONSIDERED AS AN OPTION IN PLACE OF PROVIDING ADA/AAB DEVICES FOR WORK FOR CLOSURES LASTING 4 HOURS OR LESS.
8. CONTROLS ONLY FOR PEDESTRIAN TRAFFIC ARE SHOWN; VEHICULAR TRAFFIC SHOULD BE HANDLED AS SHOWN ELSEWHERE. THESE DETAILS ARE USED IN CONJUNCTION WITH THE PROPOSED LANE CLOSURE DETAILS AND DURING CONSTRUCTION STAGING, AS DETERMINED BY THE ENGINEER.



**NOTES:**

1. CLOSURE OF A SIDEWALK FACILITY SHALL CONSTITUTE THE PROVISION FOR MANAGING PEDESTRIAN TRAFFIC AND ACCOMMODATING ALL USERS. IF THE EXISTING PEDESTRIAN ACCESS ROUTE(S) CAN BE TEMPORARILY RELOCATED ALONG THE EXISTING SIDEWALK , AND SAID FACILITY PROVIDES A MINIMUM WIDTH OF 48-INCHES OF SOLID, SMOOTH UNOBSTRUCTED SURFACE, THEN NO DETOURING OF THE ROUTE SHALL BE REQUIRED. DELINEATION OF THE WORK AREA IS STILL REQUIRED.
2. IF IT IS NECESSARY TO DIVERT PEDESTRIAN TRAFFIC TO AN ALTERNATE ROUTE ACROSS THE ROADWAY FROM THE EXISTING FACILITY, THE FIGURE ABOVE SHALL BE FOLLOWED TO PROVIDE ADEQUATE DIRECTION TO PEDESTRIANS. ALTERNATE ROUTE SHALL PROVIDE THE SAME LEVEL OF ACCOMMODATION AS THE FACILITY THAT IS BEING DETOURED AND RETAIN ADA COMPLIANCE IN ITS ENTIRETY.
3. FOR EMERGENCY OR SHORT-DURATION SIDEWALK CLOSURES OF 4-HOURS OR LESS, IT IS OPTIONAL TO HAVE ON-DEMAND PEDESTRIAN ASSISTANCE PERSONNEL AVAILABLE AT ALL TIMES DURING THE CLOSURE TO ASSIST THOSE MOBILITY CHALLENGED PERSONS WHO REQUIRE ADDITIONAL ASSISTANCE TO SAFELY NAVIGATE AROUND THE WORK AREA IN LIEU OF A FULL DETOUR.





PAGE 80

Work Zone Safety  
Standard Details  
and Drawings

STATIONARY OPERATIONS  
BIKE LANE CLOSURE









| POSTED SPEED LIMIT (MPH) | SPACING FOR BIKE ADVANCE WARNING SIGNS (FT) (A,B)) | CHANNELIZATION DEVICES (DRUMS OR CONES) |                         |                     |                   |
|--------------------------|--|---|-------------------------|---------------------|-------------------|
|                          |  | TRANSITION LENGTH (L/3)                 | BUFFER ZONE LENGTH (FT) | DEVICE SPACING (FT) | MIN # OF DEVICES* |
| 25-40                    | 150 / 150  | 100                                     | 305                     | 20                  | 45                |
| 45-55                    | 150 / 150  | 220                                     | 495                     | 40                  | 35                |
| 60-65                    | 150 / 150  | 260                                     | 645                     | 40                  | 40                |

\* NUMBER OF DEVICES BASED ON 400 FT WORK ZONE.

**NOTES**

1. DETAIL SHALL BE USED IN CONJUNCTION WITH THE PROPOSED LANE CLOSURE DETAILS. SIGNING SHOWN ONLY FOR BIKE TRAFFIC. FOLLOW ALL OTHER RELEVANT DETAILS FOR TTC DEVICES FOR VEHICULAR TRAFFIC.
2. **\*\*** SIGN SHALL BE USED ONLY IF THERE IS A MARKED BIKE LANE.
3. **\*\*\*** SIGN SHALL BE USED ONLY IF THERE IS NO MARKED BIKE LANE.

**LEGEND**

-  WORK ZONE
-  CHANNELIZATION DEVICE
-  FLASHING ARROW BOARD
-  PORTABLE CHANGEABLE MESSAGE SIGN
-  TRUCK MOUNTED ATTENUATOR
-  RADAR SPEED FEEDBACK BOARD
-  POLICE DETAIL OR UNIFORMED FLAGGER
-  TEMPORARY PORTABLE RUMBLE STRIP
-  TYPE III BARRICADE

NOT TO SCALE

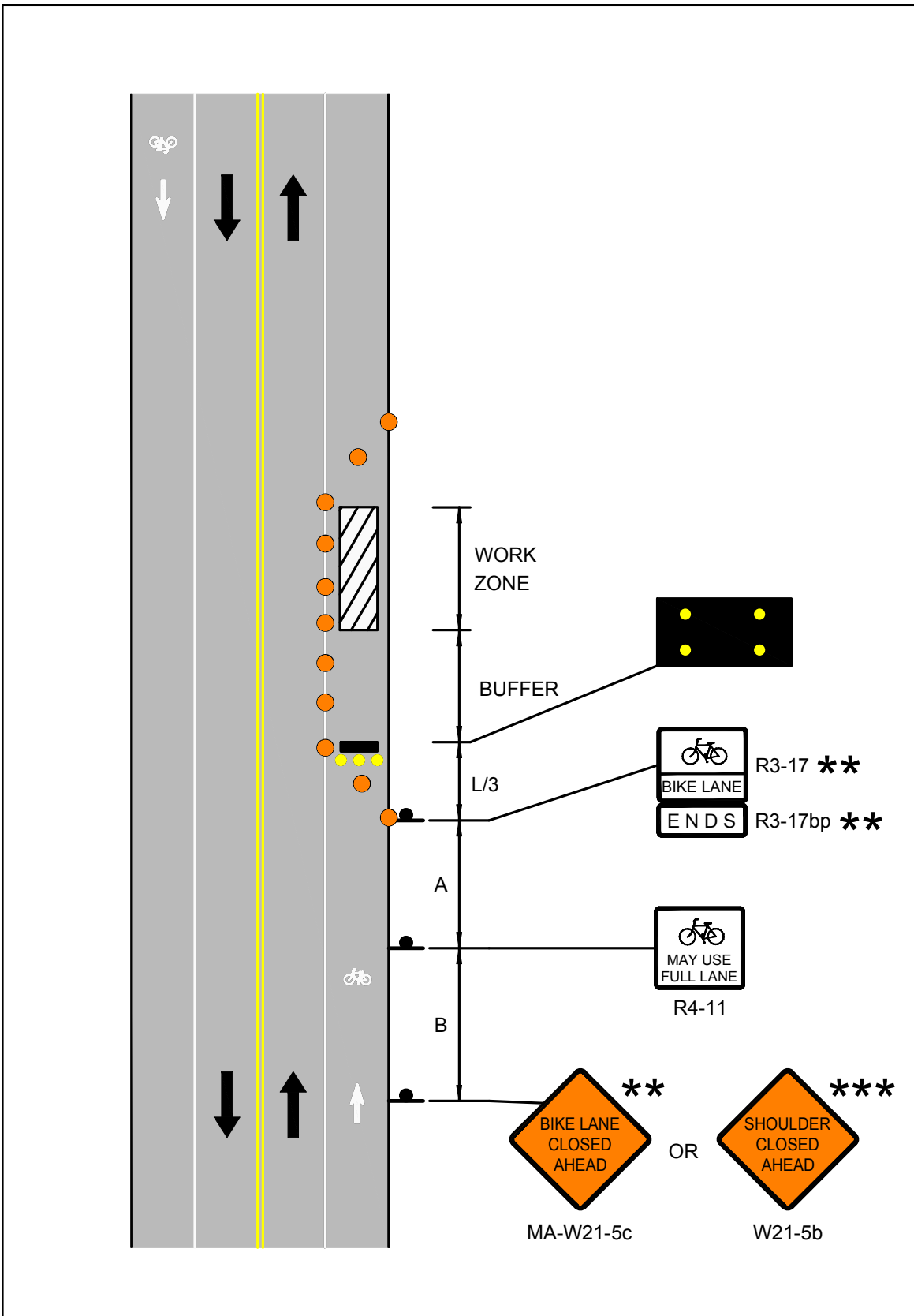

|   |   |  |
|---|---|--|
|  <p>Massachusetts Department of Transportation<br/>Highway Division</p> <p>PAGE 81</p> | <p>Work Zone Safety<br/>Standard Details<br/>and Drawings</p> | <p>FIGURE 48<br/>STATIONARY OPERATIONS<br/>BIKE LANE CLOSURE</p> |
|---|---|--|



**Safety is everyone's business**

Rev. June, 2017



DOCUMENT A00820

**Massachusetts Department of Transportation  
Conditions of Custody**

REQUEST FOR RELEASE OF MASSDOT AUTOCAD FILES FORM

(Only to be used following award of contract)

Contract Number: 124171 Project File Number: 607680

City/Town: Fitchburg

Project Description: Bridge Rehabilitation, F-04-010, River Street (ST 31) over North Nashua River

All AutoCAD files are provided solely as a courtesy to facilitate public access to information. MassDOT attempts to provide current and accurate information but cannot guarantee so. MassDOT provides such documents, files or other data "as is" without any warranty of any kind, either expressed or implied, including but not limited to, accuracy, reliability, omissions, completeness and currentness. The Commonwealth of Massachusetts and its Consultants shall not be liable for any claim for damages, including lost profits or other consequential, exemplary, incidental, indirect or special damages, relating in any way to the documents, files or other data accessible from this file, including, but not limited to, claims arising out of or related to electronic access or transmission of data or viruses. Because data stored on electronic media can deteriorate undetected or be modified without our knowledge, MassDOT cannot be held liable for its completeness or correctness. MassDOT makes no representation as to the compatibility of these files beyond the version of the stated CAD software.

By signing this form, I agree that it shall be my responsibility to reconcile this electronic data with the conformed contract documents, and that only the conformed contract documents shall be regarded as legal documents for this Project. I understand that this authorization does not give me the right to distribute the files. I agree to the terms above and wish to receive the AutoCAD files.

This signed form shall be emailed to the Highway Design Engineer at the MassDOT -Highway Division at the following email address:

[DOTHighwayDesign@dot.state.ma.us](mailto:DOTHighwayDesign@dot.state.ma.us)

Attn: AutoCAD Files

Name of person requesting AutoCAD files: \_\_\_\_\_

Affiliation/Company: \_\_\_\_\_

Address: \_\_\_\_\_

Telephone number: \_\_\_\_\_

Email address: \_\_\_\_\_

Signature/Date: \_\_\_\_\_

THIS PAGE INTENTIONALLY LEFT BLANK

DOCUMENT A00830

**ARMY CORPS OF ENGINEERS**

**SELF-VERIFICATION NOTIFICATION**

THIS PAGE INTENTIONALLY LEFT BLANK

**U.S. Army Corps of Engineers (USACE)  
SELF-VERIFICATION NOTIFICATION (SVN)**

**DATA REQUIRED BY THE PRIVACY ACT OF 1974**

**Authority** Rivers and Harbors Act, Section 10, 33 USC 403; Clean Water Act, Section 404, 33 USC 1344; Regulatory Programs of the Corps of Engineers; Final Rule 33 CFR 320-332.

**Principal Purpose** This information will be used in evaluating activities under Self-Verification procedures within Massachusetts.

**Routine Uses** Routine uses will include: (1) Documenting compliance with the terms and conditions of the General Permit (GP) for activities that may require authorization pursuant to one or more of USACE's Regulatory authorities. (2) Records may be referred to other Federal, State, and local agencies for evaluation and enforcement purposes.

**Disclosure** Failure to fully comply and abide by the GP terms and conditions prior to commencing work and after completion project may result in formal enforcement action, up to and including monetary penalties and/or legal action, pursuant to 33 CFR Part 326.

**Instructions** The permittee must complete ALL required sections of this document before commencing USACE-regulated activities. A copy of this completed SVN must be kept on site during construction and be made available for review by USACE and other Federal, State, & Local regulatory authorities at any time. Within 30 days of initiating project construction, the permittee shall submit the completed SVN to USACE. The SVN shall be submitted to USACE as **ONE signed document** that includes project plans and documentation that supports each field (e.g., emails, letters, description, phone calls, surveys). Electronic submissions to the following address are strongly preferred: [cenae-r-ma-sv@usace.army.mil](mailto:cenae-r-ma-sv@usace.army.mil). The email subject line shall contain the following: GP #, SVN, City/Town, and date submitted.

**(ITEMS 1 THRU 3 TO BE FILLED BY USACE)**

|                    |                      |                  |
|--------------------|----------------------|------------------|
| 1. APPLICATION NO. | 2. FIELD OFFICE CODE | 3. DATE RECEIVED |
|--------------------|----------------------|------------------|

**APPLICANT AND AGENT INFORMATION**

|  |  |
|--|--|
| <p>4. APPLICANT'S NAME<br/>                 First - Courtney Middle - Walker Last - Walker<br/>                 Company - MA Department of Transportation - Highway Division<br/>                 E-mail Address - courtney.l.walker@dot.state.ma.us</p> | <p>7. AGENT'S ADDRESS:<br/>                 First - Gregory Middle - Russo Last - Russo<br/>                 Company - TRC<br/>                 E-mail Address - grusso@trccompanies.com</p> |
| <p>5. APPLICANT'S ADDRESS:<br/>                 Address- 10 Park Plaza, Room 7360<br/>                 City - Boston State - MA Zip - 02116 Country - USA</p>  | <p>8. AGENT'S ADDRESS:<br/>                 Address- 650 Suffolk Street, Suite 200<br/>                 City - Lowell State - MA Zip - 0185 Country - U</p>                                  |
| <p>6. APPLICANT'S PHONE NOs. w/AREA CODE<br/>                 a. Residence b. Business c. Fax<br/>                 857-262-0757</p>  | <p>9. AGENTS PHONE NOs. w/AREA CODE<br/>                 a. Residence b. Business c. Fax<br/>                 978-941-58</p>   |

**NAME, LOCATION, AND DESCRIPTION OF PROJECT SITE**

|   |   |
|---|---|
| 10. PROJECT NAME OR TITLE<br>River Street Bridge Replacemet                                       |   |
| 11. FILE NUMBER(S) OF PREVIOUS USACE ACTIONS ON THE SITE (if applicable)                          | 12. NAME OF WATERBODY<br>North Nashua River   |
| 13. PROJECT COORDINATES (in decimal degrees)<br>Latitude: °N 42.587029° Longitude: °W -71.808612° | 14. PROJECT STREET ADDRESS (if applicable)<br>Address 0 Main St.<br>City - Fitchburg State - MA Zip - 01420 |

**ACTIVITY TYPE, PROJECT IMPACTS, AVOIDANCE & MINIMIZATION**

15. GENERAL PERMIT ACTIVITIES (CHECK ALL THAT APPLY)

|                                       |                                       |                             |                             |                             |
|---------------------------------------|---------------------------------------|-----------------------------|-----------------------------|-----------------------------|
| 1 <input type="checkbox"/>            | 6 <input checked="" type="checkbox"/> | 11 <input type="checkbox"/> | 16 <input type="checkbox"/> | 21 <input type="checkbox"/> |
| 2 <input checked="" type="checkbox"/> | 7 <input type="checkbox"/>            | 12 <input type="checkbox"/> | 17 <input type="checkbox"/> | 22 <input type="checkbox"/> |
| 3 <input type="checkbox"/>            | 8 <input type="checkbox"/>            | 13 <input type="checkbox"/> | 18 <input type="checkbox"/> | 23 <input type="checkbox"/> |
| 4 <input type="checkbox"/>            | 9 <input type="checkbox"/>            | 14 <input type="checkbox"/> | 19 <input type="checkbox"/> | 24 <input type="checkbox"/> |
| 5 <input type="checkbox"/>            | 10 <input type="checkbox"/>           | 15 <input type="checkbox"/> | 20 <input type="checkbox"/> | 25 <input type="checkbox"/> |

16. SUMMARY OF PROJECT IMPACTS (see instructions)

| Area (square feet) | Length (linear feet) | Volume (cubic yards) | Duration |
|--------------------|----------------------|----------------------|----------|
| 150temporary       | 37 temporary         |                      | 15 days  |
|                    |                      |                      |          |
|                    |                      |                      |          |
|                    |                      |                      |          |

|  |  |
|--|--|
| <p>17. PROJECT PLANS (BY CHECKING THE BOXES BELOW, YOU CERTIFY THESE ITEMS ARE COMPLETE) (<i>see instructions</i>)</p> <p><input checked="" type="checkbox"/> a. Plans shall at least contain the following: Vicinity Map, Plan View, and Typical Cross Section View of the proposed activity.</p> <p><input checked="" type="checkbox"/> b. All direct, indirect and secondary impacts from USACE regulated activities are shown on the project plans.</p> <p><input checked="" type="checkbox"/> c. The size of the impact area for each activity (acre, square feet, linear feet) are shown on the project plans.</p> <p><input type="checkbox"/> d. For discharges of fill material (§404), the volume of fill material is identified on the project plans.</p> <p><input type="checkbox"/> e. The duration of each impact, permanent or temporary (X days), is identified on the project plans.</p> <p><input type="checkbox"/> f. Do activities with permanent impacts result in the loss of waters? If so, this is identified on the project plans.</p> <p><input checked="" type="checkbox"/> g. All aquatic resources in the vicinity of the USACE regulated activities are delineated on the project plans.</p>  |  |
| <p>18. AVOIDANCE &amp; MINIMIZATION (BY CHECKING THE BOXES BELOW, YOU CERTIFY THESE CRITERIA ARE MET) (<i>see instructions</i>)</p> <p><input checked="" type="checkbox"/> a. The project has been designed to avoid and minimize impacts to aquatic resources.</p> <p><input checked="" type="checkbox"/> b. The footprint of activities in waters of the U.S. has been reduced to only what is necessary to achieve the overall project purpose.</p> <p><input checked="" type="checkbox"/> c. All practicable measures have been taken to avoid and minimize impacts to aquatic resources through construction techniques and site access (e.g., Best Management Practices, Time of Year Restrictions).</p> <p><input checked="" type="checkbox"/> d. All temporary impacts from USACE regulated activities will be restored upon completion of construction and the project area will be returned to pre-construction contours and conditions.</p>   |  |
| <p><b>COMPLIANCE WITH FEDERAL REGULATIONS &amp; SUPPLEMENTAL INFORMATION</b></p>   |  |
| <p>19. DUE DILIGENCE (<i>see instructions</i>)</p> <p>Complete the entries below to document compliance with the following Federal requirements. Construction may NOT begin if a PCN is/may be required, and you must contact USACE to determine permitting requirements. Documentation that demonstrates how the activity complies with each field below shall be submitted to the USACE as noted in the instructions block. See each General Condition (GC) in the GP for how to comply with each requirement.</p> <p>a. State Historic Preservation Officer      Per Appendix A, the activity has no potential to affect historic properties.</p> <p>b. Massachusetts BUAR                              Per Appendix A, the activity has no potential to affect historic properties.</p> <p>c. Tribal Historic Preservation Officers      The Tribe(s) were notified and they didn't respond with concerns within 30 days.</p> <p>d. Endangered Species Act - NOAA              Another Federal agency has reached a no effect determination.</p> <p>e. Endangered Species Act - USFWS              Another Federal action agency reached a no effect determination.</p> <p>f. Northern Long Eared Bat (ESA)              No effect determination reached with the Rangewide D-Key. See Instructions below.*</p> <p>g. Essential Fish Habitat                              The activity fully complies with GC 11.</p> <p>h. Wild &amp; Scenic Rivers                              There are no WSR's within 0.25 miles of the project area.</p> <p>i. 401 Water Quality Certification 401              The activity qualifies under the general 401 WQC for the 2023 MA GPs. <span style="float: right;"><input type="button" value="v"/></span></p> <p style="margin-left: 40px;">401 WQC/OOC File Number:                              OOC issued:                              401 issued:</p> <p>j. Section 408 Permission                              Not Required per GC 15a-f, no Federal Projects are within the project vicinity.</p> <p>k. Coastal Zone    The project is not located within the coastal zone.</p> <p>l. Construction Mats                                      N/A, the activity does not require the installation of construction mats.</p> <p>m. Time of Year Restrictions                              N/A, the project is not located in a waterbody that has TOY restrictions.</p> <p>n. Vernal Pools    Per GC 28, the project is not located in a vernal pool.</p> <p>o. Sediment &amp; Erosion Controls                      Per GC 25, the activity uses BMPs to avoid/minimize sedimentation &amp; erosion.</p> <p>p. Stream/Wetland Crossings                              The activity does not require a stream/wetland crossing.</p> |  |
| <p>20. AQUACULTURE ACTIVITIES - GP 18 (<i>see instructions</i>)</p> <p><input type="checkbox"/> a. If required, an Aquaculture Certification from the Massachusetts Division of Marine Fisheries was obtained prior to commencing work.</p> <p><input type="checkbox"/> b. Coordination with the U.S. Coast Guard pursuant to Private Aids to Navigation has occurred prior to commencing work.</p> <p><input type="checkbox"/> c. If required, a MEPA Certificate was obtained from the Massachusetts Environmental Protection Agency prior to commencing work. <b>Select Option</b></p> <p><input type="checkbox"/> d. The prospective permittee contacted local authorities (e.g. harbormaster, select board, shellfish constable) for authorization of their facility prior to commencing work.</p>  |  |
| <p>21. ADDITIONAL INFORMATION/ATTACHMENTS (<i>see instructions</i>)</p> <p><input checked="" type="checkbox"/> a. The project plans are enclosed in this SVN submittal (see block 17).</p> <p><input type="checkbox"/> b. The activity <b>IS NOT</b> funded through the Bipartisan Infrastructure Bill (also known as the Infrastructure Investment and Jobs Act).</p> <p><input checked="" type="checkbox"/> c. All required state, local and federal approvals were acquired prior to starting construction in USACE jurisdiction.</p> <p><input checked="" type="checkbox"/> d. After construction of the activity is completed, a complete Certificate of Compliance will be submitted to USACE.</p>   |  |
| <p>22. IS THERE ANOTHER LEAD FEDERAL AGENCY:</p> <p><input type="checkbox"/> YES <input checked="" type="checkbox"/> NO</p>  |  |

23. STATEMENT OF AUTHORIZATION *(see instructions)*

I certify that I possess the authority to undertake the work described herein or am acting as the duly authorized agent of the applicant.

|  |               |  |               |
|--|---------------|--|---------------|
| <b>Courtney Walker</b><br><small>Digitally signed by Courtney Walker<br/>Date: 2023.08.01 13:24:02 -04'00'</small> | <b>8/1/23</b> | <b>Gregory A Russo</b><br><small>Digitally signed by Gregory A Russo<br/>Date: 2023.08.04 13:48:31 -04'00'</small> | <b>8/4/23</b> |
| SIGNATURE OF APPLICANT   | DATE          | SIGNATURE OF AGENT   | DATE          |

24. SIGNATURES *(see instructions)*

I hereby certify that the information in this Self-Verification Notification is complete and accurate. As the applicant or their duly authorized agent, I certify the activity was completed in accordance with the terms and conditions of the GP. This includes all applicable terms, general conditions, and activity-specific GP criteria. I agree to allow the duly authorized representatives of the Corps of Engineers Regulatory Program and other regulatory or advisory agencies to enter upon the premises of the project site at reasonable times to evaluate inspect and photograph site conditions. This consent to enter the property is superior to, takes precedence over, and waives any communication to the contrary. For example, if the property is posted as "no trespassing" this consent specifically supersedes and waives that prohibition and grants permission to enter the property despite such posting.

|  |               |  |               |
|--|---------------|--|---------------|
| <b>Courtney Walker</b><br><small>Digitally signed by Courtney Walker<br/>Date: 2023.08.01 13:24:24 -04'00'</small> | <b>8/1/23</b> | <b>Gregory A Russo</b><br><small>Digitally signed by Gregory A Russo<br/>Date: 2023.08.04 13:49:01 -04'00'</small> | <b>8/4/23</b> |
| SIGNATURE OF APPLICANT   | DATE          | SIGNATURE OF AGENT   | DATE          |

18 U.S.C. Section 1001 provides that: Whoever, in any manner within the jurisdiction of any department or agency of the United States knowingly and willfully falsifies, conceals, or covers up any trick, scheme, or disguises a material fact or makes any false, fictitious or fraudulent statements or representations or makes or uses any false writing or document knowing same to contain any false, fictitious or fraudulent statements or entry, shall be fined not more than \$10,000 or imprisoned not more than five years or both.

**Instructions for Preparing a  
Department of the Army  
General Permit (GP) Self-Verification**

**Blocks 1 through 3.** To be completed by the Corps of Engineers.

**Block 4. Applicant' Name.** Enter the name and the e-mail address of the responsible party or parties. If the responsible party is an agency, company, corporation, or other organization, indicate the name of the organization and responsible officer and title. If more than one party is associated with the self-verification, please attach a sheet of paper with the necessary information marked Block 4.

**Block 5. Address of Applicant.** Please provide the full address of the party or parties responsible for the self-verification. If more space is needed, attach an extra sheet of paper marked Block 5.

**Block 6. Applicant Telephone Number(s).** Please provide the telephone number where you can usually be reached during normal business hours.

**Blocks 7 through 9.** To be completed, if you choose to have an agent.

**Block 7. Authorized Agent's Name and Title.** Indicate name of individual or agency, designated by you, to represent you in this process. An agent can be an attorney, builder, contractor, engineer, consultant, or any other person or organization. Note: An agent is not required.

**Blocks 8 and 9. Agent's Address and Telephone Number.** Please provide the complete mailing address of the agent, along with the telephone number where they can be reached during normal business hours.

**Block 10. Proposed General Permit Activity Name or Title.** Please provide a name identifying the proposed GP activity, e.g., Windward Marina, Rolling Hills Subdivision, or Smith Commercial Center.

**Block 11. File Number(s) of Previous USACE Actions on the Site** Please provide any known USACE file number. If the activity does not have a known USACE file number, you may state N/A.

**Block 12. Name of Waterbody.** Please provide the name (if it has a name) of any stream, lake, marsh, or other waterway to be directly impacted by the GP activity. If it is a minor (no name) stream, identify the waterbody the minor stream enters.

**Block 13. Proposed Activity Coordinates.** Please enter the latitude and longitude of where the proposed GP activity is located. Indicate whether the project location provided is the center of the project or whether the project location is provided as the latitude and longitude for each of the "corners" of the project area. If there are multiple sites, please list the latitude and longitude of each site (center or corners) on a separate sheet of paper and mark as Block 13.

**Block 14. Proposed Activity Street Address.** If the proposed activity is located at a site having a street address (not a box number), enter it in Block 14.

**Block 15. General Permit Activity Type.** Please select all GP activity types that apply to the proposed activity. A list of GP activity types can be found in Section III of the GP.

**Block 16. Summary of Project Impacts.** Please provide ALL proposed impacts, both temporary and permanent in duration, that are located in Waters of the United States. The area of impact shall be provided in square feet (SF). When applicable, impacts that result in conversion of stream bank or shoreline must also be identified in linear feet (LF). Dredging or the discharge of dredged or fill material shall also include the volume, cubic yards (CY), of material removed from or placed into Waters of the U.S. If more entries are required, please attach a table matching the desired format in Block 16.

**Block 17. Project Plans.** Please verify that items a-g are included in the project plans. Three types of illustrations are necessary to properly depict the proposed work. These illustrations or drawings are identified as a Vicinity Map, a Plan View (Aerial view) and a Cross Section Map. For linear projects (e.g. roads, subsurface utility lines, etc.) gradient drawings (longitudinal profile) should also be included. Plans must accurately depict the existing conditions and all aspects of the proposed activity located in waters of the U.S. Please submit one copy of all drawings formatted to print on 8½ x 11 inch or 11 x 17 inch plain white paper. Use the fewest number of sheets necessary for your drawings or illustrations. Each illustration should identify the project, the applicant, and the type of illustration (vicinity map, plan view, or cross section). While illustrations need not be certified engineering sheets; they should be clear, accurate, contain all necessary information, and depict all proposed work. Each submission must also include a delineation of wetlands, other special aquatic sites, and other waters, such as lakes and ponds, and perennial, intermittent, and ephemeral streams, on the project site. Wetland delineations must be prepared in accordance with the current wetland delineation manual and regional supplement published by USACE.

**Block 18. Avoidance & Minimization.** Please verify that items a-d have been implemented for the proposed activity.

**Block 19. Due Diligence.** Please complete all the fields and submit documentation to USACE to demonstrate compliance with the above requirements. This Documentation may include emails, letters, meeting notes, phone call log, project narrative, project plans, a species list from the NOAA Section 7 Mapper, a completed copy of the IPAC determination keys, etc. Documentation should be limited to what is necessary to demonstrate how the proposed activity meets each requirement. Refer to the MA GP, Appendix A, for specific guidance on the identification of previously identified historic properties and previously unidentified historic properties. Endangered Species: \*The applicant must be designated as the non-federal representative for the purposes of Section 7 consultation to select the Rangewide D-Key options. Otherwise, the applicant shall select the following option when IPAC indicates the NLEB is present: "The activity IS located within the NLEB Species Range (PCN Required)."

**Block 20. Aquaculture Activities.** Please verify that items a-d have been obtained or completed prior to commencing work in waters of the U.S.

**Block 21. Additional Information/Attachments.** Please verify that items a-d have been completed prior to commencing work in waters of the U.S.

**Block 22. Lead Federal Agency.** Please identify if there is another lead federal agency involved with the proposed activity. Enter the lead federal agency name (e.g., the Federal Emergency Management Agency, FEMA) and the agency's designated person of contact for the activity.

**Block 23. Statement of Authorization.** The applicant shall sign this section for all activities. If an agent is to be employed, the agent shall sign this section.

**Block 24. Signatures.** The SVN must be signed by the person proposing to undertake the GP activity, and if applicable, the authorized party (agent) that prepared the SVN. The signature of the person proposing to undertake the GP activity shall be an affirmation that the party submitting the SVN possesses the requisite property rights to undertake the GP activity.



# **Attachment A**

## **Plans and Figures**

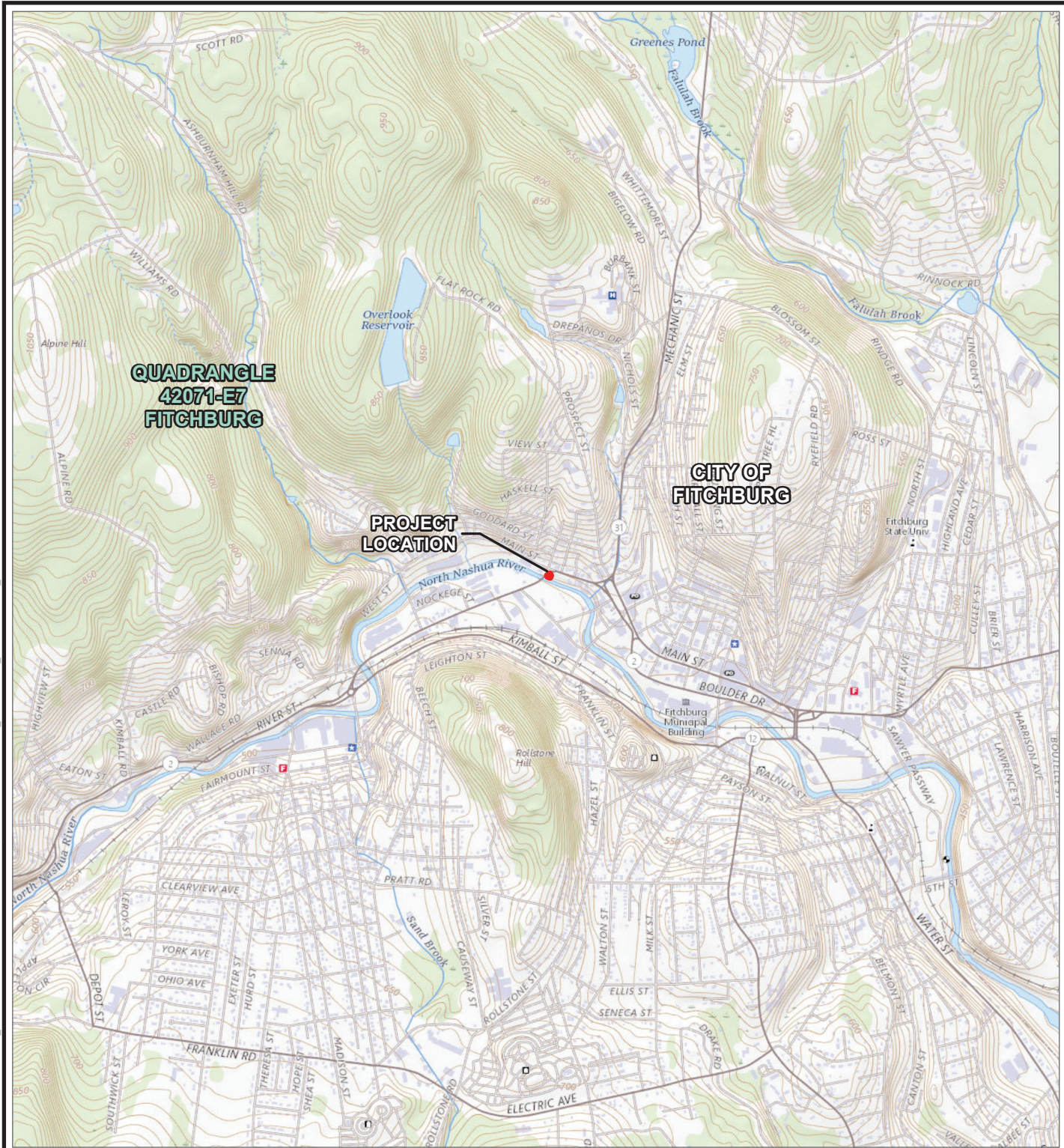





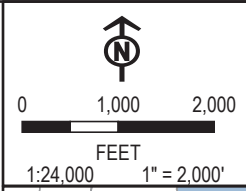





COORDINATE SYSTEM: NAD 1983 STATEPLANE MASSACHUSETTS MAINLAND FIPS 2001; MAP ROTATION: 0  
 - SAVED BY: SMOTURI ON 6/28/2023, 12:06:44 PM. FILE PATH: T:\1-PROJECTS\STV\502516\_FITCHBURG\2-APPX\FITCHBURG.APRX; LAYOUT NAME: FIG1\_FITCHBURG\_SITELLOCATION\_8.6X11P

LIMIT OF WORK



|              |             |  |        |
|--------------|-------------|--|--------|
| PROJECT:     |             | <b>STV INC</b>   |        |
|              |             | <b>RIVER STREET (BRIDGE NO. F-04-010)</b>                                  |        |
|              |             | <b>FITCHBURG, MA</b>   |        |
| TITLE:       |             | <b>USGS LOCUS</b>  |        |
| DRAWN BY:    | S. MOTURI   | PROJ. NO.:   | 502516 |
| CHECKED BY:  | M. BILLINGS | <b>FIGURE 1</b>  |        |
| APPROVED BY: | G. RUSSO    |  |        |
| DATE:        | JUNE 2023   | 650 SUFFOLK STREET<br>SUITE 200<br>LOWELL, MA 01854<br>PHONE: 978.970.5600 |        |
| FILE:        |             | FITCHBURG  |        |

BASE MAP: ESRI "USGS TOPO" SERVICE  
 DATA SOURCES: TRC

-  LIMIT OF WORK
-  CULVERT REPLACEMENT AREA
-  CULVERT
-  STREAM PLOT
-  STREAM FLAG
-  DELINEATED PERENNIAL STREAM BANK
-  100-FT BUFFER ZONE
-  200-FT RIVERFRONT AREA
-  SPECIAL FLOOD HAZARD AREA (1-PERCENT ANNUAL CHANCE FLOOD OR 100-YEAR FLOOD - FEMA)
-  BASE MAP: MASSGIS 2021 ORTHO PHOTOS.
-  DATA SOURCES: TRC



|              |             |  |         |
|--------------|-------------|--|---------|
| PROJECT:     |             | STV INC<br>RIVER STREET (BRIDGE NO. F-04-010)<br>FITCHBURG, MA |         |
| TITLE:       |             | DELINEATION MAP  |         |
| DRAWN BY:    | S. MOTURI   | PROJ. NO.:   | 5102516 |
| CHECKED BY:  | M. BILLINGS |  |         |
| APPROVED BY: | G. RIGGIO   |  |         |
| DATE:        | JUNE 2023   |  |         |

**FIGURE 2**

650 SUFFOLK STREET  
LOWELL, MA 01854  
PHONE: 978.970.5800



F. FILE: Fitchburg.aprx



Coordinate System: NAD 1983 StatePlane Massachusetts Mainland FIPS 2001 Feet, Map Rotation: 0  
 Scale: 1"=60' (1:720) on 6/28/2023 12:06:44 PM. File Path: T:\PROJECTS\7171\022516\_Fitchburg\_Delineation.aprx  
 Layer Name: Rfgs\_Fitchburg\_Delineation.aprx

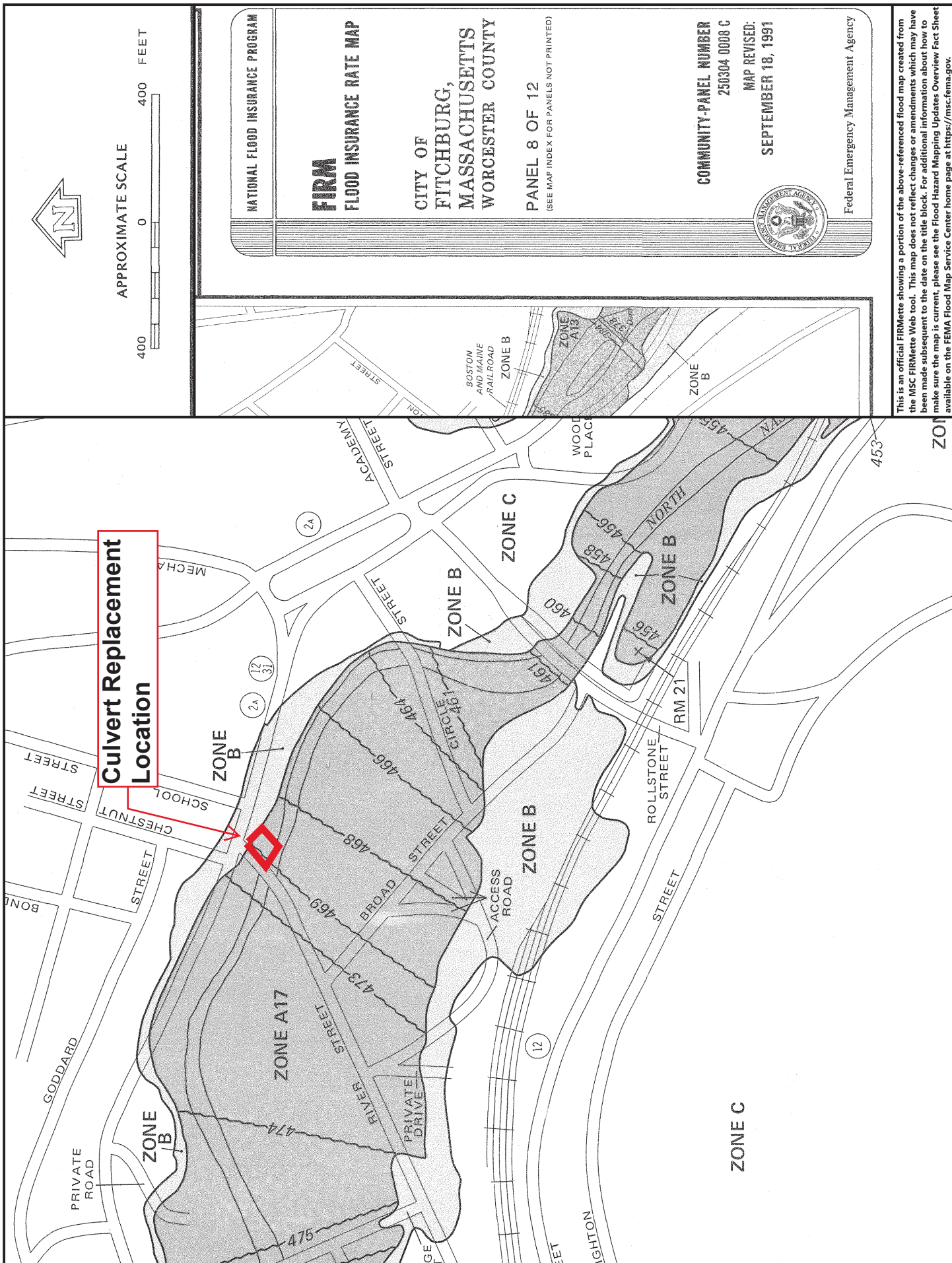

**Culvert Replacement Location**

NATIONAL FLOOD INSURANCE PROGRAM

**FIRM**  
FLOOD INSURANCE RATE MAP

CITY OF  
FITCHBURG,  
MASSACHUSETTS  
WORCESTER COUNTY

PANEL 8 OF 12  
(SEE MAP INDEX FOR PANELS NOT PRINTED)

COMMUNITY-PANEL NUMBER  
250304 0008 C

MAP REVISED:  
SEPTEMBER 18, 1991

Federal Emergency Management Agency

This is an official FIRMette showing a portion of the above-referenced flood map created from the MSC FIRMette Web tool. This map does not reflect changes or amendments which may have been made subsequent to the date on the title block. For additional information about how to make sure the map is current, please see the Flood Hazard Mapping Updates Overview Fact Sheet available on the FEMA Flood Map Service Center home page at <https://msc.fema.gov>.

# MASSACHUSETTS DEPARTMENT OF TRANSPORTATION HIGHWAY DIVISION

PLAN AND PROFILE OF  
RIVER STREET  
(BRIDGE NO. F-04-010)  
IN THE CITY OF  
FITCHBURG  
WORCESTER COUNTY

|                                    |        |
|------------------------------------|--------|
| FITCHBURG<br>RIVER STREET/ROUTE 31 |        |
| STATE                              | MA     |
| REG. APPROV. NO.                   | 1      |
| PROJECT FILE NO.                   | 607680 |
| NO.                                | 1      |
| SHEET                              | 08     |

TITLE SHEET & INDEX

THESE PLANS ARE SUPERSEDED BY THE 2005 STANDARD SPECIFICATIONS, THE LATEST SUPPLEMENTAL SPECIFICATIONS, THE OCTOBER 2017 CONSTRUCTION STANDARD DETAILS, THE 2015 OVERHEAD SIGNAL STRUCTURE AND FOUNDATION STANDARD DRAWINGS, MASSDOT TRAFFIC MANAGEMENT PLANS AND DETAIL DRAWINGS, THE 1900 STANDARD DRAWINGS FOR SIGNS AND SUPPORTS, THE 1908 STANDARD DRAWINGS FOR TRAFFIC SIGNALS AND HIGHWAY LIGHTING, AND THE LATEST EDITION OF THE AMERICAN STANDARD FOR NURSERY STOCK.

**DESIGN DESIGNATION (RIVER STREET/RT 31)**

|                           |                          |
|---------------------------|--------------------------|
| DESIGN SPEED              | 25 MPH                   |
| ADT (2025)                | 12,302                   |
| ADT (2045)                | 15,010                   |
| K                         | 8.7%                     |
| D                         | 58%                      |
| T (PEAK HOUR)             | 6.97%                    |
| T (AVERAGE DAY)           | 5.15%                    |
| DDV                       | 1343                     |
| DDV                       | 721                      |
| FUNCTIONAL CLASSIFICATION | Urban Principal Arterial |

WITH CONSULTANT:  
**C&C**  
CONSULTING ENGINEERS, LLC  
214 Lincoln St  
Boston, MA 02114  
T: 617.254.6930  
F: 617.254.7631

Designed By  
**STV** Incorporated  
One Financial Center  
Boston, MA 02111  
T: 617.482.7289  
F: 617.482.1837

## PS&E SUBMITTAL

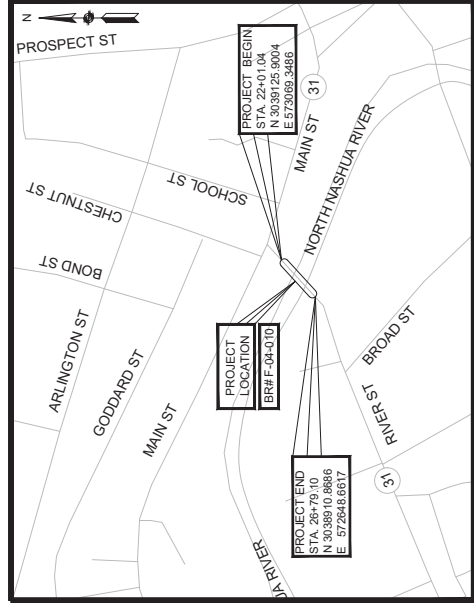

LENGTH OF PROJECT = 480 FEET = 0.09 MILES

**INDEX**

| SHEET NO. | DESCRIPTION  |
|-----------|--|
| 1         | TITLE SHEET & INDEX                                  |
| 2         | LEGEND & ABBREVIATIONS                               |
| 3         | GENERAL NOTES  |
| 4         | KEY PLAN & BORING PLAN                               |
| 5         | TYPICAL SECTIONS & PAVEMENT NOTES                    |
| 6         | SURVEY CONTROL & CONSTRUCTION BASELINE TIES          |
| 7         | CONSTRUCTION PLANS                                   |
| 8         | PROFILE  |
| 9         | CURB TIE PLANS                                       |
| 10        | GRADING PLANS  |
| 11        | DRAINAGE & UTILITY PLANS                             |
| 12        | DRAINAGE & UTILITY DETAILS 1 OF 2                    |
| 13        | DRAINAGE & UTILITY DETAILS 2 OF 2                    |
| 14        | TRAFFIC SIGNS & PAVEMENT MARKINGS                    |
| 15        | TRAFFIC SIGN SUMMARY SHEET                           |
| 16        | TEMPORARY TRAFFIC CONTROL PLAN GENERAL NOTES         |
| 17        | TEMPORARY TRAFFIC CONTROL PLANS - PHASE 1A & 1B      |
| 18        | TEMPORARY TRAFFIC CONTROL PLANS - PHASE 2A & 2B      |
| 19        | TEMPORARY TRAFFIC CONTROL PLANS - TYPICAL DETAILS    |
| 20        | TEMPORARY TRAFFIC CONTROL PLANS - TRAFFIC DETOUR     |
| 21        | TEMPORARY TRAFFIC CONTROL PLANS - SIGN SUMMARY TABLE |
| 22        | CONSTRUCTION DETAILS                                 |
| 23        | PEDESTRIAN CURB RAMP & DRIVEWAY DETAILS 1 OF 2       |
| 24        | PEDESTRIAN CURB RAMP & DRIVEWAY DETAILS 2 OF 2       |
| 25-62     | CROSS SECTIONS                                       |
| 63-68     |  |

|            |                |       |
|------------|----------------|-------|
| 07/20/2023 | PS&E SUBMITTAL | 1     |
| 08/09/2023 | PS&E SUBMITTAL |       |
| 08/10/2023 | 100% SUBMITTAL |       |
| 08/02/2022 | 75% SUBMITTAL  |       |
| 08/18/2020 | 25% SUBMITTAL  |       |
| DATE       | DESCRIPTION    | REV # |



APPROVED  
\_\_\_\_\_  
CHIEF ENGINEER  
DATE

| GENERAL SYMBOLS |   | TRAFFIC SYMBOLS |          | ABBREVIATIONS                                  |  | ABBREVIATIONS (cont.)                          |  |
|-----------------|---|-----------------|----------|--|--|--|--|
| EXISTING        | PROPOSED  | EXISTING        | PROPOSED | GENERAL  | TRAFFIC SIGNAL                                 | GENERAL  | TRAFFIC SIGNAL                                 |
|                 | JERSEY BARRIER  |                 | CAB      | ADOT   | ANNUAL AVERAGE DAILY TRAFFIC                   | ADOT   | ANNUAL AVERAGE DAILY TRAFFIC                   |
|                 | CATCH BASIN   |                 | GSR      | ADULT  | ADULT  | ADULT  | ADULT  |
|                 | CATCH BASIN WITH CURBSIDE INLET                           |                 | GV       | ADJUST   | ADJUST   | ADJUST   | ADJUST   |
|                 | GAS RAMP  |                 | OL       | ADDITIONAL                                     | ADDITIONAL                                     | ADDITIONAL                                     | ADDITIONAL                                     |
|                 | MAIL BOX  |                 | PED      | APPROACH                                       | APPROACH                                       | APPROACH                                       | APPROACH                                       |
|                 | POST SQUARE   |                 | PTZ      | APPROXIMATE                                    | APPROXIMATE                                    | APPROXIMATE                                    | APPROXIMATE                                    |
|                 | WELL  |                 | RL       | ASPHALT CONCRETE                               | ASPHALT CONCRETE                               | ASPHALT CONCRETE                               | ASPHALT CONCRETE                               |
|                 | ELECTRIC HANDHOLE   |                 | RR       | ASPHALT FIBER REINFORCED CORRUGATED METAL PIPE | ASPHALT FIBER REINFORCED CORRUGATED METAL PIPE | ASPHALT FIBER REINFORCED CORRUGATED METAL PIPE | ASPHALT FIBER REINFORCED CORRUGATED METAL PIPE |
|                 | GAS GATE POST   |                 | YL       | AT&T PIPE                                      | AT&T PIPE                                      | AT&T PIPE                                      | AT&T PIPE                                      |
|                 | GAS GATE  |                 | YR       | BITUMINOUS                                     | BITUMINOUS                                     | BITUMINOUS                                     | BITUMINOUS                                     |
|                 | BORING HOLE   |                 | FLYL     | BOUND  | BOUND  | BOUND  | BOUND  |
|                 | MONITORING WELL   |                 | FLYR     | BOUNDARY                                       | BOUNDARY                                       | BOUNDARY                                       | BOUNDARY                                       |
|                 | TEST PIT  |                 | GL       | BOUNDING                                       | BOUNDING                                       | BOUNDING                                       | BOUNDING                                       |
|                 | HYDRANT   |                 | GR       | BRIDGE   | BRIDGE   | BRIDGE   | BRIDGE   |
|                 | LIGHT POLE  |                 | YLR      | BRIDGE   | BRIDGE   | BRIDGE   | BRIDGE   |
|                 | COUNTY BOUND  |                 | YL       | BRIDGE   | BRIDGE   | BRIDGE   | BRIDGE   |
|                 | CABLE MANHOLE   |                 | CAB      | BRIDGE   | BRIDGE   | BRIDGE   | BRIDGE   |
|                 | DRAINAGE MANHOLE  |                 | GSR      | BRIDGE   | BRIDGE   | BRIDGE   | BRIDGE   |
|                 | ELECTRIC MANHOLE  |                 | OL       | BRIDGE   | BRIDGE   | BRIDGE   | BRIDGE   |
|                 | MISC MANHOLE  |                 | FL       | BRIDGE   | BRIDGE   | BRIDGE   | BRIDGE   |
|                 | SEWER MANHOLE   |                 | FR       | BRIDGE   | BRIDGE   | BRIDGE   | BRIDGE   |
|                 | TELEPHONE MANHOLE   |                 | RL       | BRIDGE   | BRIDGE   | BRIDGE   | BRIDGE   |
|                 | MASSACHUSETTS HIGHWAY BOUND                               |                 | RR       | BRIDGE   | BRIDGE   | BRIDGE   | BRIDGE   |
|                 | STONE BOUND   |                 | FY       | BRIDGE   | BRIDGE   | BRIDGE   | BRIDGE   |
|                 | TOWN OR CITY BOUND  |                 | FLYL     | BRIDGE   | BRIDGE   | BRIDGE   | BRIDGE   |
|                 | TRAVERSE OR TRIANGULATION STATION                         |                 | FLYR     | BRIDGE   | BRIDGE   | BRIDGE   | BRIDGE   |
|                 | TROLLEY POLE OR GUY POLE                                  |                 | SG       | BRIDGE   | BRIDGE   | BRIDGE   | BRIDGE   |
|                 | TRANSMISSION POLE   |                 | SY       | BRIDGE   | BRIDGE   | BRIDGE   | BRIDGE   |
|                 | UTILITY POLE WITH DOUBLE LIGHT                            |                 | YL       | BRIDGE   | BRIDGE   | BRIDGE   | BRIDGE   |
|                 | UTILITY POLE W/1 LIGHT                                    |                 | YR       | BRIDGE   | BRIDGE   | BRIDGE   | BRIDGE   |
|                 | UTILITY POLE  |                 | GL       | BRIDGE   | BRIDGE   | BRIDGE   | BRIDGE   |
|                 | BUSH  |                 | GR       | BRIDGE   | BRIDGE   | BRIDGE   | BRIDGE   |
|                 | TREE  |                 | YLR      | BRIDGE   | BRIDGE   | BRIDGE   | BRIDGE   |
|                 | SWAMP   |                 | YL       | BRIDGE   | BRIDGE   | BRIDGE   | BRIDGE   |
|                 | MARSH   |                 | CAB      | BRIDGE   | BRIDGE   | BRIDGE   | BRIDGE   |
|                 | PARKING METER   |                 | GSR      | BRIDGE   | BRIDGE   | BRIDGE   | BRIDGE   |
|                 | OVERHEAD CABLE/WIRE                                       |                 | OL       | BRIDGE   | BRIDGE   | BRIDGE   | BRIDGE   |
|                 | CURBING   |                 | FL       | BRIDGE   | BRIDGE   | BRIDGE   | BRIDGE   |
|                 | CONTOURS (PHOTOGRAMMETRIC DATA)                           |                 | FR       | BRIDGE   | BRIDGE   | BRIDGE   | BRIDGE   |
|                 | UNDERGROUND DRAIN PIPE (DOUBLE LINE 24 INCH AND OVER)     |                 | RL       | BRIDGE   | BRIDGE   | BRIDGE   | BRIDGE   |
|                 | UNDERGROUND GAS MAIN (DOUBLE LINE 24 INCH AND OVER)       |                 | RR       | BRIDGE   | BRIDGE   | BRIDGE   | BRIDGE   |
|                 | UNDERGROUND SEWER MAIN (DOUBLE LINE 24 INCH AND OVER)     |                 | FY       | BRIDGE   | BRIDGE   | BRIDGE   | BRIDGE   |
|                 | UNDERGROUND TELEPHONE DUCT (DOUBLE LINE 24 INCH AND OVER) |                 | FLYL     | BRIDGE   | BRIDGE   | BRIDGE   | BRIDGE   |
|                 | UNDERGROUND WATER MAIN (DOUBLE LINE 24 INCH AND OVER)     |                 | FLYR     | BRIDGE   | BRIDGE   | BRIDGE   | BRIDGE   |
|                 | BALANCED STONE WALL                                       |                 | SG       | BRIDGE   | BRIDGE   | BRIDGE   | BRIDGE   |
|                 | GUARD RAIL - STEEL POSTS                                  |                 | SY       | BRIDGE   | BRIDGE   | BRIDGE   | BRIDGE   |
|                 | GUARD RAIL - DOUBLE FACE - WOOD POSTS                     |                 | YL       | BRIDGE   | BRIDGE   | BRIDGE   | BRIDGE   |
|                 | CHAIN LINK OR METAL FENCE                                 |                 | YR       | BRIDGE   | BRIDGE   | BRIDGE   | BRIDGE   |
|                 | WOOD FENCE  |                 | GL       | BRIDGE   | BRIDGE   | BRIDGE   | BRIDGE   |
|                 | WOOD POSTS  |                 | GR       | BRIDGE   | BRIDGE   | BRIDGE   | BRIDGE   |
|                 | COMPOSITE FILTER TUBES                                    |                 | YLR      | BRIDGE   | BRIDGE   | BRIDGE   | BRIDGE   |
|                 | SAWCUT LINE   |                 | YL       | BRIDGE   | BRIDGE   | BRIDGE   | BRIDGE   |
|                 | EDGE OF PAVEMENT OR COLD PLANE AND OVERLAY                |                 | CAB      | BRIDGE   | BRIDGE   | BRIDGE   | BRIDGE   |
|                 | BANK OF RIVER OR STREAM                                   |                 | GSR      | BRIDGE   | BRIDGE   | BRIDGE   | BRIDGE   |
|                 | BORDER OF WETLAND   |                 | OL       | BRIDGE   | BRIDGE   | BRIDGE   | BRIDGE   |
|                 | 100 FT WETLAND BUFFER                                     |                 | FL       | BRIDGE   | BRIDGE   | BRIDGE   | BRIDGE   |
|                 | 200 FT WETLAND BUFFER                                     |                 | FR       | BRIDGE   | BRIDGE   | BRIDGE   | BRIDGE   |
|                 | STATE HIGHWAY LAYOUT                                      |                 | RL       | BRIDGE   | BRIDGE   | BRIDGE   | BRIDGE   |
|                 | TOWN OR CITY LAYOUT                                       |                 | RR       | BRIDGE   | BRIDGE   | BRIDGE   | BRIDGE   |
|                 | TOWN OR CITY BOUNDARY LINE                                |                 | FY       | BRIDGE   | BRIDGE   | BRIDGE   | BRIDGE   |
|                 | PROPERTY LINE OR APPROXIMATE PROPERTY LINE                |                 | FLYL     | BRIDGE   | BRIDGE   | BRIDGE   | BRIDGE   |
|                 | EASEMENT  |                 | FLYR     | BRIDGE   | BRIDGE   | BRIDGE   | BRIDGE   |
|                 | ELECTRIC  |                 | SG       | BRIDGE   | BRIDGE   | BRIDGE   | BRIDGE   |
|                 | GAS-OIL/STEAM   |                 | SY       | BRIDGE   | BRIDGE   | BRIDGE   | BRIDGE   |
|                 | COMMUNICATION/CTV   |                 | YL       | BRIDGE   | BRIDGE   | BRIDGE   | BRIDGE   |
|                 | POTABLE WATER   |                 | YR       | BRIDGE   | BRIDGE   | BRIDGE   | BRIDGE   |
|                 | SEWER   |                 | GL       | BRIDGE   | BRIDGE   | BRIDGE   | BRIDGE   |
|                 | DRAINAGE  |                 | GR       | BRIDGE   | BRIDGE   | BRIDGE   | BRIDGE   |
|                 | TRADITIONAL GRAYSCALE                                     |                 | YLR      | BRIDGE   | BRIDGE   | BRIDGE   | BRIDGE   |
|                 | DRAINAGE  |                 | YL       | BRIDGE   | BRIDGE   | BRIDGE   | BRIDGE   |



607680\_01\_07 (CONSTRUCTION PLANS) DWG  
 2023-11-21 11:21 AM

|  |                |                  |      |
|--|----------------|------------------|------|
| FITCHBURG<br>RIVER STREET/ROUTE 31<br>CONSTRUCTION PLANS |                |                  |      |
| STATE  | FED. PROJ. NO. | PROJECT FILE NO. | DATE |
| MA   | -              | 607680           | 08   |
|  |                |                  | 7    |

200' RIVERFRONT AREA

200' RIVERFRONT AREA

200' RIVERFRONT AREA

200' RIVERFRONT AREA

200' RIVERFRONT AREA

200' RIVERFRONT AREA

200' RIVERFRONT AREA

200' RIVERFRONT AREA

200' RIVERFRONT AREA

200' RIVERFRONT AREA

200' RIVERFRONT AREA

200' RIVERFRONT AREA

200' RIVERFRONT AREA

200' RIVERFRONT AREA

200' RIVERFRONT AREA

200' RIVERFRONT AREA

200' RIVERFRONT AREA

200' RIVERFRONT AREA

200' RIVERFRONT AREA

200' RIVERFRONT AREA

200' RIVERFRONT AREA

200' RIVERFRONT AREA

200' RIVERFRONT AREA

200' RIVERFRONT AREA

200' RIVERFRONT AREA

200' RIVERFRONT AREA

200' RIVERFRONT AREA

200' RIVERFRONT AREA

200' RIVERFRONT AREA

200' RIVERFRONT AREA

200' RIVERFRONT AREA

200' RIVERFRONT AREA

200' RIVERFRONT AREA

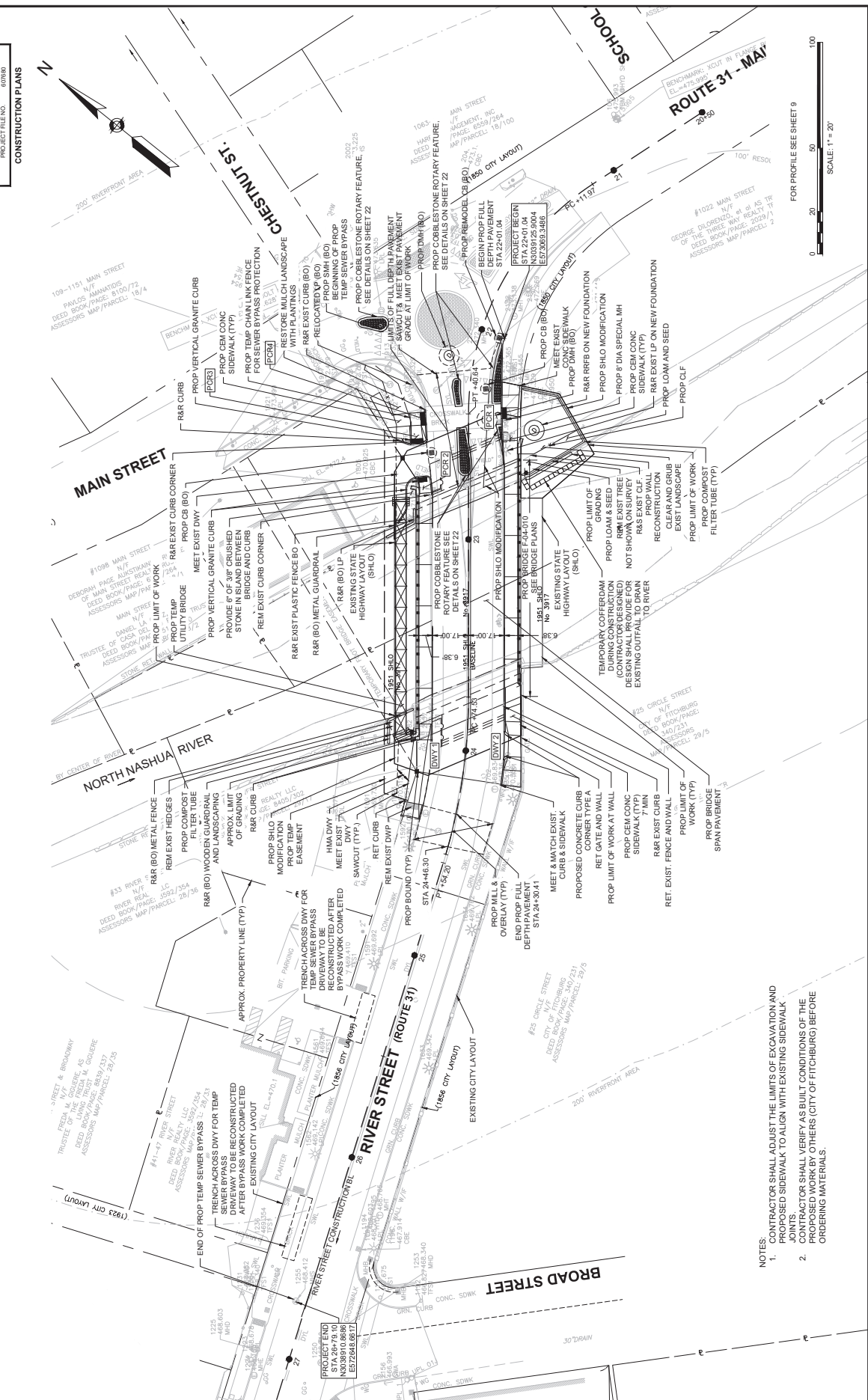

DRAINAGE DETAILS  
SEE SHEET 12-13

DRAINAGE & UTILITY PLANS  
SEE SHEET 11

TRAFFIC SIGNAL CONDUIT  
NONE

HIGHWAY GUARD DETAILS  
NONE

- NOTES:
- CONTRACTOR SHALL ADJUST THE LIMITS OF EXCAVATION AND PROPOSED SIDEWALK TO ALIGN WITH EXISTING SIDEWALK JOINTS.
  - CONTRACTOR SHALL VERIFY AS BUILT CONDITIONS OF THE PROPOSED WORK BY OTHERS (CITY OF FITCHBURG) BEFORE ORDERING MATERIALS.

FOR PROFILE SEE SHEET 9  
SCALE: 1" = 20'



607680\_HJ\_10 (GRADING PLANS).DWG PLOTTED ON 20-JUL-2023 11:25 AM

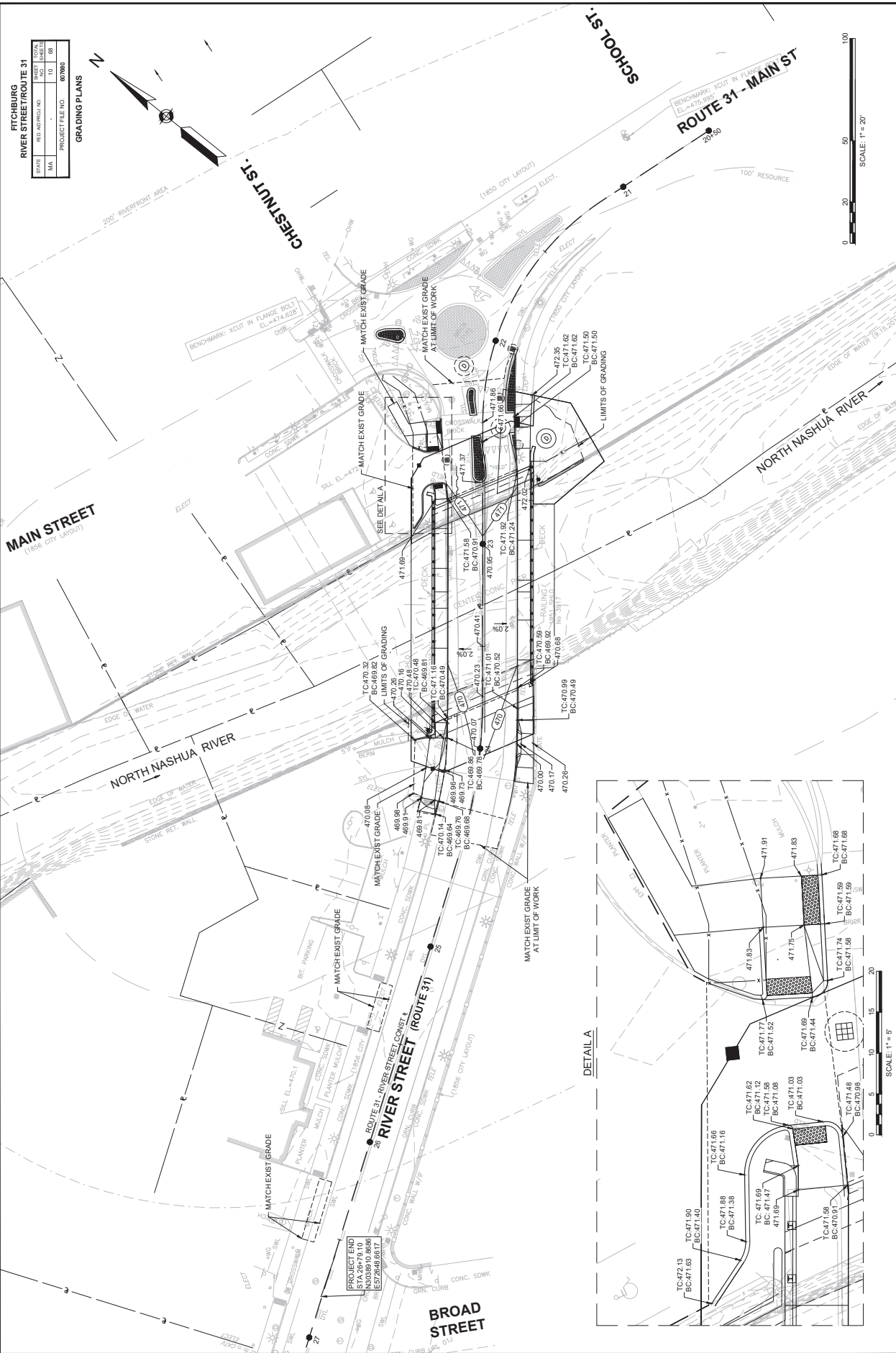

**PROJECT INFORMATION**

|                   |        |
|-------------------|--------|
| STATE             | MA     |
| PROJECT FILE NO.  | 607680 |
| DATE              | 10/08  |
| REV. APPROVAL NO. | 10     |
| REV. SHEET NO.    | 08     |

**GRADING PLANS**

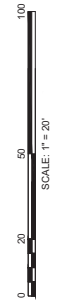

|  |                |        |           |
|--|----------------|--------|-----------|
| FITCHBURG<br>RIVER STREET (ROUTE 31)<br>DRAINAGE & UTILITY PLANS |                |        |           |
| STATE  | FED. PROJ. NO. | NO.    | SHEET NO. |
| MA   | -              | 11     | 08        |
| PROJECT FILE NO.   |                | 607680 |           |

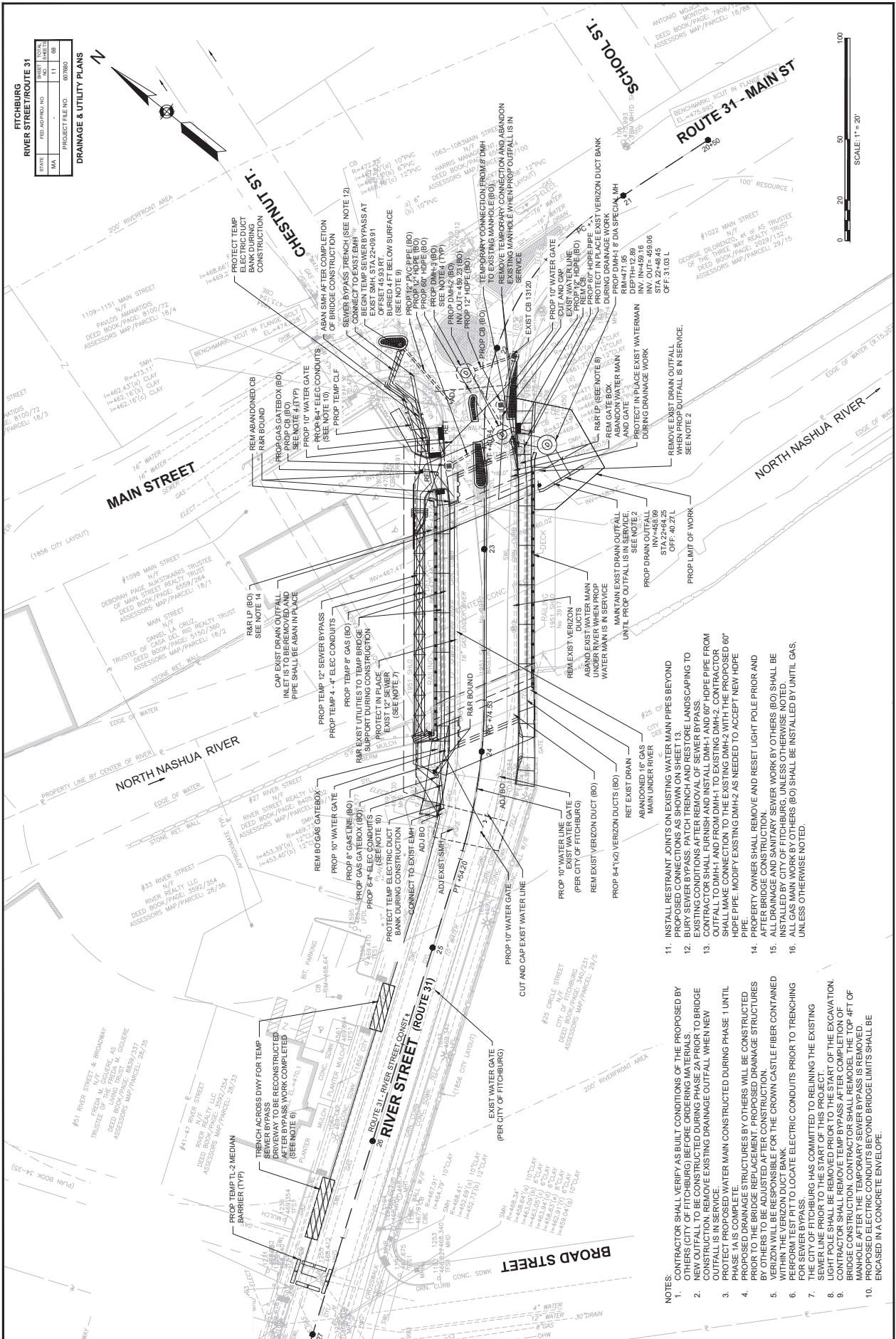

- NOTES:**
- CONTRACTOR SHALL VERIFY AS BUILT CONDITIONS OF THE PROPOSED BY PHASE 1A AND PHASE 1B BEFORE CONSTRUCTION OF PHASE 2A.
  - NEW OUTFALL TO BE CONSTRUCTED DURING PHASE 2A PRIOR TO BRIDGE CONSTRUCTION. REMOVE EXISTING DRAINAGE OUTFALL WHEN NEW OUTFALL IS IN SERVICE.
  - PROTECT PROPOSED WATER MAIN CONSTRUCTED DURING PHASE 1 UNTIL PHASE 1A IS COMPLETE. STRUCTURES BY OTHERS WILL BE CONSTRUCTED PRIOR TO THE BRIDGE REPLACEMENT. PROPOSED DRAINAGE STRUCTURES BY OTHERS TO BE ADJUSTED AFTER CONSTRUCTION.
  - VERIZON WILL BE RESPONSIBLE FOR THE CROWN CASTLE FIBER CONTAINED WITHIN THE VERIZON DUCT BANK.
  - PERFORM TEST PIT TO LOCATE ELECTRIC CONDUITS PRIOR TO TRENCHING.
  - THE CITY OF FITCHBURG HAS COMMITTED TO REINJURING THE EXISTING SEWER LINE PRIOR TO THE START OF THIS PROJECT.
  - LIGHT POLE SHALL BE REMOVED PRIOR TO THE START OF THE EXCAVATION. CONTRACTOR SHALL REMOVE TEMP BYPASS AFTER COMPLETION OF BRIDGE CONSTRUCTION. CONTRACTOR SHALL REMODEL THE TOP 4 FT OF EXISTING CONCRETE CURB AND GUTTER. ALL UTILITIES SHALL BE PROPOSED ELECTRIC CONDUITS SECTION AND BRIDGE LIMITS SHALL BE ENCASED IN A CONCRETE ENVELOPE.
  - CONTRACTOR SHALL VERIFY AS SHOWN ON SHEET 10. LANDSCAPING TO EXISTING CONDITIONS AFTER REMOVAL OF SEWER BYPASS.
  - CONTRACTOR SHALL FURNISH AND INSTALL DMH-1 AND 80" HDPE PIPE FROM OUTFALL TO DMH-1 AND FROM DMH-1 TO EXISTING DMH-2. CONTRACTOR SHALL MAKE CONNECTION TO THE EXISTING DMH-2 WITH THE PROPOSED 80" HDPE PIPE. MODIFY EXISTING DMH-2 AS NEEDED TO ACCEPT NEW HDPE PIPE.
  - PROPERTY OWNER SHALL REMOVE AND RESET LIGHT POLE PRIOR AND AFTER BRIDGE CONSTRUCTION.
  - ALL DRAINAGE AND SANITARY SEWER WORK BY OTHERS (BO) SHALL BE INSTALLED BY CITY OF FITCHBURG, UNLESS OTHERWISE NOTED.
  - ALL GAS MAIN WORK BY OTHERS (BO) SHALL BE INSTALLED BY UNTIL GAS, UNLESS OTHERWISE NOTED.

**FITCHBURG**  
**ST 31 (RIVER STREET) OVER NORTH NASHUA RIVER**  
**NORTH FLOOD WALL DEMOLITION**  
**AND RECONSTRUCTION FOR OUTFALL PIPE**

|         |      |                         |           |              |
|---------|------|-------------------------|-----------|--------------|
| DATE    | REV. | DESCRIPTION             | SHEET NO. | TOTAL SHEETS |
| 10/1/20 | 1    | ISSUED FOR CONSTRUCTION | 41        | 100          |

PROJECT FILE NO. 607680

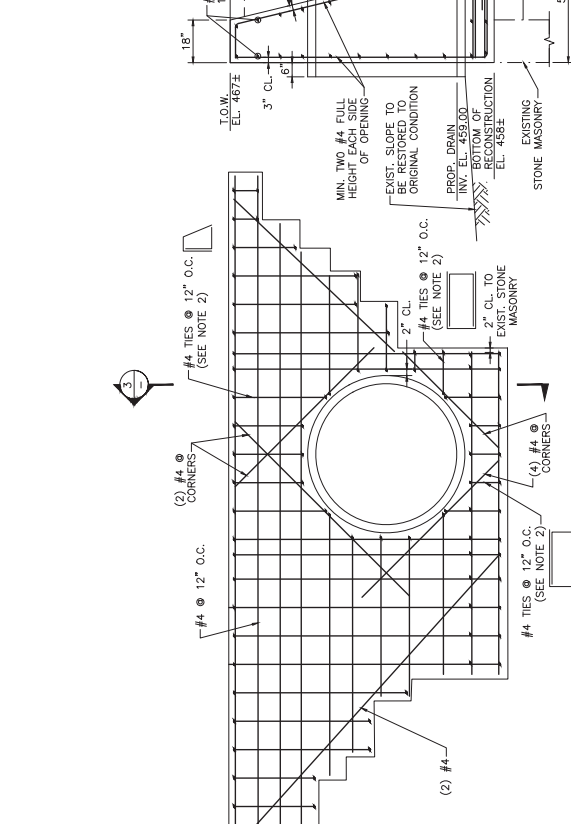

**PLAN**  
 SCALE: 1/4" = 1'-0"

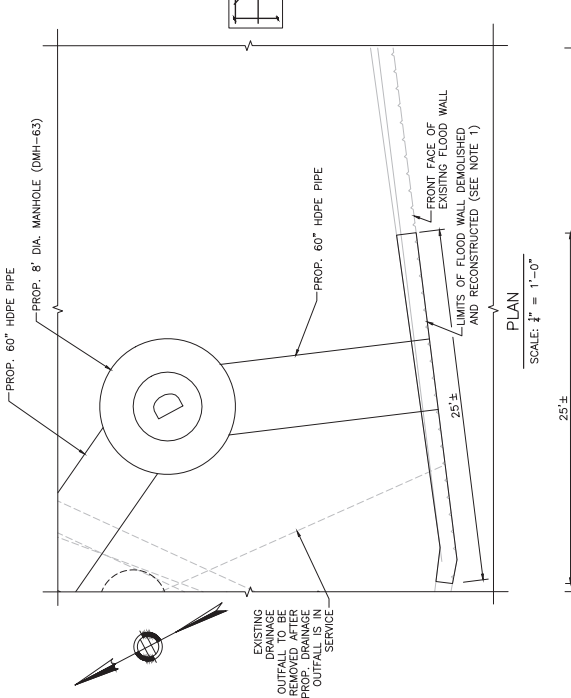

**ELEVATION - EXCAVATION LIMITS**  
 SCALE: 1/4" = 1'-0"



**PROPOSED RECONSTRUCTION ELEVATION**  
 SCALE: 1/4" = 1'-0"

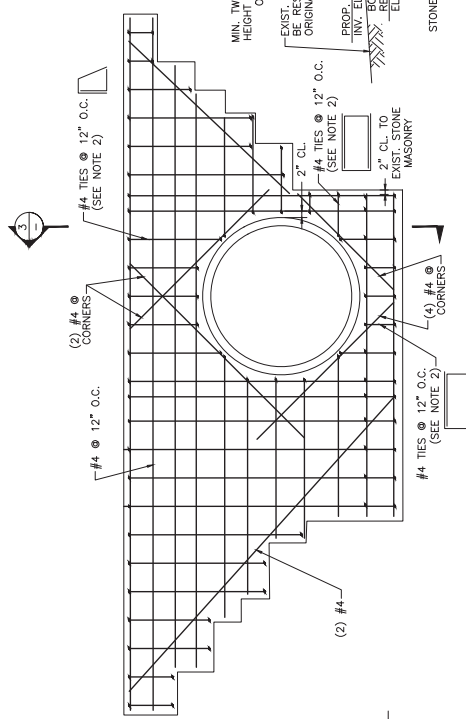

**ELEVATION - REINFORCING**  
 SCALE: 1/4" = 1'-0"

**SECTION 3**  
 SCALE: 1/4" = 1'-0"

**SECTION 4**  
 SCALE: 1/4" = 1'-0"

- NOTES:**
- LIMITS SHOWN ARE APPROXIMATE. LIMITS TO BE CONFIRMED IN FIELD BASED ON PRECONSTRUCTION SURVEY.
  - WHERE DIMENSIONS ARE TOO SMALL TO ALLOW FOR CLEAR COVER PLUS DEVELOPMENT OF STRAIGHT BARS, TIES SHALL BE USED.

**LEGEND:**

|          |                   |
|----------|-------------------|
| [Symbol] | BRIDGE            |
| [Symbol] | EXCAVATION        |
| [Symbol] | PROPOSED CONCRETE |

|      |  |
|------|--|
| DATE | ISSUED FOR CONSTRUCTION                            |
| DATE | THIS SHEET IS APPROVED FOR CONSTRUCTION BY MASSDOT |
| DATE | AUTHORIZED SIGNATURE OF SALESMAN                   |
| DATE | USE ONLY PRINTS OF LATEST DATE                     |

SHEET 17 OF 38 SHEETS BRIDGE NO. F-04-010 (1KR)



## **Attachment B**

### **Section 19 Documentation**

## **Historic and Tribal Consultation**

RC. 68186 JP  
RECEIVED  
NOV 18 2020  
MASS. HIST. COMM

950 CMR: OFFICE OF THE SECRETARY OF THE COMMONWEALTH

APPENDIX A  
MASSACHUSETTS HISTORICAL COMMISSION  
220 MORRISSEY BOULEVARD  
BOSTON, MASS. 02125  
617-727-8470, FAX: 617-727-5128

**PROJECT NOTIFICATION FORM**

**Project Name:** Replacement of Bridge F-04-010 (MassDOT-607680) After review of MHC files and the materials you submitted, it has been determined that this project is unlikely to affect significant historic or archaeological resources.

**Location /Address:** State Route 31 (River Street) over North Nashua River

**City/Town:** Fitchburg

**Project Proponent** RC. 68186

**Name:** Massachusetts Department of Transportation 11/20/20

**Address:** 10 Park Plaza Jonathan K. Patton  
Archaeologist / Preservation Planner Date

**City/Town/Zip/Telephone:** Boston, MA 02116 / T: 207-590-4999 Massachusetts Historical Commission

Agency license or funding for the project (list all licenses, permits, approvals, grants or other entitlements being sought from state and federal agencies).

**Agency Name**                      **Type of License or funding (specify)**

[MassDOT]                                      [State funding]

**Project Description (narrative):**

[MassDOT proposes to replace Bridge F-04-010, which carries State Route 31 (River Street) in Fitchburg over the North Nashua River. This bridge, constructed in 1952, consists of a two-span steel stringer superstructure supported on granite masonry abutments integral with river channel walls, and a single reinforced concrete pier. The project area includes the bridge structure itself and roadway approaches approximately 40' to the east and west of the bridge.

Proposed work includes replacement of the superstructure at the same width as existing, supported on the existing reinforced concrete pier, with new precast concrete integral abutments on pile footings set behind the existing stone masonry river channel walls. The proposed superstructure will consist of steel stringers with composite reinforced concrete deck, carrying two 12'-wide travel lanes with 5'-wide shoulders, and a 6.5'-wide sidewalk on either side. Painted three-rail steel S3-TL4 railings are proposed. The existing reinforced concrete bridge seats will be demolished down to the top of the stone masonry channel wall, to provide inspection access for the new bridge seats. Project work will also include full-depth pavement reconstruction; reconstruction of existing concrete sidewalks along the bridge approaches; minor side slope grading, resetting existing granite curbing, replacement of existing pavement markings and signage upgrades, improvements to existing catchbasins and drainage structures, installation of temporary erosion and sedimentation controls, and other related work. No work will take place in the river.

Construction will be phased, with a single northbound travel lane maintained for the duration. Southbound traffic will be detoured along West Street and Sheldon Street. One sidewalk will also be maintained and remain open during construction. ]

**Does the project include demolition?** Yes, the existing bridge will be demolished.

**Does the project include rehabilitation of any existing buildings?** N/A

**Does the project include new construction? If so, describe (attach plans and elevations if necessary).**

[Bridge F-04-010 will be removed and replaced on the same alignment with a structure of the same width. ]

950 CMR: OFFICE OF THE SECRETARY OF THE COMMONWEALTH

APPENDIX A (continued)

To the best of your knowledge, are any historic or archaeological properties known to exist within the project's area of potential impact? If so, specify.

Review of the State Register revealed one listed historic district adjacent to the bridge: Crocker Field (FIT.N). Crocker Field, dedicated in 1918 and expanded in 1924, is a community athletic field used by students in Fitchburg Public Schools for physical education and team sports. The Field complex is bounded by River Street on the north, Broad Street on the west, Circle Street on the south, and the North Nashua River on the east. The Field is enclosed by a wrought iron fence with concrete posts and kneewall. Proposed work will not disturb the boundary fence or other character-defining features of Crocker Field.

Review of the Inventory of Historic and Archaeological Assets of the Commonwealth revealed that Bridge F-04-010 is located adjacent to, but not located within, several inventoried areas, including: the Nashua River area (FIT.E) and the Fitchburg Upper Common area (FIT.C). The Nashua River area encompasses 18th and 19th century industries and mills along the river, the boundary of which follows the westerly sideline of River Street adjacent to Bridge F-04-010. The Fitchburg Upper Common area encompasses the 19th century city center surrounding the Upper Common, with a boundary line following the easterly sideline of River Street to include Crocker Field.

A review of MHC's archaeological base maps by Jameson Harwood, MassDOT Archaeologist, revealed no recorded historical or pre-Contact archaeological sites within or immediately adjacent to the project area. The nearest pre-Contact site in the vicinity of the project area is Site 19-WR-550 (Prehistoric Cluster #1), an undated flake scatter located 2.7 miles to the south, and well outside the current project's direct area of potential effect (APE). The proposed project work will be confined to disturbed and/or unfavorable areas within the existing City Layout, primarily within the existing roadway and bridge footprint and immediately adjacent disturbed areas. It is the opinion of the MassDOT Archaeologist that the APE has low sensitivity for significant archaeological resources based on the nature of the proposed work, the effects of past roadway and bridge construction, and nearby commercial development.

What is the total acreage of the project area?

|            |                          |       |                       |                          |       |
|------------|--------------------------|-------|-----------------------|--------------------------|-------|
| Woodland   | <u>  </u>   <u>  </u>    | acres | Productive Resources: |                          |       |
| Wetland    | <u>  </u>   <u>  </u>    | acres | Agriculture           | <u>  </u>   <u>  </u>    | acres |
| Floodplain | <u>  </u>   <u>  </u>    | acres | Forestry              | <u>  </u>   <u>  </u>    | acres |
| Open Space | <u>  </u>   <u>  </u>    | acres | Mining/Extraction     | <u>  </u>   <u>  </u>    | acres |
| Developed  | <u>&lt;1</u>   <u>  </u> | acres | Total Project Acreage | <u>&lt;1</u>   <u>  </u> | acres |

What is the acreage of the proposed new construction? <1 |    acres

What is the present land use of the project area?

Proposed work will take place within the existing bridge and roadway footprint and immediately adjacent disturbed areas within the existing City Layout.

Please attach a copy of the section of the USGS quadrangle map which clearly marks the project location. This Project Notification Form has been submitted to the MHC in compliance with 950 CMR 71.00.

Signature of person submitting this form: Kurt Jergensen Date: 11/16/2020

Name: Kurt Jergensen

Address: MassDOT, 10 Park Plaza, Room 4260

City/Town/Zip: Boston, MA 02116

Telephone: 207-590-4999 (cell)



950 CMR: OFFICE OF THE SECRETARY OF THE COMMONWEALTH

APPENDIX A  
 MASSACHUSETTS HISTORICAL COMMISSION  
 220 MORRISSEY BOULEVARD  
 BOSTON, MASS. 02125  
 617-727-8470, FAX: 617-727-5128  
PROJECT NOTIFICATION FORM

**Project Name:** Replacement of Bridge F-04-010 (MassDOT 607680)  
**Location /Address:** State Route 31 (River Street) over North Nashua River  
**City/Town:** Fitchburg  
**Project Proponent**  
**Name:** Massachusetts Department of Transportation  
**Address:** 10 Park Plaza  
**City/Town/Zip/Telephone:** Boston, MA 02116 / T: 207-590-4999

Agency license or funding for the project (list all licenses, permits, approvals, grants or other entitlements being sought from state and federal agencies).

| <u>Agency Name</u>         | <u>Type of License or funding (specify)</u> |
|----------------------------|---|
| US Army Corps of Engineers | Section 404 permit                          |
| MassDOT                    | State funding                               |

**Project Description (narrative):**

MassDOT proposes to replace Bridge F-04-010, which carries State Route 31 (River Street) in Fitchburg over the North Nashua River. This bridge, constructed in 1952, consists of a two-span steel stringer superstructure supported on granite masonry abutments integral with river channel walls, and a single reinforced concrete pier. The project area includes the bridge structure itself and roadway approaches approximately 40' to the east and west of the bridge.

Proposed work includes replacement of the superstructure at the same width as existing, supported on the existing reinforced concrete pier, with new precast concrete integral abutments on pile footings set behind the existing stone masonry river channel walls. The proposed superstructure will consist of steel stringers with composite reinforced concrete deck, carrying two 12'-wide travel lanes with 5'-wide shoulders, and a 6.5'-wide sidewalk on either side. Painted three-rail steel S3-TL4 railings are proposed. The existing reinforced concrete bridge seats will be demolished down to the top of the stone masonry channel wall, to provide inspection access for the new bridge seats. Project work will also include full-depth pavement reconstruction; reconstruction of existing concrete sidewalks along the bridge approaches; minor side slope grading, resetting existing granite curbing, replacement of existing pavement markings and signage upgrades, improvements to existing catchbasins and drainage structures, installation of temporary erosion and sedimentation controls, and other related work.

A temporary utility bridge will also be installed immediately to the north of the bridge. This 5'-wide prefabricated truss structure will be set on timber crane support matting at-grade, and will be removed once bridge construction is complete.

Construction will be phased, with a single northbound travel lane maintained for the duration. Southbound traffic will be detoured along West Street and Sheldon Street. One sidewalk will also be maintained and remain open during construction.

950 CMR: OFFICE OF THE SECRETARY OF THE COMMONWEALTH

APPENDIX A (continued)

**Does the project include demolition?** Yes, the existing bridge will be demolished.

**Does the project include rehabilitation of any existing buildings?** N/A

**Does the project include new construction? If so, describe (attach plans and elevations if necessary).**

[Bridge F-04-010 will be removed and replaced on the same alignment with a structure of the same width. ]

**To the best of your knowledge, are any historic or archaeological properties known to exist within the project's area of potential impact? If so, specify.**

[Review of the State Register revealed one listed historic district adjacent to the bridge: Crocker Field (FIT.N). Crocker Field, dedicated in 1918 and expanded in 1924, is a community athletic field used by students in Fitchburg Public Schools for physical education and team sports. The Field complex is bounded by River Street on the north, Broad Street on the west, Circle Street on the south, and the North Nashua River on the east. The Field is enclosed by a wrought iron fence with concrete posts and kneewall. Proposed work will not disturb the boundary fence or other character-defining features of Crocker Field.

Review of the Inventory of Historic and Archaeological Assets of the Commonwealth revealed that Bridge F-04-010 is located adjacent to, but not located within, several inventoried areas, including: the Nashua River area (FIT.E) and the Fitchburg Upper Common area (FIT.C). The Nashua River area encompasses 18th and 19th century industries and mills along the river, the boundary of which follows the westerly sideline of River Street adjacent to Bridge F-04-010. The Fitchburg Upper Common area encompasses the 19th century city center surrounding the Upper Common, with a boundary line following the easterly sideline of River Street to include Crocker Field.

A review of MHC's archaeological base maps by Jameson Harwood, MassDOT Archaeologist, revealed no recorded historical or pre-Contact archaeological sites within or immediately adjacent to the project area. The nearest pre-Contact site in the vicinity of the project area is Site 19-WR-550 (Prehistoric Cluster #1), an undated flake scatter located 2.7 miles to the south, and well outside the current project's direct area of potential effect (APE). The proposed project work will be confined to disturbed and/or unfavorable areas within the existing City Layout, primarily within the existing roadway and bridge footprint and immediately adjacent disturbed areas. It is the opinion of the MassDOT Archaeologist that the APE has low sensitivity for significant archaeological resources based on the nature of the proposed work, the effects of past roadway and bridge construction, and nearby commercial development.]

**What is the total acreage of the project area?**

|            |       |       |                       |       |       |
|------------|-------|-------|-----------------------|-------|-------|
| Woodland   | _____ | acres | Productive Resources: |       |       |
| Wetland    | _____ | acres | Agriculture           | _____ | acres |
| Floodplain | _____ | acres | Forestry              | _____ | acres |
| Open Space | _____ | acres | Mining/Extraction     | _____ | acres |
| Developed  | <1    | acres | Total Project Acreage | <1    | acres |

**What is the acreage of the proposed new construction?**

\_\_\_\_\_ <1 acres

**What is the present land use of the project area?**

[Proposed work will take place within the existing bridge and roadway footprint and immediately adjacent disturbed areas within the existing City Layout.

**Please attach a copy of the section of the USGS quadrangle map which clearly marks the project location.**

950 CMR: OFFICE OF THE SECRETARY OF THE COMMONWEALTH

APPENDIX A (continued)

This Project Notification Form has been submitted to the MHC in compliance with 950 CMR 71.00.

Signature of person submitting this form: *Kurt Jergensen* Date: 6/16/2023

Name: Kurt Jergensen

Address: MassDOT, 10 Park Plaza, Room 4260

City/Town/Zip: Boston, MA 02116

Telephone: 207-590-4999 (cell)

REGULATORY AUTHORITY

950 CMR 71.00: M.G.L. c. 9, §§ 26-27C as amended by St. 1988, c. 254.

7/1/93

950 CMR - 276

[[

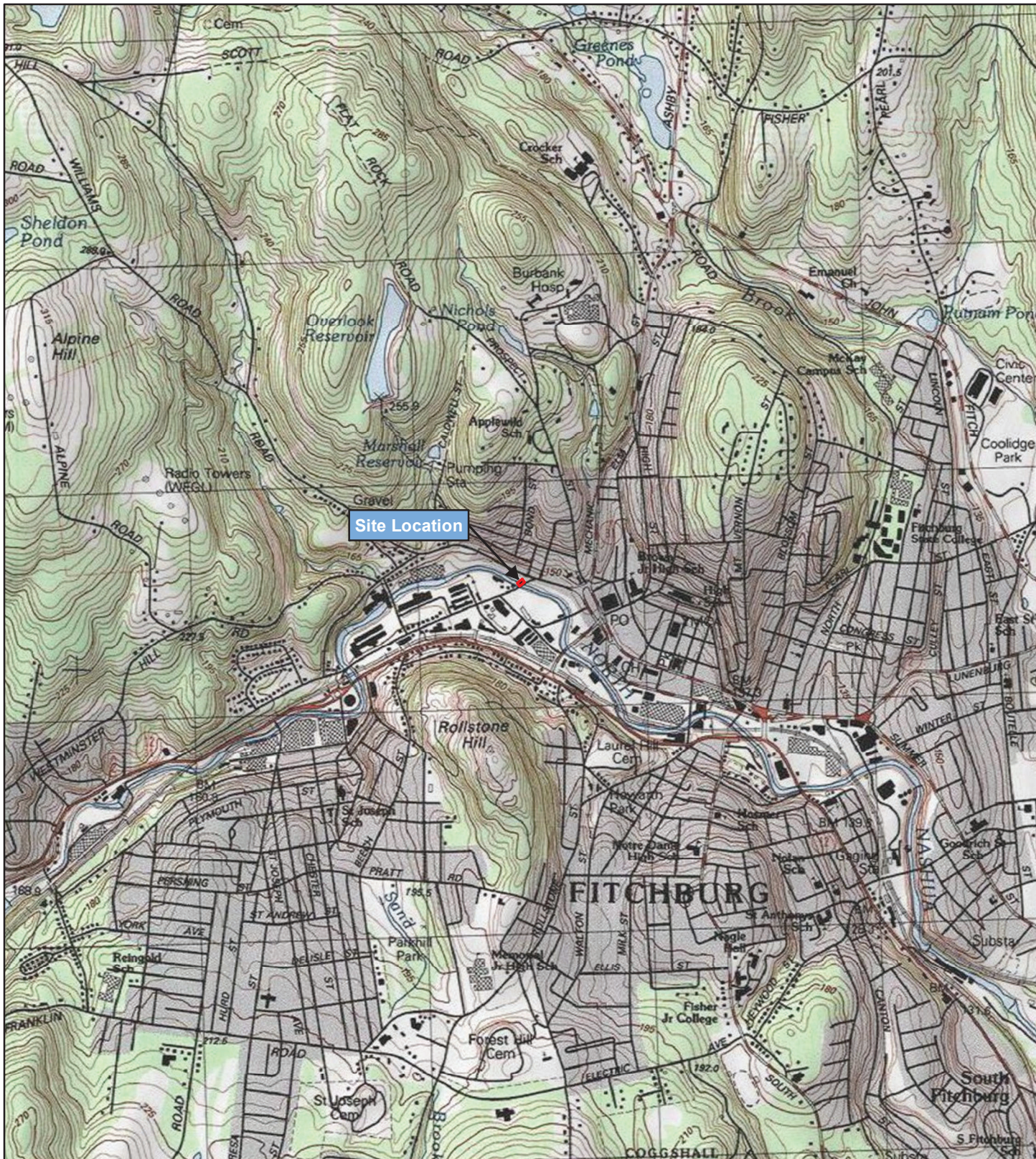

 Approximate Site Location Boundary



Wannalancit Mills  
650 Suffolk Street  
Lowell, MA 01854  
978-970-5600



**SITE LOCUS**  
**RIVER STREET BRIDGE**  
**REPLACEMENT PROJECT**  
**FITCHBURG, MA**

Source Data: MassGIS, 2020  
Base Map: Copyright:© 2013  
National Geographic Society, i-cubed

FIGURE 1 | FEBRUARY 2020

**Jergensen, Kurt E. (DOT)**

---

**From:** Jergensen, Kurt E. (DOT)  
**Sent:** Wednesday, June 14, 2023 4:26 PM  
**To:** Bettina Washington  
**Cc:** tcrm2@wampanoagtribe-nsn.gov; Harwood, Jameson (DOT)  
**Subject:** Fitchburg, Br. F-04-010 replacement (MassDOT #607680)  
**Attachments:** F-04-010 PNF.pdf; Locus Map.pdf; 607680\_Fitchburg 100% Highway Plans.pdf; 607680\_Fitchburg 2nd Submission Bridge Plans.pdf

Dear Ms. Washington,

MassDOT is submitting the enclosed information regarding the above-noted project to the Wampanoag Tribe of Gay Head (Aquinnah) to meet the Section 106 consultation requirements of the US Army Corps of Engineers (as Lead Federal Agency). Please submit any written comments or concerns regarding historic or archaeological properties that may be affected by this project to Carrie Lavallee, P.E., Chief Engineer, Massachusetts Department of Transportation, 10 Park Plaza, Boston, MA 02116-3973, Attn: Jameson Harwood.

You also may send comments, questions, or requests for more information by email to [Jameson.Harwood@state.ma.us](mailto:Jameson.Harwood@state.ma.us).

Thank you very much.

Kurt Jergensen  
Historic Bridge Specialist  
Environmental Services  
MassDOT, Highway Division  
Ten Park Plaza, Boston, MA 02116  
Cell: 207-590-4999

**Jergensen, Kurt E. (DOT)**

---

**From:** postmaster@MassMail.State.MA.US  
**To:** tcrm2@wampanoagtribe-nsn.gov; Bettina Washington  
**Sent:** Wednesday, June 14, 2023 4:27 PM  
**Subject:** Relayed: Fitchburg, Br. F-04-010 replacement (MassDOT #607680)

**Delivery to these recipients or groups is complete, but no delivery notification was sent by the destination server:**

[tcrm2@wampanoagtribe-nsn.gov](mailto:tcrm2@wampanoagtribe-nsn.gov) ([tcrm2@wampanoagtribe-nsn.gov](mailto:tcrm2@wampanoagtribe-nsn.gov))

[Bettina Washington](mailto:thpo@wampanoagtribe-nsn.gov) ([thpo@wampanoagtribe-nsn.gov](mailto:thpo@wampanoagtribe-nsn.gov))

Subject: Fitchburg, Br. F-04-010 replacement (MassDOT #607680)



Fitchburg, Br.  
F-04-010 replac...

**Jergensen, Kurt E. (DOT)**

---

**From:** Jergensen, Kurt E. (DOT)  
**Sent:** Wednesday, June 14, 2023 4:33 PM  
**To:** David Weeden  
**Cc:** 106Review@mwtribe-nsn.gov; Harwood, Jameson (DOT)  
**Subject:** Fitchburg, Br. F-04-010 replacement (MassDOT #607680)  
**Attachments:** F-04-010 PNF.pdf; Locus Map.pdf; 607680\_Fitchburg 100% Highway Plans.pdf; 607680\_Fitchburg 2nd Submission Bridge Plans.pdf

Dear Mr. Weeden,

MassDOT is submitting the enclosed information regarding the above-noted project to the Mashpee Wampanoag Tribe to meet the Section 106 consultation requirements of the US Army Corps of Engineers (as Lead Federal Agency). Please submit any written comments or concerns regarding historic or archaeological properties that may be affected by this project to Carrie Lavallee, P.E., Chief Engineer, Massachusetts Department of Transportation, 10 Park Plaza, Boston, MA 02116-3973, Attn: Jameson Harwood.

You also may send comments, questions, or requests for more information by email to [Jameson.Harwood@state.ma.us](mailto:Jameson.Harwood@state.ma.us).

Thank you very much.

Kurt Jergensen  
Historic Bridge Specialist  
Environmental Services  
MassDOT, Highway Division  
Ten Park Plaza, Boston, MA 02116  
Cell: 207-590-4999

**Jergensen, Kurt E. (DOT)**

---

**From:** postmaster@MassMail.State.MA.US  
**To:** 106Review@mwtribe-nsn.gov; David Weeden  
**Sent:** Wednesday, June 14, 2023 4:33 PM  
**Subject:** Relayed: Fitchburg, Br. F-04-010 replacement (MassDOT #607680)

**Delivery to these recipients or groups is complete, but no delivery notification was sent by the destination server:**

[106Review@mwtribe-nsn.gov](mailto:106Review@mwtribe-nsn.gov) ([106Review@mwtribe-nsn.gov](mailto:106Review@mwtribe-nsn.gov))

[David Weeden](mailto:David.Weeden@mwtribe-nsn.gov) ([David.Weeden@mwtribe-nsn.gov](mailto:David.Weeden@mwtribe-nsn.gov))

Subject: Fitchburg, Br. F-04-010 replacement (MassDOT #607680)



Fitchburg, Br.  
F-04-010 replac...



**Jergensen, Kurt E. (DOT)**

---

**From:** Jergensen, Kurt E. (DOT)  
**Sent:** Wednesday, June 14, 2023 4:31 PM  
**To:** Tashtesook@aol.com  
**Cc:** Harwood, Jameson (DOT)  
**Subject:** Fitchburg, Br. F-04-010 replacement (MassDOT #607680)  
**Attachments:** F-04-010 PNF.pdf; Locus Map.pdf; 607680\_Fitchburg 100% Highway Plans.pdf; 607680\_Fitchburg 2nd Submission Bridge Plans.pdf

Dear Mr. Brown,

MassDOT is submitting the enclosed information regarding the above-noted project to the Narragansett Indian Tribe to meet the Section 106 consultation requirements of the US Army Corps of Engineers (as Lead Federal Agency). Please submit any written comments or concerns regarding historic or archaeological properties that may be affected by this project to Carrie Lavallee, P.E., Chief Engineer, Massachusetts Department of Transportation, 10 Park Plaza, Boston, MA 02116-3973, Attn: Jameson Harwood.

You also may send comments, questions, or requests for more information by email to [Jameson.Harwood@state.ma.us](mailto:Jameson.Harwood@state.ma.us).

Thank you very much.

Kurt Jergensen  
Historic Bridge Specialist  
Environmental Services  
MassDOT, Highway Division  
Ten Park Plaza, Boston, MA 02116  
Cell: 207-590-4999

**Jergensen, Kurt E. (DOT)**

---

**From:** postmaster@MassMail.State.MA.US  
**To:** Tashtesook@aol.com  
**Sent:** Wednesday, June 14, 2023 4:31 PM  
**Subject:** Relayed: Fitchburg, Br. F-04-010 replacement (MassDOT #607680)

**Delivery to these recipients or groups is complete, but no delivery notification was sent by the destination server:**

[Tashtesook@aol.com](mailto:Tashtesook@aol.com) ([Tashtesook@aol.com](mailto:Tashtesook@aol.com))

Subject: Fitchburg, Br. F-04-010 replacement (MassDOT #607680)



Fitchburg, Br.  
F-04-010 replac...

**Jergensen, Kurt E. (DOT)**

---

**From:** Jergensen, Kurt E. (DOT)  
**Sent:** Wednesday, June 14, 2023 4:34 PM  
**To:** Robinson, David S (EEA)  
**Cc:** Harwood, Jameson (DOT)  
**Subject:** Fitchburg, Br. F-04-010 replacement (MassDOT #607680)  
**Attachments:** F-04-010 PNF.pdf; Locus Map.pdf; 607680\_Fitchburg 100% Highway Plans.pdf; 607680\_Fitchburg 2nd Submission Bridge Plans.pdf

Dear Mr. Robinson,

MassDOT is submitting the enclosed information regarding the above-noted project to the Board of Underwater Archaeological Resources to meet the Section 106 consultation requirements of the US Army Corps of Engineers (as Lead Federal Agency). Please submit any written comments or concerns regarding historic or archaeological properties that may be affected by this project to Carrie Lavallee, P.E., Chief Engineer, Massachusetts Department of Transportation, 10 Park Plaza, Boston, MA 02116-3973, Attn: Jameson Harwood.

You also may send comments, questions, or requests for more information by email to [Jameson.Harwood@state.ma.us](mailto:Jameson.Harwood@state.ma.us).

Thank you very much.

Kurt Jergensen  
Historic Bridge Specialist  
Environmental Services  
MassDOT, Highway Division  
Ten Park Plaza, Boston, MA 02116  
Cell: 207-590-4999

**Jergensen, Kurt E. (DOT)**

---

**From:** Microsoft Outlook  
**To:** Robinson, David S (EEA)  
**Sent:** Wednesday, June 14, 2023 4:34 PM  
**Subject:** Delivered: Fitchburg, Br. F-04-010 replacement (MassDOT #607680)

**Your message has been delivered to the following recipients:**

[Robinson, David S \(EEA\) \(David.S.Robinson@mass.gov\)](mailto:David.S.Robinson@mass.gov)

Subject: Fitchburg, Br. F-04-010 replacement (MassDOT #607680)



Fitchburg, Br.  
F-04-010 replac...

## **Threatened & Endangered Species**



## United States Department of the Interior



FISH AND WILDLIFE SERVICE  
New England Ecological Services Field Office  
70 Commercial Street, Suite 300  
Concord, NH 03301-5094  
Phone: (603) 223-2541 Fax: (603) 223-0104

In Reply Refer To:  
Project Code: 2023-0068776  
Project Name: River Street Bridge Replacement

April 13, 2023

Subject: List of threatened and endangered species that may occur in your proposed project location or may be affected by your proposed project

To Whom It May Concern:

*Updated 3/8/2023 - Please review this letter each time you request an Official Species List, we will continue to update it with additional information and links to websites may change.*

### **About Official Species Lists**

The purpose of the Act is to provide a means whereby threatened and endangered species and the ecosystems upon which they depend may be conserved. Federal and non-Federal project proponents have responsibilities under the Act to consider effects on listed species.

The enclosed species list identifies threatened, endangered, proposed, and candidate species, as well as proposed and final designated critical habitat, that may occur within the boundary of your proposed project and/or may be affected by your proposed project. The species list fulfills the requirements of the U.S. Fish and Wildlife Service (Service) under section 7(c) of the Endangered Species Act (Act) of 1973, as amended (16 U.S.C. 1531 et seq.).

New information based on updated surveys, changes in the abundance and distribution of species, changed habitat conditions, or other factors could change this list. Please note that under 50 CFR 402.12(e) of the regulations implementing section 7 of the Act, the accuracy of this species list should be verified after 90 days. The Service recommends that verification be completed by visiting the ECOS-IPaC website at regular intervals during project planning and implementation for updates to species lists and information. An updated list may be requested by returning to an existing project's page in IPaC.

### **Endangered Species Act Project Review**

Please visit the “**New England Field Office Endangered Species Project Review and Consultation**” website for step-by-step instructions on how to consider effects on listed

species and prepare and submit a project review package if necessary:

<https://www.fws.gov/office/new-england-ecological-services/endangered-species-project-review>

**\*NOTE\*** Please do not use the **Consultation Package Builder** tool in IPaC except in specific situations following coordination with our office. Please follow the project review guidance on our website instead and reference your **Project Code** in all correspondence.

**Northern Long-eared Bat - (Updated 3/8/2023)** The Service published a final rule to reclassify the northern long-eared bat (NLEB) as endangered on November 30, 2022. The final rule will go into effect on **March 31, 2023**. After that date, the current 4(d) rule for NLEB will be invalid, and the 4(d) determination key will no longer be available. New compliance tools will be available in March 2023, and information will be posted in this section on our website and on the northern long-eared bat species page, so please check this site often for updates.

Depending on the type of effects a project has on NLEB, the change in the species' status may trigger the need to re-initiate consultation for any actions that are not completed and for which the Federal action agency retains discretion once the new listing determination becomes effective. If your project may result in incidental take of NLEB after the new listing goes into effect, this will need to be addressed in an updated consultation that includes an Incidental Take Statement. Many of these situations will be addressed through the new compliance tools. If your project may require re-initiation of consultation, please wait for information on the new tools to appear on this site or contact our office for additional guidance.

#### *Additional Info About Section 7 of the Act*

Under section 7(a)(2) of the Act and its implementing regulations (50 CFR 402 et seq.), Federal agencies are required to determine whether projects may affect threatened and endangered species and/or designated critical habitat. If a Federal agency, or its non-Federal representative, determines that listed species and/or designated critical habitat may be affected by the proposed project, the agency is required to consult with the Service pursuant to 50 CFR 402. In addition, the Federal agency also may need to consider proposed species and proposed critical habitat in the consultation. 50 CFR 402.14(c)(1) specifies the information required for consultation under the Act regardless of the format of the evaluation. More information on the regulations and procedures for section 7 consultation, including the role of permit or license applicants, can be found in the "Endangered Species Consultation Handbook" at:

<https://www.fws.gov/service/section-7-consultations>

In addition to consultation requirements under Section 7(a)(2) of the ESA, please note that under sections 7(a)(1) of the Act and its implementing regulations (50 CFR 402 et seq.), Federal agencies are required to utilize their authorities to carry out programs for the conservation of threatened and endangered species. Please contact NEFO if you would like more information.

**Candidate species** that appear on the enclosed species list have no current protections under the ESA. The species' occurrence on an official species list does not convey a requirement to

consider impacts to this species as you would a proposed, threatened, or endangered species. The ESA does not provide for interagency consultations on candidate species under section 7, however, the Service recommends that all project proponents incorporate measures into projects to benefit candidate species and their habitats wherever possible.

### **Migratory Birds**

In addition to responsibilities to protect threatened and endangered species under the Endangered Species Act (ESA), there are additional responsibilities under the Migratory Bird Treaty Act (MBTA) and the Bald and Golden Eagle Protection Act (BGEPA) to protect native birds from project-related impacts. Any activity, intentional or unintentional, resulting in take of migratory birds, including eagles, is prohibited unless otherwise permitted by the U.S. Fish and Wildlife Service (50 C.F.R. Sec. 10.12 and 16 U.S.C. Sec. 668(a)). For more information regarding these Acts see:

<https://www.fws.gov/program/migratory-bird-permit>

<https://www.fws.gov/library/collections/bald-and-golden-eagle-management>

Please feel free to contact us at **newengland@fws.gov** with your **Project Code** in the subject line if you need more information or assistance regarding the potential impacts to federally proposed, listed, and candidate species and federally designated and proposed critical habitat.

Attachment(s): Official Species List

Attachment(s):

- Official Species List



## **OFFICIAL SPECIES LIST**

This list is provided pursuant to Section 7 of the Endangered Species Act, and fulfills the requirement for Federal agencies to "request of the Secretary of the Interior information whether any species which is listed or proposed to be listed may be present in the area of a proposed action".

This species list is provided by:

**New England Ecological Services Field Office**

70 Commercial Street, Suite 300

Concord, NH 03301-5094

(603) 223-2541

## PROJECT SUMMARY

Project Code: 2023-0068776  
 Project Name: River Street Bridge Replacement  
 Project Type: Culvert Repair/Replacement/Maintenance  
 Project Description: Replacement of the existing River Street Bridge over the North Nashua River and the replacement of an adjacent culvert carrying stormwater outfall.

### Project Location:

The approximate location of the project can be viewed in Google Maps: <https://www.google.com/maps/@42.586955,-71.80879696909344,14z>

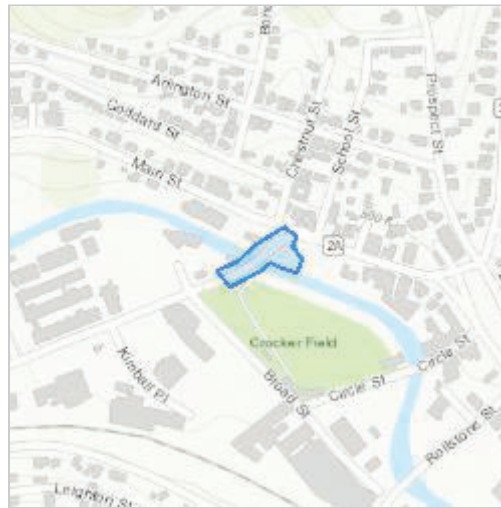

Counties: Worcester County, Massachusetts

## ENDANGERED SPECIES ACT SPECIES

There is a total of 2 threatened, endangered, or candidate species on this species list.

Species on this list should be considered in an effects analysis for your project and could include species that exist in another geographic area. For example, certain fish may appear on the species list because a project could affect downstream species.

IPaC does not display listed species or critical habitats under the sole jurisdiction of NOAA Fisheries<sup>1</sup>, as USFWS does not have the authority to speak on behalf of NOAA and the Department of Commerce.

See the "Critical habitats" section below for those critical habitats that lie wholly or partially within your project area under this office's jurisdiction. Please contact the designated FWS office if you have questions.

- 
1. [NOAA Fisheries](#), also known as the National Marine Fisheries Service (NMFS), is an office of the National Oceanic and Atmospheric Administration within the Department of Commerce.

## MAMMALS

| NAME   | STATUS     |
|--|------------|
| Northern Long-eared Bat <i>Myotis septentrionalis</i><br>No critical habitat has been designated for this species.<br>Species profile: <a href="https://ecos.fws.gov/ecp/species/9045">https://ecos.fws.gov/ecp/species/9045</a> | Endangered |

## INSECTS

| NAME   | STATUS    |
|--|-----------|
| Monarch Butterfly <i>Danaus plexippus</i><br>No critical habitat has been designated for this species.<br>Species profile: <a href="https://ecos.fws.gov/ecp/species/9743">https://ecos.fws.gov/ecp/species/9743</a> | Candidate |

## CRITICAL HABITATS

THERE ARE NO CRITICAL HABITATS WITHIN YOUR PROJECT AREA UNDER THIS OFFICE'S JURISDICTION.

## **IPAC USER CONTACT INFORMATION**

Agency: TRC  
Name: Gregory Russo  
Address: 650 Suffolk Street  
Address Line 2: Suite 200  
City: Lowell  
State: MA  
Zip: 01854  
Email: grusso@trccompanies.com  
Phone: 9789415834



## United States Department of the Interior



FISH AND WILDLIFE SERVICE  
New England Ecological Services Field Office  
70 Commercial Street, Suite 300  
Concord, NH 03301-5094  
Phone: (603) 223-2541 Fax: (603) 223-0104

In Reply Refer To:

January 03, 2023

Project code: 2023-0027663

Project Name: 607680 - FITCHBURG- BRIDGE REHABILITATION, F-04-010, RIVER STREET (ST 31) OVER NORTH NASHUA RIVER

Subject: Concurrence verification letter for the '607680 - FITCHBURG- BRIDGE REHABILITATION, F-04-010, RIVER STREET (ST 31) OVER NORTH NASHUA RIVER' project under the revised February 5, 2018, FHWA, FRA, FTA Programmatic Biological Opinion for Transportation Projects within the Range of the Indiana Bat and Northern Long-eared Bat.

To whom it may concern:

The U.S. Fish and Wildlife Service (Service) has received your request dated January 03, 2023 to verify that the **607680 - FITCHBURG- BRIDGE REHABILITATION, F-04-010, RIVER STREET (ST 31) OVER NORTH NASHUA RIVER** (Proposed Action) may rely on the concurrence provided in the February 5, 2018, FHWA, FRA, FTA Programmatic Biological Opinion for Transportation Projects within the Range of the Indiana Bat and Northern Long-eared Bat (PBO) to satisfy requirements under Section 7(a)(2) of the Endangered Species Act of 1973 (ESA) (87 Stat. 884, as amended; 16 U.S.C 1531 *et seq.*).

Based on the information you provided (Project Description shown below), you have determined that the Proposed Action is within the scope and adheres to the criteria of the PBO, including the adoption of applicable avoidance and minimization measures, and may affect, but is not likely to adversely affect (NLAA) the endangered Indiana bat (*Myotis sodalis*) and/or the threatened Northern long-eared bat (*Myotis septentrionalis*). Consultation with the Service pursuant to Section 7(a)(2) of the Endangered Species Act of 1973 (ESA) (87 Stat. 884, as amended; 16 U.S.C. 1531 *et seq.*) is required.

The Service has 14 calendar days to notify the lead Federal action agency or designated non-federal representative if we determine that the Proposed Action does not meet the criteria for a NLAA determination under the PBO. If we do not notify the lead Federal action agency or designated non-federal representative within that timeframe, you may proceed with the Proposed Action under the terms of the NLAA concurrence provided in the PBO. This verification period allows Service Field Offices to apply local knowledge to implementation of the PBO, as we may

identify a small subset of actions having impacts that were unanticipated. In such instances, Service Field Offices may request additional information that is necessary to verify inclusion of the proposed action under the PBO.

NOTE: The Service reclassified the NLEB as an endangered species on November 30, 2022. This ruling becomes effective on January 30, 2023. This NLAA determination does not require reinitiation. For projects requiring consultation after the effective date of January 30, 2023, please use the 2022 FHWA, FRA, FTA PBO.

**For Proposed Actions that include bridge/culvert or structure removal, replacement, and/or maintenance activities:** If your initial bridge/culvert or structure assessment documented signs of bat use or occupancy, or an assessment failed to detect Indiana bats and/or NLEBs, yet are later detected prior to, or during construction, please submit the Post Assessment Discovery of Bats at Bridge/Culvert or Structure Form (User Guide Appendix E) to this Service Office within 2 working days of any potential take. In these instances, potential incidental take of Indiana bats and/or NLEBs is covered under the Incidental Take Statement in the 2018 FHWA, FRA, FTA PBO (provided that the take is reported to the Service).

If the Proposed Action is modified, or new information reveals that it may affect the Indiana bat and/or Northern long-eared bat in a manner or to an extent not considered in the PBO, further review to conclude the requirements of ESA Section 7(a)(2) may be required. If the Proposed Action may affect any other federally-listed or proposed species, and/or any designated critical habitat, additional consultation between the lead Federal action agency and this Service Office is required. If the proposed action has the potential to take bald or golden eagles, additional coordination with the Service under the Bald and Golden Eagle Protection Act may also be required. In either of these circumstances, please contact this Service Office.

The following species may occur in your project area and **are not** covered by this determination:

- Monarch Butterfly *Danaus plexippus* Candidate

## **Project Description**

The following project name and description was collected in IPaC as part of the endangered species review process.

### ***Name***

607680 - FITCHBURG- BRIDGE REHABILITATION, F-04-010, RIVER STREET (ST 31)  
OVER NORTH NASHUA RIVER

### ***Description***

607680 - FITCHBURG- BRIDGE REHABILITATION, F-04-010, RIVER STREET (ST 31)  
OVER NORTH NASHUA RIVER  
Work consists of rehabbing F-04-010.  
Monarch Butterfly: Candidate Species only, no conservation measures at this time.

## Determination Key Result

Based on your answers provided, this project(s) may affect, but is not likely to adversely affect the endangered Indiana bat and/or the threatened Northern long-eared bat, therefore, consultation with the U.S. Fish and Wildlife Service pursuant to Section 7(a)(2) of the Endangered Species Act of 1973 (ESA) (87 Stat. 884, as amended 16 U.S.C. 1531 *et seq.*) is required. However, also based on your answers provided, this project may rely on the concurrence provided in the revised February 5, 2018, FHWA, FRA, FTA Programmatic Biological Opinion for Transportation Projects within the Range of the Indiana Bat and Northern Long-eared Bat.

## Qualification Interview

1. Is the project within the range of the Indiana bat<sup>[1]</sup>?

[1] See [Indiana bat species profile](#)

**Automatically answered**

No

2. Is the project within the range of the Northern long-eared bat<sup>[1]</sup>?

[1] See [Northern long-eared bat species profile](#)

**Automatically answered**

Yes

3. Which Federal Agency is the lead for the action?

A) *Federal Highway Administration (FHWA)*

4. Are *all* project activities limited to non-construction<sup>[1]</sup> activities only? (examples of non-construction activities include: bridge/abandoned structure assessments, surveys, planning and technical studies, property inspections, and property sales)

[1] Construction refers to activities involving ground disturbance, percussive noise, and/or lighting.

No

5. Does the project include *any* activities that are **greater than** 300 feet from existing road/rail surfaces<sup>[1]</sup>?

[1] Road surface is defined as the actively used [e.g. motorized vehicles] driving surface and shoulders [may be pavement, gravel, etc.] and rail surface is defined as the edge of the actively used rail ballast.

No

6. Does the project include *any* activities **within** 0.5 miles of a known Indiana bat and/or NLEB hibernaculum<sup>[1]</sup>?

[1] For the purpose of this consultation, a hibernaculum is a site, most often a cave or mine, where bats hibernate during the winter (see suitable habitat), but could also include bridges and structures if bats are found to be hibernating there during the winter.

No

7. Is the project located **within** a karst area?

No



8. Is there *any* suitable<sup>[1]</sup> summer habitat for Indiana Bat or NLEB **within** the project action area<sup>[2]</sup>? (includes any trees suitable for maternity, roosting, foraging, or travelling habitat)

[1] See the Service's [summer survey guidance](#) for our current definitions of suitable habitat.

[2] The action area is defined as all areas to be affected directly or indirectly by the Federal action and not merely the immediate area involved in the action (50 CFR Section 402.02). Further clarification is provided by the [User's Guide for the Range-wide Programmatic Consultation for Indiana Bat and Northern Long-eared Bat](#).

Yes

9. Will the project remove *any* suitable summer habitat<sup>[1]</sup> and/or remove/trim any existing trees **within** suitable summer habitat?

[1] See the Service's [summer survey guidance](#) for our current definitions of suitable habitat.

Yes

10. Will the project clear more than 20 acres of suitable habitat per 5-mile section of road/rail?  
No

11. Have presence/probable absence (P/A) summer surveys<sup>[1][2]</sup> been conducted<sup>[3][4]</sup> **within** the suitable habitat located within your project action area?

[1] See the Service's [summer survey guidance](#) for our current definitions of suitable habitat.

[2] Presence/probable absence summer surveys conducted within the fall swarming/spring emergence home range of a documented Indiana bat hibernaculum (contact local Service Field Office for appropriate distance from hibernacula) that result in a negative finding requires additional consultation with the local Service Field Office to determine if clearing of forested habitat is appropriate and/or if seasonal clearing restrictions are needed to avoid and minimize potential adverse effects on fall swarming and spring emerging Indiana bats.

[3] For projects within the range of either the Indiana bat or NLEB in which suitable habitat is present, and no bat surveys have been conducted, the transportation agency will assume presence of the appropriate species. This assumption of presence should be based upon the presence of suitable habitat and the capability of bats to occupy it because of their mobility.

[4] Negative presence/probable absence survey results obtained using the [summer survey guidance](#) are valid for a minimum of two years from the completion of the survey unless new information (e.g., other nearby surveys) suggest otherwise.

Yes

#### **SUBMITTED DOCUMENTS**

- [605296\\_607680\\_Acoustic Report\\_Fitchburg\\_FINAL\\_compiled\\_reduc.pdf https://ipac.ecosphere.fws.gov/project/P67ACLVATNE7NJUSMZB7YQ2PSY/projectDocuments/120535429](https://ipac.ecosphere.fws.gov/project/P67ACLVATNE7NJUSMZB7YQ2PSY/projectDocuments/120535429)

12. Did the presence/probable absence (P/A) summer surveys detect Indiana bats and/or NLEB<sup>[1]</sup>?

[1] P/A summer surveys conducted within the fall swarming/spring emergence home range of a documented Indiana bat hibernaculum (contact local Service Field Office for appropriate home range) that result in a negative finding requires additional consultation with the local Service Field Office to determine if clearing of forested habitat is appropriate and/or if seasonal clearing restrictions are needed to avoid and minimize potential adverse effects on fall swarming and spring emerging Indiana bats.

No

13. Were the P/A summer surveys conducted **within** the fall swarming/spring emergence range of a documented Indiana bat hibernaculum<sup>[1]</sup>?

[1] Contact the local Service Field Office for appropriate distance from hibernacula.

No

14. Does the project include activities **within documented NLEB habitat**<sup>[1][2]</sup>?

[1] Documented roosting or foraging habitat – for the purposes of this consultation, we are considering documented habitat as that where Indiana bats and/or NLEB have actually been captured and tracked using (1) radio telemetry to roosts; (2) radio telemetry biangulation/triangulation to estimate foraging areas; or (3) foraging areas with repeated use documented using acoustics. Documented roosting habitat is also considered as suitable summer habitat within 0.25 miles of documented roosts.)

[2] For the purposes of this key, we are considering documented corridors as that where Indiana bats and/or NLEB have actually been captured and tracked to using (1) radio telemetry; or (2) treed corridors located directly between documented roosting and foraging habitat.

No

15. Will the removal or trimming of habitat or trees occur **within** suitable but **undocumented NLEB** roosting/foraging habitat or travel corridors?

Yes

16. What time of year will the removal or trimming of habitat or trees **within** suitable but **undocumented NLEB** roosting/foraging habitat or travel corridors occur?

*C) During both the active and inactive seasons*

17. Will *any* tree trimming or removal occur **within** 100 feet of existing road/rail surfaces?

Yes

18. Will *any* tree trimming or removal occur **between** 100-300 feet of existing road/rail surfaces?

No

19. Are *all* trees that are being removed clearly demarcated?

Yes

20. Will the removal of habitat or the removal/trimming of trees involve the use of **temporary** lighting?

Yes

21. Will the removal of habitat or the removal/trimming of trees include installing new or replacing existing **permanent** lighting?

*Yes*

22. Does the project include wetland or stream protection activities associated with compensatory wetland mitigation?

*No*

23. Does the project include slash pile burning?

*No*

24. Does the project include *any* bridge removal, replacement, and/or maintenance activities (e.g., any bridge repair, retrofit, maintenance, and/or rehabilitation work)?

*Yes*

25. Is there *any* suitable habitat<sup>[1]</sup> for Indiana bat or NLEB **within** 1,000 feet of the bridge? (includes any trees suitable for maternity, roosting, foraging, or travelling habitat)

[1] See the Service's current [summer survey guidance](#) for our current definitions of suitable habitat.

*Yes*

26. Has a bridge assessment<sup>[1]</sup> been conducted **within** the last 24 months<sup>[2]</sup> to determine if the bridge is being used by bats?

[1] See [User Guide Appendix D](#) for bridge/structure assessment guidance

[2] Assessments must be completed no more than 2 years prior to conducting any work below the deck surface on all bridges that meet the physical characteristics described in the Programmatic Consultation, regardless of whether assessments have been conducted in the past. Due to the transitory nature of bat use, a negative result in one year does not guarantee that bats will not use that bridge/structure in subsequent years.

*No*

27. Is the bridge **within** a known maternity colony's home range<sup>[1]</sup>?

[1] Contact your local FWS office for more information if you are uncertain about where the nearest known maternity colony is located.

*No*

28. Have presence/probable absence (P/A) summer surveys<sup>[1][2]</sup> been conducted for this project with at least one survey point **within** suitable habitat and **within** 0.25 miles of the bridge<sup>[3][4]</sup>?

[1] See the Service's [summer survey guidance](#) for our current definitions of suitable habitat.

[2] Presence/probable absence summer surveys conducted within the fall swarming/spring emergence home range of a documented Indiana bat hibernaculum (contact local Service Field Office for appropriate distance from hibernacula) that result in a negative finding requires additional consultation with the local Service Field Office to determine if clearing of forested habitat is appropriate and/or if seasonal clearing restrictions are needed to avoid and minimize potential adverse effects on fall swarming and spring emerging Indiana bats.

[3] For projects within the range of either the Indiana bat or NLEB in which suitable habitat is present, and no bat surveys have been conducted, the transportation agency will assume presence of the appropriate species. This assumption of presence should be based upon the presence of suitable habitat and the capability of bats to occupy it because of their mobility.

[4] Negative presence/probable absence survey results obtained using the [summer survey guidance](#) are valid for a minimum of two years from the completion of the survey unless new information (e.g., other nearby surveys) suggest otherwise.

*Yes, P/A summer surveys were conducted within 0.25 miles of the bridge*

#### **SUBMITTED DOCUMENTS**

- 605296\_607680\_Acoustic\_Report\_Fitchburg\_FINAL\_compiled\_reduc.pdf <https://ipac.ecosphere.fws.gov/project/P67ACLVATNE7NJUSMZB7YQ2PSY/projectDocuments/120535429>

29. Did the presence/probable absence (P/A) summer surveys detect Indiana bats and/or NLEB<sup>[1]</sup>?

[1] P/A summer surveys conducted within the fall swarming/spring emergence home range of a documented Indiana bat hibernaculum (contact local Service Field Office for appropriate home range) that result in a negative finding requires additional consultation with the local Service Field Office to determine if clearing of forested habitat is appropriate and/or if seasonal clearing restrictions are needed to avoid and minimize potential adverse effects on fall swarming and spring emerging Indiana bats.

*No, Indiana bats and/or NLEBs were not detected during the P/A surveys*

30. Did the local Service Field Office verify<sup>[1]</sup> that this presence/probable absence (P/A) summer survey can be used for determining Indiana bat and/or NLEB absence from the bridge?

[1] Coordination with local US Fish and Wildlife Service Field Office regarding the applicability of P/A surveys for this use is required.

*Yes, the local FWS office confirmed that this P/A survey can be used to assume Indiana bats and/or NLEBs are absent from the bridge*

31. Will the bridge removal, replacement, and/or maintenance activities include installing new or replacing existing **permanent** lighting?

*Yes*

32. Does the project include the removal, replacement, and/or maintenance of *any* structure other than a bridge? (e.g., rest areas, offices, sheds, outbuildings, barns, parking garages, etc.)

No

33. Will the project involve the use of *any* **temporary** lighting in addition to the lighting already indicated for habitat removal (including the removal or trimming of trees), or bridge/structure removal, replacement or maintenance activities?

Yes

34. Is there *any* suitable habitat **within** 1,000 feet of the location(s) where **temporary** lighting (other than the lighting already indicated for habitat removal (including the removal or trimming of trees) or bridge/structure removal, replacement or maintenance activities) will be used?

Yes

35. Will the project install *any* new or replace any existing **permanent** lighting in addition to the lighting already indicated for habitat removal (including the removal or trimming of trees) or bridge/structure removal, replacement or maintenance activities?

Yes

36. Is there *any* suitable habitat **within** 1,000 feet of the location(s) where **permanent** lighting (other than the lighting already indicated for habitat removal (including the removal or trimming of trees) or bridge/structure removal, replacement or maintenance activities) will be installed or replaced?

Yes

37. Does the project include percussives or other activities (**not including tree removal/trimming or bridge/structure work**) that will increase noise levels above existing traffic/background levels?

Yes

38. Will the activities that use percussives (**not including tree removal/trimming or bridge/structure work**) and/or increase noise levels above existing traffic/background levels be conducted *during* the active season<sup>[1]</sup>?

[1] Coordinate with the local Service Field Office for appropriate dates.

Yes

39. Will *any* activities that use percussives (**not including tree removal/trimming or bridge/structure work**) and/or increase noise levels above existing traffic/background levels be conducted *during* the inactive season<sup>[1]</sup>?

[1] Coordinate with the local Service Field Office for appropriate dates.

Yes

40. Are *all* project activities that are **not associated with** habitat removal, tree removal/trimming, bridge and/or structure activities, temporary or permanent lighting, or use of percussives, limited to actions that DO NOT cause any additional stressors to the bat species?

Examples: lining roadways, unlighted signage , rail road crossing signals, signal lighting, and minor road repair such as asphalt fill of potholes, etc.

Yes

41. Will the project raise the road profile **above the tree canopy**?

No

42. Are the project activities that use percussives (not including tree removal/trimming or bridge/structure work) consistent with a Not Likely to Adversely Affect determination in this key?

**Automatically answered**

*Yes, because the activities are within 300 feet of the existing road/rail surface, greater than 0.5 miles from a hibernacula, and conducted during the active season within undocumented habitat.*

43. Are the project activities that use percussives (not including tree removal/trimming or bridge/structure work) and/or increase noise levels above existing traffic/background levels consistent with a No Effect determination in this key?

**Automatically answered**

*Yes, because the activities are within 300 feet of the existing road/rail surface, greater than 0.5 miles from a hibernacula, and conducted during the inactive season*

44. Is the location of this project consistent with a Not Likely to Adversely Affect determination in this key?

**Automatically answered**

*Yes, because no bats were detected during presence/probable absence surveys conducted during the summer survey season and outside of the fall swarming/spring emergence periods. Additionally, all activities were at least 0.5 miles from any hibernaculum.*

45. Is the bridge removal, replacement, or maintenance activities portion of this project consistent with a No Effect determination in this key?

**Automatically answered**

*Yes, because the bridge has been assessed using the criteria documented in the BA and no signs of bats were detected*

46. **General AMM 1**

Will the project ensure *all* operators, employees, and contractors working in areas of known or presumed bat habitat are aware of *all* FHWA/FRA/FTA (Transportation Agencies) environmental commitments, including all applicable Avoidance and Minimization Measures?

Yes

## Project Questionnaire

1. Have you made a No Effect determination for *all* other species indicated on the FWS IPaC generated species list?

*N/A*

2. Have you made a May Affect determination for *any* other species on the FWS IPaC generated species list?

*N/A*

3. How many acres<sup>[1]</sup> of trees are proposed for removal between 0-100 feet of the existing road/rail surface?

[1] If described as number of trees, multiply by 0.09 to convert to acreage and enter that number.

*0.1*

4. Please describe the proposed bridge work:

*The bridge will be replaced generally along the same footprint as the existing bridge with reuse of the center pier substructure and new abutments behind the existing masonry abutments.*

5. Please state the timing of all proposed bridge work:

*Summer 2024 - Fall 2025*

## Avoidance And Minimization Measures (AMMs)

This determination key result includes the commitment to implement the following Avoidance and Minimization Measures (AMMs):

### GENERAL AMM 1

Ensure all operators, employees, and contractors working in areas of known or presumed bat habitat are aware of all FHWA/FRA/FTA (Transportation Agencies) environmental commitments, including all applicable AMMs.

## **Determination Key Description: FHWA, FRA, FTA Programmatic Consultation For Transportation Projects Affecting NLEB Or Indiana Bat**

This key was last updated in IPaC on December 01, 2022. Keys are subject to periodic revision.

This decision key is intended for projects/activities funded or authorized by the Federal Highway Administration (FHWA), Federal Railroad Administration (FRA), and/or Federal Transit Administration (FTA), which may require consultation with the U.S. Fish and Wildlife Service (Service) under Section 7 of the Endangered Species Act (ESA) for the endangered **Indiana bat** (*Myotis sodalis*) and the threatened **Northern long-eared bat** (NLEB) (*Myotis septentrionalis*).

This decision key should only be used to verify project applicability with the Service's [February 5, 2018, FHWA, FRA, FTA Programmatic Biological Opinion for Transportation Projects](#). The programmatic biological opinion covers limited transportation activities that may affect either bat species, and addresses situations that are both likely and not likely to adversely affect either bat species. This decision key will assist in identifying the effect of a specific project/activity and applicability of the programmatic consultation. The programmatic biological opinion is not intended to cover all types of transportation actions. Activities outside the scope of the programmatic biological opinion, or that may affect ESA-listed species other than the Indiana bat or NLEB, or any designated critical habitat, may require additional ESA Section 7 consultation.



## **IPaC User Contact Information**

Agency: Massachusetts Department of Transportation

Name: Hana Isihara

Address: 10 Park Plaza

City: Boston

State: MA

Zip: 02116

Email: hana.l.isihara@dot.state.ma.us

Phone: 6178964454

## **Lead Agency Contact Information**

Lead Agency: Federal Highway Administration



MASSWILDLIFE

## DIVISION OF FISHERIES & WILDLIFE

1 Rabbit Hill Road, Westborough, MA 01581

p: (508) 389-6300 | f: (508) 389-7890

[MASS.GOV/MASSWILDLIFE](http://MASS.GOV/MASSWILDLIFE)

May 22, 2023

Melissa Lenker  
Massachusetts Department of Transportation  
10 Park Plaza, Room 7360  
Boston, Massachusetts 02116

Williamstown Conservation Commission  
Town Office  
31 North Street  
Williamstown, MA 01267

RE:     Applicant:             Melissa Lenker  
       Project Location:        Route 7 and Route 43  
       Project Description:     Intersection Safety Improvements at Route 7 and Route 43  
       DEP Wetlands File No.: -  
       **NHESP File No.:         23-1174**  
       **Heritage Hub Form ID: RC-55159**

Dear Commissioners & Applicant:

The Natural Heritage & Endangered Species Program of the Massachusetts Division of Fisheries & Wildlife (the "Division") received a Notice of Intent with site plans (dated 4/27/23, revised date N/A) in compliance with the rare wildlife species section of the Massachusetts Wetlands Protection Act Regulations (310 CMR 10.58(4)(b)). The Division also received the MESA Review Checklist and supporting documentation for review pursuant to the MA Endangered Species Act Regulations (321 CMR 10.18).

### **WETLANDS PROTECTION ACT (WPA)**

Based on a review of the information that was provided and the information that is currently contained in our database, the Division has determined that this project, as currently proposed, **will not adversely affect** the actual Resource Area Habitat of state-protected rare wildlife species. Therefore, it is our opinion that this project meets the state-listed species performance standard for the issuance of an Order of Conditions.

Please note that this determination addresses only the matter of rare wildlife habitat and does not pertain to other wildlife habitat issues that may be pertinent to the proposed project.

### **MASSACHUSETTS ENDANGERED SPECIES ACT (MESA)**

Based on a review of the information that was provided and the information that is currently contained in our database, the Division has determined that this project, as currently proposed, **will not result in a prohibited Take** of state-listed rare species. This determination is a final decision of the Division of Fisheries and Wildlife

---

MASSWILDLIFE

pursuant to 321 CMR 10.18. Any changes to the proposed project or any additional work beyond that shown on the site plans may require an additional filing with the Division pursuant to the MESA. This project may be subject to further review if no physical work is commenced within five years from the date of issuance of this determination, or if there is a change to the project.

Please note that this determination addresses only the matter of state-listed species and their habitats. If you have any questions regarding this letter please contact Melany Cheeseman, Endangered Species Review Assistant, at [Melany.Cheeseman@mass.gov](mailto:Melany.Cheeseman@mass.gov), (508) 389-6357.

Sincerely,

A handwritten signature in black ink, reading "Everose Schlüter". The signature is written in a cursive, flowing style.

Everose Schlüter, Ph.D.  
Assistant Director

cc:

THIS PAGE INTENTIONALLY LEFT BLANK

DOCUMENT A00831

**ARMY CORPS OF ENGINEERS**

**GENERAL PERMIT**

THIS PAGE INTENTIONALLY LEFT BLANK

General Permit No.: NAE-2022-02649  
 Applicant: General Public, Commonwealth of Massachusetts

Final Effective Date: June 2, 2023  
 Expiration Date: June 1, 2028

**Department of the Army  
 General Permits for the Commonwealth of Massachusetts**

The New England District of the U.S. Army Corps of Engineers (USACE) hereby issues twenty-five (25) regional general permits (GPs) for activities subject to USACE jurisdiction in waters of the U.S., including wetlands, navigable waters within the Commonwealth of Massachusetts and adjacent ocean waters to the seaward limit of the outer continental shelf. The Massachusetts GPs (hereafter referred to as the MA GP or GP) are issued in accordance with USACE regulations at 33 CFR 320 – 332 [see 33 CFR 325.5(c)(1)]. These GPs establish criteria and contain permit conditions to ensure that the authorized activities have no more than minimal individual and cumulative adverse impacts to the environment.

This document contains the following sections:

Pages

|             |   |       |
|-------------|---|-------|
| SECTION I   | Statutory Authorities & Regulated Activities              | 2     |
| SECTION II  | Review Categories & Application Procedures                | 3-7   |
| SECTION III | Massachusetts General Permits                             | 8-34  |
| SECTION IV  | General Conditions  | 35-51 |
| SECTION V   | Mitigation Standards                                      | 52-54 |
| SECTION VI  | Federal & State Agency Contact Information & Websites     | 55-56 |
| SECTION VII | Definitions & Acronyms                                    | 57-66 |
| APPENDIX A  | Guidance for Section 106 NHPA Compliance in Massachusetts | 67-71 |
| APPENDIX B  | Pre-Construction Notification                             | 72-77 |
| APPENDIX C  | Self-Verification Notification                            | 78-81 |
| APPENDIX D  | Pre-Construction Notification Application Checklist       | 82-88 |

In issuing these GPs, the Federal Government does not assume any liability for the following: (a) damages to the permitted project or uses thereof as a result of other permitted or unpermitted activities or from natural causes; (b) damages to the permitted project or uses thereof as a result of current or future activities undertaken by or on behalf of the U.S. in the public interest; (c) damages to persons, property or to other permitted or unpermitted activities or structures caused by the activity authorized by any of the GPs; (d) design or construction deficiencies associated with the permitted work; or (e) damage claims associated with any future modification, suspension or revocation of these permits.

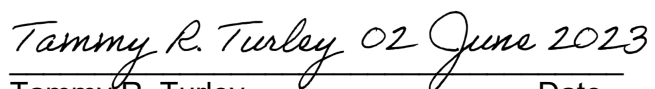
  
 \_\_\_\_\_  
 Tammy R. Turley Date  
 Chief, Regulatory Division

## **SECTION I. STATUTORY AUTHORITIES & REGULATED ACTIVITIES**

### **1. Work Requiring USACE Authorization**

- a. Section 10: Work and structures that are located in, over, under or that affect navigable waters of the United States (U.S.) (see 33 CFR 329). The USACE regulates these activities under section 10 of the Rivers and Harbors Act of 1899 (see 33 CFR 322).
- b. Section 404: The discharge of dredged or fill material into waters of the U.S (see 33 CFR 328). The USACE regulates these activities under Section 404 of the Clean Water Act (CWA). The term “discharge of dredged or fill material” also includes certain discharges resulting from excavation. Applicants should contact USACE to determine if a particular excavation discharge occurring within waters of the U.S., is a regulated activity. See 33 CFR 323.4 of the CWA for exempted activities.

For additional information on the limits of USACE jurisdiction, please see:

[https://www.nae.usace.army.mil/Portals/74/docs/regulatory/JurisdictionalLimits/Jurisdictional\\_Limits\\_Brochure.pdf](https://www.nae.usace.army.mil/Portals/74/docs/regulatory/JurisdictionalLimits/Jurisdictional_Limits_Brochure.pdf)

### **2. Authority to Issue General Permits**

- a. In accordance with 33 CFR 322.2(f), 325.2(e)(2), and 325.5(c), USACE may issue regional general permits authorizing activities under Section 10 of the RHA.
- b. In accordance with Section 404(e) of the CWA, 33 USC 1344(e), and 33 CFR 323.2(h), 325.2(e)(2), and 325.5(c), after notice and opportunity for public hearing, USACE may issue regional general permits for any category of activities involving discharges of dredged or fill material if the activities in such category are similar in nature, will cause only minimal adverse environmental effects when performed separately, and will only have minimal cumulative adverse effect on the environment.

### **3. Related Laws**

33 CFR 320.3 includes a list of related laws including, but not limited to, Section 408 of the Rivers and Harbors Act of 1899, Section 401 of the Clean Water Act, Section 402 of the Clean Water Act, Section 307(c) of the Coastal Zone Management Act of 1972, Section 106 of the National Historic Preservation Act of 1966, Section 7 of the Endangered Species Act, the Fish and Wildlife Coordination Act of 1956, the Magnuson-Stevens Fishery Conservation and Management Act, the Fish and Wildlife Coordination Act, Section 302 of the Marine Protection, Research and Sanctuaries Act of 1972, Section 7(a) of the Wild and Scenic Rivers Act, the Golden Eagle Protection Act, and the Migratory Bird Treaty Act.



## **SECTION II. REVIEW CATEGORIES & APPLICATION PROCEDURES**

To qualify under these GPs, the design, construction, and maintenance associated with each proposed activity must meet the terms and eligibility criteria listed in Section III, all applicable general conditions (GCs) in Section IV, and any specific mitigation requirements in Section V. Applicants should first review the GPs to see if a project is eligible for authorization under one or more of the GPs within this document. Any activity not specifically listed may still be eligible for authorization under these GPs; applicants are advised to contact USACE for specific eligibility determination.

Please note that these GPs allow for Self-Verification (SV) contingent upon meeting all criteria and with full adherence to all GCs. Projects that do not qualify for SV, may meet criteria for Pre-Construction Notification (PCN). Tables are provided under each activity, which outline criteria for SV and PCN. Activities that do not meet criteria for SV or PCN may require review as an Individual Permit (IP). Activities may require a PCN or IP as noted in Sections III and/or IV of this GP. Notwithstanding compliance with the terms of these GPs, USACE retains discretionary authority to require either PCN review or IP review on a case-by-case basis for any project based on concerns for the environment or for any of the other public interest factors found in 33 CFR 320.4(a). These GPs also do not replace or change those activities identified as exempt from USACE regulation (33 CFR 323.4).

### **1. Pre-Application Assistance**

Prospective applicants may request a pre-application meeting to address any questions they may have. USACE may also request a pre-application meeting or additional information to facilitate review of the request. Pre-application meetings and/or site visits help streamline the authorization process by alerting the prospective applicant to potentially time-consuming factors that may arise during the evaluation of their project (e.g., avoidance, minimization and compensatory mitigation requirements, historic properties, endangered species, essential fish habitat, impacts to federal projects, and/or dredging of contaminated sediments).

To schedule a pre-application meeting, present questions, or if you need further assistance, please contact USACE at:

Email: [cenae-r-ma@usace.army.mil](mailto:cenae-r-ma@usace.army.mil) (strongly preferred)

Phone: (978) 318-8338

Mail: U.S. Army Corps of Engineers  
New England District  
Regulatory Division, Massachusetts Section  
696 Virginia Road  
Concord, MA 01742

### **2. Submitting a Request**

Please follow the procedures outlined in Sections II.2-5 when requesting an SV or applying for PCN authorization for activities covered by these GPs. The GPs are provided in Section III below. For SV-eligible projects, the Self-Verification Notification (SVN) must be submitted within 30 days of commencing work. Otherwise, a Pre-Construction Notification (PCN) must be submitted for work that is not SV-eligible. Please include appropriate drawings and attachments and submit your request using the mailbox identified in Section II.4 or II.5 below. USACE will promptly confirm receipt of your request and notify you in the event additional information is required. Guidance on

how to submit electronic correspondence is located on the NAE Regulatory website here:  
<https://www.nae.usace.army.mil/Missions/Regulatory/Submitting-Electronic-Correspondence>.

### 3. Local, State & Federal Approvals

Applicants are responsible for applying for and obtaining any required local, state, and federal permits or approvals. These must be obtained prior to the commencement of work in waters. Such authorizations may include a Water Quality Certification, a Coastal Zone Management Act consistency determination, and other approvals as noted below. Authorization under these GPs does not obviate the need for the permittee to obtain other Federal, State, or local permits, approvals, or authorizations required by law.

#### **I. Water Quality Certification under Section 401 of the Federal Clean Water Act (33 USC 1341).**

Applicants are responsible for determining the appropriate 401 Water quality Certification (WQC) requirements and submitting this information to the USACE at the time of their PCN application or when completing their SVN. Applicants that are unsure of whether their activity has been certified should contact MassDEP, or EPA Region 1 when the activity is located on tribal lands, for a determination. The 401 WQC requirement must be satisfied by acquiring one of the following WQCs from MassDEP (see GC 8):

**General 401 WQC:** The MassDEP issued a WQC on April 21, 2023 conditionally certifies all activities in GPs 1 – 24 eligible for SV and PCN so long as the activity is described in 314 CMR 9.03, and is not an activity described in 314 CMR 9.04, and so long as the activity meets all other requirements, terms and conditions of this WQC. The MassDEP WQC also conditionally certifies activities described in GP 25 so long as the activity meets all other conditions of the WQC. Emergency projects described in GP 25 must obtain an emergency certification or otherwise be authorized pursuant to 310 CMR 10.06, qualify under a Severe Weather Emergency Declaration pursuant to 310 CMR 10.06(8) issued by the MassDEP, or meet the requirements of 9.12(2) or (3) in order to be certified under the WQC

Applicants should refer to the following link to determine if their activity is eligible:

<https://www.nae.usace.army.mil/Missions/Regulatory/State-General-Permits/Massachusetts-General-Permit/>. If eligible, you must comply with all applicable WQC conditions. Activities listed in 314 CMR 9.03 that are not exempt from the Wetland Protection Act must have a valid Final Order of Conditions (OOC) or Final Restoration Order of Conditions pursuant to 310 CMR 10.00 to be eligible under the General 401 WQC.

**Individual 401 WQC:** In the event the proposed activity is not covered by the general WQC, applicants shall contact MassDEP and apply for an individual 401 WQC if their activity does not qualify for a General 401 WQC as outlined above. MassDEP may issue, waive, or deny the individual 401 WQC on a case-by-case basis. All activities listed in 314 CMR 9.04 must obtain an individual 401 WQC from MassDEP to be eligible under these GPs. When an Individual 401 WQC is required for *PCN activities*, the applicant shall submit their Individual 401 WQC application concurrently to MassDEP and the USACE to comply with 40 CFR 121.

**Activities Proposed on Tribal Lands:** When an activity is proposed on Tribal lands, the applicant shall refer to the general 401 WQCs granted by the Environmental Protection Agency (EPA), Region 1 on May 15, 2023. These 401 WQCs are located on the USACE Regulatory website:  
<https://www.nae.usace.army.mil/Missions/Regulatory/State-General-Permits/Massachusetts-General-Permit/>.

**II. Coastal Zone Management Act Federal Consistency Concurrence pursuant to Section 307 of the CZMA of 1972, as amended.**

Federal consistency concurrence is required for all activities located within the coastal zone, unless determined otherwise by the Massachusetts Office of Coastal Zone Management (MA CZM) (see GC 9). As applicable, this requirement must be satisfied by acquiring one of the following from the MA CZM:

**General CZM Federal Consistency Concurrence (General Concurrence):** MA CZM has granted General Concurrence for all SV and PCN activities for GPs 1-25 and this can be found at: <https://www.nae.usace.army.mil/Missions/Regulatory/State-General-Permits/Massachusetts-General-Permit/>. The applicant must obtain all applicable permits and approvals prior to the commencement of work in USACE jurisdiction (i.e., construction begins on site). For SVs, General Concurrence is automatically granted and no further action is required from the applicant. For PCNs, the USACE will coordinate with MA CZM to acquire General Concurrence as part of the PCN application review. During review of the PCN application, USACE may request additional information from the applicant to support CZM's evaluation of the activity.

**Individual CZM Federal Consistency Concurrence (Individual Concurrence):** In certain cases, MA CZM may elevate any GP activity 1-25 to require Individual Concurrence. The applicant must contact MA CZM and follow the procedures to obtain Individual Concurrence as determined appropriate by MA CZM.

The MA CZM program includes five regional offices that serve 78 coastal municipalities. The following map provides more information about these offices: <https://www.mass.gov/service-details/czm-regions-coastal-communities-and-coastal-zone-boundary>

**III. Other Approvals:** Approvals typically required in Massachusetts include, but are not limited to, a Chapter 91 Permit/License, Massachusetts Environmental Protection Act (MEPA) review, Wetlands Protection Act Order of Conditions, and/or Aquaculture Certification. *Applicants should also be aware that USACE may not be able to render a permit decision in the event the proposed activity is denied by another local, state and/or federal agency.*

**4. Procedures for Self-Verification (SV) Eligible Projects**

If the activity is eligible for an SV, the Self-Verification Notification (SVN) must be completed prior to the start of project construction and submitted to USACE within 30 days of commencing work. The purpose of the SVN is to provide applicants with a tool to assist them when determining if the activity as proposed is SV-eligible. The following GPs do not require submission of the SVN: GP 1 (SV #1), GP 3 (SV #2-3), GP 4 (SV #2), GP 11, GP 12 (note #2), GP 14 (see note), GP 15 (see note), and GP 24 (SV #3). **For the activities not listed above, the SVN must be completed prior to the start of work and be kept on site at all times during project construction.** The applicant shall not begin work for SV-eligible activities until they have completely verified the bulleted items below.

Digital submittals by email are **strongly encouraged** to facilitate the most efficient processing of the SVN submittal. Please communicate with USACE staff if you are unable to provide a digital copy. Addresses are [cenae-r-ma-sv@usace.army.mil](mailto:cenae-r-ma-sv@usace.army.mil) (email) or Regulatory Division, U.S. Army Corps of Engineers, New England District, 696 Virginia Road, Concord, MA 01742-2751 (mail).

**Eligible SV Activities:**

- Are subject to USACE jurisdiction (see GC 2); and
- Qualify for one or more of the GPs within this document (Section III); and
- Meet the GCs within this document (Section IV); and

- When required, are supported by a complete SVN (Appendix C); and
- Receive all other required local, State, and/or Federal approvals.

## 5. Procedures for Pre-Construction Notification (PCN) Eligible Projects

For activities that require a PCN, an application to and written authorization from USACE is required. *No work requiring a PCN may proceed until the applicant receives written authorization from USACE verifying that the activity is authorized.* The verification letter may include special conditions that the applicant must comply with. When possible, it is *highly* recommended that PCN application materials are submitted at least 90 days before the target start date to allow for USACE evaluation and any necessary agency consultations. PCN applications shall demonstrate in writing how the proposed activity complies with all GCs, as applicable to their activity.

Digital submittals by email are **strongly encouraged** to facilitate the most efficient processing of the PCN application. Please communicate with USACE staff if you are unable to provide a digital copy. Addresses are [cenae-r-ma@usace.army.mil](mailto:cenae-r-ma@usace.army.mil) or Regulatory Division, U.S. Army Corps of Engineers, New England District, 696 Virginia Road, Concord, MA 01742-2751 (mail).

### Eligible PCN Activities:

- Are subject to USACE jurisdiction (see GC 2); and
- Qualify for one or more of the GPs within this document (Section III); and
- Meet the GCs within this document (Section IV); and
- Comply with the Mitigation Standards within this document (Section V); and
- Are supported by a complete PCN document (Appendix B); and
- When required, are supported by the submittal of project information to the appropriate parties identified in Appendix A; and
- Receive all other required local, State, and/or Federal approvals.

## 6. Interagency Review Procedures

The USACE reserves the opportunity to coordinate PCN activities with Federal and State agencies to ensure that the proposed activity results in no more than a minimal impact to the aquatic environment. In some cases, USACE may require project modifications involving avoidance, minimization, and/or compensatory mitigation for unavoidable impacts to ensure the net effects of a project are minimal. The USACE determines, after review and coordination with the agencies and/or the applicant, if PCN applications:

- a. Meet the terms and conditions of the GP as proposed;
- b. Require additional information;
- c. Require avoidance, minimization, compensatory mitigation, construction sequencing, project modification, or other special conditions to avoid or minimize adverse impacts to the aquatic environment;
- d. Require individual permit review regardless of whether the terms and GCs of these GPs are met, based on concerns for the aquatic environment or any other factor of the public interest (see Section 9 below).

For activities requiring a PCN, the applicant must wait for written authorization from USACE before commencing activities in waters of the U.S. Beginning work for PCN required activities without a USACE written authorization is a violation of these GPs, and the terms and conditions of this document. The applicant may be subjected to an enforcement action by USACE and/or the Environmental Protection Agency (EPA).

## **7. Construction of Solid Fill Structures and Fills Along the Coastline or Baseline from Which the Territorial Sea is Measured.**

Projects involving the construction of solid fill structures or discharge of fill that may extend beyond the coastline or the baseline from which the territorial sea is measured (i.e., mean low water) will require a PCN. The USACE will submit a description of the proposed work and a copy of the plans to the Solicitor, Department of the Interior, Washington, DC 20240, and request comments concerning the effects of the proposed work on the outer continental rights of the United States. These comments will be included in the administrative record of the application. After completion of permit review, the record will be forwarded to the Chief of Engineers. The decision on the application will be made by the Secretary of the Army after coordination with the Attorney General.

## **8. Emergency Activities**

Per 33 CFR 325.2(e)(4), an emergency is limited to a situation that would result in an unacceptable hazard to life, a significant loss of property, or an immediate, unforeseen, and significant economic hardship if corrective action requiring a permit is not undertaken within a time period less than the normal time needed to process an application under standard procedures. Emergency work shall be limited to that which is necessary to stabilize and secure the situation. Additional work needed for final repairs shall not be completed until approval is obtained through the appropriate, non-emergency process. Emergency work is subject to the same terms and conditions of these GPs as non-emergency work, and similarly, must qualify for authorization under these GPs; otherwise, an IP is required. *See GP 25 Emergency Situations for additional information.*

## **9. Individual Permit**

Projects that do not meet the terms and conditions of this GP may require review as an IP (33 CFR 325.5 (b)). Proposed work in this category will require a separate Federal application for an individual permit from USACE (33 CFR 325.1). In addition, USACE retains discretionary authority on a case-by-case basis to elevate GP-eligible activities to an IP based on concerns for the environment or any other factor of the public interest (33 CFR 320.4 (a)). Applicants are required to submit the appropriate application materials directly to USACE as early as possible to expedite the permit review process. General information and application forms can be obtained at our website or by contacting our office at [cenae-r-ma@usace.army.mil](mailto:cenae-r-ma@usace.army.mil) or (978) 318-8338. Individual 401 WQC and/or CZMA Federal consistency concurrence from the appropriate MA agencies are required before USACE can issue an individual permit. Applying for an IP does not relieve the applicant from their obligation to obtain all required Federal, State and/or local approvals.

## **10. Compliance**

Applicants shall ensure compliance with all applicable GPs in Section III, GCs in Section IV, and any special conditions included in USACE verification letters. Noncompliance with these GPs, GCs, and special conditions may subject the applicant to criminal, civil, or administrative penalties, and/or an ordered restoration, and/or the permit may be modified, suspended or revoked by USACE. The USACE will consider any activity requiring USACE authorization to be noncompliant if that activity does not comply with all GP terms and conditions at all times, including while the project is under construction and when work is completed.

### **SECTION III. MASSACHUSETTS GENERAL PERMITS**

Applicants are encouraged to review Sections I & II prior to submitting an application to confirm that the activity as proposed complies with all terms and conditions of the 2023 MA GPs.

Applicants are also encouraged to review the definitions in Section VII, Definitions & Acronyms, of this document. Several terms are frequently used throughout the GPs, and it is important for the reader to understand these terms. If seeking verification for an activity previously verified under the 2018 MA GPs, please contact the USACE to discuss permitting needs in advance of submitting an application.

#### **General Permits**

1. Aids to Navigation and Temporary Recreational Structures
2. Maintenance
3. Moorings
4. Structures in Navigable Waters of the U.S.
5. Boat Ramps and Marine Railways
6. Utility Lines, Oil or Natural Gas Pipelines, Outfall Or Intake Structures, and Appurtenant Features
7. Dredging, Disposal of Dredged Material, Beach Nourishment, Rock Removal and Rock Relocation
8. U.S. Coast Guard Approved Bridges
9. Bank and Shoreline Stabilization
10. Aquatic Habitat Restoration, Enhancement, and Establishment Activities
11. Fish and Wildlife Harvesting and Attraction Devices and Activities
12. Response Operations, Oil and Hazardous Substances
13. Cleanup of Hazardous and Toxic Waste
14. Scientific Measurement Devices
15. Survey Activities
16. Land and Water-Based Renewable Energy Generation Facilities and Hydropower Projects
17. Residential, Commercial and Institutional Developments, and Recreational Facilities
18. Aquaculture
19. Mining Activities
20. Living Shorelines
21. Agricultural Activities
22. Reshaping Existing Drainage Ditches, Construction of New Ditches, and Mosquito Management
23. Linear Transportation Projects and Wetland/Stream Crossings
24. Temporary Construction, Access, and Dewatering
25. Emergency Situations

**GP 1. AIDS TO NAVIGATION AND TEMPORARY RECREATIONAL STRUCTURES (Authority: §10)**

(a) The placement of aids to navigation and regulatory markers that are approved by and installed in accordance with the requirements of the U.S. Coast Guard (USCG). See 33 CFR, Part 66; and (b) Temporary buoys, markers, and similar structures placed for recreational use during specific events such as water skiing competitions and boat races or seasonal use. See GC 16.

**Self-Verification Eligible**

1. Aids to navigation and regulatory markers approved by and installed in accordance with the requirements of the USCG.
2. Temporary buoys, markers and similar structures that are: (a) placed for recreational use during specific events and removed within 30 days after event; or (b) placed during winter events on ice and removed before spring thaw. These structures must be authorized by the local harbormaster, not located within an FNP or its buffer zone, and not located in saltmarsh or tidal vegetated shallows.

**Pre-Construction Notification Required**

1. Impacts in saltmarsh or tidal vegetated shallows.
2. Activities that are not SV eligible.

Note: An SVN submittal to USACE is not required for work authorized under SV #1 above.

**GP 2. MAINTENANCE (Authorities: §10 and §404)**

Repair, rehabilitation, or replacement of any previously authorized<sup>1</sup>, currently serviceable structure, or fill, or of any currently serviceable structure or fill authorized by 33 CFR 330.3 (activities occurring before certain dates), provided that the structure or fill is not to be put to uses differing from those uses specified or contemplated for it in the original permit or the most recently authorized modification. Minor deviations in the structure's configuration or filled area, including those due to changes in materials, construction technique requirements of other regulatory agencies, or current construction codes or safety standards that are necessary to make the repair, rehabilitation, or replacement are authorized. This GP also authorizes temporary structures, fills, and work, including the use of temporary mats, necessary to conduct the activities above. Maintenance dredging and beach nourishment are not eligible under GP 2 (see GP 7). Stream crossing modifications (including sliplining), replacements or extensions are not eligible under GP 2 (see GPs 6, 17, 23). See GP 25 Emergency Situations for expedited review of emergency activities.

**Not authorized under GP 2 (IP required):** (a) Permanent impacts in >1 acre in non-tidal waters and/or wetlands; or (b) Permanent impacts >1/2 acre in tidal waters; >1000 SF in saltmarsh, mud flats, riffle and pool complexes, or non-tidal vegetated shallows; or >100 SF in tidal vegetated shallows; or (c) Temporary impacts >1 acre in tidal waters; >5000 SF in saltmarsh, mud flats, riffle and pool complexes, or non-tidal vegetated shallows; or >1000 SF in vegetated shallows; (d) New stream channelization or stream relocation projects (e.g., those in response to storm or flood events).

**Self-Verification Eligible**

Maintenance activities that meet all of the following terms:

1. In non-tidal waters, the combined permanent and temporary impacts extending beyond the original footprint are ≤5,000 SF<sup>2</sup> and not located in vegetated shallows or riffle and pool complexes.
2. In tidal waters, the combined permanent and temporary impacts extending beyond the original footprint are ≤5,000 SF, ≤1,000 SF in mudflats and/or natural rocky habitat, and not located in saltmarsh and tidal vegetated shallows.
3. Minor deviations in the repair, rehabilitation, or replacement of previously authorized, currently serviceable structures or fills.
4. Bulkhead replacement in tidal and non-tidal waters via installation of new bulkhead within 18 inches of the existing bulkhead and associated backfill.
5. Drawdown of an impoundment for dam/levee repair provided it does not exceed 18 months and one growing season (April through September).

**Pre-Construction Notification Required**

1. Discharges associated with removal of accumulated sediments and debris in the vicinity of existing structures, including intake and outfall structures and associated canals.
2. The removal of sediment outside the immediate vicinity of existing structures (e.g., bridges, culverted road crossings, water intake structures, etc.) that is ≥200 linear feet. This activity is limited to the minimum necessary to restore the waterway in the vicinity of the structure to the approximate dimensions existing when the structure was built.
3. Dam and flood control or levee repair, rehabilitation, or replacement involves:
  - a. A change in the flood elevation or permanent water surface elevation of the impoundment; or
  - b. Drawdown of impoundment for construction exceeding one growing season (see SV eligible #5);
  - c. Any modification that changes the character, scope, or size of the original fill design; or
  - d. Does not meet SV eligible 1-7.
4. Installation of steel piles, including steel sheet piles, that cannot be done in the dry and where NOAA-ESA listed species are mapped as present.

<sup>1</sup> Some maintenance activities may not be subject to regulation under Section 404 of the CWA in accordance with 33 CFR 323.4(a)(2). Per 33 CFR 330.3, Vested dates are: a) Work performed and structures installed before December 18, 1968 (Section 10); and b) Fill placed before July 25, 1975 (Section 404).

<sup>2</sup> This excludes dam projects that may require a temporary drawdown with impacts >5,000 SF in non-tidal waters. Instead, the drawdown shall comply with SV #5 to be eligible under Self-Verification.



6. Any stream channel modification is limited to the minimum necessary for the repair, rehabilitation, or replacement of the structure or fill; such modifications, including the removal of material from the stream channel, must be immediately adjacent to the project or within the boundaries of the structure or fill.

7. Work to previously approved tide gates not affecting upstream tidal resource areas.

5. Activities located in the Connecticut River or Merrimack River, unless they are completed in the dry or when the tide is waterward of the work area.

6. Activities on USACE properties & USACE-controlled easements.

7. Activities that do not require an IP. Activities that do not require a PCN or an IP may be SV eligible.

Notes:

1. This authorizes the repair, rehabilitation, or replacement of any previously authorized structure or fill that does not qualify for the CWA §404(f) exemption for maintenance. See 33 CFR 323.4(a)(2). Prior USACE permits may have included authorization to maintain the activity, in which case authorization under this GP is not necessary.

2. See GC 22 for information on temporary construction mats.

**GP 3. MOORINGS (Authority: §10)**

New moorings and mooring fields; the relocation of previously authorized moorings; expansions, boundary reconfigurations or modifications of previously authorized mooring fields; and maintenance and replacement of moorings.

**Not authorized under GP 3 (IP required):** (a) Moorings or mooring fields converted to or associated with a new boating facility<sup>1</sup>; or (b) Moorings in a USACE Federal Navigation Anchorage or USACE Federal Navigation Channel, except municipal-operated mooring fields.

**Self-Verification Eligible**

1. New or relocated moorings that meet all the following terms:
  - a. Authorized by a local harbormaster/municipality under MGL Chapter 91 §10A; and
  - b. No interference with navigation; and
  - c. Single boat, single-point and non-commercial; and
  - d. Not associated with a boating facility, and
  - e. Neither placed within nor impact tidal vegetated shallows (e.g., eelgrass); and
  - f. Not located within a USACE Federal navigation project (FNP) or the FNP buffer zone.
2. Existing, authorized moorings are converted from traditional moorings to low impact mooring technology (see note below) and/or helical anchors.
3. Maintenance and replacement of moorings authorized by the USACE.

**Pre-Construction Notification Required**

1. New mooring fields; or expansions, boundary reconfigurations or modifications of existing, authorized mooring fields.
2. Moorings located such that they, and/or vessels docked or moored at them, are within the buffer zone of the horizontal limits of a Federal Anchorage. The buffer zone is equal to 3 times the authorized depth of that channel (see GC 15).
3. New individual moorings located in saltmarsh, mudflats, natural rocky habitat, and tidal vegetated shallows. Locating moorings these areas should be avoided to the maximum extent practicable. If these areas cannot be avoided, plans should show conservation mooring or low-impact mooring systems that prevent mooring chains from resting or dragging on the bottom substrate at all tides, where practicable. USACE may require a survey in areas previously mapped as containing eelgrass or within 100 ft. of existing eelgrass beds to document presence or absence of eelgrass and to determine the appropriate type and amount of compensatory mitigation for impacts to eelgrass.
4. Replacement moorings located in tidal vegetated shallows.
5. Moorings that are not SV eligible and do not require an IP.

**Notes:**

1. Low impact mooring systems, including conservation moorings, are encouraged to minimize impacts of chain scouring from conventional moorings during the tidal cycle.
2. An SVN submittal to USACE is not required for work authorized under SV #2-3 above.

<sup>1</sup> Boating facilities are marinas, yacht clubs, boat clubs, boat yards, dockominiums, town facilities, land/homeowner’s associations, etc. that provide for a fee, rent or sell mooring or docking space. Not classified as boating facilities are municipal moorings or municipal mooring fields that charge an equitable user fee based only on the actual costs incurred.

**GP 4. STRUCTURES IN NAVIGABLE WATERS OF THE U.S. (Authority: §10 & §404)**

New, expansions, reconfigurations or modifications of structures for navigational access in waters of the U.S. including but not limited to temporary/seasonal or permanent pile and pole-supported piers, floats, stairs, shore out hauls, and boat and float lifts.

**Not authorized under GP 4 (IP required):** (a) Structures associated with a new boating facility; (b) Structures in a USACE Federal anchorage or channel; or (c) Artificial reefs.

**Self-Verification Eligible**

1. Private, non-commercial piers, floats and lifts that meet all the following terms:
  - a. Piers and floats in: (i) Tidal waters total  $\leq 600$  SF combined; and (ii) Non-tidal navigable waters of the U.S. total  $\leq 600$  SF combined; and
  - b. Piers are  $\leq 4$  feet wide and  $\geq 6$  feet above the marsh substrate (the height is measured from the marsh substrate to the bottom of the lowest longitudinal support); and
  - c. Floats and lifts in tidal waters and non-tidal navigable waters of the U.S. are  $\geq 24$  inches above the substrate during all tidal cycles. Float stops are preferred when site conditions warrant them (i.e., low tide exposes substrate), and skids can only be used in areas where piles are not feasible and on sandy or hard bottom substrates; and
  - d. Piers, floats and lifts: (i) Are  $\geq 25$  feet from previously mapped or existing vegetated shallows, or riparian property line extensions; (ii) Extend  $\leq 25\%$  of the waterway width in non-tidal navigable waters of the U.S. or MHW in tidal navigable waters of the U.S.
  - e. Installation of  $\leq 12$ -inch diameter timber piles. Installation of  $\geq 12$ -inch diameter piles of any material type when installed in the dry.
2. Fenders and similar structures.

**Pre-Construction Notification Required**

1. Shore out hauls.
2. Expansions, modifications, or new reconfiguration zones at any authorized boating facility.
3. New, expansions, reconfigurations, reconfiguration zones, or modifications of structures that provide public, community or government recreational uses such as boating, fishing, swimming, access, etc.
4. Installation of steel piles, including steel sheet piles, that cannot be done in the dry and where NOAA-ESA listed species are mapped as present.
5. Located within the buffer zone of the horizontal limits of an FNP (GC 15).
6. Miscellaneous structures.
7. Impacts in tidal vegetated shallows.
8. Structures that are not SV eligible and do not require an IP.

**Notes:**

1. See GC 19 regarding pile driving and pile removal in navigable waters and
2. See GC 20 regarding time of year restrictions in tidal waters.
3. Boating facilities are facilities that provide for a fee, rent, or sell mooring space, such as marinas, yacht clubs, boat clubs, boat yards, town facilities, dockominiums, etc. Pile supported structures with no discharges of dredged or fill material are not regulated by USACE in non-navigable waters.
4. A SVN submittal to USACE is not required for SV #2 above.

**GP 5. BOAT RAMPS AND MARINE RAILWAYS (Authorities: §10 and §404)**

Activities required for the construction of boat ramps and marine railways, including excavation and fill.

**Not authorized under GP 5 (IP required):** (a) Permanent impacts that are >1 acre in non-tidal waters of the U.S., >½ acre in tidal waters; >1000 SF in saltmarsh, mud flats, riffle and pool complexes, or non-tidal vegetated shallows; or >100 SF in tidal vegetated shallows; (b) Temporary impacts in tidal waters that are >1 acre; >5000 SF in saltmarsh, mud flats, or riffle and pool complexes; or >1000 SF in vegetated shallows<sup>1</sup>; or (c) dredging in navigable waters of the U.S. (see GP 7).

**Self-Verification Eligible**

1. In non-tidal waters, the combined permanent and temporary impacts are (a) ≤5,000 SF, and (b) not located in riffle and pool complexes and non-tidal vegetated shallows.
2. In tidal waters, the combined permanent and temporary impacts are (a) ≤5,000 SF, (b) ≤1,000 SF in mudflats and/or natural rocky habitat, and (c), not located in saltmarsh and tidal vegetated shallows.

**Pre-Construction Notification Required**

1. Boat ramps are located within 25 feet of property line extensions unless the properties are owned by the same owner. The USACE may require a letter of no objection from the abutter(s).
2. Activities that are not eligible for SV and do not require an IP.

**GP 6. UTILITY LINES, OIL OR NATURAL GAS PIPELINES, OUTFALL OR INTAKE STRUCTURES, AND APPURTENANT FEATURES (Authorities: §10 & §404)**

Activities required for: (a) The construction, maintenance, repair or removal of utility lines, oil or natural gas pipelines<sup>1</sup>, outfall or intake structures<sup>2</sup>, and appurtenant features including the associated excavation, backfill, or bedding for these structures. (b) The construction, maintenance, or expansion of substations and other appurtenant facilities associated with a utility line, oil or natural gas pipeline, and outfall or intake structure in non-tidal waters of the U.S.; and (c) The construction and maintenance of foundations for overhead utility line towers, poles, and anchors in tidal and non-tidal waters of the U.S., provided the foundations are the minimum size necessary and separate footings for each tower leg (rather than a larger single pad) are used where feasible. This GP authorizes the construction of access roads to facilitate construction of the above activities provided the activity, in combination with all other activities included in one single and complete project, does not exceed the thresholds identified below (IP required). Access roads used solely for construction of the utility line must be removed upon completion of the work. This GP also authorizes temporary structures, fills, and work, including the use of temporary mats, necessary to conduct the activities above.<sup>3</sup>

**Not authorized under GP 6 (IP required):** (a) Permanent impacts for any single and complete project that are >1 acre in non-tidal waters of the U.S.; >½ acre in tidal waters; >1000 SF in saltmarsh, mud flats, riffle and pool complexes, or non-tidal vegetated shallows; or >100 SF in tidal vegetated shallows; (b) Temporary impacts in tidal waters that are >1 acre; >5000 SF in saltmarsh, mud flats, or riffle and pool complexes; or >1000 SF in vegetated shallows; (c) Stormwater treatment or detention systems, or subsurface sewage disposal systems in waters of the U.S.; or (d) New tide gates that do not meet SV criteria below.

**Self-Verification Eligible**

1. In non-tidal waters, the combined permanent and temporary impacts are (a) ≤5,000 SF, and (b) not located in riffle and pool complexes and non-tidal vegetated shallows.
2. In tidal waters, the combined permanent and temporary impacts are (a) ≤5,000 SF, (b) ≤1,000 SF in mudflats and/or natural rocky habitat, and (c), not located in saltmarsh and tidal vegetated shallows.
3. Intake structures that are dry hydrants used exclusively for firefighting activities with no stream impoundments.
4. New tide gates on outfall structures for pipes conveying stormwater and/or industrial NPDES-permitted discharges from waters that are not waters of the U.S.

**Pre-Construction Notification Required**

1. New outfall and/or intake structures.
2. Unconfined work or silt producing activities in streams with diadromous fish.
3. Submarine cables, conduits, or pipelines that occur in, over or under navigable waters of the U.S.
4. Stream channelization, relocation, impoundment, or loss of streambed occurs.
5. The activity is placed within and runs parallel to or along a streambed within waters of the U.S.
6. There is a permanent change in preconstruction contours in waters of the U.S.
7. Installation of utility lines or gas/oil pipelines using trench excavation where material is temporarily sidecast into waters of the U.S. for >3 months. Applicants must demonstrate how the material would not be dispersed by currents or other forces.
8. Activities that are not SV eligible and do not require an IP.

<sup>1</sup> See the definitions of a “utility line” and “oil or natural gas pipeline” in Section VII.

<sup>2</sup> Outfall structures must be in compliance with regulations issued under the National Pollutant Discharge Elimination System Program (Section 402 of the Clean Water Act).

<sup>3</sup> Temporary impacts shall comply with all GCs, including GC 32 Utility Line Installation and Removal.

**GP 7. DREDGING (Authority: §10), DISPOSAL OF DREDGED MATERIAL (Authorities: §10, §404), BEACH NOURISHMENT (Authorities: §10 & §404), ROCK REMOVAL (Authority: §10) AND ROCK RELOCATION (Authorities: §10 & §404)**

New, improvement and maintenance dredging (see notes below) including: (a) Disposal of dredged material at a confined aquatic disposal cell, beach nourishment location, near shore site, or ocean disposal site selected under Section 404 of the Clean Water Act pursuant to the 404(b)(1) Guidelines, provided the dredged material meets the requirements for such disposal; (b) Beach nourishment not associated with dredging; and (c) Rock removal and relocation for navigation.

**Not authorized under GP 7 (IP required):** (a) Dredging where ocean disposal is required for the disposal of dredged material (Section 103); New dredging >½ acre; ≥10,000 CY; >1000 SF permanent impacts to intertidal areas, saltmarsh, mud flats, riffle and pool complexes, or non-tidal vegetated shallows; or >100 SF permanent impacts to tidal vegetated shallows; (b) Maintenance or improvement dredging and/or disposal with >1 acre of impacts to intertidal areas, saltmarsh, mudflats, riffle and pool complexes, or non-tidal vegetated shallows; (c) New dredging where the primary purpose is sand mining for beach nourishment; (d) Beach scraping; (e) Boulder removal and relocation for navigation >½ acre; or (f) Blasting.

**Self-Verification Eligible**

1. Maintenance dredging of previously dredged areas, with upland disposal, that meet all of the following terms:
  - a. Dredged area ≤1/2 acre; and
  - b. Activities comply with GC 20, TOY Restrictions. The time-of-year restriction(s) stated in Appendix B of the MA Division of Marine Fisheries (DMF) Technical Report TR-47<sup>1</sup> can apply instead if the general TOY restriction if a TOY is provided for a specific waterbody and is less restrictive. This is to protect endangered species, EFH, and other species; and
  - c. The dredge footprint is located >25' from salt marsh or >100' from vegetated shallows; and
  - d. Combined permanent and temporary impacts that are (i) ≤1,000 SF in mudflats or natural rocky habitat, or (ii) ≤5,000 SF within intertidal habitat and areas containing shellfish (an area contains shellfish unless: it is verified that minimal shellfish are present per the local shellfish constable or a shellfish survey; or it is not mapped as a MassGIS shellfish suitability area).
  - e. No return water from upland disposal areas.
2. Boulder relocation with ≤1,000 SF of impacts, relocated to a similar depth and substrate.

**Pre-Construction Notification Required**

1. Maintenance dredging where the primary purpose is sand mining for beach nourishment.
2. New dredging and associated disposal ≤1/2 acre or <10,000 cubic yards.
3. Improvement dredging.
4. Beach nourishment in waters of the U.S. not associated with dredging.
5. Activities that are located in saltmarsh and tidal vegetated shallows.
6. Dredging in a Federal Navigation Project or within the buffer zone (see GC 15).
7. Activities that are not eligible for SV and do not require an IP.

**Notes:**

1. See Section VII for definitions of improvement and maintenance dredging.
2. For PCN activities, the USACE may waive or adjust the time of year requirement on a case-by-case basis after consultation with resource agencies.
3. Disposal site of any dredged material must be identified prior to obtaining USACE authorization.
4. Contact the USACE if a ten-year authorization to maintain an area is desired.

<sup>1</sup> The MA DMF Technical Report TR-47: <https://www.nae.usace.army.mil/Missions/Regulatory/State-General-Permits/Massachusetts-General-Permit/>

**GP 8. U.S. COAST GUARD APPROVED BRIDGES (Authorities: §404)**

Discharges of dredged or fill material incidental to the construction and modification of bridges across navigable waters of the U.S., including cofferdams, abutments, foundation seals, piers, and temporary construction and access fills provided that the USCG authorizes the construction of the bridge structure under Section 9 of the Rivers and Harbors Act of 1899 or other applicable laws. A USCG Authorization Act Exemption or a Surface Transportation and Uniform Relocation Assistance Act (STURRA) (144h) exemption do not constitute USCG authorization.

**Not authorized under GP 8 (IP Required):** Causeways and approach fills (see GP 23).

**Self-Verification Eligible**

1. Discharges of dredged or fill material that are incidental to the construction of bridges across navigable waters and meet all of the following:
  - a. Combined permanent and temporary impacts that are  $\leq 5,000$  SF.
  - b. Combined permanent and temporary impacts that are  $\leq 1,000$  SF in mudflats and natural rocky habitat.
  - c. Not located in saltmarsh and tidal vegetated shallows.

**Pre-Construction Notification Required**

1. Activities on USACE properties & USACE controlled easements.
2. Installation of steel piles, including steel sheet piles, that cannot be done in the dry and where NOAA-ESA listed species are mapped as present.
3. Activities that are not eligible for SV and do not require an IP.

**Notes:**

1. GP 8 is not applicable to bridges over inland waters or wetlands that are not tidally influenced or regulated as navigable under Section 10.
2. See eligibility criteria for GPs 2 & 23 for projects that are not subject to USCG regulations.

**GP 9. BANK AND SHORELINE STABILIZATION (Authorities: §10 & §404)**

Bank stabilization activities necessary for erosion protection along the banks of lakes, ponds, streams, estuarine and ocean waters, and any other open waters. Includes bulkheads, seawalls, riprap, revetments, living seawalls, or slope protection & similar structures, specifically for the purpose of shoreline protection. This GP also authorizes temporary structures, fills, and work, including the use of temporary mats, necessary to conduct the activities above.

Activities must meet the following criteria: (a) No material is placed in excess of the minimum needed for erosion protection; (b) No material is of a type, or is placed in any location, or in any manner, that will impair surface water flow into or out of any waters of the U.S.; (c) No material is placed in a manner that will be eroded by normal or expected high flows (properly anchored native trees and treetops may be used in low energy areas); (d) Native plants appropriate for current site conditions, including salinity, must be used for bioengineering or vegetative bank stabilization; (e) The activity is not a stream channelization activity; and (f) The activity must be properly maintained, which may require repairing it after severe storms or erosion events. This GP authorizes those maintenance and repair activities if they require authorization. This GP also authorizes temporary structures, fills, and work, including the use of temporary mats, necessary to construct the bank stabilization activity. See GP 20 for living shoreline stabilization structures or fills.

**Not authorized under GP 9 (IP required):** (a) New bank stabilization >500 feet in total length (>1,000 linear feet in total length when necessary to protect transportation infrastructure) or permanent loss of saltmarsh >1,000 SF, unless the District Engineer waives this criterion by making a written determination concluding that the discharge of dredged or fill material will result in no more than minimal adverse environmental effects (an exception is for bulkheads – the district engineer cannot issue a waiver for a new bulkhead that is >1,000 feet in length along the bank); (b) Stream channelization or relocation activities; or (c) Breakwaters, groins or jetties.

**Self-Verification Eligible**

1. Activities in tidal and non-tidal waters that are:
  - a. <200 feet in length.
  - b. <400 feet in length when necessary to protect transportation infrastructure.
  - c. ≤1 cubic yard of fill per linear foot average along the bank waterward of the plane of OHW or HTL.
  - d. Not located in non-tidal wetlands, saltmarsh, vegetated shallows.

**Pre-Construction Notification Required**

1. Activities in tidal and non-tidal waters that are:
  - a. ≥200 feet to ≤500 feet in total length. Activities >500 feet in total length must have a written waiver from USACE.
  - b. ≥400 feet to ≤1,000 feet in total length when necessary to protect transportation infrastructure. Activities >1,000 feet in total length must have a written waiver from USACE.
  - c. >1 cubic yard of fill per linear foot average along the bank waterward of the plane of OHW or HTL.
  - d. Located in non-tidal wetlands, saltmarsh, vegetated shallows.
2. Activities with permanent loss of tidal or non-tidal waters that is (a) ≥5,000 SF or (b) ≥1,000 SF in mudflats and natural rocky habitat.
3. Activities that are (a) located in the Connecticut River or Merrimack River and/or (b) require installation of steel piles/steel sheet piles that cannot be done in the dry where NOAA ESA-listed species are mapped as present.
4. Activities on USACE properties & USACE-controlled easements.
5. Activities that require grouted riprap and/or poured/unformed concrete.
6. Activities that are not eligible for SV and do not require an IP.

Note: The applicant shall comply with GC 24. This includes utilization of bioengineering techniques in lieu of hard armoring to the maximum extent practicable as site conditions allow.



**GP 10. AQUATIC HABITAT RESTORATION, ENHANCEMENT, AND ESTABLISHMENT ACTIVITIES**  
**(Authorities: §10 and §404)**

Activities for the restoration, enhancement and establishment of non-tidal and tidal wetlands and riparian areas, including invasive, non-native or nuisance species control; the restoration and enhancement of non-tidal streams and other non-tidal open waters; the relocation of non-tidal waters, including non-tidal streams & associated wetlands for reestablishment of a natural stream morphology and reconnection of the floodplain; the restoration and enhancement of shellfish, finfish and wildlife; and the rehabilitation or enhancement of tidal streams, tidal wetlands and tidal open waters; provided those activities result in net increases in aquatic resource functions and services. See GP 9 for bank and shoreline stabilization. See GP 20 for living shorelines.

**Not authorized under GP 10 (IP required):** Stream channelization activities and artificial reefs.

**Self-Verification Eligible**

1. In tidal and non-tidal waters excluding tidal vegetated shallows, the combined permanent and temporary impacts are ≤5,000 SF.
2. Eelgrass (vegetated shallows) planting and transplanting ≤100 SF in tidal waters.

**Pre-Construction Notification Required**

1. In tidal and non-tidal waters excluding tidal vegetated shallows, the combined permanent and temporary impacts are >5,000 SF.
2. Eelgrass (vegetated shallows) planting and transplanting >100 SF in tidal waters.
3. Permanent water impoundments, dam removal, fish ladders, or tide gates.
4. Stream relocation, impoundment, or loss of streambed occurs.
5. Runneling projects with the purpose of restoring saltmarsh by removing excess water that ponds on the saltmarsh surface.
6. The conversion of: (a) a stream or natural wetlands to another aquatic habitat type (e.g., stream to wetland or vice versa, wetland to pond, etc.) or uplands, (b) one wetland type to another (e.g., forested wetland to an emergent wetland).
7. Activities in the Connecticut River from the Turners Falls Dam to the MA/CT border, or Merrimack River from the Essex Dam to the mouth, involving permanent or temporary impacts unless they are performed <5 feet waterward from OHW or HTL and in the dry. This is to protect endangered species.
8. Activities on USACE properties & USACE-controlled easements.
9. Activities that are not eligible for SV and do not require an IP.

**Notes:**

1. Changes in wetland plant communities that occur when wetland hydrology is more fully restored during wetland rehabilitation activities are not considered a conversion to another aquatic habitat type.
2. See RGL 18-01 for guidance on removal of obsolete dams and other structures from rivers and streams. <https://www.usace.army.mil/missions/civil-works/regulatory-program-and-permits/guidance-letters/>
3. An ecological reference site may be used for a design basis of the restoration activity. The reference site should possess characteristics of an intact aquatic habitat or riparian area that exists in the region. The reference site shall represent the target habitat type of the proposed activity. A reference site may be required at the discretion of USACE.

**GP 11. FISH AND WILDLIFE HARVESTING AND ATTRACTION DEVICES AND ACTIVITIES**  
**(Authorities: §10 and §404)**

Fish and wildlife harvesting and attraction devices and activities in waters of the U.S. such as pound nets, crab traps, crab and shellfish dredging, eel pots, lobster traps, duck blinds, clam and oyster digging, fish aggregating devices, and small fish attraction devices such as open-water fish concentrators (sea kites, etc.).

**Not authorized under GP 11 (IP required):** Artificial reefs; or new, or expansions of, impoundments and semi-impoundments of waters of the U.S. for the culture or holding of motile species such as lobster with an impounded area >1/2 acre.

**Self-Verification Eligible**

1. In non-tidal waters, the combined permanent and temporary impacts are (a) ≤1/2 acre, and (b) not located in riffle and pool complexes and non-tidal vegetated shallows.
2. Fish and wildlife harvesting and attraction devices and activities that do not require a PCN or IP.

**Pre-Construction Notification Required**

1. Pound nets, impoundments or semi-impoundments of waters of the U.S. for the culture or holding of motile species such as lobster with an impounded area ≤1/2 acre, fish aggregating devices, or small fish attraction devices.
2. Devices and activities that are located in tidal vegetated shallows, mud flats, or saltmarsh.
3. Devices and activities that do not require an IP.

Note: An SVN submittal to USACE is not required for work authorized under GP 11.

**GP 12. RESPONSE OPERATIONS, OIL AND HAZARDOUS SUBSTANCES (Authorities: §10 & §404)**

(a) Activities conducted in response to a discharge or release of oil and hazardous substances that are subject to the National Oil and Hazardous Substances Pollution Contingency Plan (40 CFR 300) including containment, cleanup, and mitigation efforts, provided that the activities are done under either: (i) The Spill Prevention, Control and Countermeasure Plan required by 40 CFR 112.3; (ii) The direction or oversight of the Federal on-scene coordinator designated by 40 CFR 300; or (iii) Any approved existing State, regional or local contingency plan provided that the Regional Response Team concurs with the proposed response efforts or does not object to the response effort; (b) Activities required for the cleanup of oil releases in waters of the U.S. from electrical equipment that are governed by EPA's polychlorinated biphenyl (PCB) spill response regulations at 40 CFR 761; (c) Booms placed in navigable waters of the U.S. for oil and hazardous substance containment, absorption and prevention; and (d) The use of structures and fills for spill response training exercises. Wetlands, vegetated shallows, mudflats, and riffle and pool complexes should be restored in place at the same elevation.

**Self-Verification Eligible**

1. Activities are conducted in accordance with (a) or (b) above that are not planned or scheduled, but an emergency response (see Note 1).
2. Booms placed in navigable waters of the U.S. for oil and hazardous substance containment, absorption and prevention.
3. Temporary impacts for spill response training exercises ≤5000 SF in non-tidal waters and ≤1000 SF in tidal waters with no impacts to wetlands, saltmarsh, mudflats, or vegetated shallows.
4. Temporary structures in tidal waters with no impacts to wetlands, saltmarsh, mudflats, vegetated shallows, or riffle and pool complexes and in place ≤30 days.

**Pre-Construction Notification Required**

1. Activities (a) or (b) above are planned or scheduled, not an emergency response; or
2. Activities that are not eligible for SV and do not require an IP.

**Notes:**

1. For emergency response activities in the Connecticut River from the Turners Falls Dam to the MA/CT border, Merrimack River from the Essex Dam to the mouth, and remaining tidal waters that are not rivers, the permittee must contact the USACE at (978) 318-8338 before or as soon as possible after the work authorized under GP 12(a) - (c) commences for the USACE to address effects under the Endangered Species Act.
2. An SVN submittal to USACE is not required for booms used for spill prevention, or properly contained and cleaned de minimus oil or hazardous substance discharges into navigable waters of the U.S.

**GP 13. CLEANUP OF HAZARDOUS AND TOXIC WASTE (Authorities: §10 and §404)**

Specific activities required to affect the containment, stabilization, or removal of hazardous or toxic waste materials, including court ordered remedial action plans or related settlements, which are performed, ordered or sponsored by a government agency with established legal or regulatory authority.

**Not authorized under GP 13:** (a) Establishment of new disposal sites; or (b) Expansion of existing sites used for the disposal of hazardous or toxic waste.

**Self-Verification Eligible**

1. In non-tidal waters, the combined permanent and temporary impacts are (a) ≤5,000 SF, and (b) not located in vegetated shallows and riffle and pool complexes.

**Pre-Construction Notification Required**

1. In non-tidal waters, the combined permanent and temporary impacts are (a) >5,000 SF, and (b) located in vegetated shallows and riffle and pool complexes.  
 2. Permanent and temporary impacts in tidal waters or navigable waters of the U.S.  
 3. Stream channelization, relocation, impoundment, or loss of streambed occurs.  
 4. Activities that are not eligible for SV and do not require an IP.

**Notes:**

1. Wetlands, vegetated shallows, mudflats, and riffle and pool complexes should be restored in place at the same elevation to the maximum extent practicable.  
 2. Activities undertaken entirely on a Comprehensive Environmental Response, Compensation, and Liability Act (CERCLA) site by authority of CERCLA, are not required to obtain permits under Section 404 of the CWA or Section 10 of the Rivers and Harbors Act.

**GP 14. SCIENTIFIC MEASUREMENT DEVICES (Authorities: §10 and §404)**

Scientific measurement devices for measuring and recording scientific data, such as staff gauges, tide and current gauges, meteorological stations, water recording and biological observation devices, water quality testing and improvement devices, and similar structures. Also eligible are small weirs and flumes constructed primarily to record water elevation, flow and/or velocity. Upon completion of the use of the device to measure and record scientific data, the measuring device and any other structures or fills associated with that device (e.g., foundations, anchors, buoys, lines, etc.) must be removed to the maximum extent practicable and the site restored to preconstruction elevations.

**Not authorized under GP 14 (IP required):** (a) Permanent impacts that are >5,000 SF in tidal and non-tidal waters of the U.S.; >1000 SF in tidal saltmarsh, mud flats, riffle and pool complexes; or >100 SF in tidal vegetated shallows; or (b) Temporary impacts in tidal waters that are >1 acre, unless the District Engineer waives this criterion by making a written determination concluding that the discharge of dredged or fill material will result in no more than minimal adverse environmental effects; >5000 SF in saltmarsh, mud flats, or riffle and pool complexes; or >1000 SF in vegetated shallows.

**Self-Verification Eligible**

1. In non-tidal waters, the combined permanent and temporary impacts are (a) ≤5,000 SF, (b) not located in riffle and pool complexes and non-tidal vegetated shallows.
2. In tidal waters, the combined permanent and temporary impacts are (a) ≤5,000 SF, (b) ≤1,000 SF in mudflats and/or natural rocky habitat, (c) not located in saltmarsh and tidal vegetated shallows.
3. Temporary, non-biological sampling devices in waters that do not restrict or concentrate movement of aquatic organisms and will not adversely affect the course, condition, or capacity of a waterway for navigation.
4. Scientific measurement devices, and small weirs and flumes constructed primarily to record water quantity and velocity provided the discharge of fill is limited to 25 cubic yards. These cannot obstruct or restrict the waterway course, condition, capacity, and location.
5. Temporary measuring devices and associated structures (e.g., anchors, buoys, etc.) in tidal and non-tidal waters that do not require a PCN or IP.

**Pre-Construction Notification Required**

1. Biological sampling devices, weirs or flumes, or the activity restricts or concentrates movement of aquatic organisms.
2. Permanent towers located in navigable waters that record and measure scientific data.
3. Devices that are not eligible for SV and do not require an IP.

Note: An SVN submittal to USACE is not required for temporary measuring devices with a footprint of <10 SF, with a profile of <3 feet high measured from the substrate and located in water deeper than -10 feet MLW.

**GP 15. SURVEY ACTIVITIES (Authorities: §10 and §404)**

Survey activities such as soil borings, core sampling, seismic exploratory operations, plugging of seismic shot holes and other exploratory-type bore holes, exploratory trenching, soil surveys, sampling, sample plots or transects for wetland delineations, and historic resources surveys.

**Not authorized under GP 15 (IP required):** (a) Permanent impacts that are >1 acre in tidal and non-tidal waters; >1000 SF in tidal saltmarsh, mud flats, or riffle and pool complexes; or >100 SF in tidal vegetated shallows; or (b) Temporary impacts in tidal waters that are >1 acre, unless the District Engineer waives this criterion by making a written determination concluding that the discharge of dredged or fill material will result in no more than minimal adverse environmental effects; >5000 SF in saltmarsh, mud flats, or riffle and pool complexes; or >1000 SF in vegetated shallows.

**Self-Verification Eligible**

1. In non-tidal waters, the combined permanent and temporary impacts are (a) ≤5,000 SF, (b) not located in riffle and pool complexes and non-tidal vegetated shallows.
2. In tidal waters, the combined permanent and temporary impacts are (a) ≤5,000 SF, (b) ≤1,000 SF in mudflats and/or natural rocky habitat, (c) not located in saltmarsh and tidal vegetated shallows.

**Pre-Construction Notification Required**

1. Exploratory trenching (see Note 2) occurs in waterways (e.g., streams, tidal waters).
2. Activities associated with the recovery of historic resources, and the drilling and discharge of excavated material from test wells for oil and gas exploration.
3. Seismic exploratory operations occur in tidal waters, the Connecticut River from the Turners Falls Dam to the MA/CT border, or the Merrimack River from the Essex Dam to the mouth. This is to protect endangered species.
4. Activities that are not eligible for SV and do not require an IP.

**Notes:**

1. An SVN submittal is not required for wetland delineations, and core sampling conducted for preliminary evaluation of dredge project analysis.
2. For the purposes of GP 15, the term “exploratory trenching” means mechanical land or underwater clearing of the upper soil profile to expose bedrock or substrate for the purpose of mapping or sampling the exposed material.
3. The discharge of drilling mud and cuttings may require a permit under §402 of the CWA.

**GP 16. LAND AND WATER-BASED RENEWABLE ENERGY GENERATION FACILITIES (Authorities: §10 and §404), AND HYDROPOWER PROJECTS (Authority: §10 and §404)**

Structures and work in tidal waters and discharges of dredged or fill material into tidal and non-tidal waters for the construction, expansion, modification or removal of: (a) Land-based renewable energy production facilities (e.g., solar, wind, biomass, geothermal) and their attendant features; (b) Water-based wind or hydrokinetic renewable energy generation projects and their attendant features; and (c) Discharges of dredged or fill material associated with hydropower projects. Attendant features may include, but are not limited to, land-based collection and distribution facilities, control facilities, and parking lots. For each single and complete project in (b) above, no more than 10 generation units (e.g., wind turbines or hydrokinetic devices) are authorized in navigable waters of the U.S. Upon completion of the pilot project (see note 2), the generation units, transmission lines, and other structures or fills associated with the pilot project must be removed to the maximum extent practicable.

**Not authorized under GP 16 (IP required):** (a) Permanent impacts that are >1 acre in non-tidal waters, >½ acre in tidal waters; >1000 SF in saltmarsh, mud flats, riffle and pool complexes, or non-tidal vegetated shallows; or >100 SF in vegetated shallows; or (b) Temporary impacts in tidal waters that are >1 acre; >5000 SF in saltmarsh, mud flats, or riffle and pool complexes; or >1000 SF in vegetated shallows.

**Self-Verification Eligible**

In non-tidal waters, the combined permanent and temporary impacts for land-based activities are (a) ≤5,000 SF, (b) not located in riffle and pool complexes and non-tidal vegetated shallows.

**Pre-Construction Notification Required**

1. In non-tidal waters, the combined permanent and temporary impacts for land-based activities are (a) >5000 SF, or (b) located in vegetated shallows or riffle and pool complexes.
2. Permanent and temporary impacts in tidal waters.
3. Water-based wind or hydrokinetic renewable energy generation projects, and hydropower projects.
4. For all activities eligible for authorization under GP 16:
  - a. The activity occurs in tidal waters or in, over or under navigable waters.
  - b. Stream channelization, relocation, impoundment, or loss of streambed occurs.
5. Activities that are not eligible for SV and do not require an IP.

**Notes:**

1. Utility lines constructed to transfer the energy from the land-based renewable generation or collection facility to a distribution system, regional grid, or other facility may be authorized by GP 6.
2. For the purposes of this GP, the term “pilot project” means an experimental project where the renewable energy generation units will be monitored to collect information on their performance and environmental effects at the project site.

**GP 17. RESIDENTIAL, COMMERCIAL AND INSTITUTIONAL DEVELOPMENTS AND RECREATIONAL FACILITIES (AUTHORITIES: §404)**

Discharges of dredged or fill material into non-tidal waters for the construction or expansion of: (a) Residences and residential subdivisions; (b) Residential, commercial and institutional building foundations and building pads; and (c) Recreational facilities such as playgrounds, playing fields, bikeways, trails, etc. This GP also authorizes attendant features that include, but are not limited to, roads, parking lots, garages, yards, and utility lines, and stormwater management facilities. This GP authorizes attendant features if they are necessary for the use of the project purpose.

**Not authorized under GP 17 (IP required):** (a) Permanent impacts that result in loss of non-tidal waters >1/2 acre; >1000 SF in riffle and pool complexes or vegetated shallows; or (b) Subsurface sewerage disposal systems in non-tidal waters.

**Self-Verification Eligible**

1. In non-tidal waters, the combined permanent and temporary impacts are (a) <5,000 SF, and (b) not located in riffle and pool complexes and non-tidal vegetated shallows.

2. Stream channelization or relocation resulting in loss of streambed that is <200 LF.

**Pre-Construction Notification Required**

1. In non-tidal waters, the combined permanent and temporary impacts are (a) ≥5,000 SF, or (b) located in riffle and pool complexes or non-tidal vegetated shallows.

2. Stream and wetland crossings that require a PCN per GCs 20 TOY Restrictions and GC 31 Stream Work and Crossings & Wetland Crossings.

3. Stream channelization or relocation resulting in loss of streambed that is ≥200 LF. Stream impoundment activities of any kind.

4. Activities on USACE properties & USACE-controlled easements.

5. Activities that are not SV eligible and do not require an IP.

**Notes:**

1. Stream and wetland crossings (permanent and temporary), including those built with construction mats; and modifications (including sliplining), replacements or extensions to existing crossings.

2. See GC 22 for information on temporary construction mats.

3. Subdivisions: For residential subdivisions, the aggregate total loss of waters of United States authorized by this GP cannot exceed 1/2-acre. This includes any loss of waters of the United States associated with development of individual subdivision lots.



**GP 18. AQUACULTURE (Authorities: §10 and §404)**

(a) The installation of buoys, floats, racks, trays, nets, lines, tubes, containers, and other structures into navigable waters of the U.S.; (b) Discharges of dredged or fill material into tidal and non-tidal waters necessary for shellfish seeding, rearing, cultivating, transplanting, and harvesting activities; and (c) Shellfish seeding or brushing the flats projects. Any fill material imported to the project from offsite (this is limited to mineral growth medium used in culture trays) shall be clean and of comparable grain size to the native substrate. Activities authorized under this GP must have (a) their MA DMF Aquaculture Certificate letter for licensed shellfish aquaculture sites, (b) documentation that the applicant has coordinated with the U.S. Coast Guard regarding USCG Private Aids to Navigation standards, (c) their MEPA Certificate (if required), and (d) documentation that the applicant has contacted their local authorities (ex. harbormaster, select board, shellfish constable) for authorization of their facility.

**Not authorized under GP 18 (IP required):** (a) New, or expansions of, impoundments and semi-impoundments of tidal and non-tidal waters for the culture or holding of motile species such as lobster with an impounded area >½ acre; (b) Cultivation of a nonindigenous species (see Note 1) unless that species has been previously cultivated in the waterbody; (c) Cultivation of an aquatic nuisance species (see Note 1); (d) Attendant features such as docks, piers, boat ramps (see GP 4); (e) stockpiles, staging areas, or the deposition of shell material back into tidal and non-tidal waters as waste.

**Self-Verification Eligible**

1. In tidal waters, a new lease site area is (a) ≤2-acre, (b) not located in salt marsh, natural rocky habitat, or tidal vegetated shallows.
2. In tidal waters, expansions of existing lease sites not to exceed 2 acres for the entire site (e.g. 1 acre lease site increasing to a 2 acre lease site may qualify as SV). A PCN is required for expansions in salt marsh, natural rocky habitat, and tidal vegetated shallows.
3. Cages, racks that are elevated ≥2 feet above the ocean floor with legs within a lease site with ≤4 buoys marking the corners.
4. Floating cage strings with a single connecting line, ≤2 anchors and ≤2 end marker buoys per string within a lease site with ≤4 buoys marking the corners.
5. No activities located within 25 feet of tidal vegetated shallows.
6. Culture only indigenous species.
7. Not located in FNP or within a distance of three times the authorized depth of an FNP (see GC 15).
8. Not located in or impinge upon the value of any National Lands or Federal Properties.
9. Floating upweller docks that total ≤600 SF in area.

**Pre-Construction Notification Required**

1. Discharges of fill material associated with aquaculture >5,000 SF.
2. Research, educational, commercial-viability or experimental aquaculture gear activities >1,000 SF.
3. Kelp or finfish aquaculture.
4. Land-based hatchery intakes >3 inches in diameter.
5. Activities in water depths >10 feet mean low lower water (MLLW).
6. Activities with in-water lines, ropes or chains that are not SV eligible (see #3-4).
7. Activities occur in the Connecticut River from the Turners Falls Dam to the MA/CT border or the Merrimack River from the Essex Dam to the mouth. This is to protect endangered species.
8. New, or expansions of, impoundments and semi-impoundments for the culture or holding of motile species such as lobster with an impounded area ≤1/2 acre.
9. Activities that do not require an IP. Activities that do not require a PCN or an IP may be SV eligible.

Note: The Nonindigenous Aquatic Nuisance Prevention and Control Act of 1990 defines: (a) nonindigenous species as “any species or other viable biological material that enters an ecosystem beyond its historic range, including any such organism transferred from one country into another”; and (b) aquatic nuisance species as “a nonindigenous species that threatens the diversity or abundance of native species or the ecological stability of infested waters, or commercial, agricultural, aquacultural, or recreational activities dependent on such waters.”

**GP 19. MINING ACTIVITIES (Authorities: §10 and §404)**

Discharges of dredged or fill material into non-tidal waters for mining activities, except for coal mining and metallic mineral mining activities.

**Not authorized under GP 19 (IP required):** (a) Permanent impacts >1 acre in non-tidal waters; or (b) Activities in tidal waters.

**Self-Verification Eligible**

In non-tidal waters, the combined permanent and temporary impacts are (a) ≤5,000 SF, and (b) not located in riffle and pool complexes, non-tidal vegetated shallows, and streams.

**Pre-Construction Notification Required**

1. In non-tidal waters, the combined permanent and temporary impacts are (a) >5,000 SF, or (b) located in riffle and pool complexes, non-tidal vegetated shallows, and streams.
2. The activity occurs in non-tidal navigable waters of the U.S.
3. Stream channelization, relocation, impoundment, loss of streambed, or discharge of tailings into streams occurs.
4. Work on USACE properties & USACE-controlled easements.
5. Activities that are not eligible for SV and do not require an IP.

**GP 20. LIVING SHORELINES<sup>1</sup> (Authorities: §10 and §404)**

Construction and maintenance of living shorelines to stabilize banks and shores in tidal waters. In non-tidal waters that are not subject to the ebb and flow of the tide, nature-based bank stabilization techniques such as bioengineering and vegetative stabilization may be authorized by GP 9. This GP authorizes those maintenance and repair activities in-kind that are necessary to address changing environmental conditions.

The following terms must be met for both SVs and PCNs as applicable: (a) Coir logs, coir mats, stone, native oyster shell, native wood debris, and other structural materials must be adequately anchored, of sufficient weight, or installed in a manner that prevents relocation in most wave action or water flow conditions, except for extremely severe storms; (b) For living shorelines consisting of tidal fringe wetlands, native plants appropriate for current site conditions, including salinity and elevation, must be used if the site is planted by the permittee; (c) Discharges of dredged or fill material into waters of the U.S., and oyster or mussel reef structures in navigable waters, must be the minimum necessary for the establishment and maintenance of the living shoreline; (d) If sills or other structural materials per PCN #4 must be constructed to protect fringe wetlands for the living shoreline, those structures must be the minimum size necessary to protect those fringe wetlands; (e) The activity must be designed, constructed, and maintained so that it has no more than minimal adverse effects on water and sediment movement between the waterbody and the shore and the movement of aquatic organisms between the waterbody and the shore; and (f) The living shoreline must be properly maintained and monitored, which may require periodic repair of sills, bioengineered components, or replacing sand fills after severe storms or erosion events. Vegetation may be replanted to maintain the living shoreline.

**Not authorized under GP 20 (IP required):** (a) The activity is ≥1000 feet in length along the bank (≥2000 LF both banks) unless waived by the District Engineer; or (b) The activity is >30 feet channel ward of mean low water in tidal waters; or (c) Upland reclamation activities; or (d) Stream channelization or relocation activities; or (e) Breakwaters, groins, jetties, or artificial reefs; or (f) Permanent impacts >1,000 SF in existing saltmarsh; >100 SF in existing tidal vegetated shallows.

**Self-Verification Eligible**

1. Tidal and non-tidal living shorelines ≤100 LF for each bank (≤200 LF for both banks).
2. Combined permanent and temporary impacts ≤5,000 SF in tidal waters, excluding existing salt marsh, tidal vegetated shallows, natural rocky habitat, and mudflats.

**Pre-Construction Notification Required**

1. Tidal and non-tidal living shorelines >100 LF to <1000 LF (>200 LF to <2000 LF for both banks).
2. Permanent and temporary impacts in existing salt marsh, tidal vegetated shallows, or mudflats.
3. Work on USACE properties & USACE-controlled easements.
4. Use of stone sills, native oyster shell, native wood debris, or other structural materials.

**Notes:**

1. PCNs require monitoring for a minimum of 5 years in accordance with an approved restoration plan, unless otherwise determined by the USACE. The first year of monitoring will be the first year that the site has been through a full growing period after completion of construction and planting.
2. Applicants are encouraged to obtain a MEPA certificate prior to submitting a USACE permit application.

<sup>1</sup> A living shoreline has a footprint that is made up mostly of native material. It incorporates vegetation or other living, natural “soft” elements alone or in combination with some type of harder shoreline structure (e.g., oyster or mussel reefs or rock sills) for added protection and stability. Living shorelines should maintain the natural continuity of the land-water interface and retain or enhance shoreline ecological processes. Living shorelines must have a substantial biological component, either tidal or lacustrine fringe wetlands or oyster or mussel reef structures.

**GP 21. AGRICULTURAL ACTIVITIES (Authority: §404)**

Discharges of dredged or fill material in non-tidal waters for agricultural activities, including the construction of building pads for farm buildings. Authorized activities include: (a) installation, placement, or construction of drainage tiles, ditches, or levees; mechanized land clearing; land leveling; the relocation of existing serviceable drainage ditches; and similar activities; (b) construction of farm ponds, excluding perennial streams, provided the farm pond is used solely for agricultural purposes; and (c) discharges of dredged or fill material to relocate existing serviceable drainage ditches constructed in non-tidal streams.

**Not authorized under GP 21 (IP required):** (a) Permanent impacts that are >1 acre in non-tidal waters; or >1000 SF in riffle and pool complexes, or non-tidal vegetated shallows; (b) Work in tidal waters; or (c) Construction of farm ponds in perennial streams.

**Self-Verification Eligible**

In non-tidal waters, the combined permanent and temporary impacts are (a) ≤5,000 SF, and (b) not located in riffle and pool complexes and non-tidal vegetated shallows.

**Pre-Construction Notification Required**

1. In non-tidal waters, the combined permanent and temporary impacts are (a) >5,000 SF, or (b) located in riffle and pool complexes and non-tidal vegetated shallows.
2. Activities occur in non-tidal navigable waters of the U.S.
3. Stream channelization, relocation, impoundment, loss of streambed, or farm ponds in non-perennial streams occurs.
4. Activities that are not eligible for SV and do not require an IP.

Note: Some discharges for agricultural activities may qualify for an exemption under Section 404(f) of the CWA (see 33 CFR 323.4). This GP authorizes the construction of farm ponds that do not qualify for the CWA §404(f)(1)(C) exemption because of the recapture provision at §404(f)(2).

**GP 22. RESHAPING EXISTING DRAINAGE DITCHES, CONSTRUCTION OF NEW DITCHES, AND MOSQUITO MANAGEMENT (Authorities: §10 and §404)**

Discharges to modify the cross-sectional configuration of currently serviceable drainage ditches constructed in tidal and non-tidal waters, for the purpose of improving water quality by regrading the drainage ditch with gentler slopes, which can reduce erosion, increase growth of vegetation, and increase uptake of nutrients and other substances by vegetation. Also authorized are mosquito reduction activities.

**Not authorized under GP 22 (IP required):** Stream channelization, relocation, impoundments, or loss of streambed.

**Self-Verification Eligible**

≤500 linear feet of drainage ditch will be reshaped provided excavated material is deposited in an upland area.

**Pre-Construction Notification Required**

1. >500 linear feet of drainage ditch will be reshaped, excavated material is deposited in a water of the U.S., or the reshaping of the ditch increases the drainage capacity beyond the original as-built capacity or expands the area drained by the ditch as originally constructed (i.e., the capacity of the ditch is not the same as originally constructed or drains additional wetlands or other waters of the U.S.).
2. Permanent and temporary impacts in tidal vegetated shallows.
3. New ditches or relocation of drainage ditches constructed in waters of the U.S. (i.e., the location of the centerline of the reshaped drainage ditch is not approximately the same as the location of the centerline of the original drainage ditch).
4. Activities that are not eligible for SV and do not require an IP.

Note: Some ditch activities are exempt under Section 404(f) of the CWA (see 33 CFR 323.4).

**GP 23. LINEAR TRANSPORTATION PROJECTS AND WETLAND/STREAM CROSSINGS (Authorities: §10 & §404)**

Activities<sup>1</sup> required for the construction, expansion, modification, or improvement of linear transportation projects (e.g., driveways, roads, highways, railways, trails, airport runways, and taxiways) and attendant features. This GP also authorizes temporary structures, fills, and work, including the use of temporary mats (see Note 1), necessary to construct the linear transportation project.

**Not authorized under GP 23 (IP required):** (a) Permanent impacts for any single and complete project that are >1 acre in non-tidal waters; >½ acre in tidal waters; >1000 SF in saltmarsh, mud flats, riffle and pool complexes, or non-tidal vegetated shallows; or >100 SF in tidal vegetated shallows; (b) Temporary impacts in tidal waters that are >1 acre; >5000 SF in saltmarsh, mud flats, or riffle and pool complexes; or >1000 SF in vegetated shallows; (c) Non-linear features commonly associated with transportation projects, such as vehicle maintenance or storage buildings, parking lots, train stations, or aircraft hangars (see GP 17); or (d) New tide gates.

**Self-Verification Eligible**

1. In non-tidal waters, the combined permanent and temporary impacts are a) ≤5,000 SF; b) not located in riffle and pool complexes and non-tidal vegetated shallows; and c) meet the Massachusetts River and Stream Crossing Standards
2. Existing crossings (e.g., culverts, elliptical or arch pipes, etc.) are not modified by (a) decreasing the diameter of the crossing or (b) changing the friction coefficient, such as through slip lining (retrofitting an existing culvert by inserting a smaller diameter pipe), culvert relining or invert lining.
3. Stream channelization or relocation resulting in loss of streambed that is <200 LF.

**Pre-Construction Notification Required**

1. In non-tidal waters, the combined permanent and temporary impacts are a) >5,000 SF; b) located in vegetated shallows or riffle and pool complexes; or c) do not meet the Massachusetts River and Stream Crossing Standards (see note 4).
2. The activity occurs in tidal waters, salt marsh, or in, over or under navigable waters of the U.S.
3. Stream and wetland crossings that require a PCN per GC 20 TOY Restrictions and GC 31 Stream Work and Crossings & Wetland Crossings.
4. Stream channelization or relocation resulting in loss of streambed that is ≥200 LF. Stream impoundment activities of any kind.
5. Work on USACE properties & USACE-controlled easements.
6. Activities that are not eligible for SV and do not require an IP.

**Notes:**

1. See GC 22 for information on temporary construction mats.
2. Discharges of dredged or fill material incidental to the construction of bridges across navigable waters of the U.S. may be authorized under GP 8.
3. Loss of streambed does not require a PCN when bridge piers or similar supports are used.
4. In their PCN application submission to the USACE, applicants must explain why they are unable to meet the Massachusetts River and Stream Crossing Standards.
5. For tidal crossings, modeling is encouraged as a method to verify the proposed crossing would not be undersized and resilient to the effects of sea level rise.

<sup>1</sup> Stream crossings must conform with the MA Stream Crossing Guidelines when practicable and comply with all applicable GCs of this document (Section IV).

**GP 24. TEMPORARY CONSTRUCTION, ACCESS, AND DEWATERING (Authorities: §10 and §404)**

Temporary structures, work, and discharges, including cofferdams, necessary for construction activities or access fills or dewatering of construction sites that are not authorized under another GP activity.

**Not authorized under GP 24 (IP required):** (a) Permanent structures or impacts; (b) Temporary impacts in tidal waters that are >1 acre; >5000 SF in saltmarsh, mud flats, or riffle and pool complexes; or >1000 SF in vegetated shallows; (c) Use of cofferdams to dewater wetlands or other aquatic areas to change their use; (d) Temporary stream crossings (see GPs 6, 17, 23); (e) Structures or fill left in place after construction is completed.

**Self-Verification Eligible**

1. In non-tidal waters, temporary impacts are a) ≤5,000 SF; b) not located in riffle and pool complexes and non-tidal vegetated shallows.
2. In tidal waters, temporary impacts are a) ≤5,000 SF, b) ≤1,000 SF in mudflats and/or natural rocky habitat, and c) not located in saltmarsh and tidal vegetated shallows.
3. Structures in navigable waters of the U.S. provided impacts do not require a PCN and they are left in place ≤30 days.

**Pre-Construction Notification Required**

1. In non-tidal waters, temporary impacts are a) >5,000 SF; b) located in riffle and pool complexes or non-tidal vegetated shallows.
2. In tidal waters, temporary impacts are a) >5,000 SF; b) >1,000 SF in mudflats and/or natural rocky habitat, or (c) located in saltmarsh and tidal vegetated shallows.
3. Activities in the Connecticut River from the Turners Falls Dam to the MA/CT border, or Merrimack River from the Essex Dam to the mouth, involving temporary impacts unless they are performed <5 feet waterward from OHW or HTL and in the dry. This is to protect endangered species; or
4. Activities not eligible for SV and do not require an IP.

**Notes:**

1. Turbidity or sediment resuspension is generally not considered to occur when properly using management techniques to work in dry conditions. See GC 25.
2. Total impact areas under SV Eligible 1-2 exclude use of temporary construction mats. See GC 22 for information on temporary construction mats.
3. An SVN submittal to USACE is not required for SV #3 above.

**GP 25. EMERGENCY SITUATIONS (Authorities: §10 and §404)**

Structures or work in or affecting navigable waters of the U.S. and the discharge of dredged or fill material into waters of the U.S., including wetlands, necessary for repair or protection measures associated with an emergency situation<sup>1</sup>, MassDEP Emergency Declaration/Certification, or FEMA Declared Disaster. The activity shall be the minimum necessary to alleviate the immediate emergency unless that additional work would result in no more than minimal effects to aquatic environment and is necessary to reduce the potential for future failure or loss of the structure or site. Typical activities authorized under this GP include, but are not limited to, restoration of damaged areas; bank stabilization; temporary fills for staging, access, and dewatering; and, repair, replacement, or rehabilitation of existing structures and/or fills (i.e., roads, bridges, utility pipelines and flood control structures, including attendant features, and other existing structures located in waters of the U.S.).

For the restoration of areas damaged by storms floods, or other discrete events: (a) The restored area must not extend waterward of the ordinary high-water mark or high tide line that existed prior to the damage. (b) The slope of the restored area below the ordinary high-water mark or high tide line must not exceed the slope that existed prior to the damage. (c) The bottom elevation of the restored area must not exceed the bottom elevation that existed prior to the damage (i.e., the restored area must not result in a reduction in the depth of the waterbody that existed prior to the damage). (d) Except in cases of FEMA reimbursement, the activity must be initiated, under contract to commence, or funds shall be allocated for the activity within 30 days of authorization under GP 25.

**Not authorized under GP 25 (IP required):** (a) Permanent impacts for a single and complete project >1/2 acre in tidal waters, unless the district engineer waives this criterion by making a written determination concluding that the activity will result in no more than minimal adverse environmental effects; >1,000 SF in saltmarsh, mud flats, riffle and pool complexes, or non-tidal vegetated shallows; or >100 SF in tidal vegetated shallows; (b) Temporary impacts in tidal waters that are >5,000 SF in saltmarsh, mud flats, or riffle and pool complexes; or >1,000 SF in vegetated shallows; (c) New structures or fills that did not previously exist before the storm event or other discrete event (see other GPs).

**Self-Verification Eligible**

1. Activities that qualify under a Severe Weather Emergency Declaration pursuant to 310 CMR 10.06(8) and/or receive an Emergency Certification pursuant to 310 CMR 10.06 and/or meet the requirements of 314 CMR 9.12(2) or (3); and
2. Activities eligible under a FEMA Declared Disaster that also comply with #1 above.

**Pre-Construction Notification Required**

1. Activities that are eligible under a FEMA Declared Disaster and do not qualify under SV #1.
2. Minor deviations in the structure or fill area, including those to existing structures or fills are authorized due to changes in materials, construction techniques, requirements of other regulatory agencies, or current construction codes or safety standards that are necessary to alleviate the emergency.
3. Activities that are not eligible for SV and do not require an IP.

**Notes:**

1. Review the GCs (Section IV) to confirm if a PCN is not required elsewhere in this document.
2. If the activity is not a MassDEP Emergency Declaration/Certification, does not meet the requirements of 314 CMR 9.12(2) or (3), or is not a FEMA Declared Disaster, applicants must explain in writing why their activity qualifies as an emergency (see footnote) to be eligible under GP 25.
3. SV eligible activities qualify under the general 401 WQC MassDEP issued for the 2023 MA GPs (GC 9).

<sup>1</sup> An emergency, as determined by this office and 33 CFR 325.2(e)(4), is one which would result in an unacceptable hazard to life, a significant loss of property, or an immediate, unforeseen, and significant economic hardship if corrective action requiring a Department of the Army permit is not undertaken within a time period less than the normal time to process the request under standard processing procedures.



#### **SECTION IV. GENERAL CONDITIONS:**

To qualify for GP authorization, the applicant must comply with the following general conditions, as applicable, in addition to authorization-specific conditions imposed by the division or district engineer.

1. Other Permits
2. Federal Jurisdictional Boundaries
3. Single and Complete Projects
4. Use of Multiple General Permits
5. Suitable Material
6. Tribal Rights & Burial Sites
7. Avoidance, Minimization, and Compensatory Mitigation
8. Water Quality & Stormwater Management
9. Coastal Zone Management
10. Federal Threatened and Endangered Species
11. Essential Fish Habitat
12. National Lands
13. Wild and Scenic Rivers
14. Historic Properties
15. USACE Property and Federal Projects (§408)
16. Navigation
17. Permit/Authorization Letter On-Site
18. Storage of Seasonal Structures
19. Pile Driving and Pile Removal in Navigable Waters
20. Time of Year Restrictions
21. Heavy Equipment in Wetlands
22. Temporary Fill & Construction Mats
23. Restoration of Wetland Areas
24. Bank Stabilization
25. Soil Erosion and Sediment Controls
26. Aquatic Life Movements and Management of Water Flows
27. Spawning, Breeding, and Migratory Areas
28. Vernal Pools
29. Invasive Species
30. Fills Within 100-Year Floodplains
31. Stream Work and Crossings & Wetland Crossings
32. Utility Line Installation and Removal
33. Water Supply Intakes
34. Coral Reefs
35. Blasting
36. Inspections
37. Maintenance
38. Property Rights
39. Transfer of GP Verifications
40. Modification, Suspension, and Revocation
41. Special Conditions
42. False or Incomplete Information
43. Abandonment
44. Enforcement Cases
45. Previously Authorized Activities
46. Duration of Authorization

**1. Other Permits.** Authorization under these GPs does not obviate the need for the permittee to obtain other Federal, State, or local permits, approvals, or authorizations required by law. Permittees are responsible for obtaining all required permits, approvals, or authorizations. Activities that are not regulated by the State, but subject to USACE jurisdiction, may still be eligible for these GPs.

**2. Federal Jurisdictional Boundaries.**

a. Applicability of these GPs shall be evaluated with reference to Federal jurisdictional boundaries. Activities shall be evaluated with reference to “waters of the U.S.” under the CWA (33 CFR 328) and “navigable waters of the U.S.” under §10 of the Rivers and Harbors Act of 1899 (33 CFR 329).

Permittees are responsible for ensuring that the boundaries used satisfy the Federal criteria defined at 33 CFR 328-329. These sections prescribe the policy, practice, and procedures to be used in determining the extent of the USACE jurisdiction. Note: Waters of the U.S. includes all waters pursuant to 33 CFR 328.3(a), and adjacent wetlands as the term is defined in 33 CFR 328.3(c).

b. Wetlands shall be delineated in accordance with the USACE Wetlands Delineation Manual and the most recent Northcentral/Northeast Regional Supplement. Wetland delineation and jurisdiction information is located at: [www.nae.usace.army.mil/missions/regulatory/jurisdiction-and-wetlands](http://www.nae.usace.army.mil/missions/regulatory/jurisdiction-and-wetlands) and maps are located at [www.nae.usace.army.mil/missions/regulatory/state-general-permits/massachusetts-general-permit](http://www.nae.usace.army.mil/missions/regulatory/state-general-permits/massachusetts-general-permit).

c. Vegetated shallows shall be delineated when present on the project site. Vegetated shallow survey guidance and maps are located at: [www.nae.usace.army.mil/missions/regulatory/state-general-permits/massachusetts-general-permit](http://www.nae.usace.army.mil/missions/regulatory/state-general-permits/massachusetts-general-permit).

d. Natural rocky habitats shall be delineated when present on the project site. The definition of natural rocky habitats is in Section VII of the MA GP. Natural rocky habitat survey guidance and maps are located at: [www.nae.usace.army.mil/missions/regulatory/state-general-permits/massachusetts-general-permit](http://www.nae.usace.army.mil/missions/regulatory/state-general-permits/massachusetts-general-permit).

**3. Single and Complete Projects.** The MA GP shall not be used for piecemeal work and shall be applied to single and complete projects. The term “single and complete project” is defined at 33 CFR 330.2(i) as the total project proposed or accomplished by one owner/developer or partnership or other association of owners/developers.

a. For non-linear projects, a single and complete project must have independent utility. Portions of a multi-phase project that depend upon other phases of the project do not have independent utility. Phases of a project that would be constructed, even if the other phases were not built, can be considered as separate single and complete projects with independent utility.

b. Unless USACE determines the activity has independent utility, all components of a single project and/or all planned phases of a multi-phased project (e.g., subdivisions should include all work such as roads, utilities, and lot development) shall be evaluated as one single and complete project.

c. For linear projects such as power lines or pipelines with multiple crossings, a “single and complete project” is all crossings of a single water of the U.S. (i.e., single waterbody) at a specific location. For linear projects crossing a single waterbody several times at separate and distant locations, each crossing is considered a single and complete project. However, individual channels in a braided stream or river, or individual arms of a large, irregularly shaped wetland or lake, etc., are not separate waterbodies, and crossings of such features cannot be considered separately. If any crossing requires a PCN review or an individual permit review, then the entire linear project shall be reviewed as one project under PCN or the individual permit procedures.

**4. Use of Multiple General Permits.** The use of more than one GP for a single and complete project is prohibited, except when the acreage loss of waters of the U.S. authorized by the GPs does not exceed the acreage limit of the GPs with the highest specified acreage limit. For example, if a road crossing over waters is constructed under GP 23, with an associated utility line

crossing authorized by GP 6, if the maximum acreage loss of waters of the U.S. for the total project is  $\geq 1$  acre it shall be evaluated as an IP.

**5. Suitable Material & Discharge of Pollutants.** No activity may use unsuitable material (e.g., trash, debris, car bodies, asphalt, etc.). All activities involving any discharge into waters of the U.S. authorized under these GPs shall be consistent with applicable water quality standards, effluent limitations, standards of performance, prohibitions, and pretreatment standards and management practices established pursuant to the CWA (33 U.S.C. 1251), and applicable state and local laws. If applicable water quality standards, limitations, etc., are revised or modified during the term of this GP, the authorized work shall be modified to conform with these standards within six months from the effective date of such revision or modification, or within a longer period of time deemed reasonable by the District Engineer in consultation with the Regional Administrator of the EPA. Unless monitoring data indicates otherwise, applicants may presume that their activity complies with state water quality standards provided they are in compliance with the Section 401 WQC (Applicable only to the Section 404 activity).

## **6. Tribal Rights & Burial Sites**

- a. For all SV and PCN applications, prospective permittees shall follow the guidance set forth in Appendix A, Guidance for NHPA Section 106 Compliance in Massachusetts.
- b. No activity or its operation may impair reserved tribal rights, including, but not limited to, reserved water rights and treaty fishing and hunting rights.
- c. Many tribal resources are not listed on the National Register of Historic Places (NRHP) and may require identification and evaluation in collaboration with the identifying tribe and by qualified professionals. The Tribal Historic Preservation Officer (THPO) and State Historic Preservation Officer (SHPO) may be able to assist with locating information on:
  - i. Previously identified tribal resources; and
  - ii. Areas with potential for the presence of tribal resources.
- d. Discovery of Previously Unknown Remains and Artifacts: If any previously unidentified human remains, cultural deposits, or artifacts are discovered while accomplishing the activity authorized by this permit, you must immediately notify the USACE of what you have found, and to the maximum extent practicable, cease work and avoid construction activities that may affect the remains and artifacts until the required coordination has been completed. The USACE will initiate the appropriate the Federal, Tribal, and state coordination required to determine if the items or remains are eligible for listing in the NRHP and warrant a recovery effort or can be avoided.
- e. Burial Sites: Burial sites, marked or unmarked, are subject to state law (Massachusetts Unmarked Burial Law). Native American burial sites on federal or tribal land are subject to the provisions of Native American Graves Protection and Repatriation Act (NAGPRA). Regulated activities may not result in disturbance or removal of human remains until disposition of the remains has been determined by the appropriate authority under these laws, and the work is authorized by the USACE. Regulated activities which result in an inadvertent discovery of human remains must stop immediately, and the USACE, as well as the appropriate state and tribal authority, must be notified. Regulated work at inadvertent discovery sites requires compliance with state law or NAGPRA, as appropriate, prior to re-starting work.

**7. Avoidance, Minimization, and Compensatory Mitigation.** To qualify under the MA GP, activities must comply with Section V Mitigation Standards and the following as applicable:

- a. Avoid and Minimize: Activities must be designed and constructed to avoid and minimize adverse effects, both temporary and permanent, to waters of the U.S. to the maximum extent practicable at the project site. Avoidance and minimization are required to the extent necessary to ensure that the adverse effects to the aquatic environment (both area and function) are no more than minimal.

b. Compensatory mitigation for unavoidable impacts to waters of the U.S., including direct, indirect, secondary, and temporal loss, will generally be required for permanent impacts that exceed the thresholds identified in Section V, and may be required for temporary impacts, to offset unavoidable impacts which remain after all appropriate and practicable avoidance and minimization has been achieved and to ensure that the adverse effects to the aquatic environment are no more than minimal. Proactive restoration projects or temporary impact work with no secondary effects may generally be excluded from this requirement.

c. Mitigation proposals shall follow the guidelines found in the Compensatory Mitigation for Losses of Aquatic Resources; Final Rule April 10, 2008; 33 CFR 332. Prospective permittees may purchase mitigation credits in-lieu of permittee-responsible mitigation as compensation for unavoidable impacts to waters of the U.S. in the Commonwealth of Massachusetts.

**8. Water Quality & Stormwater Management.** The 401 WQC requirement applies to all activities listed under GPs 1-25, unless determined otherwise by MassDEP. Permittees shall also satisfy stormwater management requirements in Massachusetts.

a. General 401 WQC: MassDEP issued a WQC on April 21, 2023 which conditionally certifies all activities in GPs 1 – 24 eligible for SV and PCN so long as the activity is described in 314 CMR 9.03, and is not an activity described in 314 CMR 9.04, and so long as the activity meets all other requirements, terms and conditions of the WQC. The MassDEP WQC also conditionally certifies activities described in GP 25 so long as the activity meets all other conditions of the WQC.

Emergency projects described in GP 25 must obtain an emergency certification or otherwise be authorized pursuant to 310 CMR 10.06, qualify under a Severe Weather Emergency Declaration pursuant to 310 CMR 10.06(8) issued by the MassDEP, or meet the requirements of 9.12(2) or (3) in order to be certified under the WQC. Prospective permittees may refer to the following link to determine if their activity is eligible: <https://www.nae.usace.army.mil/Missions/Regulatory/State-General-Permits/Massachusetts-General-Permit/>. The General 401 WQC is located here, and it provides detailed information regarding what activities are certified and the conditions for certification. Activities listed in 314 CMR 9.03 that are not exempt from the Wetland Protection Act must have a valid Final Order of Conditions (OOC) or Final Restoration Order of Conditions pursuant to 310 CMR 10.00 to be eligible under the General 401 WQC.

b. Individual 401 WQC: Prospective permittees shall contact MassDEP and apply for an individual 401 WQC if their activity does not qualify for a General 401 WQC as outlined above. MassDEP may issue, waive, or deny the individual 401 WQC on a case-by-case basis. All activities listed in 314 CMR 9.04 must obtain an individual 401 WQC from MassDEP to be eligible under these GPs. When an Individual 401 WQC is required for *PCN activities*, the prospective permittee shall submit their Individual 401 WQC application concurrently to MassDEP and USACE to comply with 40 CFR 121.

c. The prospective permittee is responsible for determining the appropriate 401 WQC requirement and submitting this information to the USACE at the time of their PCN application or when completing their SVN. Prospective permittees that are unsure of whether their activity has been certified should contact MassDEP for a determination.

d. As applicable, all activities shall be compliant with the Massachusetts Stormwater Handbook. The Stormwater Handbook can be accessed on the NAE Regulatory website here: <https://www.nae.usace.army.mil/Missions/Regulatory/State-General-Permits/Massachusetts-General-Permit/>.

e. No work requiring authorization under Section 404 of the CWA may be performed unless (1) the prospective permittee qualifies for coverage under the April 21, 2023 General 401 WQC, (2) the prospective permittee receives an individual Section 401 WQC from the MassDEP, or (3) the MassDEP waives individual Section 401 WQC.

**9. Coastal Zone Management.** The permittee must obtain CZM consistency concurrence when an activity is located in the coastal zone in order to be eligible under the MA GP. This requirement

shall be satisfied by acquiring one of the following from the Massachusetts Office of Coastal Zone Management (MA CZM):

- a. General CZM Federal Consistency Concurrence (General Concurrence): MA CZM has granted General Concurrence for all SV and PCN activities for GPs 1-25. The prospective permittee must obtain all applicable permits and approvals before construction of the authorized activity begins (e.g., before work begins on site). For SVs, General Concurrence is automatically granted and no further action is required from the prospective permittee. For PCNs, the USACE will coordinate with MA CZM to acquire General Concurrence as part of the PCN application review.
- b. Individual CZM Federal Consistency Concurrence (Individual Concurrence): In certain cases, MA CZM may elevate any GP activity 1-25 and require Individual Concurrence. The prospective permittee must contact MA CZM and follow the procedures to obtain Individual Concurrence as determined appropriate by MA CZM.
- c. Permittees must obtain CZM consistency concurrence as outlined above before commencing work authorized under these GPs.

## **10. Federal Threatened and Endangered Species**

- a. No activity is authorized under any GP which is likely to directly or indirectly jeopardize the continued existence of a threatened or endangered species or a species proposed for such designation, as identified under the Federal Endangered Species Act (ESA), or which will directly or indirectly destroy or adversely modify designated critical habitat or critical habitat proposed for such designation. No activity is authorized under any GP which “may affect” a listed species or critical habitat, unless ESA section 7 consultation addressing the consequences of the proposed activity on listed species or critical habitat has been completed. See 50 CFR 402.02 for the definition of “effects of the action” for the purposes of ESA section 7 consultation, as well as 50 CFR 402.17, which provides further explanation under ESA section 7 regarding “activities that are reasonably certain to occur” and “consequences caused by the proposed action.”
- b. Other Federal agencies should follow their own procedures for complying with the requirements of the ESA (see 33 CFR 330.4(f)(1)). If a PCN is required for the proposed activity, the Federal permittee must provide USACE with the appropriate documentation to demonstrate compliance with those requirements. The USACE will verify that the appropriate documentation has been submitted. If the appropriate documentation has not been submitted, additional ESA section 7 consultation may be necessary for the activity and the respective federal agency would be responsible for fulfilling its obligation under section 7 of the ESA.
- c. USFWS ESA-Listed Species: Non-federal applicants shall use the USFWS website, Information for Planning and Consultation (IPAC), to determine if their activity is located within the ESA-listed species range. The IPAC website can be accessed on the NAE Regulatory website: <https://www.nae.usace.army.mil/Missions/Regulatory/State-General-Permits/Massachusetts-General-Permit/>. Applicants shall ensure they have an updated, valid species list before construction begins. This may require applicants to update their species list in IPAC before the start of construction. Note: Applicants should refer to the NAE Regulatory Website at the link above to determine if they have been designated as a non-federal representative. Applicants shall complete Section 7 consultation according to the guidance document located on the NAE Regulatory Website. After completing the Rangewide Determination Key and reaching the outcome “may affect, not likely to adversely affect”, you may be required to wait up to 15 days before that outcome is final and compliance under Section 7 of the ESA is fulfilled.
  - i. *Self-Verification Criteria*: The activity is SV-eligible if:
    - 1) The activity is not located within the ESA-listed species range;
    - 2) Another (lead) Federal agency has completed Section 7 consultation; or
    - 3) The activity is located within the ESA-listed species range *and* USACE has designated the applicant as a non-federal representative under 50 CFR 402.08 of the ESA for all

species within the project's action area. As the non-federal representative, the applicant shall complete consultation through IPAC and reach the outcome of "no effect" or "not likely to adversely affect".

ii. *Pre-Construction Notification Criteria*: The activity requires a PCN if:

- 1) The activity is located within the ESA-listed species range and USACE has NOT designated the applicant as a non-federal representative under 50 CFR 402.08 of the ESA for all species within the project's action area;
- 2) The activity is located in designated or proposed critical habitat; or
- 3) The activity is located within the ESA-listed species range and completion of the IPAC determination key has resulted in the outcome of "may affect" or "may affect, likely to adversely affect"; or
- 4) A PCN is required elsewhere in this document.

d. **NOAA-Listed Species**: Non-federal applicants shall refer to the Section 7 Mapper for federally listed species to determine if any species are mapped as present. When NOAA-listed species are present, the applicant shall generate a species report through the mapper and submit this document as part of their PCN or SVN submission. The NOAA Fisheries' Section 7 Mapper can be accessed here on the NAE Regulatory website here: <https://www.nae.usace.army.mil/Missions/Regulatory/State-General-Permits/Massachusetts-General-Permit/>.

e. Authorization of an activity by an GP does not authorize the "take" of a threatened or endangered species as defined under the ESA. In the absence of separate authorization (e.g., an ESA Section 10 Permit, a Biological Opinion with "incidental take" provisions, etc.) from the FWS or the NMFS, the Endangered Species Act prohibits any person subject to the jurisdiction of the United States to take a listed species, where "take" means to harass, harm, pursue, hunt, shoot, wound, kill, trap, capture, or collect, or to attempt to engage in any such conduct. The word "harm" in the definition of "take" means an act which actually kills or injures wildlife. Such an act may include significant habitat modification or degradation where it actually kills or injures wildlife by significantly impairing essential behavioral patterns, including breeding, feeding or sheltering.

## **11. Essential Fish Habitat (EFH).**

a. SV eligible activities have been determined to result in no more than minimal adverse effects, provided the permittee complies with all terms and conditions of the MA GP as applicable to the activity. NMFS has granted General Concurrence [50 CFR 600.920(g)] for all SV eligible activities. These activities do not require project specific EFH consultation.

b. For PCN required activities, the applicant is required to describe and identify potential adverse effects to EFH and should refer to NOAA Fisheries' EFH Mapper (<http://www.fisheries.noaa.gov/resource/map/essential-fish-habitat-mapper>) and Omnibus Essential Fish Habitat Amendment 2 Volume 2: EFH and HAPC Designation Alternatives and Environmental Impacts ([https://www.habitat.noaa.gov/application/efhmapper/oa2\\_efh\\_hapc.pdf](https://www.habitat.noaa.gov/application/efhmapper/oa2_efh_hapc.pdf)). If an activity is located within EFH, the PCN application must contain:

1. A description of the action located in EFH.
2. An analysis of the potential adverse effects of the action on EFH and the managed Species.
3. Conclusions regarding the effects of the action on EFH.
4. Proposed mitigation, if applicable (refer to the mitigation thresholds located in Section V).

c. Federal agencies shall follow their own procedures for complying with the EFH requirements of the Magnuson-Stevens Fishery Conservation and Management Act. For activities requiring a PCN, the applicant is responsible for furnishing documentation that demonstrates consultation for EFH has been completed.

d. For PCN activities, no work may commence until EFH consultation as required by the Magnuson-Stevens Act has been completed.

**12. National Lands.** Activities that impinge upon the value of any National Wildlife Refuge, National Forest, National Marine Sanctuary, National Historic Landmarks or any other area administered by the National Park Service, U. S. Fish and Wildlife Service (USFWS) or U.S. Forest Service (USFS) require a PCN or Individual Permit. Federal land managers seeking authorization for activities located in the above listed National Lands may proceed under SV, unless a PCN is required elsewhere in this document.

**13. Wild and Scenic Rivers.** The following activities in designated river or study river segments in the National Wild and Scenic River (WSR) System require a PCN unless the Federal agency with direct management responsibility for such river, in Massachusetts this is generally the National Park Service, has determined in writing to the proponent that the proposed work will not adversely affect the WSR designation or study status:

- a. Activities that occur in WSR segments, in and 0.25 miles up or downstream of WSR segments, or in tributaries within 0.25 miles of WSR segments;
- b. Activities that occur in wetlands within 0.25 miles of WSR segments;
- c. Activities that have the potential to alter free-flowing characteristics in WSR segments.

No GP activity may occur in a component of the National Wild and Scenic River System, or in a river officially designated by Congress as a “study river” for possible inclusion in the system while the river is in an official study status, unless the appropriate Federal agency with direct management responsibility for such river, has determined in writing that the proposed activity will not adversely affect the Wild and Scenic River designation or study status.

As of May 10, 2023, affected rivers in Massachusetts include: the Taunton River (40 miles), Sudbury River (16.6 miles), Assabet River (4.4 miles), Concord River (8 miles), Nashua River (27 miles), Squannacook River (16.3 miles), Nissitissit River (4.7 miles), and the Westfield River, including West Branch, Middle Branch, Gendale Brook, East Branch, Drowned Land Brook, Center Brook, Windsor Jamb Brook, Shaker Mill Brook, Depot Brook, Savery Brook, Watson Brook, Center Pond Brook (78.1 miles). The most up to date list of designated and study rivers and their descriptions may be obtained from the appropriate Federal land management agency responsible for the designated Wild and Scenic River or study river (e.g., National Park Service, U.S. Forest Service, Bureau of Land Management, U.S. Fish and Wildlife Service). Information on these rivers is also available at: <http://www.rivers.gov/>.

#### **14. Historic Properties**

- a. For all SV and PCN applications, permittees shall follow the guidance set forth in Appendix A, Guidance for NHPA Section 106 Compliance in Massachusetts.
- b. No undertaking authorized by these GPs shall cause effects<sup>1</sup> (defined in 36 CFR Part 800 and 33 CFR Part 325, Appendix C, and its Interim Guidance) on properties listed on, determined to be eligible for listing on, or potentially eligible for listing on the National Register of Historic Places (NRHP)<sup>2</sup>, including previously unknown historic properties within the permit area, unless the USACE or another Federal action agency has satisfied the consultation requirements of Section 106 of the National Historic Preservation Act (Section 106). If another Federal agency is determined the lead federal agency for compliance with Section 106, applicant must obtain the appropriate documentation and provide this information to the USACE to demonstrate compliance with Section 106. The applicant shall not begin the activity until the USACE notifies them in writing that the documentation provided satisfies Section 106 requirements.

<sup>1</sup> Effect means the alteration to the characteristics of a historic property qualifying it for inclusion in or eligibility for the National Register of Historic Properties.

<sup>2</sup> See the NAE Regulatory website, National Register of Historic Places link here: <https://www.nae.usace.army.mil/Missions/Regulatory/State-General-Permits/Massachusetts-General-Permit/>.

- c. Many historic properties are not listed on the NRHP and may require identification and evaluation by qualified historic preservation and/or archaeological consultants. The State Historic Preservation Officer (SHPO), Massachusetts Board of Underwater Archaeological Resources (BUAR), local historical societies, certified local governments, general public, and NRHP may also be able to assist with locating information on:
  - i. Previously identified historic properties; and
  - ii. Areas with potential for the presence of historic properties.
- d. Discovery of Previously Unknown Remains and Artifacts: If any previously unidentified human remains, cultural deposits, or artifacts are discovered while accomplishing the activity authorized by this permit, you must immediately notify the USACE of what you have found, and to the maximum extent practicable, cease work and avoid construction activities that may affect the remains and artifacts until the required coordination has been completed. The USACE will initiate the Federal, State and tribal coordination required to determine if the items or remains warrant a recovery effort and/or if the site is eligible for listing in the National Register of Historic Places.
- e. Section 110k: Prospective permittees should be aware that section 110k of the NHPA (54 U.S.C. § 306113) prevents the USACE from granting a permit or other assistance to an applicant who, with intent to avoid the requirements of Section 106, has intentionally significantly adversely effected a historic property to which the permit would relate, or having legal power to prevent it, allowed such significant adverse effect to occur, unless the USACE, after consultation with the Advisory Council on Historic Preservation (ACHP), determines that circumstances justify granting such assistance despite the adverse effect created or permitted by the applicant. If circumstances justify granting the assistance, the USACE is required to notify the ACHP and provide documentation specifying the circumstances, the degree of damage to the integrity of any historic properties effected, and proposed mitigation. This documentation must include any views obtained from the applicant, SHPO/THPO, appropriate Indian tribes if the undertaking occurs on or effects historic properties on tribal lands or effects properties of interest to those tribes, and other parties known to have a legitimate interest in the impacts to the permitted activity on historic properties.
- f. Underwater Archaeological Resources: Under Massachusetts General Law Ch. 6, s.'s 179-180, and Ch. 91, s. 63, the BUAR has statutory jurisdiction within state waters and is the sole trustee of the Commonwealth's underwater heritage, charged with the responsibility of encouraging the discovery and reporting, as well as the preservation and protection, of underwater archaeological resources. Underwater archaeological resources located within the waters of the Commonwealth of Massachusetts are property of the Commonwealth, which holds title to these resources and retains regulatory authority over their use. Under Massachusetts General Law, no person, organization or corporation may "remove, displace, damage, or destroy" any underwater archaeological resources located within the Commonwealth's submerged lands except through consultation with the BUAR and in conformity with the permits it issues. <https://www.mass.gov/orgs/board-of-underwater-archaeological-resources>.

**15. USACE Property and Federal Projects. (33 USC §408)**

- a. USACE projects and property can be found at: <https://www.nae.usace.army.mil/Missions/Civil-Works/>.
- b. In addition to any authorization under these GPs, prospective permittee shall contact the USACE Real Estate Division (<https://www.nae.usace.army.mil/Missions/Real-Estate-Division/>) at (978) 318-8585 for work occurring on or potentially affecting USACE properties and/or USACE-controlled easements. Work may not commence on USACE properties and/or USACE-controlled easements until they have received any required USACE real estate documents evidencing site-specific permission to work.
- c. Any proposed temporary or permanent occupation or alteration of a Federal project (including, but not limited to, a levee, dike, floodwall, channel, anchorage, breakwater, seawall, bulkhead, jetty, wharf, pier, or other work built or maintained but not necessarily owned by the United States),



is not eligible for SV and requires a PCN. This includes all proposed structures and work in, over, or under a USACE federal navigation project (FNP) or in the FNP's buffer zone. The buffer zone is an area that extends from the horizontal limits of the FNP to a distance of three times the FNP's authorized depth. The activity also requires review and approval by the USACE pursuant to 33 USC 408 (Section 408 Permission). The prospective permittee may reach out to the POCs located here: <https://www.nae.usace.army.mil/Missions/Section-408/>.

d. Any structure or work constructed in a FNP or its buffer zone shall be subject to removal at the owner's expense prior to any future USACE dredging or the performance of periodic hydrographic surveys.

e. Where a Section 408 permission is required, written verification for the PCN will not be issued prior to the decision on the Section 408 permission request.

## 16. Navigation

a. No activity may cause more than a minimal adverse effect on navigation.

b. Any safety lights and signals prescribed by the U.S. Coast Guard, must be installed, and maintained at the permittee's expense on authorized facilities in navigable waters of the U.S.

c. There shall be no unreasonable interference with navigation by the existence or use of the activity authorized herein, and no attempt shall be made by the permittee to prevent the full and free use by the public of all navigable waters at or adjacent to the activity authorized herein.

d. The permittee understands and agrees that if future U.S. operations require the removal, relocation, or other alteration of the structure or work herein authorized, or if, in the opinion of the Secretary of the Army or his authorized representative, said structure or work shall cause unreasonable obstruction to the free navigation of the navigable waters, the permittee will be required, upon due notice from USACE, to remove, relocate, or alter the structural work or obstructions caused thereby, without expense to the U.S. No claim shall be made against the U.S. on account of any such removal or alteration.

**17. Permit/Authorization Letter On-Site.** For PCNs, the permittee shall ensure that a copy of these GPs and the accompanying authorization letter are at the work site (and the project office) whenever work is being performed, and that all personnel with operational control of the site ensure that all appropriate personnel performing work are fully aware of its terms and conditions. The entire permit authorization shall be made a part of any and all contracts and sub-contracts for work that affects areas of USACE jurisdiction at the site of the work authorized by these GPs. This shall be achieved by including the entire permit authorization in the specifications for work. The term "entire permit authorization" means these GPs, including GCs and the authorization letter (including its drawings, plans, appendices, special conditions, and other attachments), and any permit modifications. If the authorization letter is issued after the construction specifications, but before receipt of bids or quotes, the entire permit authorization shall be included as an addendum to the specifications. If the authorization letter is issued after receipt of bids or quotes, the entire permit authorization shall be included in the contract or sub-contract as a change order. Although the permittee may assign various aspects of the work to different contractors or sub-contractors, all contractors and sub-contractors shall be obligated by contract to comply with all environmental protection provisions contained within the entire authorization letter, and no contract or sub-contract shall require or allow unauthorized work in areas of USACE jurisdiction. For SVs, the permittee shall ensure that a complete and signed copy of the SVN is present on site during construction and is made available for review at any time by USACE and other Federal, State, & Local regulatory agencies. A complete and signed copy of the SVN must be submitted to USACE Regulatory within 30 days of initiating construction of the authorized activity, unless stated otherwise in the applicable GP.

**18. Storage of Seasonal Structures.** Coastal structures such as pier sections, floats, etc., that

are removed from the waterway for a portion of the year (often referred to as seasonal structures) shall be stored in an upland location, located above MHW and not in tidal wetlands. These seasonal structures may be stored on the fixed, pile-supported portion of the structure that is seaward of MHW. This is intended to prevent structures from being stored on the marsh substrate and the substrate seaward of MHW.

### **19. Pile Driving and Pile Removal in Navigable Waters.**

- a. Derelict, degraded or abandoned piles and sheet piles in navigable waters of the U.S., except for those inside existing work footprints for piers, must be completely removed, cut and/or driven to 3 feet below the substrate to prevent interference with navigation, and existing creosote piles that are affected by project activities shall be completely removed if practicable. In areas of fine-grained substrates, piles must be removed by the direct, vibratory or clamshell pull method<sup>1</sup> to minimize sedimentation and turbidity impacts and prevent interference with navigation from cut piles. Removed piles shall be disposed of in an upland location landward of MHW or OHW and not in wetlands, tidal wetlands or mudflats.
- b. A PCN is required for the installation or removal of structures with jetting techniques.
- c. A PCN is required for the installation of >12 inch-diameter piles of any material type or steel piles of any size in tidal waters, unless they are installed in the dry. If piles are not installed in the dry:
  - i. Impact pile driving shall commence with an initial set of three strikes by the hammer at 40% energy, followed by a one-minute wait period, then two subsequent 3-strike sets at 40% energy, with one minute waiting periods, before initiating continuous impact driving.
  - ii. Vibratory pile driving shall be initiated for 15 seconds at reduced energy followed by a one-minute waiting period. This sequence of 15 seconds of reduced energy driving, one-minute waiting period shall be repeated two more times, followed immediately by pile-driving at full rate and energy.
  - iii. In addition to using a soft start at the beginning of the workday for pile driving as described in 19c(i-ii), a soft start must also be used at any time following a cessation of pile driving for a period of 30 minutes or longer.
- d. Bubble curtains may be used to reduce sound pressure levels during vibratory or impact hammer pile driving.

**20. Time-of-Year (TOY) Restrictions.** Activities that include in-water work must comply with the TOY Restrictions below to be SV eligible, otherwise a PCN is required. PCN submittals shall contain written justification for deviation from the TOY Restrictions. The term “in-water work” does not include conditions where the work site is “in-the-dry” (e.g., intertidal areas exposed at low tide). The term “in-the-dry” includes work contained within a cofferdam so long as the cofferdam is installed and subsequently removed outside the TOY Restriction. The TOY restrictions stated in Appendix B of the MA DMF Technical Report TR-47<sup>2</sup> can apply instead for activities in tidal waters if (1) TOYs are provided for a specific waterbody where the activity is proposed and (2) the TOYs are less restrictive than below. The activity must also not require a PCN elsewhere in this document to be SV eligible.

<sup>1</sup> Direct Pull: Each piling is wrapped with a choker cable or chain that is attached at the top to a crane. The crane then pulls the piling directly upward, removing the piling from the sediment. Vibratory Pull: The vibratory hammer is a large mechanical device (5-16 tons) that is suspended from a crane by a cable. The vibrating hammer loosens the piling while the crane pulls up. Clamshell Pull: This can remove intact, broken or damaged pilings. The clamshell bucket is a hinged steel apparatus that operates like a set of steel jaws. The bucket is lowered from a crane and the jaws grasp the piling stub as the crane pulls up. The size of the clamshell bucket is minimized to reduce turbidity during piling removal.

<sup>2</sup> The MA DMF Technical Report TR-47: <https://www.nae.usace.army.mil/Missions/Regulatory/State-General-Permits/Massachusetts-General-Permit/>

**TOY Restriction (No work)****Non-tidal Waters**

Defer to TR-47

**Tidal Waters**

January 15 – November 15

Alternate work windows proposed under a PCN will generally be coordinated with the USFWS and NMFS. Resulting written verifications may include species-specific work allowed windows.

**21. Heavy Equipment in Wetlands.** Operating heavy equipment (drill rigs, fixed cranes, etc.) within wetlands shall be minimized, and such equipment shall not be stored, maintained, or repaired in wetlands, to the maximum extent practicable. Where construction requires heavy equipment operation in wetlands, the equipment shall:

- i. Have low ground pressure (typically  $\leq 3$  psi);
- ii. Be placed on swamp/construction/timber mats (herein referred to as “construction mats” or “mats”) that are adequate to support the equipment in such a way as to minimize disturbance of wetland soil and vegetation. See GC 22 for information on the placement of construction mats; or
- iii. Be operated on adequately dry or frozen wetlands such that shear pressure does not cause subsidence of the wetlands immediately beneath the equipment and upheaval of adjacent wetlands. Construction mats are to be placed in the wetland from the upland or from equipment positioned on mats if working within a wetland. Dragging construction mats into position is prohibited. Other support structures that are capable of safely supporting equipment may be used with written USACE authorization.

**22. Temporary Fill, Work & Construction Mats.**

a. Construction mats in non-tidal waters: Temporary construction mats shall be in place  $\leq 1$  year and for one growing season or less to be SV eligible. A PCN is required if construction mats are in place  $> 1$  year or for more than one growing season. Construction mats can be placed in an area of any size in non-tidal waters. The activity may occur in segments to ensure the requirements for SV above are met, otherwise a PCN is required.

b. Construction mats in tidal waters: Temporary construction mats placed in an area  $< 5,000$  SF in tidal waters are SV eligible, provided those mats are in place  $\leq 6$  months. Temporary construction mats placed in an area  $\geq 5,000$  SF or in place  $> 6$  months in tidal waters require a PCN.

c. Management of construction mats: At a minimum, construction mats shall be managed in accordance with the following construction mat best management practices (BMPs):

1. Mats shall be in good condition to ensure proper installation, use, and removal.
2. As feasible, mats shall be placed in a location that will minimize the amount of mats needed for the wetland crossing(s).
3. Inspect mats prior to their re-use and remove any plant debris. Mats are to be thoroughly cleaned before re-use to prevent the spread of invasive plant species.
4. Impacts to wetland areas shall be minimized during installation, use, and removal of the mats.
5. Adequate erosion & sediment controls shall be installed at approaches to mats to promote a smooth transition to, and minimize sediment tracking onto, the mats.
6. In most cases, mats should be placed along the travel area so that the individual boards are resting perpendicular to the direction of traffic. No gaps should exist between mats. Place mats far enough on either side of the resource area to rest on firm ground.

d. A PCN is required for temporary fills in place  $> 2$  years. All temporary fills and disturbed soils shall be stabilized to prevent the material from eroding into waters of the U.S. where it is not authorized. Work shall include phased or staged development to ensure only areas under active development are exposed and to allow for stabilization practices as soon as practicable. Temporary fill must be placed in a manner that will prevent it from being eroded by expected high flows.

- e. Activities that require unconfined temporary fill and are authorized for discharge into waters of the U.S. shall consist of material that minimizes effects to water quality.
- f. Appropriate measures must be taken to maintain normal downstream flows and minimize flooding to the maximum extent practicable when temporary structures, work, and discharges of dredged or fill material, including cofferdams, are necessary for construction activities, access fills, or dewatering of construction sites. Materials shall be placed in a location and manner that does not adversely impact surface or subsurface water flow into or out of the wetland. Temporary fill authorized for discharge into wetlands shall be placed on geotextile fabric or other appropriate material laid on the pre-construction wetland grade where practicable to minimize impacts and to facilitate restoration to the original grade. Construction mats are excluded from this requirement.
- g. Construction debris and deteriorated materials shall not be located in waters of the U.S.
- h. Temporary fills, construction mats, and corduroy roads shall be entirely removed as soon as they are no longer needed to construct the authorized activity and the disturbed areas be restored to pre-construction contours and conditions.
- i. Construction equipment, such as temporary barges in tidal waters, shall provide clearance above the substrate to avoid grounding onto the substrate during all tides.

### **23. Restoration of Wetland Areas.**

- a. Upon completion of construction, all disturbed wetland areas shall be stabilized with a wetland seed mix or plant plugs containing only plant species native to New England, and be appropriate for site conditions, including salinity and frequency of inundation, and shall not contain any species listed in the "Invasive and Other Unacceptable Plant Species" Appendix K of the New England District "Compensatory Mitigation Standard Operating Procedures" found at <https://www.nae.usace.army.mil/Missions/Regulatory/Mitigation.aspx>.
- b. The introduction or spread of invasive plant species in disturbed areas shall be prevented and controlled. Equipment shall be thoroughly cleaned before and after project construction to prevent the spread of invasive species. This includes, but is not limited to, tire treads and construction mats.
- c. In areas of authorized temporary disturbance, if trees are cut in USACE jurisdiction, they shall be cut at or above ground level and not uprooted in order to prevent disruption of any kind to the wetland soil structure and to allow stump sprouts to revegetate the work area, unless otherwise authorized.
- d. Wetland areas where permanent disturbance is not authorized shall be restored to their original condition and elevation, which under no circumstances shall be higher than the pre-construction elevation. Original condition means careful protection and/or removal of existing soil and vegetation, and replacement back to the original location such that the original soil layering and vegetation schemes are approximately the same, unless otherwise authorized.

### **24. Bank Stabilization.**

- a. Projects involving construction or reconstruction/maintenance of bank stabilization within USACE jurisdiction shall be designed to minimize environmental effects, effects to neighboring properties, scour, conversion of natural shoreline to hard armoring, etc. to the maximum extent practicable.
- b. Projects involving the construction of new bank stabilization within USACE jurisdiction shall use bioengineering techniques and natural materials in the project design to the maximum extent practicable. Use of hard structures shall be eliminated or minimized unless the prospective permittee can demonstrate that use of bioengineering techniques is not practicable due to site conditions.
- c. Where possible, bank stabilization projects shall optimize the natural function of the shoreline, including self-sustaining stability to attenuate flood flows, fishery, wildlife habitat and water quality protection, while protecting upland infrastructure from storm events that can cause erosion as well as impacts to public and private property.
- d. No material shall be placed in excess of the minimum needed for erosion protection.
- e. No material shall be placed in a manner that will be eroded by normal or expected high flows (properly anchored native trees and treetops may be used in low energy areas).

- f. Native plants appropriate for current site conditions, including salinity, must be used for bioengineering or vegetative bank stabilization.
- g. The activity must be properly maintained, which may require repairing it after severe storms or erosion events.

## **25. Soil Erosion and Sediment Controls.**

- a. Appropriate soil erosion and sediment controls<sup>1</sup> (hereinafter referred to as “controls”) must be installed prior to earth disturbance and maintained in effective operating condition during construction. Biodegradable wildlife friendly erosion controls should be used whenever practicable to minimize effects to water quality.
- b. Activities in streams (rivers, streams, brooks, etc.) and tidal waters that are capable of producing sedimentation or turbidity should be done during periods of low-flow or no-flow, when the stream or tide is waterward of the work area. Controls may also be used to obtain dry work conditions (e.g., coffer dam, turbidity curtain). The prospective permittee must demonstrate in the project plans where the controls are proposed and how these controls would avoid and/or minimize turbidity or sedimentation.
- c. A PCN is required for controls that encroach: i) >25% of the stream width measured from OHW in non-tidal diadromous streams from March 15 to June 30; or ii) >25% of the waterway width measured from MHW in tidal waters from Feb. 1 to June 30, or >50% of the waterway width measured from MHW in tidal waters from July 1 to Jan. 14. This is to protect upstream fish passage. Proponents must also maintain downstream fish passage throughout the project.
- d. No dewatering shall occur with direct discharge to waters or wetlands. Excess water in isolated work areas shall be pumped or directed to a sedimentation basin, tank or other dewatering structures in an upland area adequately separated from waters or wetlands. Suspended solids shall be removed prior to discharge back into waters or wetlands from these dewatering structures. All discharge points back into waters and wetlands shall use appropriate energy dissipaters and erosion and sedimentation control BMPs.
- e. Temporary controls shall be removed upon completion of work, but not until all exposed soil and other fills, as well as any work waterward of OHW or the HTL, are permanently stabilized at the earliest practicable date. Sediment and debris collected by these devices shall be removed and placed at an upland location in a manner that will prevent its later erosion into a waterway or wetland. Controls may be left in place if they are biodegradable and flows and aquatic life movements are not disrupted.

## **26. Aquatic Life Movements and Management of Water Flows.**

- a. No activity may substantially disrupt the necessary life cycle movements of those species of aquatic life indigenous to the waterbody, including those species that normally migrate through the area, unless the activity’s primary purpose is to impound water. All permanent and temporary crossings of waterbodies and wetlands shall be:
  - i. Suitably spanned, bridged, culverted, or otherwise designed and constructed to maintain low flows to sustain the movement of those aquatic species; and
  - ii. Properly aligned and constructed to prevent bank erosion or streambed scour both adjacent to and inside the crossing.

<sup>1</sup> Appropriate soil erosion, sediment and turbidity controls include cofferdams, bypass pumping around barriers immediately up and downstream of the work footprint (i.e., dam and pump), installation of sediment control barriers (i.e., silt fence, vegetated filter strips, geotextile silt fences, filter tubes, erosion control mixes, hay bales or other devices) downhill of all exposed areas, stream fords, retention of existing vegetated buffers, application of temporary mulching during construction, phased construction, and permanent seeding and stabilization, etc.

- b. To avoid adverse impacts on aquatic organisms, the low flow channel/thalweg shall remain unobstructed during periods of low flow, except when necessary to perform the authorized work.
- c. For work in tidal waters, in-stream controls (e.g., cofferdams) should be installed in such a way as to not obstruct fish passage.
- d. Riprap and other stream bed materials shall be installed in a manner that avoids organism entrapment in rock voids or water displaced to subterranean flow with crushed stone and riprap.
- e. To the maximum extent practicable, the preconstruction course, condition, capacity, and location of open waters must be maintained for each activity, including stream channelization, storm water management activities, and temporary and permanent road crossings, except as provided below. The activity must be constructed to withstand expected high flows. The activity shall not restrict or impede the passage of normal or high flows unless the primary purpose of the activity is to impound water or manage high flows. The activity may alter the pre-construction course, condition, capacity, and location of open waters if it benefits the aquatic environment (e.g., stream restoration or relocation activities).

### **27. Spawning, Breeding, and Migratory Areas.**

- a. Activities in spawning areas during spawning seasons must be avoided to the maximum extent practicable. Activities that result in the physical destruction (e.g., through excavation, fill, or downstream smothering by substantial turbidity) of an important spawning area are not authorized under these GPs.
- b. Activities in waters of the U.S. that serve as breeding areas for migratory birds must be avoided to the maximum extent practicable.
- c. The applicant is responsible for obtaining any “take” permits required under the USFWS’s regulations governing compliance with the Migratory Bird Treaty Act or the Bald and Golden Eagle Protection Act. The applicant should contact the appropriate local office of the USFWS to determine if such “take” permits are required for a particular activity.
- d. Information on spawning habitat for species managed under the Magnuson-Stevens Fishery Conservation and Management Act (i.e., EFH for spawning adults) can be obtained from NAE Regulatory website, Essential Fish Habitat section, at: <https://www.nae.usace.army.mil/Missions/Regulatory/State-General-Permits/Massachusetts-General-Permit/>.
- e. Information regarding diadromous fish habitat can be obtained from the following DMF website at: <https://www.mass.gov/info-details/massgis-data-diadromous-fish>.

### **28. Vernal Pools.**

- a. A PCN is required if a discharge of dredged or fill material is proposed within a vernal pool depression that is also a water of the U.S.
- b. Vernal pools must be identified on the plans that show aquatic resource delineations.
- c. Adverse impacts to vernal pools shall be avoided & minimized to the maximum extent practicable.

### **29. Invasive Species.**

- a. The introduction, spread or the increased risk of invasion of invasive plant or animal species on the project site, into new or disturbed areas, or areas adjacent to the project site caused by the site work shall be avoided. Construction mats shall be thoroughly cleaned before reuse to avoid spread of invasive species.
- b. Unless otherwise directed by USACE, all applications for PCN non-tidal projects proposing fill in USACE jurisdiction shall include an Invasive Species Control Plan. Additional information can be found at: <https://www.nae.usace.army.mil/Missions/Regulatory/Invasive-Species/>, <https://www.nae.usace.army.mil/Missions/Regulatory/Mitigation/>.

**30. Fills Within 100-Year Floodplains.** The activity shall comply with applicable Federal Emergency Management Agency (FEMA) approved, Massachusetts Emergency Management

Agency (MEMA) approved and/or local floodplain management requirements. Applicants should contact FEMA and/or MEMA regarding floodplain management requirements.

### **31. Stream Work and Crossings & Wetland Crossings.**

- a. When feasible, all temporary and permanent crossings of waterbodies and wetlands (hereinafter referred to as “crossings”) shall conform to the “Massachusetts River and Stream Crossing Standards” located at: <https://www.mass.gov/doc/massachusetts-river-and-stream-crossing-standards/download> or <https://www.nae.usace.army.mil/Missions/Regulatory/State-General-Permits/Massachusetts-General-Permit/>. Projects that do not conform to these guidelines shall be reviewed under PCN or IP procedures.
- b. Crossings shall be suitably culverted, bridged, or otherwise designed to withstand and to prevent the restriction of high flows, to maintain existing low flows, maintain water quality, and not obstruct the movement of aquatic life indigenous to the waterbody beyond the duration of construction.
- c. Crossings shall be installed in such a manner as to preserve hydraulic capacity and flow, sediment transport, and organism passage at its present level, between the wetlands on either side of the road. The applicant shall take necessary measures to correct any wetland damage resulting from deficiencies in hydraulic capacity, sediment transport and organism passage.
- d. Stream crossings shall utilize a natural mixed grain-size streambed material composition that matches upstream and downstream substrates to create a stable streambed. Substrate should function appropriately during normal and high flows without washing out. If natural streambed material is not utilized, a PCN is required.
- e. Activities involving open trench excavation in flowing waters require a PCN. Work should not occur in flowing waters (requires using management techniques such as temporary flume pipes, culverts, cofferdams, etc.). Normal flows should be maintained within the stream boundary’s confines when practicable. Projects utilizing these management techniques must meet all applicable terms and conditions of the GP, including the GCs in Section IV.

### **32. Utility Line Installation and Removal**

- a. Subsurface utility lines must be installed at a sufficient depth to avoid damage from anchors, dredging, etc., and to prevent exposure from erosion and stream adjustment.
- b. When utility lines are installed via horizontal directional drilling, a frac-out contingency plan shall be present on site for the duration of construction. As necessary, the applicant shall immediately contain, control, recover, and remove drilling fluids released into the environment.
- c. Abandoned or inactive utility lines must be removed and faulty lines (e.g., leaking hazardous substances, petroleum products, etc.) must be removed or repaired. A written verification from the USACE is required if they are to remain in place, e.g., to protect sensitive areas or ensure safety.
- d. Utility lines shall not adversely alter existing hydrology, and trenches cannot be constructed or backfilled in such a manner as to drain waters of the U.S. (e.g., backfilling with extensive gravel layers, creating a French drain effect). In wetland areas, structures such as ditch plugs, cut-off walls, clay blocks, bentonite, or other suitable material shall be used within utility trenches to ensure that the trench through which the utility line is installed does not drain waters of the U.S. including wetlands.
- e. Stockpiling of tree debris, to the extent where it has the effect of fill material, shall not occur in waters of the U.S. Tree debris shall be removed from waters of the U.S. and placed in uplands without causing additional disturbance to aquatic resources. Failure to meet this condition could change the bottom elevation of the wetland and be considered a discharge of fill material, and depending on the area of alteration, may require a PCN or IP.

**33. Water Supply Intakes.** No activity may occur in the proximity of a public water supply intake, except where the activity is for the repair or improvement of public water supply intake structures or adjacent bank stabilization.

**34. Coral Reefs.** Impacts to coral reefs are not authorized under these GPs. Coral reefs consist of the skeletal deposit, usually of calcareous or siliceous materials, produced by the vital activities of anthozoan polyps or other invertebrate organisms present in growing portions of the reef.

**35. Blasting.** Blasting in waters of the U.S. associated with work such as dredging, trenching, pile installation, etc. is not authorized under these GPs.

**36. Inspections.** The permittee shall allow USACE to make periodic inspections at any time deemed necessary to ensure that the work is being or has been performed in accordance with the terms and conditions of this permit. To facilitate these inspections, for activities requiring a PCN, the permittee shall complete and return the Certificate of Compliance when it is provided with a PCN verification letter. For SV-eligible activities, the permittee shall complete and submit the SVN to USACE within 30 days of initiating project construction, at which point, USACE may opt to inspect the activity to verify compliance with the terms and conditions of the GP. Post-construction engineering drawings may be required by USACE for completed work. This includes post-dredging survey drawings for any dredging work.

**37. Maintenance.** The permittee shall maintain the activity authorized by these GPs in good condition and in conformance with the terms and conditions of this permit. Some maintenance activities may not be subject to federal regulation under Section 404 in accordance with 33 CFR 323.4(a)(2). This condition is not applicable to maintenance of dredging projects. Prospective permittees should contact USACE to inquire about maintenance of dredging projects, and its eligibility under these GPs. Maintenance dredging is subject to the review thresholds in GP #7 as well as any conditions included in a written USACE authorization. Maintenance dredging includes only those areas and depths previously authorized and dredged.

**38. Property Rights.** Per 33 CFR 320.4(g)(6), these GPs do not convey any property rights, either in real estate or material, or any exclusive privileges, nor do they authorize any injury to property or invasion of rights or any infringement of Federal, State, or local laws or regulations.

**39. Transfer of GP Verifications.** When the work authorized by these GPs is still in existence at the time the property is transferred, the terms and conditions of these GPs, including any special conditions, will continue to be binding on the entity or individual who received the GP authorizations, as well as the new owner(s) of the property. If the permittee sells the property associated with a GP authorization, the applicant may transfer the GP authorization to the new owner by submitting a letter to USACE to validate the transfer. A copy of the GP authorization letter must be attached to the letter, and the letter must include the following statement: "The terms and conditions of these general permits, including any special conditions, will continue to be binding on the new owner(s) of the property." This letter shall be signed by both the seller and new property owner(s).

**40. Modification, Suspension, and Revocation.** These GPs and any individual authorization issued thereof may be either modified, suspended, or revoked in whole or in part pursuant to the policies and procedures of 33 CFR 325.7; and any such action shall not be the basis for any claim for damages against the U.S.

**41. Special Conditions.** The USACE may impose other special conditions on a project authorized pursuant to these GPs that are determined necessary to minimize adverse navigational and/or environmental effects or based on any other factor of the public interest. Failure to comply with all conditions of the authorization, including special conditions, constitutes a permit violation and may subject the applicant to criminal, civil, or administrative penalties or restoration.



**42. False or Incomplete Information.** If USACE makes a determination regarding the eligibility of a project under these GPs, and subsequently discovers that it has relied on false, incomplete, or inaccurate information provided by the applicant, the authorization will not be valid, and the U.S. Government may institute appropriate legal proceedings.

**43. Abandonment.** If the permittee decides to abandon the activity authorized under these GPs, unless such abandonment is merely the transfer of property to a third party, he/she/they may be required to restore the area to the satisfaction of USACE.

**44. Enforcement cases.** These GPs do not apply to any existing or proposed activity in USACE jurisdiction associated with an on-going USACE or EPA enforcement action, until such time as the enforcement action is resolved or USACE or EPA determines that the activity may proceed independently without compromising the enforcement action.

**45. Previously Authorized Activities.**

- a. Completed projects that received prior authorization from USACE (SV or PCN), shall remain authorized in accordance with the original terms and conditions of those authorizations, including their terms, GCs, and any special conditions provided in a written verification.
- b. Activities authorized pursuant to 33 CFR 330.3 (activities occurring before certain dates) are not affected by these GPs.

**46. Duration of Authorization.**

These GPs expire on June 1, 2028. Activities authorized under these GPs will remain authorized until the GPs expire, unless discretionary authority has been exercised on a case-by-case basis to modify, suspend, or revoke the authorization in accordance with 33 CFR 325.2(e)(2). Activities authorized under GPs 1-25 that have either commenced (i.e., are under construction) or are under contract to commence in reliance upon this authorization will have until June 1, 2029 to complete the work. If requested by USACE, the permittee shall furnish documentation that demonstrates the project was under construction or under contract to commence by June 1, 2028. If work is not completed before June 1, 2029, the permittee must contact USACE. The USACE may issue a new authorization provided the project meets the terms and conditions of the MA GPs in effect at the time. Activities completed under the SV or PCN authorizations of these GPs will continue to be authorized after their expiration date.

## **SECTION V: MITIGATION STANDARDS**

### **1. Mitigation Types**

For all activities, applicants must (a) demonstrate how the project has been designed to avoid or minimize impacts to aquatic resources; and (b) describe measures taken to avoid or minimize impacts to aquatic resources through construction techniques and/or site access. Please see <https://www.nae.usace.army.mil/Missions/Regulatory/Mitigation/> for assistance with preparing mitigation in accordance with the 2008 Compensatory Mitigation for Losses of Aquatic Resources; Final Rule (33 CFR 332.3), hereafter referred to as “2008 Mitigation Rule.”

**Avoidance** - Avoidance of impacts (direct and indirect) to aquatic resources means that project activities would not result in the placement of fill material or installation of a structure that could impact the resource area. Avoidance can include, but is not limited to, designing the project to avoid impacts to all or a portion of the aquatic resource areas.

**Minimization** - Minimization of impacts (direct and indirect) to aquatic resources means that measures are taken to ensure the amount and duration of impacts are limited to the maximum extent practicable. There are many minimization measures that could be implemented, prior to, during, or after the proposed activity, to ensure impacts are minimized. Examples include, but are not limited to:

- Permanent preservation of avoided aquatic features and buffer zone, in perpetuity. In these cases, the preserved area would be under a conservation easement and managed by conservation oriented third-party manager.
- Utilization of best management practices (BMPs) to ensure impacts are limited, and do not result in adverse impacts to the integrity and long-term functions of preserved/avoided features.

**Compensatory Mitigation** - Compensatory mitigation is generally required for PCN activities in which the impacts to the aquatic resources have been avoided and minimized to the maximum extent practicable but would still result in unavoidable adverse effects to the environment that are considered more than minimal or are contrary to the public interest. *Whatever the case may be, compensatory mitigation is no substitute for avoidance and minimization.*

### **2. Thresholds for Compensatory Mitigation**

The basic objective of compensatory mitigation in the USACE Regulatory Program is to offset environmental losses resulting from unavoidable impacts to waters of the U.S. authorized by Department of the Army permits. **The following compensatory mitigation thresholds apply to all PCN activities that result in loss<sup>1</sup> of the resource area types listed below. Activities<sup>2</sup> in waters of the U.S. associated with the restoration, enhancement, and establishment of tidal and non-tidal aquatic resources are not considered loss and are not subject to the thresholds below.** Thresholds for different resource areas may not be combined to exceed 5,000 SF of total loss of all waters. The USACE will continue to evaluate projects on a case-by-case basis, and may in some cases require compensatory mitigation below these thresholds (e.g. minor impacts that add to a cumulative loss).

<sup>1</sup> See definition of loss in Section VII.

<sup>2</sup> These activities must result in net increases in aquatic resource functions and services to be exempted from the thresholds above.

| Compensatory Mitigation Thresholds in Massachusetts |                     |                   |
|---|---------------------|-------------------|
| Resource Area                                       | Non-Tidal Threshold | Tidal Threshold   |
| Stream  | 200 LF              | 200 LF            |
| Bank Stabilization                                  | 500 LF              | 500 LF            |
| Open Water  | Project Dependent   | Project Dependent |
| Wetland   | 5,000 SF            | 500 SF            |
| Vernal Pool   | All                 | N/A               |
| SAV   | Project dependent   | 25 SF             |
| Mudflat   | N/A                 | 1,000 SF          |
| Intertidal  | N/A                 | 1,000 SF          |

These thresholds can be utilized to determine at what point compensatory mitigation is required but are not used to determine how much mitigation may be needed to offset impacts to resources. Per the 2008 Mitigation Rule (33 CFR 332.3(f)(1)) “the amount of required compensatory mitigation must be, to the extent practicable, sufficient to replace lost aquatic resource functions. In cases where appropriate functional or condition assessment methods or other suitable metrics are available, these methods should be used where practicable to determine how much compensatory mitigation is required. If a functional or condition assessment or other suitable metric is not used, a minimum one-to-one acreage or linear foot compensation ratios must be used.”

### 3. Compensatory Mitigation Hierarchy

Compensatory mitigation should follow the hierarchy as outlined in 33 CFR 332.3(b)(2-6) or current regulation. This hierarchy in order of preference includes: (1) Mitigation Bank credits, (2) In-Lieu Fee program credits, (3) permittee-responsible mitigation under a watershed approach, (4) permittee-responsible mitigation through on-site and in-kind mitigation, and (5) permittee-responsible mitigation through off-site and/or out-of-kind mitigation. If the proposed mitigation deviates from this mitigation hierarchy, the applicant **must** justify in writing why the proposed mitigation is environmentally preferable to the preferred method of compensatory mitigation (See 2008 Mitigation Rule). **In order for your application to be considered complete, you must provide a statement that discusses how your project will compensate for the loss or impact to aquatic resources.** If you are proposing permittee responsible mitigation, the 12 components of a mitigation plan (33 CFR 332.4(c)(2-14) must be addressed for your application to be considered complete. Prospective applicants are encouraged to contact USACE with questions at any time. Addressing the 12 components of a mitigation plan is commensurate with the amount of compensatory mitigation required, and USACE can assist prospective applicants with the level of information needed to satisfy each component.

For activities resulting in the loss of marine or estuarine resources, permittee-responsible mitigation may be environmentally preferable if there are no mitigation banks or in-lieu fee programs in the area that have marine or estuarine credits available for sale or transfer to the permittee.

### 4. In-Lieu Fee (ILF)

The purchase of credits from the Massachusetts In-Lieu Fee Program (MA ILFP) is the **preferred** method of compensatory mitigation in Massachusetts since, as of the issuance date of this GP, there are no mitigation banks available in Massachusetts. The applicant shall develop a mitigation plan that addresses the baseline conditions at the impact site and the number of credits to be provided (see 33 CFR 332.4(c)(1)(ii)).

The MA ILFP is administered by the Massachusetts Department of Fish & Game (DFG) in accordance with the 2008 Mitigation Rule at 33 CFR 332. The Mitigation Rule governs in-lieu fee compensatory mitigation associated with USACE permits under §404 of the Clean Water Act and/or §9 or §10 of the Rivers and Harbors Act of 1899.

MA ILFP Website: <https://www.mass.gov/in-lieu-fee-program>

Acceptance of an ILF payment into the ILFP established by the 2014 MA ILFP Instrument (link below) is an acknowledgement by DFG that it assumes all legal responsibility for satisfying the mitigation requirements of the USACE (i.e., the implementation, performance, and long-term management and monitoring of the compensatory mitigation project(s) approved under this Instrument and subsequent Compensatory Mitigation Plans). This transfer of legal responsibility is established by: 1) the approval of this In-Lieu Fee Instrument; 2) receipt by the district engineer of a Notice of Credit Sale and Transfer of Legal Responsibility to DFG that is signed by the DFG and the permittee and dated; and 3) the transfer of fees from the permittee to DFG.

MA ILFP Fact Sheet: <https://www.mass.gov/files/documents/2017/01/sj/ilfp-fact-sheet-ma-ilfp-fees.pdf>

MA ILFP Instrument: <https://www.mass.gov/files/documents/2016/08/nd/ilfp-final-instrument-dfg.pdf>

## **5. Permittee-Responsible**

The USACE may determine that the proposed permittee-responsible compensatory mitigation is appropriate on a case-by-case basis. As described in the Compensatory Mitigation Hierarchy section above, applicants must justify in writing why the proposed mitigation is environmentally preferable to the purchase of ILF credits. Applicants are encouraged to contact the USACE prior to submission of a permit application to seek further guidance regarding USACE mitigation requirements.

Applicants will demonstrate their proposed compensatory mitigation in writing by addressing the 12 components of a mitigation plan (33 CFR 332.4(c)(2-14)). *Please note that all elements must be addressed, or the permit application will be deemed incomplete.* In certain circumstances, the district engineer may determine that prior approval of the final mitigation plan is not practicable or not necessary to ensure timely completion of the required compensatory mitigation (see 33 CFR 332.3(k)(3)). Guidance on how to address these components can be found on the New England District Mitigation webpage: <https://www.nae.usace.army.mil/Missions/Regulatory/Mitigation/>

Performance standards will be used to measure the successfulness of the mitigation project. A successful mitigation project is one that is self-sustaining. For a mitigation project that will restore, enhance, or create wetlands, proper performance standards must address hydrology, hydric soils, and hydrophytic vegetation. The mitigation proposal must include an explanation of quantitative methods used to measure the success of performance standards (i.e., percent cover may be measured using vegetation plots, hydrology may be measured using data loggers, soil cores may be taken and evaluated for hydric soil indicators).

Monitoring methods should include quantitative sampling methods following established, scientific protocols. Sampling documentation, as part of monitoring reports, should include maps and coordinates (also shapefiles, if available) showing locations of sampling points, transects, quadrats, etc. In addition, permanent photo stations should be established coincident with sampling locations.

## SECTION VI: FEDERAL & STATE AGENCY CONTACT INFORMATION & ORGANIZATIONAL WEBSITES

### Federal Agencies

#### U.S. Army Corps of Engineers

Regulatory Division  
696 Virginia Road  
Concord, Massachusetts 01742-2751  
(978) 318-8338 (phone); (978) 318-8303 (fax)  
[www.nae.usace.army.mil/missions/regulatory](http://www.nae.usace.army.mil/missions/regulatory)

#### U.S. Army Corps of Engineers

Navigation Division – Section 408  
696 Virginia Road  
Concord, Massachusetts 01742-2751  
*See link below for contact information:*  
<https://www.nae.usace.army.mil/Missions/Section-408/>

#### National Marine Fisheries Service

55 Great Republic Drive  
Gloucester, Massachusetts 01930  
(978) 281-9300 (phone)  
*(Federal endangered species & EFH)*

#### U.S. Fish & Wildlife Service

70 Commercial Street, Suite 300  
Concord, New Hampshire 03301  
(603) 223-2541 (phone)  
*(Federal endangered species)*

#### National Park Service

15 State Street  
Boston, Massachusetts 02109  
(617) 223-5191 (phone)  
*(Wild and Scenic Rivers)*

#### Bureau of Ocean and Energy Management

1849 C Street, NW  
Washington D.C. 20240  
202-208-6474 (phone)  
*(Offshore Wind Facilities)*

#### Chief, Risk Analysis Branch

FEMA Region 1  
99 High Street, 6th Floor  
U.S. Department of Homeland Security  
Boston, Massachusetts 02110  
(617) 956-7576 (phone)

#### Commander (dpb)

First Coast Guard District  
Battery Building  
One South Street  
New York, New York 10004-1466  
(212) 514-4331 (phone); (212) 514-4337 (fax)  
*(Bridge permits)*

#### U.S. Environmental Protection Agency

5 Post Office Square  
Suite 100 (OEP06-3)  
Boston, Massachusetts 02109-3912  
(617) 918-1692 (phone)

**State Agencies in Massachusetts**

| <u>Massachusetts Department of Environmental Protection (MassDEP)</u> |   |
|---|---|
| <u>DEP Division of Wetlands &amp; Waterways</u>                       | 100 Cambridge Street, Suite 900<br>Boston, Massachusetts 02114<br>(617) 292-5695  |
| <u>Northeast Region</u>   | 150 Presidential Way, Suite 300<br>Woburn, Massachusetts 01801<br>(978) 694-3200  |
| <u>Southeast Region</u>   | 20 Riverside Drive, Route 105<br>Lakeville, Massachusetts 02347<br>(508) 946-2800 |
| <u>Central Region</u>   | 8 New Bond Street<br>Worcester, Massachusetts 01606<br>(508) 792-7650             |
| <u>Western Region</u>   | 436 Dwight Street<br>Springfield, Massachusetts 01103<br>(413) 784-1100           |

| <u>Massachusetts Office of Coastal Zone Management (CZM)</u>          |  |
|---|--|
| Emails may be sent to: <a href="mailto:czm@mass.gov">czm@mass.gov</a> |  |
| <u>MA Office of Coastal Zone Management</u>                           | 100 Cambridge Street, Suite 900<br>Boston, Massachusetts 02114<br>(617) 626-1200 |
| <u>North Shore Region</u>   | 2 State Fish Pier<br>Gloucester, Massachusetts 01930<br>(978) 281-3972           |
| <u>South Shore Region</u>   | 175 Edward Foster Road<br>Scituate, Massachusetts 02066                          |
| <u>Cape Cod and Islands Region</u>                                    | 3195 Main Street, P.O. Box 220<br>Barnstable, MA 02630                           |
| <u>South Coastal Region</u>   | 81-B County Road, Suite E<br>Mattapoisett, MA 02739                              |

| <u>Massachusetts Historical Commission (MHC)</u> |  |
|--|--|
| Office Location:                                 | 220 Morrissey Boulevard<br>Boston, Massachusetts 02125<br>(617) 727-8470 |

| <u>Massachusetts Board of Underwater Archaeological Resources (BUAR)</u>                        |  |
|---|--|
| Emails may be sent to: <a href="mailto:david.s.robinson@mass.gov">david.s.robinson@mass.gov</a> |  |
| Office Location:  | 100 Cambridge Street, Suite 900<br>Boston, Massachusetts 02114<br>(617) 626-1014 |

## **SECTION VII: Definitions & Acronyms**

**Artificial or Living Reef:** A structure which is constructed or placed in waters for the purpose of enhancing fishery resources and commercial and recreational fishing opportunities.

**Attendant Features:** Occurring with or as a result of; accompanying.

**Biodegradable:** A material that decomposes into elements found in nature within a reasonably short period of time and will not leave a residue of plastic or a petroleum derivative in the environment after degradation. In contrast, degradable plastics break down into plastic fragments that remain in the environment after degradation. Examples of biodegradable materials include jute, sisal, cotton, straw, burlap, coconut husk fiber (coir) or excelsior. In contrast, degradable plastics break down into plastic fragments that remain in the environment after degradation. Photodegradable, UV degradable or Oxo-(bio)degradable plastics are not considered biodegradable under this GP.

**Boating facilities:** These provide, rent or sell mooring space, such as marinas, yacht clubs, boat yards, dockminiums, municipal facilities, land/home owners, etc. Not classified as boating facilities are piers shared between two abutting properties or municipal mooring fields that charge an equitable user fee based on the actual costs incurred.

**Compensatory mitigation:** The restoration (re-establishment or rehabilitation), establishment (creation), enhancement, and/or in certain circumstances preservation of aquatic resources for the purposes of offsetting unavoidable adverse impacts which remain after all appropriate and practicable avoidance and minimization has been achieved. Must comply with the applicable provisions of 33 CFR 332. See also the New England District Compensatory Mitigation Guidance at <http://www.nae.usace.army.mil/Missions/Regulatory/Mitigation.aspx>.

**Construction mats:** Constructions, swamp and timber mats (herein referred to as "construction mats") are generic terms used to describe structures that distribute equipment weight to prevent wetland damage while facilitating passage and providing work platforms for workers and equipment. They are comprised of sheets or mats made from a variety of materials in various sizes. A timber mat consists of large timbers bolted or cabled together. Corduroy roads, which are not considered to be construction mats, are cut trees and/or saplings with the crowns and branches removed, and the trunks lined up next to one another. Corduroy roads are typically installed as permanent structures. Like construction mats, they are considered as fill whether they are installed temporarily or permanently.

**Cumulative Impacts:** The impact on the environment, which results from the incremental impact of the action when added to other past, present, and reasonably foreseeable future actions, regardless of what agency or person undertakes such other actions. Cumulative impacts can result from individually minor but collectively significant actions taking place over a period of time (40 CFR 1508.1). Although the impact of a particular discharge may constitute a minor change in itself, the cumulative effect of numerous such piecemeal changes can result in a major impairment of the water resources and interfere with the productivity and water quality of existing aquatic ecosystems. See 40 CFR 230.11(g).

**Currently serviceable:** Useable as is or with some maintenance, but not so degraded as to essentially require reconstruction.

### **Dredging:**

**Improvement Dredging:** For the purposes of these GPs, this is dredging deeper than previously authorized by the USACE and dredged under that authorization.

**Maintenance Dredging:** For the purposes of these GPs, this is dredging from an area previously authorized by the USACE and dredged under that authorization. The USACE may require proof of authorization and dredging. Maintenance dredging typically refers to the routine removal of accumulated sediment to maintain the design depths of serviceable navigation channels, harbors, marinas, boat launches and port facilities. Maintenance dredging is conducted for navigational purposes and does not include any expansion of the previously dredged area. The USACE may

review a maintenance dredging activity as new dredging if sufficient time has elapsed to allow for the colonization of SAS, shellfish, etc.

**New Dredging:** For the purposes of these GPs, this is a) first time the USACE authorizes dredging of a particular location or b) dredging has not occurred for an extended period of time, and this has allowed for aquatic resources (i.e., eelgrass, shellfish, etc.) to redevelop in the area.

**Dredged material & discharge of dredged material:** These are defined at 33 CFR 323.2(c) and (d). The term dredged material means material that is excavated or dredged from waters of the U.S.

**Enhancement:** The manipulation of the physical, chemical, or biological characteristics of an aquatic resource to heighten, intensify, or improve a specific aquatic resource function(s). Enhancement results in the gain of selected aquatic resource function(s) but may also lead to a decline in other aquatic resource function(s). Enhancement does not result in a gain in aquatic resource area.

**Ephemeral stream:** A stream with flowing water only during, and for a short duration, after precipitation events in a typical year. Ephemeral stream beds are located above the water table year-round. Groundwater is not a source of water for the stream. Runoff from rainfall is the primary source of water for stream flow.

**Erosion Controls:** Appropriate soil erosion, sediment and turbidity controls include cofferdams, bypass pumping around barriers immediately up and downstream of the work footprint (i.e., dam and pump), installation of sediment control barriers (i.e., silt fence, vegetated filter strips, geotextile silt fences, filter tubes, erosion control mixes, hay bales or other devices) downhill of all exposed areas, stream fords, retention of existing vegetated buffers, application of temporary mulching during construction, phased construction, and permanent seeding and stabilization, etc.

**Establishment (creation):** The manipulation of the physical, chemical, or biological characteristics present to develop an aquatic resource that did not previously exist at an upland site. Establishment results in a gain in aquatic resource area (33 CFR 332.2).

**Expansions:** Work that increases the footprint of fill, structures, depth of basin or drainage features, or floats, or slip capacity.

**Essential Fish Habitat (EFH):** The Federal Magnuson-Stevens Fishery Management and Conservation Act broadly defines EFH to include those waters and substrate necessary to fish for spawning, breeding, feeding, or growth to maturity. See

[www.greateratlantic.fisheries.noaa.gov/habitat](http://www.greateratlantic.fisheries.noaa.gov/habitat) for more information.

**Fill material & discharge of fill material:** Material placed in waters of the U.S. where the material has the effect of either replacing any portion of a water of the U.S. with dry land or changing the bottom elevation of any portion of a water of the U.S. Fill material does not include any pollutant discharged into the water primarily to dispose of waste. These are defined at 33 CFR 323.2 (e) & (f).

**Federal navigation projects (FNPs):** These areas are maintained by the USACE; authorized, constructed and maintained on the premise that they will be accessible and available to all on equal terms; and comprised of USACE Federal anchorages, Federal channels and Federal turning basins. The buffer zone is equal to three times the authorized depth of a FNP. The following are FNPs in MA and more information, including the limits, is provided at

[www.nae.usace.army.mil/missions/navigation](http://www.nae.usace.army.mil/missions/navigation) >> Navigation Projects:

|                            |                             |                                |
|----------------------------|-----------------------------|--------------------------------|
| Andrews River, Harwich, MA | Cross Rip Shoals, Nantucket | Gloucester Harbor and          |
| Aunt Lydia's Cove          | Sound                       | Annisquam River                |
| Beverly Harbor             | Cuttyhunk Harbor            | Green Harbor                   |
| Boston Harbor              | Dorchester Bay and Neponset | Hingham Harbor                 |
| Buttermilk Bay Channel     | River                       | Hyannis Harbor                 |
| Canapitsit Channel         | Duxbury Harbor              | Ipswich River                  |
| Cape Cod Canal             | Edgartown Harbor            | Island End River (Chelsea, MA) |
| Chatham Harbor             | Essex River                 | Kingston Harbor                |
| Cohasset Harbor            | Fall River Harbor           | Lagoon Pond                    |
|                            | Falmouth Harbor             | Little Harbor Woods Hole       |



Lynn Harbor  
 Malden River  
 Menemsha Creek  
 Merrimack River  
 Mystic River  
 Nantucket Harbor of Refuge  
 New Bedford and Fairhaven Harbor  
 Newburyport Harbor  
 Oak Bluffs Harbor  
 Pigeon Cove Harbor

Plymouth Harbor  
 Pollock Rip Shoals, Nantucket Sound  
 Provincetown Harbor  
 Red Brook Harbor  
 Rockport Harbor  
 Salem Harbor  
 Sandy Bay Harbor of Refuge  
 Saugus River  
 Scituate Harbor  
 Sesuit Harbor

Taunton River  
 Vineyard Haven Harbor  
 Wareham Harbor  
 Wellfleet Harbor  
 Westport River and Harbor  
 Weymouth Back River  
 Weymouth Fore and Town Rivers  
 Winthrop Harbor  
 Woods Hole Channel

**Flume:** An open artificial water channel, in the form of a gravity chute, which leads water from a diversion dam or weir alongside a natural flow. A flume can be used to measure the rate of flow.

**FNP buffer zone:** The buffer zone of a USACE Federal Navigation Project (FNP) is equal to three times the authorized depth of the FNP.

**Frac out:** During horizontal directional drilling (HDD) operations, drilling fluid travels up the borehole into a pit. When the borehole becomes obstructed or the pressure becomes too great inside the borehole, the ground fractures and fluid escapes to the surface and may affect surface waters.

**Ground disturbance:** Any activity that compacts, relocates, overturns, removes, mixes, or otherwise disturbs the ground, including under water. Ground disturbance can be caused by the use of hand tools (shovels, pick axe, posthole digger, etc.), heavy equipment (excavators, backhoes, bulldozers, dredgers, trenching and earthmoving equipment, etc.), and heavy trucks (large four wheel drive trucks, dump trucks and tractor trailers, etc.). Trenching, bulldozing, dredging, excavating, scraping, and plowing are typical examples of ground disturbance activities.

**Height:width ratio:** The height of structures shall at all points be equal to or exceed the width of the deck. For the purpose of this definition, height shall be measured from the marsh substrate to the bottom of the longitudinal support beam.

**High Tide Line (HTL):** The line of intersection of the land with the water's surface at the maximum height reached by a rising tide. The high tide line may be determined, in the absence of actual data, by a line of oil or scum along shore objects, a more or less continuous deposit of fine shell or debris on the foreshore or berm, other physical markings or characteristics, vegetation lines, tidal gages, or other suitable means that delineate the general height reached by a rising tide. The line encompasses spring high tides and other high tides 58 that occur with periodic frequency but does not include storm surges in which there is a departure from the normal or predicted reach of the tide due to the piling up of water against a coast by strong winds. (33 CFR 328). Refer to the highest predicted tide for the current year at the nearest NOAA tide gage. <https://tidesandcurrents.noaa.gov/map/index.html>

**Historic Property:** Any prehistoric or historic site (including archaeological sites), district, building, structure, or other object included in, or eligible for inclusion in, the National Register of Historic Places maintained by the Secretary of the Interior. This term includes artifacts, records, and remains that are related to and located within such properties. The term includes properties of traditional religious and cultural importance to an Indian tribe or Native Hawaiian organization and that meet the National Register criteria (36 CFR part 60).

**Impacts:**

Direct Impacts: Effects that are caused by the activity and occur at the same time and place (40 CFR 1508.7).

Indirect impacts: Effects that are caused by the activity and are later in time or farther removed in distance, but are still reasonably foreseeable.

Secondary impacts: Effects on an aquatic ecosystem that are associated with a discharge of dredged or fill materials, but do not result from the actual placement of the dredged or fill material.

Information about secondary effects on aquatic ecosystems shall be considered prior to the time final section 404 action is taken by permitting authorities. Some examples of secondary effects on an aquatic ecosystem are: aquatic areas drained, flooded, fragmented; fluctuating water levels in an impoundment and downstream associated with the operation of a dam; septic tank leaching and surface runoff from residential or commercial developments on fill; and leachate and runoff from a sanitary landfill located in waters of the U.S. See 40 CFR 230.11(h).

**Incidental Fallback:** Incidental fallback is the redeposit of small volumes of dredged material that is incidental to excavation activity in waters of the U.S. when such material falls back to substantially the same place as the initial removal (33 CFR 323.2(d)(2)(iii)).

**In the dry:** Work that is done under dry conditions, e.g., work behind cofferdams or when the stream or tide is waterward of the work.

**Independent utility:** A test to determine what constitutes a single and complete non-linear project in the USACE Regulatory Program. A project is considered to have independent utility if it would be constructed absent the construction of other projects in the project area. Portions of a multi-phase project that depend upon other phases of the project do not have independent utility. Phases of a project that would be constructed even if the other phases were not built can be considered as separate single and complete projects with independent utility.

**Individual permit:** A Department of the Army authorization that is issued following a case-by-case evaluation of a specific structure or work in accordance with the procedures of 33 CFR 322, or a specific project involving the proposed discharge(s) in accordance with the procedures of 33 CFR 323, and in accordance with the procedures of 33 CFR 325 and a determination that the proposed discharge is in the public interest pursuant to 33 CFR 320.

**Intermittent stream:** An intermittent stream has flowing water during certain times of the year, when groundwater provides water for stream flow. During dry periods, intermittent streams may not have flowing water. Runoff from rainfall is a supplemental source of water for stream flow.

**Intertidal:** The area in between mean low water and the high tide line.

**Living reef:** See the definition of "artificial or living reef."

**Living shoreline:** A term used to describe a low-impact approach with a substantial biological component to shoreline protection and restoration along coastal shores, riparian zones, lacustrine fringe wetlands, or oyster or mussel reef structures. This approach integrates natural features to restore, enhance, maintain, or create habitat, functions, and processes while also functioning to mitigate flooding or shoreline erosion. Living shorelines may stabilize banks and shores with small fetch and gentle slopes that are subject to low-to mid-energy waves. A living shoreline has a footprint that is made up mostly of native material. It incorporates vegetation or other living, natural "soft" elements alone or in combination with some type of harder shoreline structure (e.g., oyster or mussel reefs or rock sills) for added protection and stability. Living shorelines should maintain the natural continuity of the land-water interface and retain or enhance shoreline ecological processes.

**Loss of waters of the United States:** Waters of the U.S. that are permanently adversely affected by filling, flooding, excavation, or drainage because of the regulated activity. The loss of stream bed includes the acres of stream bed that are permanently adversely affected by filling or excavation because of the regulated activity. Permanent adverse effects include permanent discharges of dredged or fill material that change an aquatic area to dry land, increase the bottom elevation of a waterbody, or change the use of a waterbody. The acreage of loss of waters of the U.S. is a threshold measurement of the impact to jurisdictional waters or wetlands for determining whether a project may qualify for a GP; it is not a net threshold that is calculated after considering compensatory mitigation that maybe used to offset losses of aquatic functions and services. Waters of the U.S. temporarily filled, flooded, excavated, or drained, but restored to pre-construction contours and elevations after construction, are not included in the measurement of loss of waters of the U.S. Impacts resulting from activities that do not require Department of the Army authorization, such as activities eligible for exemptions under section 404(f) of the Clean Water Act, are not considered when calculating the loss of waters of the U.S.

**Maintenance:** The repair, rehabilitation, or in-kind replacement of any previously authorized, currently serviceable structure or fill, or of any currently serviceable structure or fill authorized by 33 CFR 330.3 – “Activities occurring before certain dates,” provided that the structure or fill is not to be put to uses differing from those uses specified or contemplated for it in the original permit or the most recently authorized modification. Maintenance includes minor deviations in the structure’s configuration or filled area, including those due to changes in materials, construction techniques, or current construction codes or safety standards that are necessary to make repair, rehabilitation, or replacement are authorized. Currently serviceable means useable as is or with some maintenance, but not so degraded as to essentially require reconstruction.

**Maintenance Exemption:** In accordance with 33 CFR 323.4(a)(2), any discharge of dredged or fill material that may result from any of the following activities is not prohibited by or otherwise subject to regulation under Section 404 of the CWA: “Maintenance, including emergency reconstruction of recently damaged parts, of currently serviceable structures such as dikes, dams, levees, groins, riprap, breakwaters, causeways, bridge abutments or approaches, and transportation structures. Maintenance does not include any modification that changes the character, scope, or size of the original fill design.”

**Mean high water:** Line on the shore reached by the plane of the average high water. Where precise determination of the actual location of the line becomes necessary, it must be established by survey with reference to the available tidal datum, preferably averaged over a period of 18.6 years. Less precise methods, such as observation of the “apparent shoreline” which is determined by reference to physical markings, lines of vegetation, or changes in type of vegetation, may be used only where an estimate is needed of the line reached by the mean high water.

**Mechanized land clearing:** Land clearing activities using mechanized equipment such as backhoes or bulldozers with shear blades, rakes or discs constitute point source discharges and are subject to section 404 jurisdiction when they take place in wetlands or waters of the U.S (Regulatory Guidance Letter 90-05).

**Metallic mineral:** Any ore or material to be excavated from the natural deposits on or in the earth for its metallic mineral content to be used for commercial or industrial purposes. “Metallic mineral” does not include thorium or uranium.

**Minor deviations:** Deviations in the structure’s configuration or filled area, including those due to changes in materials, construction techniques, or current construction codes or safety standards, which are necessary to make repair, rehabilitation, or replacement are permitted, provided the adverse environmental effects resulting from such repair, rehabilitation, or replacement are minimal.

**Natural Rocky Habitats:** Intertidal and subtidal substrates of pebble-gravel, cobble, boulder, or rock ledge and outcrops. Manufactured stone (e.g., cur or engineered riprap) is not considered a natural rocky habitat. Natural rocky habitats are either found as pavement (consolidated pebble-gravel, cobble, or boulder areas) or as a mixture with fines (i.e., clay and sand) and other substrates. Rocky habitats as EFH are defined as follows: (1) All pebble-gravel, cobble, or boulder pavements; (2) Pebble-gravel mixed with fines: mixed substrate of pebble-gravel and fines where pebble-gravel is an evident component of the substrate (either through visual observation or within sediment samples). Sediment samples with a content of 10% or more of pebble-gravel in the top layer (6-12 inches) should be delineated; (3) Scattered cobble, scattered boulder, scattered cobble/boulder: mixed substrate of cobble and/or boulder and other substrates. The aerial extent of cobbles and/or boulders should be delineated; and (4) All rock ledge outcrops: area should be delineated along the edge of the ledge/outcrop (as defined by NMFS Habitat and Ecosystems Services Branch, Gloucester, MA).

**Navigable waters or Navigable waters of the U.S.:** These waters are subject to section 10 of the Rivers and Harbors Act of 1899 and are defined as those waters that are subject to the ebb and flow of the tide and/or are presently used, or have been used in the past, or may be susceptible for use to transport interstate or foreign commerce (33 CFR Part 329). Work or structures in navigable

waters require permits pursuant to §9 and §10 of the Rivers and Harbors Act of 1899. Also see the definition of “waters of the U.S.” below.

Note: Currently the following non-tidal waters have been determined to be navigable waters of the U.S. subject to permit jurisdiction in Massachusetts: Merrimack River, Connecticut River, and Charles River to the Watertown Dam.

**Nearshore disposal:** This is defined in the USACE Coastal Engineering Manual as “(1) In beach terminology an indefinite zone extending seaward from the shoreline well beyond the breaker zone. (2) The zone which extends from the swash zone to the position marking the start of the offshore zone, typically at water depths of the order of 20m.” A nearshore berm is an artificial berm built in shallow water using dredged material. Often, the berm is intended to renourish the adjacent and downdrift shore over time under the influence of waves and currents.

**Non-regulated activity:** Only structures or fills that were previously authorized and are in compliance with the terms and condition of the original authorization can be maintained as a non-regulated activity under 33 CFR 323.4(a)(2). Minor deviations from the previously authorized footprint do not qualify as a non-regulated activity and require new authorization from the USACE. The state’s maintenance provisions may differ from the USACE and a project may require reporting and written authorization from the state.

**Non-tidal wetlands:** A non-tidal wetland is a wetland that is not subject to the ebb and flow of tidal waters. Non-tidal wetlands contiguous to tidal waters are located landward of the HTL (*i.e.*, spring HTL). Also see the definition of “Waters of the U.S.” below.

**Oil or natural gas pipeline:** Any pipe or pipeline for the transportation of any form of oil or natural gas, including products derived from oil or natural gas, such as gasoline, jet fuel, diesel fuel, heating oil, petrochemical feedstocks, waxes, lubricating oils, and asphalt.

**Ordinary High Water Mark (OHWM):** A line on the shore established by the fluctuations of water and indicated by physical characteristics, or by other appropriate means that consider the characteristics of the surrounding areas. See 33 CFR 328.3(e).

**Overall project:** The overall project, for purposes of these GPs, includes all regulated activities that are reasonably related and necessary to accomplish the project purpose. Also see the definition of “single and complete linear project.”

**Perennial stream:** A perennial stream has flowing water year-round during a typical year. The water table is located above the stream bed for most of the year. Groundwater is the primary source of water for stream flow. Runoff from rainfall is a supplemental source of water for stream flow.

**Practicable:** Available and capable of being done after taking into consideration cost, existing technology, and logistics in light of overall project purposes.

**Permanent impacts:** Permanent impacts means waters of the U.S. that are permanently affected by filling, flooding, excavation, or drainage because of the regulated activity. Permanent impacts include permanent discharges of dredged or fill material that change an aquatic area to dry land, increase the bottom elevation of a waterbody, or change the use of a waterbody.

**Preconstruction notification (PCN):** A request submitted by the applicant to the USACE for confirmation that a particular activity is authorized by these GPs. The request may be a permit application, letter, or similar document that includes information about the proposed work and its anticipated environmental effects. Preconstruction notification may be required by the terms and conditions of these GPs. A PCN may be voluntarily submitted in cases where PCN is not required and the applicant wants confirmation that the activity is authorized under these GPs.

**Preservation:** The removal of a threat to, or preventing the decline of, aquatic resources by an action in or near those aquatic resources. This term includes activities commonly associated with the protection and maintenance of aquatic resources through the implementation of appropriate legal and physical mechanisms. Preservation does not result in a gain of aquatic resource area or functions (33 CFR 332.2).

**Real estate subdivision:** Includes circumstances where a landowner or developer divides a tract of land into smaller parcels for the purpose of selling, conveying, transferring, leasing, or

developing said parcels. This would include the entire area of a residential, commercial or other real estate subdivision, including all parcels and parts thereof

**Reconfiguration zone:** A USACE authorized area in which permittees may rearrange pile-supported structures and floats without additional authorizations. A reconfiguration zone does not grant exclusive privileges to an area or an increase in structure or float area.

**Re-establishment:** The manipulation of the physical, chemical, or biological characteristics of a site with the goal of returning natural/ historic functions to a former aquatic resource. Re-establishment results in rebuilding a former aquatic resource and results in again in aquatic resource area and functions (33 CFR 332.2).

**Reference Site:** Reference sites - Compensatory restoration, rehabilitation, and creation mitigation projects should seek to duplicate the features of reference aquatic resources or enhance connectivity with adjacent natural upland and aquatic resource landscape elements. Performance standards related to reference sites are encouraged. Mitigation project sites must be selected based on their ability to be, and continue to be, resistant to disturbance from the surrounding landscape, by locating them adjacent to refuges, buffers, green spaces, and other preserved natural elements of the landscape. In general, aquatic resource mitigation projects must be designed to be self-sustaining, natural systems within the landscape and climate in which they are located, with little or no ongoing maintenance and/or hydrologic manipulation.

**Rehabilitation:** The manipulation of the physical, chemical, or biological characteristics of a site with the goal of repairing natural/historic functions to a degraded aquatic resource. Rehabilitation results in a gain in aquatic resource function, but does not result in a gain in aquatic resource area (33 CFR 332.2).

**Restoration:** The manipulation of the physical, chemical, or biological characteristics of a site with the goal of returning natural/historic functions to a former or degraded aquatic resource. For the purpose of tracking net gains in aquatic resource area, restoration is divided into two categories: re-establishment and rehabilitation (33 CFR 332.2).

**Riffle and pool complex:** Riffle and pool complexes are special aquatic sites under the 404(b)(1) Guidelines. Riffle and pool complexes sometimes characterize steep gradient sections of streams. Such stream sections are recognizable by their hydraulic characteristics. The rapid movement of water over a coarse substrate in riffles results in a rough flow, a turbulent surface, and high dissolved oxygen levels in the water. Pools are deeper areas associated with riffles. A slower stream velocity, a streaming flow, a smooth surface, and a finer substrate characterize pools.

**Sedimentation:** Sedimentation is defined as the process of deposition of a solid material from a state of suspension. Deposited sediments may accumulate and have temporal impacts to aquatic resource areas. See secondary effects definition above. For the purposes of this document, "greater than minimal sedimentation" is generally not considered to occur when using proper erosion controls (GC 25) or when sedimentation is considered "de minimis" 33 CFR 323.2(d)(5).

**Single and complete linear project:** A linear project is a project constructed for the purpose of getting people, goods, or services from a point of origin to a terminal point, which often involves multiple crossings of one or more waterbodies at separate and distant locations. The term "single and complete project" is defined as that portion of the total linear project proposed or accomplished by one owner/ developer or partnership or other association of owners/developers that includes all crossings of a single water of the U.S. (i.e., a single waterbody) at a specific location. For linear projects crossing a single or multiple waterbodies several times at separate and distant locations, each crossing is considered a single and complete project for the purposes of these GPs. However, individual channels in a braided stream or river, or individual arms of a large, irregularly shaped wetland or lake, etc., are not separate waterbodies, and crossings of such features cannot be considered separately.

**Single and complete non-linear project:** For non-linear projects, the term "single and complete project" is defined at 33 CFR 330.2(i) as the total project proposed or accomplished by one owner/developer or partnership or other association of owners/developers. A single and complete

non-linear project must have independent utility (see the definition of “independent utility”). Single and complete non-linear projects may not be “piecemealed” to avoid the limits in a GP authorization.

**Special aquatic sites (SAS):** These include inland and saltmarsh wetlands, mud flats, vegetated shallows, sanctuaries and refuges, coral reefs, and riffle and pool complexes. These are defined at 40 CFR 230.3 and listed in 40 CFR 230 Subpart E.

**Streambed:** The stream substrate between the OHW marks on each side. The substrate may be bedrock or inorganic particles that range in size from clay to boulders. Wetlands contiguous to the streambed, but outside of the OHW marks, are not considered part of the streambed.

**Stream channelization:** The manipulation of a stream’s course, condition, capacity, or location that causes more than minimal interruption of normal stream processes. A channelized stream remains a water of the U.S.

**Structure:** An object that is arranged in a definite pattern of organization. Examples of structures include, without limitation, any pier, boat dock, boat ramp, wharf, dolphin, weir, boom, breakwater, bulkhead, revetment, riprap, jetty, artificial island, artificial reef, permanent mooring structure, power transmission line, permanently moored floating vessel, piling, aid to navigation, or any other manmade obstacle or obstruction.

**Temporal loss:** The time lag between the loss of aquatic resource functions caused by the permitted impacts and the replacement of aquatic resource functions at the compensatory mitigation site(s) (33 CFR 332.2).

**Temporary impacts:** Temporary impacts include, but are not limited to, jurisdictional waters that are temporarily filled, flooded, excavated, or drained because of the regulated activity. Impacts are considered temporary when they are removed immediately upon completion of the activity. Note: An impact is considered temporary when the aquatic resource is restored to pre-project conditions, but effects to archaeological and/or cultural resources may be permanent in duration.

**Tidal wetlands:** A wetland that is subject to the ebb and flow of the tide. See the definition of “Waters of the U.S.” below.

**Tide gates:** Structures such as duckbills, flap gates, manual and self-regulating tide gates, etc. that regulate or prevent upstream tidal flows.

**Turbidity:** A measure of the level of particles such as sediment, plankton, or organic by-products, in a body of water. As the turbidity of water increases, it becomes denser and less clear due to a higher concentration of these light-blocking particles. Suspended solids are more likely to carry toxic chemicals, and can also negatively affect aquatic organisms, water temperature, and dissolved oxygen levels.

**Utility line:** Any pipe or pipeline for the transportation of any gaseous, liquid, liquescent, or slurry substance, for any purpose that is not oil, natural gas, or petrochemicals. A utility line also includes any cable, line, or wire for the transmission for any purpose of electrical energy, telephone, and telegraph messages, and radio and television communication. The term ‘utility line’ does not include activities that drain a water of the U.S., such as drainage tile or French drains, but it does apply to pipes conveying drainage from another area.

**Vegetated shallows:** Permanently inundated areas that under normal circumstances support communities of rooted aquatic vegetation, such as eelgrass (*Zostera marina*) and widgeon grass (*Ruppia maritima*) in marine systems (does not include salt marsh) as well as a number of freshwater species in rivers and lakes. These are a type of SAS defined at 40 CFR 230.43. Vegetated shallows are commonly referred to as submerged aquatic vegetation or SAV. Vegetated shallow survey guidance is located at [www.nae.usace.army.mil/missions/regulatory/jurisdiction-and-wetlands](http://www.nae.usace.army.mil/missions/regulatory/jurisdiction-and-wetlands). Maps of vegetated shallows in Massachusetts are located at [www.nae.usace.army.mil/missions/regulatory/state-general-permits/massachusetts-general-permit](http://www.nae.usace.army.mil/missions/regulatory/state-general-permits/massachusetts-general-permit).

**Vernal pools:** For the purposes of these GPs, vernal pools are depressional wetland basins that typically dry up in most years and may contain inlets or outlets, typically of intermittent flow. Vernal pools range in both size and depth depending upon landscape position and parent material(s). In

most years, vernal pools support one or more of the following obligate indicator species: wood frog, spotted salamander, blue-spotted salamander, marbled salamander, Jefferson's salamander and fairy shrimp. However, they should preclude sustainable populations of predatory fish.

**Water diversions:** Water diversions are activities such as bypass pumping (e.g., "dam and pump") or water withdrawals. Temporary flume pipes, culverts or cofferdams where normal flows are maintained within the stream boundary's confines aren't water diversions. "Normal flows" are defined as no change in flow from pre-project conditions.

**Waters of the United States (U.S.)** These waterbodies are the waters where permits are required for the discharge of dredged or fill material pursuant to §404 of the CWA. These waters include but are not limited to navigable waters of the U.S. and tidal wetlands and include many non-tidal wetlands and other waterbodies. See definitions for navigable waters of the U.S., tidal wetlands, waterbody, and non-tidal wetlands. (33 CFR 328)

**Waterbody:** Examples of "waterbodies" include oceans, coastal waters, rivers, streams, ditches, lakes, ponds, and wetlands. If a wetland is adjacent to a waterbody determined to be a water of the U.S., that waterbody and any adjacent wetlands are considered together as a single aquatic unit (see 33 CFR 328.4(c)(2)).

**Weir:** A barrier across a river designed to alter the flow characteristics. In most cases, weirs take the form of a barrier, smaller than most conventional dams, across a river that causes water to pool behind the structure and allows water to flow over the top. Weirs are commonly used to alter the flow regime of a river, prevent flooding, measure discharge and help render a river navigable.

**Wetland:** Wetlands are areas that are inundated or saturated by surface or ground water at a frequency and duration sufficient to support, and that under normal circumstances do support, a prevalence of vegetation typically adapted for life in saturated soil conditions. Wetlands generally include swamps, marshes, bogs, and similar areas. The Corps of Engineers Wetlands Delineation Manual in conjunction with the associated regional supplement should be used to determine if a wetland is present and delineate wetland boundaries.

**Acronyms**

|         |  |
|---------|--|
| BMPs    | Best Management Practices                                  |
| BUAR    | Massachusetts Board of Underwater Archaeological Resources |
| CWA     | Clean Water Act  |
| CZM     | Coastal Zone Management                                    |
| EPA     | U.S. Environmental Protection Agency                       |
| ESA     | Endangered Species Act                                     |
| EFH     | Essential Fish Habitat                                     |
| FNP     | Federal Navigation Project                                 |
| GC      | General Condition  |
| GP      | General Permit   |
| HTL     | High Tide Line   |
| IP      | Individual Permit  |
| LID     | Low impact development                                     |
| MassDEP | Massachusetts Department of Environmental Protection       |
| MA DMF  | Massachusetts Division of Marine Fisheries                 |
| MHC     | Massachusetts Historical Commission                        |
| MHW     | Mean High Water  |
| MLLW    | Mean Lower Low Water                                       |
| MLW     | Mean Low Water   |
| NHPA    | National Historic Preservation Act                         |
| NMFS    | National Marine Fisheries Service                          |
| OHW     | Ordinary High Water Mark                                   |
| PCN     | Preconstruction Notification                               |
| SAS     | Special Aquatic Sites                                      |
| SF      | Square Feet  |
| SV      | Self-Verification  |
| SHPO    | State Historic Preservation Officer                        |
| THPO    | Tribal Historic Preservation Officer                       |
| USFWS   | U.S. Fish and Wildlife Service                             |
| USCG    | U.S. Coast Guard   |
| USFS    | U.S. Forest Service  |
| USGS    | U.S. Geological Service                                    |
| WQC     | Water Quality Certification                                |



## Appendix A: Guidance for NHPA Section 106 Compliance in Massachusetts

### 1. Purpose & Applicability

Section 106 of the National Historic Preservation Act of 1966, as amended (NHPA) (54 U.S.C § 306108), requires Federal agencies to take into account the effects of their undertakings on Historic Properties and afford the Advisory Council on Historic Preservation a reasonable opportunity to comment on such undertakings. Therefore, in order for an activity to be eligible for authorization under the 2023 Massachusetts General Permit, the USACE must consider the effect the activity may have on historic properties. Historic properties may include, but are not limited to, historic districts, archaeological districts, sites, buildings, structures, objects, sacred sites, traditional cultural places, and traditional cultural landscapes that are included in, or eligible for inclusion in, the National Register of Historic Places (NRHP).

This guidance applies to projects that require authorization under Section 404 of the Clean Water Act (33 U.S.C. § 1344) and/or Section 10 of the Rivers and Harbors Act (33 U.S.C. §403) and will assist applicants when evaluating and documenting the presence of historic properties within or near their project site(s). The prospective applicant will evaluate their proposed project using the criteria below to determine if their project has the potential to affect historic properties and if so, whether or not historic properties are present or are likely to be present. All activities authorized under these GPs shall follow the terms outlined in General Condition 14: Historic Properties and General Condition 6: Tribal Rights & Burial Sites. Prospective applicants shall complete their due diligence according to the procedures below for their application to be deemed complete.

### 2. No Potential to Affect Historic Properties

Certain activities do not have the potential to cause effects on historic properties, assuming such historic properties were present, based on the nature of the activity and site-specific conditions. Therefore, these activities **do not** require historic property identification efforts or notification of the SHPO, THPOs, and/or BUAR under Section 106. The USACE has determined the following activities within the stated parameters have no potential to affect historic properties:

| General Permit | Activity Parameters   |
|----------------|---|
| 1              | Temporary buoys, markers and similar structures that are placed during winter events on ice and removed before spring thaw.   |
| 2              | Repair or rehabilitation of structures that are less than 45 years in age. Any temporary structures or fills or work necessary to complete repairs or rehabilitation must not result in any ground disturbance.   |
| 3              | Maintenance and replacement of moorings that are less than 45 years in age.   |
| 6              | Maintenance, repair, replacement, or removal of utility lines, oil or natural gas pipelines, outfall or intake structures, and/or appurtenant features that are less than 45 years in age when all access, staging, and ground disturbance is strictly limited to previously disturbed areas (including any previous ground disturbance). Replacement must be in kind or smaller in size.<br><br>Installation of tide gates on outfall structures that are less than 45 years in age. |
| 7              | Maintenance dredging of previously dredged areas where dredging does not extend beyond the original bottom elevations.  |

|    |   |
|----|---|
|    | Disposal of dredged material at an existing established and USACE-approved confined aquatic disposal cell.<br>Beach nourishment in ongoing existing nourishment areas.  |
| 11 | Fish and wildlife harvesting and attraction devices and activities.   |
| 13 | Cleanup of hazardous and toxic waste materials, including contaminated sediments, that are less than 45 years in age.   |
| 16 | Removal of land-based and water-based renewable energy generation facilities and hydropower projects that are less than 45 years in age.  |
| 18 | Installation of buoys, floats, racks, trays, nets, lines, tubes, containers, and other structures for previously authorized by the USACE and ongoing aquaculture activities.<br>Discharges of dredged or fill material into tidal or non-tidal waters necessary for shellfish seeding, rearing, cultivating, transplanting, and harvesting activities for previously authorized and ongoing aquaculture activities. |
| 20 | Maintenance activities for existing living shorelines <u>excluding</u> maintenance activities that require new ground disturbance such as excavation or re-sloping of the bank/shoreline.   |
| 22 | Reshaping or maintenance of existing drainage ditches less than 45 years in age <u>excluding</u> ditch enlargement.   |
| 23 | Placement of temporary and removable linear transportation and wetland/stream crossings that have no ground disturbance prior to placement, during placement, and during removal (i.e., placed on the surface and subsequently removed within one year of placement).   |
| 24 | Placement of temporary and removable crossings and cofferdams that have no ground disturbance prior to placement, during placement, and during removal (i.e., placed on the surface and subsequently removed within one year of placement).   |
| 25 | Emergency repair of existing structures and/or fills less than 45 years in age.   |

### 3. Historic Property Identification

If the activity does not fit under the criteria above, the following historic property identification efforts must be completed to demonstrate compliance with Section 106 of the NHPA. This includes documenting previously identified and unidentified historic properties in the project area.

a. Previously Identified Historic Properties: The prospective applicant shall document if previously identified historic properties are present on or adjacent to the project site by notifying the Massachusetts Historical Commission (MHC) and the Massachusetts Board of Underwater Archaeological Resources (BUAR), as appropriate, of the proposed project. The MHC and BUAR will check their records for the presence of any previously identified historic properties. The following outlines how prospective applicants should notify the MHC and BUAR.

i. The prospective applicant will notify the SHPO and BUAR to identify any previously recorded cultural resources. Applicants shall mail a completed Project Notification Form<sup>18</sup>, project narrative, location (coordinates), plans, soil maps, and information on known cultural resources to the MHC. The MHC does not accept submissions via email. Applicants shall email or mail this information to the BUAR when the activity is located in lakes, ponds, rivers, and/or navigable waters in MA. Emailed file attachments should be <10MB. Any files >10MB shall be delivered via a file exchange system or the hard copy documents shall be mailed. Preferred contact information is listed below.

ii. **When sending this information, applicants must also document proof of receipt OR proof the information was delivered.** Proof of receipt constitutes a certified mail receipt, read email receipt, or other mail/email/online tracking services that document the information has reached the intended recipient(s). Proof the information was delivered constitutes a certificate of mailing, email delivery receipt, or other mail/email/online services that document the information was sent at a particular time. When using proof of delivery such (e.g., certificate of mailing), applicants should add 5 days to the 30-day notification period so the mail has time to reach its intended recipient. When using proof of receipt, the applicant may begin the 30-day notification period from the date received by the intended recipient.

iii. When mailing or emailing the application materials, applicants should include the following statement: "Please send responses to this notification directly to the USACE via email: [cenae-r-ma@usace.army.mil](mailto:cenae-r-ma@usace.army.mil) or address regular mail responses to: Regulatory Division, U.S. Army Corps of Engineers, New England District, 696 Virginia Road, Concord, Massachusetts 01742-2751." Email responses to the USACE are strongly preferred. The SHPO and BUAR will contact the USACE and cc the applicant(s) within 30 days of receiving the notification if their records indicate that historic properties are located in the project vicinity, and if additional review and/or surveys are recommended to ensure NHPA compliance. If the SHPO and/or BUAR do not respond within 30 days of receiving the notification, it is presumed that no known historic properties are present.

**b. Previously Unidentified Historic Properties:** The prospective applicant shall evaluate the project site and determine the sensitivity for the presence of historic properties if the project site has not been previously surveyed for cultural resources within the last 10 years. If the sensitivity is determined to be moderate to high, an intensive archaeological and/or architectural survey is required to investigate the potential presence of historic properties. The individual conducting this survey must meet the Secretary of the Interior's Standards for Professional Qualifications (48 FR 44738-44739) in the discipline relevant to a particular resource type. For example, archeologists should not document and evaluate buildings or structures and architectural historians should not document and evaluate archaeological sites. The identification and qualifications for those participating in any survey and evaluation of resources should be included with the survey results. The criteria listed below are indicators of low sensitivity for the presence of historic properties for consideration when determining if an archaeological or architectural survey is needed.

Low sensitivity indicators:

- Previous archaeological and/or architectural survey within the last 10 years with negative results.
- In a location created in modern times (i.e., built on fill placed within the last 45 years or within an area excavated within the last 45 years).
- USACE has reviewed the project description and determined that a survey is not warranted based on the proposed activity and its location.

State survey guidance and standards are provided in the September 1995 Historic Properties Survey Manual Guidelines for the Identification of Historical and Archaeological Resources in Massachusetts available. State survey guidance and standards for underwater surveys are provided

<sup>18</sup> <https://www.sec.state.ma.us/mhc/mhcform/formidx.htm>

in the Board of Underwater Archaeological Resources' 2022 Policy Guidance on Archaeological Investigations and Related Survey Standards for the Discovery of Underwater Archaeological Resources. This guidance is available on the NAE Regulatory website: <https://www.nae.usace.army.mil/Missions/Regulatory/State-General-Permits/Massachusetts-General-Permit/>.

Please note, a negative result from MHC and/or BUAR does not necessarily mean no historic properties are present. Often proposed project sites have not been previously subject to a survey, so historic properties which may be present have not been previously recorded.

#### **4. Tribal Coordination**

Prospective applicants shall mail the Project Notification Form, project narrative, location (coordinates), plans with locus map, soil maps, and information on cultural resources to the Wampanoag Tribe of Gay Head (Aquinnah), Mashpee Wampanoag Tribe, Narragansett Indian Tribe, and/or Stockbridge-Munsee Community Band of Mohican Indians with interests in the project location. Preferred tribal contact information, including their respective areas of interest, can be found below. Applicants shall follow the same procedures as identified in Section 3(a)i-iii above when notifying Tribes of the proposed activity. Applicants shall provide the USACE with any responses received from the tribe(s) with their PCN application. If a tribe does not respond within 30 days of receiving the notification, the applicant shall provide USACE with all documentation of tribal outreach with their SV or PCN submission (e.g., emails, letters, phone call log, etc.). If the tribe indicates the presence of a previously unrecorded cultural resource, including a traditional cultural property (TCP) or traditional cultural landscape (TCL), a PCN is required.

#### **5. Effect Determination**

The project may have the potential to affect historic properties and/or tribal resources if 1) notification recipients respond within 30 calendar days of notification with concerns, 2) historic properties eligible for listing, or potentially eligible for listing in the NRHP, are present or 3) tribal resources are known to be present. The USACE may need to further review the project to confirm potential effects to historic properties and/or tribal resources. A PCN is required for any activity that may affect a historic property.

The USACE may determine the project will have 'no effect' on historic properties (i.e., no historic properties affected) when procedures outlined in Section 3 above are followed and no cultural resources are identified. Similarly, if historic properties are identified and will be completely avoided, the USACE may determine 'no effect.'

#### **6. Contact Information:**

##### ***Massachusetts Historical Commission***

The Massachusetts Archives Building  
220 Morrissey Boulevard  
Boston, Massachusetts 02125

No email. Applicants or their representatives must send project information via certified mail and submit the certified mail receipt to the USACE or send via regular mail and submit proof of delivery.

Area of concern: All of Massachusetts.

**Massachusetts Board of Underwater Archaeological Resources (BUAR)**

100 Cambridge Street, Suite 900  
Boston, Massachusetts 02114  
Email: [david.s.robinson@mass.gov](mailto:david.s.robinson@mass.gov)

Applicants or their representatives must send project information via email (***strongly preferred***) or regular mail and provide proof of receipt or proof of delivery.

Area of concern: All waterbodies in Massachusetts.

**Wampanoag Tribe of Gay Head (Aquinnah)**

Bettina Washington  
Tribal Historic Preservation Officer (THPO)  
20 Black Brook Road  
Aquinnah, Massachusetts 02535  
Email: [thpo@wampanoagtribe-nsn.gov](mailto:thpo@wampanoagtribe-nsn.gov)

Applicants or their representative must send project information via email (***preferred***) or regular mail and provide proof of receipt or proof of delivery.

Area of concern: All of Massachusetts.

**Mashpee Wampanoag Tribe**

ATTN: David Weeden  
Tribal Historic Preservation Officer (THPO)  
483 Great Neck Road South  
Mashpee, Massachusetts 02649  
Email: [106review@mwtribe-nsn.gov](mailto:106review@mwtribe-nsn.gov)  
Cc: [David.weeden@mwtribe-nsn.gov](mailto:David.weeden@mwtribe-nsn.gov)

Applicants or their representative must send project information via email (***preferred***) or regular mail and provide proof of receipt or proof of delivery.

Area of concern: All of Massachusetts.

**Narragansett Indian Tribe**

ATTN: John Brown  
Tribal Historic Preservation Officer (THPO)  
Narragansett Indian Longhouse  
4425 South County Trail  
Charlestown, Rhode Island 02813  
Email: [tashtesook@aol.com](mailto:tashtesook@aol.com)

Applicants or their representative must send project information via email (***preferred***) or regular mail and provide proof of receipt or proof of delivery.

Area of concern: Massachusetts east of the Connecticut River.

***Stockbridge-Munsee Community Band of Mohican Indians***

ATTN: Jeff Bendremer  
Tribal Historic Preservation Manager  
Stockbridge-Munsee Community  
Tribal Historic Preservation Extension office  
86 Spring Street  
Williamstown, Massachusetts 01267  
Email: [thpo@mohican-nsn.gov](mailto:thpo@mohican-nsn.gov)

Applicants or their representative must send project information via email (***preferred***) or regular mail and provide proof of receipt or proof of delivery.

Area of concern: West of the Connecticut River and Northfield, Montague, Miller's Falls, Turner's Falls, Sunderland, Amherst, Hadley, South Hadley, Chicopee, Springfield and Longmeadow.

**APPENDIX B PRE-CONSTRUCTION NOTIFICATION**

**U.S. Army Corps of Engineers (USACE), New England District (NAE)  
PRE-CONSTRUCTION NOTIFICATION (PCN)**

**DATA REQUIRED BY THE PRIVACY ACT OF 1974**

**Authority** Rivers and Harbors Act, Section 10, 33 USC 403; Clean Water Act, Section 404, 33 USC 1344; Regulatory Programs of the Corps of Engineers; Final Rule 33 CFR 320-332.

**Principal Purpose** The information provided will be used in evaluating activities under Pre-Construction Notification procedures within New England.

**Routine Uses** This information may be shared with other federal, state, and local government agencies during the application review process. Submission of requested information is voluntary. However, if information is not provided the PCN application cannot be fully evaluated nor can USACE render a permit decision.

**Disclosure**

**Instructions** The applicant must complete ALL required sections of this document before their submission to USACE. The PCN submission to USACE shall include one set of drawings which show the location and character of the proposed activity, statements that address each required field below, and documentation that supports each field (e.g., emails, letters, description/narrative, phone calls, surveys, reports, etc.). Electronic submissions to the following address are strongly preferred: [cenae-r-ma@usace.army.mil](mailto:cenae-r-ma@usace.army.mil). The email subject line shall contain the following: General Permit #, PCN, City/Town, and date submitted. An application that is not completed in full will be returned.

**(ITEMS 1 THRU 4 TO BE FILLED BY USACE)**

|                    |                      |                  |                              |
|--------------------|----------------------|------------------|------------------------------|
| 1. APPLICATION NO. | 2. FIELD OFFICE CODE | 3. DATE RECEIVED | 4. DATE APPLICATION COMPLETE |
|--------------------|----------------------|------------------|------------------------------|

**(ITEMS BELOW TO BE FILLED BY APPLICANT)**

|  |  |   |  |
|--|--|---|--|
| 5. APPLICANT'S NAME<br>First - Middle - Last -<br>Company -<br>E-mail Address -                |  | 8. AUTHORIZED AGENT'S NAME AND TITLE ( <i>agent is not required</i> )<br>First - Middle - Last -<br>Company -<br>E-mail Address - |  |
| 6. APPLICANT'S ADDRESS:<br>Address-<br>City - State - Zip - Country -                          |  | 9. AGENT'S ADDRESS:<br>Address-<br>City - State - Zip - Country -   |  |
| 7. APPLICANT'S PHONE NOs. with AREA CODE<br>a. Residence    b. Business    c. Fax    d. Mobile |  | 10. AGENT'S PHONE NOs. with AREA CODE<br>a. Residence    b. Business    c. Fax    d. Mobile                                       |  |

**STATEMENT OF AUTHORIZATION**

11. I hereby authorize, \_\_\_\_\_ to act on my behalf as my agent in the processing of this general permit PCN application and to furnish, upon request, supplemental information in support of this general permit PCN application.

\_\_\_\_\_  
SIGNATURE OF APPLICANT

\_\_\_\_\_  
DATE

**NAME, LOCATION, AND DESCRIPTION OF PROJECT OR ACTIVITY**

|   |  |
|---|--|
| 12. PROJECT NAME or TITLE ( <i>see instructions</i> )   |  |
| 13. NAME OF WATERBODY, IF KNOWN ( <i>if applicable</i> )  | 14. PROPOSED ACTIVITY STREET ADDRESS ( <i>if applicable</i> )<br><br>City: State: Zip: |
| 15. LOCATION OF PROPOSED ACTIVITY ( <i>see instructions</i> )<br><br>Latitude: °N Longitude: °W |  |



16. OTHER LOCATION DESCRIPTIONS, IF KNOWN (*see instructions*)

State Tax Parcel ID:

Municipality:

Section:

Township:

Range:

17. DIRECTIONS TO THE SITE.

18. IDENTIFY THE SPECIFIC GENERAL PERMIT(S) YOU PROPOSE TO USE:

19. DESCRIPTION OF PROPOSED GENERAL PERMIT ACTIVITY (*see instructions*)

20. DESCRIPTION OF PROPOSED MITIGATION MEASURES (*see instructions*)

21. PURPOSE OF GENERAL PERMIT ACTIVITY (*Describe the reason or purpose of the project, see instructions*)

22. Quantity of Wetlands, Streams, or Other Types of Waters Directly Affected by Proposed General Permit Activity (*see instructions*)

| Area (square feet) | Length (linear feet) | Volume (cubic yards) | Duration | Purpose |
|--------------------|----------------------|----------------------|----------|---------|
|                    |                      |                      |          |         |
|                    |                      |                      |          |         |
|                    |                      |                      |          |         |
|                    |                      |                      |          |         |
|                    |                      |                      |          |         |

**Each PCN must include a delineation of wetlands, other special aquatic sites, and other waters, such as lakes and ponds, and perennial, intermittent, and ephemeral streams, on the project site.**

23. List any other GP(s), regional general permit(s), or individual permit(s) used or intended to be used to authorize any part of the proposed project on any related activity (*see instructions*)

24. If the proposed activity will result in the loss of aquatic resources that exceed those identified in the New England District Compensatory Mitigation Thresholds, explain how the compensatory mitigation requirement will be satisfied. (*see instructions*)

25. Is Any Portion of the General Permit Activity Already Complete?  Yes  No If Yes, describe the completed work:

26. List the name(s) of any species listed as endangered or threatened under the Endangered Species Act that might be affected by the proposed GP activity or utilize the designated critical habitat that might be affected by the proposed GP activity. (*see instructions*)

27. List any historic properties that have the potential to be affected by the proposed GP activity or include a vicinity map indicating the location of the historic property or properties. Attach relevant project information, along with any responses received from project notifications to this submittal. (*see instructions*)

28. For a proposed GP activity that will occur in a component of the National Wild and Scenic River System, or in a river officially designated by Congress as a "study river" for possible inclusion in the system while the river is in an official study status, identify the Wild and Scenic River or the "study river":

29. If the proposed GP activity also requires permission from the USACE pursuant to 33 U.S.C. 408 because it will alter or temporarily or permanently occupy or use a U.S. Army Corps of Engineers federally authorized civil works project, have you submitted a written request for section 408 permission from the USACE district having jurisdiction over that project?  Yes  No  
 If "yes", please provide the date your request was submitted to the USACE District:

30. Does the activity require a 401 Water Quality Certification (WQC)? If so, specify the type of 401 WQC that is required (general or individual). In cases where an individual 401 WQC is required, provide the date the 401 WQC certification request was submitted to the certifying authority and their contact information.

31. If the terms of the GP(s) you want to use require additional information to be included in the PCN (i.e. sampling and analysis plan), please include that information in this space or provide it on an additional sheet of paper marked Block 30. (*see instructions*)

32. I certify that the information in this pre-construction notification is complete and accurate. I further certify that I possess the authority to undertake the work described herein or am acting as the duly authorized agent of the applicant.

|                        |      |                    |      |
|------------------------|------|--------------------|------|
| SIGNATURE OF APPLICANT | DATE | SIGNATURE OF AGENT | DATE |
|------------------------|------|--------------------|------|

The Pre-Construction Notification must be signed by the person who desires to undertake the proposed activity (applicant) and, if the statement in block 11 has been filled out and signed, the authorized agent.

18 U.S.C. Section 1001 provides that: Whoever, in any manner within the jurisdiction of any department or agency of the United States knowingly and willfully falsifies, conceals, or covers up any trick, scheme, or disguises a material fact or makes any false, fictitious or fraudulent statements or representations or makes or uses any false writing or document knowing same to contain any false, fictitious or fraudulent statements or entry, shall be fined not more than \$10,000 or imprisoned not more than five years or both.

**Instructions for Preparing a  
Department of the Army  
General Permit (GP) Pre-Construction Notification (PCN)**

**Blocks 1 through 4.** To be completed by the U.S. Army Corps of Engineers.

**Block 5. Applicant' Name.** Enter the name and the e-mail address of the responsible party or parties. If the responsible party is an agency, company, corporation, or other organization, indicate the name of the organization and responsible officer and title. If more than one party is associated with the PCN, please attach a sheet of paper with the necessary information marked Block 5.

**Block 6. Address of Applicant.** Please provide the full address of the party or parties responsible for the PCN. If more space is needed, attach an extra sheet of paper marked Block 6.

**Block 7. Applicant Telephone Number(s).** Please provide the telephone number where you can usually be reached during normal business hours.

**Blocks 8 through 11.** To be completed, if you choose to have an agent.

**Block 8. Authorized Agent's Name and Title.** Indicate name of individual or agency, designated by you, to represent you in this process. An agent can be an attorney, builder, contractor, engineer, consultant, or any other person or organization. Note: An agent is not required.

**Blocks 9 and 10. Agent's Address and Telephone Number.** Please provide the complete mailing address of the agent, along with the telephone number where they can be reached during normal business hours.

**Block 11. Statement of Authorization.** To be completed by the applicant, if an agent is to be employed.

**Block 12. Proposed General Permit Activity Name or Title.** Please provide a name identifying the proposed GP activity, e.g., Windward Marina, Rolling Hills Subdivision, or Smith Commercial Center.

**Block 13. Name of Waterbody.** Please provide the name (if it has a name) of any stream, lake, marsh, or other waterway to be directly impacted by the GP activity. If it is a minor (no name) stream, identify the waterbody the minor stream enters.

**Block 14. Proposed Activity Street Address.** If the proposed GP activity is located at a site having a street address (not a box number), enter it in Block 14.

**Block 15. Location of Proposed Activity.** Enter the latitude and longitude of where the proposed GP activity is located. Indicate whether the project location provided is the center of the project or whether the project location is provided as the latitude and longitude for each of the "corners" of the project area requiring evaluation. If there are multiple sites, please list the latitude and longitude of each site (center or corners) on a separate sheet of paper and mark as Block 15.

**Block 16. Other Location Descriptions.** If available, provide the Tax Parcel Identification number of the site, Section, Township, and Range of the site (if known), and / or local Municipality where the site is located.

**Block 17. Directions to the Site.** Provide directions to the site from a known location or landmark. Include highway and street numbers as well as names. Also provide distances from known locations and any other information that would assist in locating the site. You may also provide a description of the location of the proposed GP activity, such as lot numbers, tract numbers, or you may choose to locate the proposed GP activity site from a known point (such as the right descending bank of Smith Creek, one mile downstream from the Highway 14 bridge). If a large river or stream, include the river mile of the proposed GP activity site if known. If there are multiple locations, please indicate directions to each location on a separate sheet of paper and mark as Block 17.

**Block 18. Identify the Specific General Permit(s) You Propose to Use.** List the number(s) of the General Permit(s) you want to use to authorize the proposed activity (e.g., GP 4).

**Block 19. Description of the Proposed General Permit Activity.** Describe the proposed GP activity, including the direct and indirect adverse environmental effects of the proposed activity. The description of the proposed activity should be sufficiently detailed for USACE to determine that the adverse environmental effects of the activity will be no more than minimal. Identify the materials to be used in construction, as well as the methods by which the work is to be done.

Provide drawings to show that the proposed GP activity complies with the terms of the applicable GP(s). Drawings should contain sufficient detail to provide an illustrative description of the proposed GP activity, but do not need to be detailed engineering plans. The written descriptions and illustrations are an important part of the application. Please describe, in detail, what you wish to do. If more space is needed, attach an extra sheet of paper marked Block 19.

**Block 20: Description of Proposed Mitigation Measures.** Describe any proposed mitigation measures intended to reduce the adverse environmental effects caused by the proposed GP activity. The description of any proposed mitigation measures should be sufficiently detailed for USACE to determine how the measures would avoid and minimize adverse environmental effects. If adverse effects exceed the New England District compensatory mitigation thresholds, you must document how compensatory mitigation would be satisfied in Block 24.

**Block 21. Purpose of General Permit Activity.** Describe the purpose and need for the proposed GP activity. What will it be used for and why? Also include a brief description of any related activities associated with the proposed project. Provide the approximate dates you plan to begin and complete all work.

**Block 22. Quantity of Wetlands, Streams, or Other Types of Waters Directly Affected by the Proposed General Permit Activity.** For discharges of dredged or fill material into Waters of the U.S., provide the amount of wetlands, streams, or other types of waters filled, flooded, excavated, or drained by the proposed GP activity. For structures or work in Navigable Waters of the U.S. subject to Section 10 of the Rivers and Harbors Act of 1899, provide the amount of navigable waters filled, dredged, occupied by one or more structures (e.g., aids to navigation, mooring buoys) by the proposed GP activity. The area of impact includes the structures or fills with direct or indirect effects to waters of the U.S. The length of impact includes the length of a stream, including its banks, that are directly affected by the structures or fills. The duration of impact should be identified as temporary (xx days) or permanent. The impact purpose should briefly describe what structure or fill is responsible for the impact.

**Block 23. Identify Any Other General Permit(s), Regional General Permit(s), or Individual Permit(s) Used to Authorize Any Part of Proposed Activity or Any Related Activity.** List any other GP(s) or individual permit(s) used or intended to be used to authorize any part of the proposed project or any related activity. For linear projects, list other separate and distant crossings of waters and wetlands authorized by these GPs that do not require PCNs. If more space is needed, attach an extra sheet of paper marked Block 23.

**Block 24. Compensatory Mitigation Statement for Losses Greater Than the New England District Compensatory Mitigation Thresholds.** New England District requires compensatory mitigation at a minimum one for one replacement ratio or greater for all aquatic resource losses that require a PCN and exceed the New England District Compensatory Mitigation Thresholds, unless USACE determines in writing that either some other form of mitigation is more environmentally appropriate or the adverse environmental effects of the proposed GP activity are no more than minimal without compensatory mitigation, and provides an activity specific waiver of this requirement. Describe the proposed compensatory mitigation for wetland losses greater than the New England District Compensatory Mitigation Thresholds or provide an explanation of why USACE should not require wetland compensatory mitigation for the proposed GP activity. If more space is needed, attach an extra sheet of paper marked Block 24.

**Block 25. Is Any Portion of the General Permit Activity Already Complete?** Describe any work that has already been completed for the GP activity.

**Block 26. List the Name(s) of Any Species Listed As Endangered or Threatened under the Endangered Species Act that Might be Affected by the General Permit Activity.** If you are not a federal agency, and if any listed species or designated critical habitat might be affected or is in the vicinity of the proposed GP activity, or if the proposed GP activity is located in designated critical habitat, list the name(s) of those endangered or threatened species that might be affected by the proposed GP activity or utilize the designated critical habitat that might be affected by the proposed GP activity. If you are a Federal agency, and the proposed GP activity requires a PCN, you must provide documentation demonstrating compliance with Section 7 of the Endangered Species Act.

**Block 27. List Any Historic Properties that Have the Potential to be Affected by the General Permit Activity.** If you are not a federal agency, and if any historic properties have the potential to be affected by the proposed GP activity, list the name(s) of those historic properties that have the potential to be affected by the proposed GP activity. Provide all relevant documentation about these historic properties in the PCN submittal. If you are a Federal agency, and the proposed GP activity requires a PCN, you must provide documentation demonstrating compliance with Section 106 of the National Historic Preservation Act.

**Block 28. List the Wild and Scenic River or Congressionally Designated Study River if the General Permit Activity Would Occur in such a River.** If the proposed GP activity will occur in a river in the National Wild and Scenic River System or in a river officially designated by Congress as a "study river" under the Wild and Scenic Rivers Act, provide the name of the river. For a list of Wild and Scenic Rivers and study rivers, please visit <http://www.rivers.gov/>

**Block 29. General Permit Activities that also Require Permission from the USACE Under 33 U.S.C. 408.** If the proposed GP activity also requires permission from the USACE under 33 U.S.C. 408 because it will temporarily or permanently alter, occupy, or use a USACE federal authorized civil works project, indicate whether you have submitted a written request for section 408 permission from the USACE district having jurisdiction over that project.

**Block 30. 401 Water Quality Certification.** As described above, specify if the activity requires a 401 WQC from the certifying authority.

**Block 31. Other Information Required For General Permit Pre Construction Notifications.** The terms of some of the General Permits include additional information requirements for preconstruction notifications:

- \* Maintenance – information regarding the original design capacities and configurations of the outfalls, intakes, small impoundments, and canals.
- \* Temporary Construction, Access, and Dewatering – a restoration plan showing how all temporary fills and structures will be removed and the area restored to pre-project conditions.
- \* Repair of Uplands Damaged by Discrete Events – documentation, such as a recent topographic survey or photographs, to justify the extent of the proposed restoration.
- \* Commercial Shellfish Aquaculture Activities – (1) a map showing the boundaries of the project area, with latitude and longitude coordinates for each corner of the project area; (2) the name(s) of the species that will be cultivated during the period this GP is in effect; (3) whether canopy predator nets will be used; (4) whether suspended cultivation techniques will be used; and (5) general water depths in the project area (a detailed survey is not required). Dredging – (1) a proposed sampling and analysis plan shall be provided to USACE for approval prior to its execution. Pre-application meetings are encouraged.
- \* Beach Nourishment – sediment grain size should be determined for the length of the beach where nourishment is proposed. The frequency and locations of sediment sampling shall be sufficient to identify the sediment composition of the beach profile. This data shall be consolidated to generate a sediment gradation curve for each sampled transect. Each sampled transect should also be identified on the project plans (drawings).

If more space is needed, attach an extra sheet of paper marked Box 31.

**Block 32. Signature of Applicant or Agent.** The PCN must be signed by the person proposing to undertake the GP activity, and if applicable, the authorized party (agent) that prepared the PCN. The signature of the person proposing to undertake the GP activity shall be an affirmation that the party submitting the PCN possesses the requisite property rights to undertake the GP activity (including compliance with special conditions, mitigation, etc.).

#### **DELINEATION OF WETLANDS, OTHER SPECIAL AQUATIC SITES, AND OTHER WATERS**

Each PCN must include a delineation of wetlands, other special aquatic sites, and other waters, such as lakes and ponds, and perennial, intermittent, and ephemeral streams, on the project site. Wetland delineations must be prepared in accordance with the current wetland delineation manual and regional supplement published by the USACE. The permittee may ask the USACE to delineate the special aquatic sites and other waters on the project site, but there may be a delay if the USACE does the delineation, especially if the project site is large or contains many wetlands, other special aquatic sites, and other waters. The 60-day PCN review period will not start until a delineation has been completed.

#### **DRAWINGS AND ILLUSTRATIONS**

##### **General Information.**

Three types of illustrations are needed to properly depict the work to be undertaken. These illustrations or drawings are identified as a Vicinity Map, a Plan View or a Typical Cross Section Map. Identify each illustration with a figure or attachment number. For linear projects (e.g. roads, subsurface utility lines, etc.) gradient drawings should also be included. Please submit one copy of all drawings on 8½ x 11 inch plain white paper (electronic submissions preferred). Use the fewest number of sheets necessary for your drawings or illustrations. Each illustration should identify the project, the applicant, and the type of illustration (vicinity map, plan view, or cross section). While illustrations need not be professional (many small, private project illustrations are prepared by hand), they should be clear, accurate, and contain all necessary information.

#### **ADDITIONAL INFORMATION AND REQUIREMENTS**

For proposed GP activities that involve discharges into waters of the United States, water quality certification from the State, Tribe, or EPA must be obtained or waived. Some States, Tribes, or EPA have issued water quality certification for one or more GPs. Please check the New England District website to see if water quality certification has already been issued for the GP(s) you wish to use. For proposed GP activities in coastal states, state Coastal Zone Management Act consistency concurrence must be obtained, or a presumption of concurrence must occur. Some States have issued Coastal Zone Management Act consistency concurrences for one or more GPs. Please check the New England District website to see if Coastal Zone Management Act consistency concurrence has already been issued for the GP(s) you wish to use.

**APPENDIX C SELF-VERIFICATION NOTIFICATION**

**U.S. Army Corps of Engineers (USACE)  
SELF-VERIFICATION NOTIFICATION (SVN)**

**DATA REQUIRED BY THE PRIVACY ACT OF 1974**

**Authority** Rivers and Harbors Act, Section 10, 33 USC 403; Clean Water Act, Section 404, 33 USC 1344; Regulatory Programs of the Corps of Engineers; Final Rule 33 CFR 320-332.

**Principal Purpose** This information will be used in evaluating activities under Self-Verification procedures within Massachusetts.

**Routine Uses** Routine uses will include: (1) Documenting compliance with the terms and conditions of the General Permit (GP) for activities that may require authorization pursuant to one or more of USACE's Regulatory authorities. (2) Records may be referred to other Federal, State, and local agencies for evaluation and enforcement purposes.

**Disclosure** Failure to fully comply and abide by the GP terms and conditions prior to commencing work and after completion project may result in formal enforcement action, up to and including monetary penalties and/or legal action, pursuant to 33 CFR Part 326.

**Instructions** The permittee must complete ALL required sections of this document before commencing USACE-regulated activities. A copy of this completed SVN must be kept on site during construction and be made available for review by USACE and other Federal, State, & Local regulatory authorities at any time. Within 30 days of initiating project construction, the permittee shall submit the completed SVN to USACE. The SVN shall be submitted to USACE as **ONE signed document** that includes project plans and documentation that supports each field (e.g., emails, letters, description, phone calls, surveys). Electronic submissions to the following address are strongly preferred: [cenae-r-ma-sv@usace.army.mil](mailto:cenae-r-ma-sv@usace.army.mil). The email subject line shall contain the following: GP #, SVN, City/Town, and date submitted.

**(ITEMS 1 THRU 3 TO BE FILLED BY USACE)**

|                    |                      |                  |
|--------------------|----------------------|------------------|
| 1. APPLICATION NO. | 2. FIELD OFFICE CODE | 3. DATE RECEIVED |
|--------------------|----------------------|------------------|

**APPLICANT AND AGENT INFORMATION**

|   |   |
|---|---|
| <b>4. APPLICANT'S NAME</b><br>First -                      Middle -                      Last -<br>Company -<br>E-mail Address -            | <b>7. AGENT'S ADDRESS:</b><br>First -                      Middle -                      Last -<br>Company -<br>E-mail Address -        |
| <b>5. APPLICANT'S ADDRESS:</b><br>Address-<br>City -                      State -                      Zip -                      Country - | <b>8. AGENT'S ADDRESS:</b><br>Address-<br>City -                      State -                      Zip -                      Country - |
| <b>6. APPLICANT'S PHONE NOs. w/AREA CODE</b><br>a. Residence                      b. Business                      c. Fax                   | <b>9. AGENTS PHONE NOs. w/AREA CODE</b><br>a. Residence                      b. Business                      c. Fax                    |

**NAME, LOCATION, AND DESCRIPTION OF PROJECT SITE**

|   |   |
|---|---|
| 10. PROJECT NAME OR TITLE   |   |
| 11. FILE NUMBER(S) OF PREVIOUS USACE ACTIONS ON THE SITE (if applicable)                        | 12. NAME OF WATERBODY   |
| 13. PROJECT COORDINATES (in decimal degrees)<br>Latitude: °N                      Longitude: °W | 14. PROJECT STREET ADDRESS (if applicable)<br>Address<br>City -                      State -                      Zip - |

**ACTIVITY TYPE, PROJECT IMPACTS, AVOIDANCE & MINIMIZATION**

**15. GENERAL PERMIT ACTIVITIES (CHECK ALL THAT APPLY)**

|         |          |          |          |          |
|---------|----------|----------|----------|----------|
| 1 _____ | 6 _____  | 11 _____ | 16 _____ | 21 _____ |
| 2 _____ | 7 _____  | 12 _____ | 17 _____ | 22 _____ |
| 3 _____ | 8 _____  | 13 _____ | 18 _____ | 23 _____ |
| 4 _____ | 9 _____  | 14 _____ | 19 _____ | 24 _____ |
| 5 _____ | 10 _____ | 15 _____ | 20 _____ | 25 _____ |

**16. SUMMARY OF PROJECT IMPACTS (see instructions)**

| Area (square feet) | Length (linear feet) | Volume (cubic yards) | Duration |
|--------------------|----------------------|----------------------|----------|
|                    |                      |                      |          |
|                    |                      |                      |          |
|                    |                      |                      |          |
|                    |                      |                      |          |
|                    |                      |                      |          |

17. PROJECT PLANS (BY CHECKING THE BOXES BELOW, YOU CERTIFY THESE ITEMS ARE COMPLETE) (*see instructions*)

- a. Plans shall at least contain the following: Vicinity Map, Plan View, and Typical Cross Section View of the proposed activity.
- b. All direct, indirect and secondary impacts from USACE regulated activities are shown on the project plans.
- c. The size of the impact area for each activity (acre, square feet, linear feet) are shown on the project plans.
- d. For discharges of fill material (§404), the volume of fill material is identified on the project plans.
- e. The duration of each impact, permanent or temporary (X days), is identified on the project plans.
- f. Do activities with permanent impacts result in the loss of waters? If so, this is identified on the project plans.
- g. All aquatic resources in the vicinity of the USACE regulated activities are delineated on the project plans.

18. AVOIDANCE & MINIMIZATION (BY CHECKING THE BOXES BELOW, YOU CERTIFY THESE CRITERIA ARE MET) (*see instructions*)

- a. The project has been designed to avoid and minimize impacts to aquatic resources.
- b. The footprint of activities in waters of the U.S. has been reduced to only what is necessary to achieve the overall project purpose.
- c. All practicable measures have been taken to avoid and minimize impacts to aquatic resources through construction techniques and site access (e.g., Best Management Practices, Time of Year Restrictions).
- d. All temporary impacts from USACE regulated activities will be restored upon completion of construction and the project area will be returned to pre-construction contours and conditions.

**COMPLIANCE WITH FEDERAL REGULATIONS & SUPPLEMENTAL INFORMATION**

19. DUE DILIGENCE (*see instructions*)

Complete the entries below to document compliance with the following Federal requirements. Construction may NOT begin if a PCN is/may be required, and you must contact USACE to determine permitting requirements. Documentation that demonstrates how the activity complies with each field below shall be submitted to the USACE as noted in the instructions block. See each General Condition (GC) in the GP for how to comply with each requirement.

- a. State Historic Preservation Officer
- b. Massachusetts BUAR
- c. Tribal Historic Preservation Officers
- d. Endangered Species Act - NOAA
- e. Endangered Species Act - USFWS
- f. Northern Long Eared Bat (ESA)
- g. Essential Fish Habitat
- h. Wild & Scenic Rivers
- i. 401 Water Quality Certification 401
 

|  |                          |             |             |
|--|--------------------------|-------------|-------------|
|  | 401 WQC/OOC File Number: | OOC issued: | 401 issued: |
|--|--------------------------|-------------|-------------|
- j. Section 408 Permission
- k. Coastal Zone
- l. Construction Mats
- m. Time of Year Restrictions
- n. Vernal Pools
- o. Sediment & Erosion Controls
- p. Stream/Wetland Crossings

20. AQUACULTURE ACTIVITIES - GP 18 (*see instructions*)

- a. If required, an Aquaculture Certification from the Massachusetts Division of Marine Fisheries was obtained prior to commencing work.
- b. Coordination with the U.S. Coast Guard pursuant to Private Aids to Navigation has occurred prior to commencing work.
- c. If required, a MEPA Certificate was obtained from the Massachusetts Environmental Protection Agency prior to commencing work.
- d. The prospective permittee contacted local authorities (e.g. harbormaster, select board, shellfish constable) for authorization of their facility prior to commencing work.

21. ADDITIONAL INFORMATION/ATTACHMENTS (*see instructions*)

- a. The project plans are enclosed in this SVN submittal (*see block 17*).
- b. The activity \_\_\_\_\_ funded through the Bipartisan Infrastructure Bill (also known as the Infrastructure Investment and Jobs Act).
- c. All required state, local and federal approvals were acquired prior to starting construction in USACE jurisdiction.
- d. After construction of the activity is completed, a complete Certificate of Compliance will be submitted to USACE.

22. IS THERE ANOTHER LEAD FEDERAL AGENCY:

YES      NO



23. STATEMENT OF AUTHORIZATION *(see instructions)*

I certify that I possess the authority to undertake the work described herein or am acting as the duly authorized agent of the applicant.

SIGNATURE OF APPLICANT

DATE

SIGNATURE OF AGENT

DATE

24. SIGNATURES *(see instructions)*

I hereby certify that the information in this Self-Verification Notification is complete and accurate. As the applicant or their duly authorized agent, I certify the activity was completed in accordance with the terms and conditions of the GP. This includes all applicable terms, general conditions, and activity-specific GP criteria. I agree to allow the duly authorized representatives of the Corps of Engineers Regulatory Program and other regulatory or advisory agencies to enter upon the premises of the project site at reasonable times to evaluate inspect and photograph site conditions. This consent to enter the property is superior to, takes precedence over, and waives any communication to the contrary. For example, if the property is posted as "no trespassing" this consent specifically supersedes and waives that prohibition and grants permission to enter the property despite such posting.

SIGNATURE OF APPLICANT

DATE

SIGNATURE OF AGENT

DATE

18 U.S.C. Section 1001 provides that: Whoever, in any manner within the jurisdiction of any department or agency of the United States knowingly and willfully falsifies, conceals, or covers up any trick, scheme, or disguises a material fact or makes any false, fictitious or fraudulent statements or representations or makes or uses any false writing or document knowing same to contain any false, fictitious or fraudulent statements or entry, shall be fined not more than \$10,000 or imprisoned not more than five years or both.

**Instructions for Preparing a  
Department of the Army  
General Permit (GP) Self-Verification**

**Blocks 1 through 3.** To be completed by the Corps of Engineers.

**Block 4. Applicant' Name.** Enter the name and the e-mail address of the responsible party or parties. If the responsible party is an agency, company, corporation, or other organization, indicate the name of the organization and responsible officer and title. If more than one party is associated with the self-verification, please attach a sheet of paper with the necessary information marked Block 4.

**Block 5. Address of Applicant.** Please provide the full address of the party or parties responsible for the self-verification. If more space is needed, attach an extra sheet of paper marked Block 5.

**Block 6. Applicant Telephone Number(s).** Please provide the telephone number where you can usually be reached during normal business hours.

**Blocks 7 through 9.** To be completed, if you choose to have an agent.

**Block 7. Authorized Agent's Name and Title.** Indicate name of individual or agency, designated by you, to represent you in this process. An agent can be an attorney, builder, contractor, engineer, consultant, or any other person or organization. Note: An agent is not required.

**Blocks 8 and 9. Agent's Address and Telephone Number.** Please provide the complete mailing address of the agent, along with the telephone number where they can be reached during normal business hours.

**Block 10. Proposed General Permit Activity Name or Title.** Please provide a name identifying the proposed GP activity, e.g., Windward Marina, Rolling Hills Subdivision, or Smith Commercial Center.

**Block 11. File Number(s) of Previous USACE Actions on the Site** Please provide any known USACE file number. If the activity does not have a known USACE file number, you may state N/A.

**Block 12. Name of Waterbody.** Please provide the name (if it has a name) of any stream, lake, marsh, or other waterway to be directly impacted by the GP activity. If it is a minor (no name) stream, identify the waterbody the minor stream enters.

**Block 13. Proposed Activity Coordinates.** Please enter the latitude and longitude of where the proposed GP activity is located. Indicate whether the project location provided is the center of the project or whether the project location is provided as the latitude and longitude for each of the "corners" of the project area. If there are multiple sites, please list the latitude and longitude of each site (center or corners) on a separate sheet of paper and mark as Block 13.

**Block 14. Proposed Activity Street Address.** If the proposed activity is located at a site having a street address (not a box number), enter it in Block 14.

**Block 15. General Permit Activity Type.** Please select all GP activity types that apply to the proposed activity. A list of GP activity types can be found in Section III of the GP.

**Block 16. Summary of Project Impacts.** Please provide ALL proposed impacts, both temporary and permanent in duration, that are located in Waters of the United States. The area of impact shall be provided in square feet (SF). When applicable, impacts that result in conversion of stream bank or shoreline must also be identified in linear feet (LF). Dredging or the discharge of dredged or fill material shall also include the volume, cubic yards (CY), of material removed from or placed into Waters of the U.S. If more entries are required, please attach a table matching the desired format in Block 16.

**Block 17. Project Plans.** Please verify that items a-g are included in the project plans. Three types of illustrations are necessary to properly depict the proposed work. These illustrations or drawings are identified as a Vicinity Map, a Plan View (Aerial view) and a Cross Section Map. For linear projects (e.g. roads, subsurface utility lines, etc.) gradient drawings (longitudinal profile) should also be included. Plans must accurately depict the existing conditions and all aspects of the proposed activity located in waters of the U.S. Please submit one copy of all drawings formatted to print on 8½ x 11 inch or 11 x 17 inch plain white paper. Use the fewest number of sheets necessary for your drawings or illustrations. Each illustration should identify the project, the applicant, and the type of illustration (vicinity map, plan view, or cross section). While illustrations need not be certified engineering sheets; they should be clear, accurate, contain all necessary information, and depict all proposed work. Each submission must also include a delineation of wetlands, other special aquatic sites, and other waters, such as lakes and ponds, and perennial, intermittent, and ephemeral streams, on the project site. Wetland delineations must be prepared in accordance with the current wetland delineation manual and regional supplement published by USACE.

**Block 18. Avoidance & Minimization.** Please verify that items a-d have been implemented for the proposed activity.

**Block 19. Due Diligence.** Please complete all the fields and submit documentation to USACE to demonstrate compliance with the above requirements. This Documentation may include emails, letters, meeting notes, phone call log, project narrative, project plans, a species list from the NOAA Section 7 Mapper, a completed copy of the IPAC determination keys, etc. Documentation should be limited to what is necessary to demonstrate how the proposed activity meets each requirement. Refer to the MA GP, Appendix A, for specific guidance on the identification of previously identified historic properties and previously unidentified historic properties. Endangered Species: \*The applicant must be designated as the non-federal representative for the purposes of Section 7 consultation to select the Rangewide D-Key options. Otherwise, the applicant shall select the following option when IPAC indicates the NLEB is present: "The activity IS located within the NLEB Species Range (PCN Required)."

**Block 20. Aquaculture Activities.** Please verify that items a-d have been obtained or completed prior to commencing work in waters of the U.S.

**Block 21. Additional Information/Attachments.** Please verify that items a-d have been completed prior to commencing work in waters of the U.S.

**Block 22. Lead Federal Agency.** Please identify if there is another lead federal agency involved with the proposed activity. Enter the lead federal agency name (e.g., the Federal Emergency Management Agency, FEMA) and the agency's designated person of contact for the activity.

**Block 23. Statement of Authorization.** The applicant shall sign this section for all activities. If an agent is to be employed, the agent shall sign this section.

**Block 24. Signatures.** The SVN must be signed by the person proposing to undertake the GP activity, and if applicable, the authorized party (agent) that prepared the SVN. The signature of the person proposing to undertake the GP activity shall be an affirmation that the party submitting the SVN possesses the requisite property rights to undertake the GP activity.



**US Army Corps  
of Engineers®**  
New England District

## **APPENDIX D: PCN APPLICATION CHECKLIST**

The following information shall be submitted for all PCNs for USACE to properly evaluate your application. Some applications may require more information and this checklist is offered as a tool to assist applicants with submitting a complete application.

### **SECTION 1: GENERAL APPLICATION INFORMATION**

1.  Complete the Pre-Construction Notification document (Appendix B).
2.  Specify which local/state/federal authorizations are required for the project and if any have been obtained or applied for at the time of USACE application submittal.
3.  Identify all funding sources the project will receive or has received to date. Provide any relevant information in the application submission.
4.  Is this part of a larger project that is being implemented in phases? If so, describe the project schedule and how each phase will be implemented.
5.  Describe the existing conditions on the site and the general land use in the vicinity of the project at the time application submittal.
6.  Provide any historic information available that you may have of project area, e.g., existing USACE permit numbers, the names under which the permits were obtained if the permit numbers are unknown, construction dates and proof of prior existence (aerials, photos, town hall records, affidavits, state or local permits, etc.) to verify that the project predates regulation and is "vested".<sup>19</sup>
7.  The anticipated start and end dates for construction.

### **SECTION 2: WETLAND DELINEATION**

8.  Data used to support aquatic resource boundary determinations (delineation forms, delineation map(s) that show the locations of each aquatic resource in the project area, aerial and ground photographs, LIDAR imagery, national wetland inventory maps, soil maps, national hydrography dataset maps, floodplain maps, historical imagery, etc.).
9.  Photographs of the wetland(s) and/or waterway(s) where impacts are proposed. Photos at low tide are preferred for work in tidal waters.
10.  Indicate the relationship of the project area to waters of the U.S., i.e., adjacent wetlands, tidal influence or hydraulic connectivity through culverts, or other conveyances, etc.
11.  At minimum the delineation map/figure should include the following:
  - a. Contour lines showing topography.
  - b. North arrow.
  - c. Bar and text scale.
  - d. Legend.
  - e. Drawn project boundary.
  - f. High tide line, mean high water, mean low water, ordinary high water mark, and/or wetland boundaries.
  - g. Captions with a unique name for each aquatic resource and the area or length of the aquatic resource within the project area.

<sup>19</sup> Vested is exempt (someone or something) from a new law or regulation.

- h. Appropriate landmarks and features (e.g., culverts, special aquatic sites, etc.).
- i. Points showing the paired upland and wetland delineation locations for tidal and non-tidal wetlands only.

### **SECTION 3: AVOIDANCE & MINIMIZATION**

- 12.  Describe specific measures taken to avoid impacts to aquatic resources or describe why aquatic resources could not be avoided while achieving the project purpose and need.
- 13.  For impacts to aquatic resources that could not be avoided, describe specific considerations/ measures taken to minimize the area of proposed impacts to aquatic resources in designing the project.
- 14.  Describe specific measures taken to avoid and minimize the proposed direct, indirect, and secondary impacts to aquatic resources and their functions through construction techniques and timing.
- 15.  If applicable, provide a restoration plan that describes how all temporary fills and structures will be removed and the area restored to pre-impact conditions (see GC 22).
- 16.  If applicable, provide an Invasive Species Control Plan (see GC 29). For sample control plans, see [www.nae.usace.army.mil/missions/regulatory/invasive-species](http://www.nae.usace.army.mil/missions/regulatory/invasive-species).
- 17.  If applicable, describe how the proposed wetland/waterbody crossing is compliant with GC 31, Stream Work and Crossings, and Wetland Crossings.

### **SECTION 4A: PROJECT IMPACTS**

- 18.  Describe the overall project and the activities located in Waters of the U.S. (WOTUS) that you are seeking authorization for.
- 19.  Identify the following for project impacts in WOTUS:
  - a.  Direct, indirect, secondary impacts<sup>20</sup> within WOTUS.
  - b.  The size of each impact (square feet or acres, or linear feet).
  - c.  For discharges of fill material (§404), specify the volume of fill material to be discharged (cubic yards).
  - d.  The impact duration from each activity, permanent or temporary (X days).

### **SECTION 4B: PROJECT PLANS**

- 20.  Submit project plans that depict all impacts in WOTUS. On the project plans, applicants shall provide:

#### General Information

- a.  Plan view and typical cross-section view sheets that show the existing and proposed conditions. These illustrations should each be identified with a figure number, date of the map, the project title, the name of the applicant and the type of illustration (vicinity map, plan view, or cross section).
- b.  Drawings, sketches, or plans that are legible, reproducible (color is encouraged, but features must be distinguishable in black and white), drawn to scale, and no larger than 11"x17" and 10 MB when submitted in digital format. Numeric and graphic/bar scales must agree, and plan details must be measurable using a standard engineer's scale on printed plans. Reduced plans are not acceptable.
- c.  The north arrow and remove miscellaneous non-wetland or water project related features such as conduits, utility poles, guardrails, etc.

<sup>20</sup> See definitions section for the definitions of direct, indirect, secondary impacts.

- d.  Clearly draw the overall limits of work, staging areas, disposal sites, access routes, and any permittee responsible mitigation sites. These areas may include both aquatic resources and upland areas.
- e.  Names or numbers of all roads in the site's vicinity and ownership and numbers of abutting parcels.
- f.  Datum in plan and elevation views. The horizontal datum shall be in the NAD 83 Massachusetts State Plane Coordinate System (INSERT) in U.S. survey feet. The vertical data in coastal projects shall be referenced to either MLLW or the North American Vertical Datum of 1988 (NAVD 88). Both the distance and depth units shall be U.S. survey feet and specified on the project plans.

**Aquatic Resources & Project Impacts**

- g.  Delineation of all aquatic resource types on site including salt marsh; other special aquatic sites (vegetated shallows, mudflats, riffles and pools, coral reefs, and sanctuaries and refuges); other waters, such as lakes, ponds, vernal pools, natural rocky habitat (tidal only), and perennial, intermittent, and ephemeral streams.
- h.  Identify the substrate type (cobble/gravel, organic detritus, sand/shell, silt, mud) and the approximate percentage of each substrate type on site. Grain sizes shall be based on Wentworth grain size classification scale for granules, pebbles, cobbles, and boulders. Sediment samples with a content of 10% or more of pebble-gravel-cobble and/or boulder in the top layer (6-12 inches) should be delineated and material with epifauna/macroalgae should be differentiated from bare pebble-gravel-cobble and boulder.
- i.  The direction of ebb and flood in tidal waters and direction of flow in non-tidal waters.
- j.  In tidal waters, the project boundary distance from special aquatic sites identified in 20g above if within 25 feet from that resource.
- k.  USACE jurisdictional boundaries including ordinary high-water mark (OHWM), high tide line (HTL), mean high water (MHW). Other boundaries include mean low water (MLW), mean lower low water (MLLW), as applicable.
  - Non-tidal: OHWM and/or wetland boundaries.
  - Tidal (structures/work only): MHW, MLW.
  - Tidal (Fill and Structures/work): HTL, MHW, MLW.
  - Tidal (Dredging/Beach Nourishment): HTL, MHW, MLW, MLLW.
- l.  Identification of each aquatic resource with a unique name (ex. Wetland 1, Wetland 2, Tributary 1, Beaver Brook, Atlantic Ocean) and the size of each aquatic resource within the project area (square feet or acres).
- m.  Impacts to each aquatic resource with captions denoting the size of each impact (square feet, acres, or linear feet) and the duration of the impact (ex. Permanent, Temporary (X days)).

**SECTION 4C: PROJECT PLANS - SPECIFIC PROJECT INFORMATION**

- 21.  For projects involving Navigation, Structures, Dredging, and/or Beach Nourishment, the applicant shall also address the following:

**Navigation**

- a.  Identify the locations of adjacent Federal navigation project (FNP) and/or state/local navigation projects on the project plans.
- b.  Specify the distance between the FNP and proposed project boundary, the authorized depths of the FNP, and state plane coordinates of seaward end(s) of project structures near an FNP.

### Structures

- a.  Identification of the piling type (steel, timber, concrete) and diameter to be removed and/or installed.
- b.  Specify the minimal height of the structures' frame over saltmarsh. To meet the SV threshold, piers must be  $\leq 4$  feet in width and this minimal height must achieve a 1.5:1 ratio (i.e., a 4-foot-wide pier is 6 feet above a saltmarsh).
- c.  For floats, the methods of securing them (piles, bottom anchors) and for keeping them off substrate (skids, stops) at low water. To meet the SV threshold, a minimum depth of 18-inches of water should be maintained below a floating dock/structure at lower tide levels.

### Dredging

- a.  The area (SF, acre) and volume (CY) of material to be dredged waterward of MHW for each dredge location.
- b.  Dredge boundaries.
- c.  Bathymetry for existing, proposed, and historical (include dates and USACE permits) dredge depths.
- d.  The likely final angle of repose of the side cuts based on the physical characterization of the material to be dredged and based upon the high/ medium/low, wave or current energy of the location.
- e.  Label area whether the dredging is new, maintenance, improvement, or a combination.
- f.  Location of the disposal site (include location sheet). NOTE: For projects proposing open water, nearshore disposal, or beach nourishment, contact USACE as early as possible for sampling and testing protocols. Sediment testing, including physical (e.g., grain-size analysis), chemical and biological testing may be required. Sampling/testing of sediments without such contact should not occur and if done, will be at the applicant's risk.
- g.  The methods and areas used to retain or prevent dredged material from running back into the wetland or waterway. Provide the capacity of the storage area and points of runback, including the overflow route, into the aquatic system.
- h.  For open-water disposal, explain why inland or beneficial reuse sites are not practicable.
- i.  Show the finished top elevation of the disposal site.

### Beach Nourishment

- a.  For beach nourishment, identify the disposal footprint, existing and proposed nourishment profiles (multiple profiles are appropriate if the site is more than 150 feet long or non-contiguous), total fill area (SF) and volume (CY), fill area and volume waterward of the HTL, and delineation of dunes, banks, existing beach vegetation, and contours.
- b.  For beach nourishment identify the substrate type (fine sand, sand, cobble, boulder) and/or grain-size of existing material.

## **SECTION 5: STRUCTURES**

22.  For projects with the removal of existing pilings identify the number, type (steel, timber, concrete) and diameter of pilings to be removed and the methodology for removal (cut off at mud line, pulling, vibratory, etc.).
23.  For projects with the installation of new pilings identify the number, type (steel, timber, concrete) and diameter of pilings to be installed and the methodology for installation (vibratory hammer, impact hammer etc.).
24.  Identify any existing structures and moorings in waters adjacent to the proposed activity, their dimensions, and the distance to the limits and coordinates of any proposed mooring field or reconfiguration zone. For reconfiguration zone and mooring fields, provide the coordinates for all

corners based on the Massachusetts State Plane Coordinate System. Specify the maximum number of slips and/or moorings within proposed reconfiguration zones or anchorage areas.

- 25.  The dimensions of the structure or work and extent of encroachment waterward of MHW and from affixed point on the shoreline or upland.
- 26.  Shoreline of adjacent properties and property boundary offset for structures. In narrow waterbodies, the distance to opposite shoreline, waterway width, and structures across from proposed work.
- 27.  For new commercial boating facilities, anchorage areas or reconfiguration zones, provide a description of the type of vessels that would use the facility, and any plans for sewage pump-out facilities, fueling facilities and contingency plans for oil spills.
- 28.  See Sections 4A-C above.

### **SECTION 6: AQUACULTURE**

- 29.  Identify the coordinates for lease area corners and gear configuration area on the project plans.
- 30.  Identify the proposed aquaculture gear type (buoys, floats, racks, trays, nets, lines, tubes, cages, containers, and other structures). Provide the impacts for each aquaculture gear type (see Section 4A 19a-d).
- 31.  For a GP 18 to be valid, applicants must have (a) their MA DMF Aquaculture Certification letter for licensed shellfish aquaculture sites, (b) documentation that the applicant has coordinated with the U.S. Coast Guard regarding USCG Private Aids to Navigation standards, (c) their MEPA Certificate (if required), and (d) documentation that the applicant has contacted their local authorities (ex. harbormaster, select board, shellfish constable) for authorization of their facility.
- 32. Provide information on site the operation, maintenance, and access. Will the site be accessed via boat, kayak, etc.? Will cages be removed in the winter? How often will gear be checked on? Is there an operations plan for the proposed aquaculture area?
- 33.  See Sections 4A-C above.

### **SECTION 7: DREDGING**

- 34.  Sampling plan requests for new, improvement or maintenance dredging must submit completed [Dredged Material Evaluation checklist found at Dredged Material Evaluation Checklist, Sampling and Analysis Plan Requirements from Applicant \(army.mil\)](#) and identify the method of handling/transporting the dredged material.
- 35.  Identify grain-size of material to be dredged (e.g., silty sand) and provide any existing sediment grain size and bulk sediment chemistry data from the proposed project or nearby projects. Include information on any recent spills of oil and/or other hazardous materials and/or nearby outfalls. Document the information source, e.g., EPA database, the harbormaster or fire chief. If there are none, state "none".
- 36.  See Section 4A, 4B and 4C, Dredging 21(a-i) above.

### **SECTION 8: WETLAND/WATERBODY CROSSINGS**

- 37.  For the stream crossing, identify the crossing methodology on the project plan (e.g., dam and pump, dry, wet, etc.). Submit a waterway crossing sequencing plan with the application.
- 38.  If the project includes a permanent crossing of a tidal waterway, your project design should be modified to match the velocity, depth, cross-sectional area, and substrate of the existing waterbody adjacent to the crossing and provide documentation (hydraulic analysis including low lying property analysis) that the size of the crossing will not restrict tidal flow over the full natural tide range and will not adversely affect abutting infrastructure.

39.  If the work includes a permanent crossing of a non-tidal stream, your project design should be modified to match the culvert gradient of the existing stream channel profile, provide clearance for  $\geq 1.2$  times bank full width and conveyance should be embedded  $\geq 1-2$  feet for box culverts and pipe arches or  $\geq 1-2$  feet and at least 25 percent for rounded pipes/culverts in accordance with the Massachusetts Stream Crossing Standards. Provide the basis for any variation to this requirement.
40.  If the work includes a permanent crossing of a non-tidal stream, the structure should be designed to include a natural bottom substrate within the conveyance that matches the characteristics of the substrate in the natural stream channel and the character of the banks (mobility, slope, stability, confinement, grain and rock size). The conveyance should be designed with a minimum openness ratio  $\geq 0.82$ -feet (0.25-meters). For how to calculate openness ratio and stream simulation ecological approach for road and stream crossings, see <https://www.nae.usace.army.mil/Missions/Regulatory/Stream-and-River-Continuity/>.

### **SECTION 9: COMPENSATORY MITIGATION**

41.  Does the project require Compensatory Mitigation<sup>21</sup> for impacts to Waters of the U.S.? (See Section V in the 2023 Massachusetts General Permit)
42.  If the project requires mitigation, does the selected compensatory mitigation option (i.e., In-Lieu Fee, permittee-responsible mitigation) deviate from the order of the options presented in §332.3(b)(2)-(6)? If so, please explain why. <https://www.ecfr.gov/current/title-33/chapter-II/part-332/section-332.3>
43.  For any compensatory mitigation that involves preservation, the applicant must use a site protection instrument to preserve the parcel in perpetuity. (Conservation Easement, Deed Restriction, etc.) <https://www.mass.gov/service-details/conservation-restriction-review-program>.

### **SECTION 10: HISTORIC PROPERTIES & NOTIFICATIONS TO SHPO, THPOs, BUAR**

44.  Notify the SHPO, Massachusetts Historical Commission, of the Project via Certified Mail and include proof of delivery or receipt in the application package (See Appendix A).
45.  As applicable, notify the THPOs, Narragansett Indian Tribe, Wampanoag Tribe of Gay Head (Aquinnah), and Mashpee Wampanoag Tribe, of the Project via email OR mail and include proof of delivery or receipt in the application package (See Appendix A).
46.  As applicable, notify the BUAR via email (*strongly preferred*) OR mail and include proof of delivery or receipt in the application package (See Appendix A).
47.  Include responses to this notification in the permit application.
48.  As applicable, information on historic properties (Tribal and Archaeological) within the project area should be provided in the permit application.

### **SECTION 11: ENDANGERED SPECIES & ESSENTIAL FISH HABITAT**

49.  Provide a USFWS Information for Planning and Consultation (IPaC) Official Species List from <https://ecos.fws.gov/ipac> and the email of the individual who generated the list (see GC 10 of the 2023 Massachusetts General Permit for more information).
50.  Provide a species list from the NMFS Section 7 Endangered Species Act mapper at <https://noaa.maps.arcgis.com/apps/webappviewer/index.html>.
51.  Provide a species list from the NMFS Essential Fish Habitat Mapper at [https://www.habitat.noaa.gov/apps/efhmapper/?page=page\\_3](https://www.habitat.noaa.gov/apps/efhmapper/?page=page_3).

<sup>21</sup> Your mitigation proposal must be consistent with the December 29, 2020 Compensatory Mitigation Standard Operating Procedures at <https://www.nae.usace.army.mil/Portals/74/docs/regulatory/Mitigation/Compensatory-Mitigation-SOP-2020.pdf> and 2008 Mitigation Rule.



52.  If the project will generate turbidity, describe the extent of turbidity and if erosion controls will be used to contain turbidity. If turbidity controls are not operationally feasible, explain the basis for your conclusion and identify any other measures that you will implement to minimize resuspension of sediment.
53.  Identify the substrate type and any aquatic resources that will be affected by the proposed action. (SAV, salt marsh, sand, silt/clay, rocky/hard bottom)
54.  For projects which will include the installation of pilings/sheet-piles, identify the substrate at the project site (sand, cobble, silt/mud/clay), the installation method (vibratory hammer, impact hammer, combination) and indicate whether the following “soft start” procedures at beginning of the workday and after a 30-minute period of rest will be deployed:
  - a.  Vibratory Pile Installation: pile driving will be initiated for 15 seconds at reduced energy followed by a one-minute waiting period. This sequence of 15 seconds of reduced energy driving, one-minute waiting period will be repeated two additional times, followed immediately by pile-driving at full rate and energy.
  - b.  Impact Pile Installation: pile driving will commence with an initial set of three strikes by the hammer at 40% energy, followed by a one-minute wait period, then two subsequent 3-strike sets at 40% energy, with one-minute waiting periods, before initiating continuous impact driving.
55.  If the project involves dredging, describe any dredge history, number of dredge events to be covered by the permit, erosion/sediment controls, dredge type, intake structures (mesh screen size), dredged material disposal site.
56.  For project activities associated with structures, identify the number, type (drill barge, work boat, tugboat, etc.), and size of any temporary vessels that will be used. Specify measures that will be implemented to ensure vessels are not berthed in shallow water or will “ground out” at low tide.
57.  For aquaculture projects identify whether any component of the gear is seasonal (will be removed annually) or will be in place year-round. If gear will be present year-round and will be variably managed (e.g., floating in summer, bottom in winter) identify month/date for such configurations.
58.  For aquaculture projects identify whether the project will involve use of an existing vessel or new vessel. Identify the length for all work vessels and identify the distance round trip from vessel berthing location and aquaculture area.
59.  For project activities associated with docking structures (either commercial, industrial, or recreational) identify the number, type (motorized/non-motorized, jet-ski, sailboat, kayak, canoe, other that will be berthed there and the sizes of each.
60.  Information required for Section 305(b)(2) of the Magnuson-Stevens Fishery Conservation and Management Act:
  - a. Results of an eelgrass survey completed per the INSERT.
  - b. Essential Fish Habitat Assessment to determine project-related impacts to essential fish habitat, using guidance developed by the National Marine Fisheries Service.
61.  A document containing the following information (requirements of 50 CFR §600.920(e)(3)):
  - a. Description of proposed action.
  - b. Analysis of potential adverse effects on essential fish habitat.
  - c. Conclusions regarding the effects of the action on essential fish habitat.
  - d. If applicable, proposed mitigation.
  - e. Analysis of alternatives to the proposed action.
  - f. Other:

THIS PAGE INTENTIONALLY LEFT BLANK

DOCUMENT A00860

**MASSACHUSETTS**

**DEPARTMENT OF ENVIRONMENTAL PROTECTION**

**NOTICE OF INTENT**

THIS PAGE INTENTIONALLY LEFT BLANK



# Notice of Intent Fitchburg Conservation Commission

## River Street Bridge Replacement Fitchburg, MA

July 2023

**Prepared For:**

Massachusetts Department of  
Transportation  
10 Park Plaza  
Boston, MA 02116

**Prepared By:**

TRC  
650 Suffolk St.  
Suite 200  
Lowell, MA 01854





650 Suffolk St., Suite 200  
Lowell, MA 01854

T 978.970.5600  
TRCcompanies.com

July 19, 2023

Town of Fitchburg Conservation Commission  
718 Main Street  
Fitchburg, MA 01420

RE: River Street Bridge Replacement  
Notice of Intent (NOI)

Dear Commissioners:

On behalf of the Massachusetts Department of Transportation (MassDOT), TRC Companies (TRC) is pleased to submit the enclosed Notice of Intent (NOI) for the replacement of an existing stormwater outfall associated with the River Street Bridge Replacement Project in Fitchburg, MA.

This NOI is being filed with the Fitchburg Conservation Commission (FCC) pursuant to the Massachusetts Wetland Protection Act (WPA; M.G.L. Ch. 131, § 40) and its Regulations (310 CMR 10.00). While the Project has been designed to limit impacts to resource areas subject to protection under the WPA, segments of the Project are located within resource areas including Bank, Land Under Waterbodies and Waterways, Riverfront Area, Bordering Land Subject to Flooding, and Buffer Zone. As an agency of the Commonwealth providing essential government functions, MassDOT is exempt from certain municipal requirements including but not limited to wetland bylaws, ordinances and policies, and for paying peer review fees. Additionally, MassDOT is not required to notify abutters per the WPA Regulations at 310 CMR 10.05(4).

We trust that the enclosed information meets the requirements of the Fitchburg Conservation Commission to issue an Order of Conditions for the proposed Project and appreciate your review of this information. The replacement outfall will tie into structures to be installed as part of the City of Fitchburg CSO 010 Separation/Rehabilitation Project. Plans for that project are available upon request. If you should have any questions about this NOI, please do not hesitate to contact me at (978) 941-5834 or via email at [grusso@trccompanies.com](mailto:grusso@trccompanies.com).

Sincerely,  
TRC Environmental Corporation

A handwritten signature in black ink on a light-colored rectangular background. The signature appears to read "Gregory Russo".

Gregory Russo  
Senior Wetland Scientist



**TABLE OF CONTENTS**

**WPA FORM 3 – NOTICE OF INTENT**

**FILING FEE DOCUMENTATION**

**ATTACHMENT A – Project Narrative**

**1.0 INTRODUCTION..... 1**

**2.0 SITE DESCRIPTION AND EXISTING CONDITIONS ..... 2**

2.1 Jurisdictional Resource Areas ..... 2

2.1.1 Riverfront Area ..... 2

2.1.2 Bordering Land Subject to Flooding..... 2

2.1.3 Bank..... 3

2.1.4 Land Under Waterbodies and Waterways ..... 3

2.1.5 Buffer Zones..... 3

**3.0 PROPOSED PROJECT DESCRIPTION ..... 4**

3.1 Work Descriptions ..... 4

3.1.1 Erosion and Sedimentation Controls ..... 4

3.1.2 Temporary Cofferdam ..... 4

3.1.3 Brush Clearing and Site Preparation ..... 4

3.1.4 Equipment Access ..... 4

3.1.5 New Sewer Outfall and Partial Demolition /Reconstruction of Flood Wall..... 5

3.1.6 Removal of Existing Drainage Outfall ..... 5

**4.0 IMPACTS, PERFORMANCE STANDARDS, AND MITIGATION MEASURES ..... 6**

4.1 Best Management Practices ..... 6

4.2 Riverfront Area ..... 6

4.3 Bank ..... 8

4.4 LUW ..... 9

4.5 BLSF ..... 10

4.6 Buffer Zone ..... 11

4.7 Stormwater Management..... 11

**ATTACHMENT B – Figures and Plans**

**ATTACHMENT C – IPaC Consultation**

**ATTACHMENT D – Photo Log**

**ATTACHMENT E – Stormwater Report**



---

**WPA FORM 3 – NOTICE OF INTENT**





**Massachusetts Department of Environmental Protection**  
 Bureau of Resource Protection - Wetlands

**WPA Form 3 – Notice of Intent**

Massachusetts Wetlands Protection Act M.G.L. c. 131, §40

Provided by MassDEP:

---

MassDEP File Number

---

Document Transaction Number

---

Fitchburg

---

City/Town

**Important:**  
 When filling out forms on the computer, use only the tab key to move your cursor - do not use the return key.



Note:  
 Before completing this form consult your local Conservation Commission regarding any municipal bylaw or ordinance.

**A. General Information**

1. Project Location (**Note:** electronic filers will click on button to locate project site):

|   |   |                             |
|---|---|-----------------------------|
| <u>0 Main Street</u><br>a. Street Address       | <u>Fitchburg</u><br>b. City/Town        | <u>01420</u><br>c. Zip Code |
| Latitude and Longitude:                         |   |                             |
| <u>Block 29</u><br>f. Assessors Map/Plat Number | <u>29-15-0</u><br>g. Parcel /Lot Number | <u></u><br>e. Longitude     |

2. Applicant:

|   |                               |   |
|---|-------------------------------|---|
| <u>Melissa</u><br>a. First Name   | <u>Lenker</u><br>b. Last Name |   |
| <u>Massachusetts Department of Transportation - Highway Division</u><br>c. Organization |                               |   |
| <u>10 Park Plaza, Room 7360</u><br>d. Street Address                                    |                               |   |
| <u>Boston</u><br>e. City/Town   | <u>MA</u><br>f. State         | <u>02116</u><br>g. Zip Code                               |
| <u>(978) 429-1772</u><br>h. Phone Number  | <u></u><br>i. Fax Number      | <u>melissa.lenker@dot.state.ma.us</u><br>j. Email Address |

3. Property owner (required if different from applicant):  Check if more than one owner

|  |                          |                             |
|--|--------------------------|-----------------------------|
| <u></u><br>a. First Name   | <u></u><br>b. Last Name  |                             |
| <u>Massachusetts Department of Transportaion - Highway Division</u><br>c. Organization |                          |                             |
| <u>10 Park Plaza</u><br>d. Street Address  |                          |                             |
| <u>Boston</u><br>e. City/Town  | <u>MA</u><br>f. State    | <u>02116</u><br>g. Zip Code |
| <u></u><br>h. Phone Number   | <u></u><br>i. Fax Number | <u></u><br>j. Email address |

4. Representative (if any):

|  |                              |  |
|--|------------------------------|--|
| <u>Gregory</u><br>a. First Name                | <u>Russo</u><br>b. Last Name |  |
| <u>TRC</u><br>c. Company                       |                              |  |
| <u>650 Suffolk Street</u><br>d. Street Address |                              |  |
| <u>Lowell</u><br>e. City/Town                  | <u>MA</u><br>f. State        | <u>01854</u><br>g. Zip Code                        |
| <u>978-941-5834</u><br>h. Phone Number         | <u></u><br>i. Fax Number     | <u>grusso@trccompanies.com</u><br>j. Email address |

5. Total WPA Fee Paid (from NOI Wetland Fee Transmittal Form):

|                                      |                                      |  |
|--------------------------------------|--------------------------------------|--|
| <u>\$750.00</u><br>a. Total Fee Paid | <u>\$362.50</u><br>b. State Fee Paid | <u>\$387.50</u><br>c. City/Town Fee Paid |
|--------------------------------------|--------------------------------------|--|

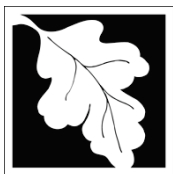

Massachusetts Department of Environmental Protection  
Bureau of Resource Protection - Wetlands

# WPA Form 3 – Notice of Intent

Massachusetts Wetlands Protection Act M.G.L. c. 131, §40

Provided by MassDEP:

MassDEP File Number

Document Transaction Number

Fitchburg  
City/Town

## A. General Information (continued)

### 6. General Project Description:

The City of Fitchburg has requested to upgrade of the existing 12" stormwater outfall with a 60" diameter outfall as part of the Project. This will tie into the City's proposed CSO 010 storm/sewer separation/rehabilitation project.

### 7a. Project Type Checklist: (Limited Project Types see Section A. 7b.)

- 1.  Single Family Home
- 2.  Residential Subdivision
- 3.  Commercial/Industrial
- 4.  Dock/Pier
- 5.  Utilities
- 6.  Coastal engineering Structure
- 7.  Agriculture (e.g., cranberries, forestry)
- 8.  Transportation
- 9.  Other

### 7b. Is any portion of the proposed activity eligible to be treated as a limited project (including Ecological Restoration Limited Project) subject to 310 CMR 10.24 (coastal) or 310 CMR 10.53 (inland)?

- 1.  Yes  No      If yes, describe which limited project applies to this project. (See 310 CMR 10.24 and 10.53 for a complete list and description of limited project types)

#### 2. Limited Project Type

If the proposed activity is eligible to be treated as an Ecological Restoration Limited Project (310 CMR10.24(8), 310 CMR 10.53(4)), complete and attach Appendix A: Ecological Restoration Limited Project Checklist and Signed Certification.

### 8. Property recorded at the Registry of Deeds for:

Worcester

a. County

b. Certificate # (if registered land)

c. Book

d. Page Number

## B. Buffer Zone & Resource Area Impacts (temporary & permanent)

- 1.  Buffer Zone Only – Check if the project is located only in the Buffer Zone of a Bordering Vegetated Wetland, Inland Bank, or Coastal Resource Area.
- 2.  Inland Resource Areas (see 310 CMR 10.54-10.58; if not applicable, go to Section B.3, Coastal Resource Areas).

Check all that apply below. Attach narrative and any supporting documentation describing how the project will meet all performance standards for each of the resource areas altered, including standards requiring consideration of alternative project design or location.



**Massachusetts Department of Environmental Protection**  
 Bureau of Resource Protection - Wetlands

**WPA Form 3 – Notice of Intent**

Massachusetts Wetlands Protection Act M.G.L. c. 131, §40

Provided by MassDEP:

---

MassDEP File Number

---

Document Transaction Number

---

Fitchburg

---

City/Town

**B. Buffer Zone & Resource Area Impacts (temporary & permanent) (cont'd)**

For all projects affecting other Resource Areas, please attach a narrative explaining how the resource area was delineated.

| <u>Resource Area</u>  | <u>Size of Proposed Alteration</u>   | <u>Proposed Replacement (if any)</u> |
|---|--|--------------------------------------|
| a. <input checked="" type="checkbox"/> Bank                                 | <u>37 (temporary)</u><br>1. linear feet  | _____<br>2. linear feet              |
| b. <input type="checkbox"/> Bordering Vegetated Wetland                     | _____<br>1. square feet  | _____<br>2. square feet              |
| c. <input checked="" type="checkbox"/> Land Under Waterbodies and Waterways | <u>150 (temporary)</u><br>1. square feet<br><u>0</u><br>3. cubic yards dredged | _____<br>2. square feet              |

| <u>Resource Area</u>  | <u>Size of Proposed Alteration</u>  | <u>Proposed Replacement (if any)</u>                       |
|---|---|--|
| d. <input checked="" type="checkbox"/> Bordering Land Subject to Flooding | <u>1,341 (temporary)</u><br>1. square feet<br>_____<br>3. cubic feet of flood storage lost                  | _____<br>2. square feet<br>_____<br>4. cubic feet replaced |
| e. <input type="checkbox"/> Isolated Land Subject to Flooding             | _____<br>1. square feet<br>_____<br>2. cubic feet of flood storage lost                                     | _____<br>3. cubic feet replaced                            |
| f. <input checked="" type="checkbox"/> Riverfront Area                    | <u>North Nashua River (inland)</u><br>1. Name of Waterway (if available) - <b>specify coastal or inland</b> | _____  |

2. Width of Riverfront Area (check one):

- 25 ft. - Designated Densely Developed Areas only
- 100 ft. - New agricultural projects only
- 200 ft. - All other projects

3. Total area of Riverfront Area on the site of the proposed project: 10,247 square feet

4. Proposed alteration of the Riverfront Area:

|                          |                               |  |
|--------------------------|-------------------------------|--|
| <u>1,341 (temporary)</u> | <u>1,341 (temporary)</u>      | <u>0</u>                                   |
| a. total square feet     | b. square feet within 100 ft. | c. square feet between 100 ft. and 200 ft. |

5. Has an alternatives analysis been done and is it attached to this NOI?  Yes  No

6. Was the lot where the activity is proposed created prior to August 1, 1996?  Yes  No

3.  Coastal Resource Areas: (See 310 CMR 10.25-10.35)

**Note:** for coastal riverfront areas, please complete **Section B.2.f.** above.



**Massachusetts Department of Environmental Protection**  
 Bureau of Resource Protection - Wetlands

**WPA Form 3 – Notice of Intent**

Massachusetts Wetlands Protection Act M.G.L. c. 131, §40

Provided by MassDEP:

---

MassDEP File Number

---

Document Transaction Number

---

Fitchburg

---

City/Town

**B. Buffer Zone & Resource Area Impacts (temporary & permanent) (cont'd)**

Check all that apply below. Attach narrative and supporting documentation describing how the project will meet all performance standards for each of the resource areas altered, including standards requiring consideration of alternative project design or location.

Online Users:  
 Include your document transaction number (provided on your receipt page) with all supplementary information you submit to the Department.

| <u>Resource Area</u>  | <u>Size of Proposed Alteration</u>  | <u>Proposed Replacement (if any)</u>      |
|---|---|---|
| a. <input type="checkbox"/> Designated Port Areas                 | Indicate size under Land Under the Ocean, below   |   |
| b. <input type="checkbox"/> Land Under the Ocean                  | _____   |   |
|   | 1. square feet  |   |
|   | _____   |   |
|   | 2. cubic yards dredged  |   |
| c. <input type="checkbox"/> Barrier Beach                         | Indicate size under Coastal Beaches and/or Coastal Dunes below  |   |
| d. <input type="checkbox"/> Coastal Beaches                       | _____   | _____                                     |
|   | 1. square feet  | 2. cubic yards beach nourishment          |
| e. <input type="checkbox"/> Coastal Dunes                         | _____   | _____                                     |
|   | 1. square feet  | 2. cubic yards dune nourishment           |
|   | <u>Size of Proposed Alteration</u>  | <u>Proposed Replacement (if any)</u>      |
| f. <input type="checkbox"/> Coastal Banks                         | _____   |   |
|   | 1. linear feet  |   |
| g. <input type="checkbox"/> Rocky Intertidal Shores               | _____   |   |
|   | 1. square feet  |   |
| h. <input type="checkbox"/> Salt Marshes                          | _____   | _____                                     |
|   | 1. square feet  | 2. sq ft restoration, rehab., creation    |
| i. <input type="checkbox"/> Land Under Salt Ponds                 | _____   |   |
|   | 1. square feet  |   |
|   | _____   |   |
|   | 2. cubic yards dredged  |   |
| j. <input type="checkbox"/> Land Containing Shellfish             | _____   |   |
|   | 1. square feet  |   |
| k. <input type="checkbox"/> Fish Runs                             | Indicate size under Coastal Banks, inland Bank, Land Under the Ocean, and/or inland Land Under Waterbodies and Waterways, above   |   |
|   | _____   |   |
|   | 1. cubic yards dredged  |   |
| l. <input type="checkbox"/> Land Subject to Coastal Storm Flowage | _____   |   |
|   | 1. square feet  |   |
| 4. <input type="checkbox"/> Restoration/Enhancement               | If the project is for the purpose of restoring or enhancing a wetland resource area in addition to the square footage that has been entered in Section B.2.b or B.3.h above, please enter the additional amount here. |   |
|   | _____   | _____                                     |
|   | a. square feet of BVW   | b. square feet of Salt Marsh              |
| 5. <input type="checkbox"/> Project Involves Stream Crossings     |   |   |
|   | _____   | _____                                     |
|   | a. number of new stream crossings   | b. number of replacement stream crossings |



**Massachusetts Department of Environmental Protection**  
 Bureau of Resource Protection - Wetlands

**WPA Form 3 – Notice of Intent**

Massachusetts Wetlands Protection Act M.G.L. c. 131, §40

Provided by MassDEP:

MassDEP File Number

Document Transaction Number

Fitchburg  
 City/Town

**C. Other Applicable Standards and Requirements**

- This is a proposal for an Ecological Restoration Limited Project. Skip Section C and complete Appendix A: Ecological Restoration Limited Project Checklists – Required Actions (310 CMR 10.11).

**Streamlined Massachusetts Endangered Species Act/Wetlands Protection Act Review**

1. Is any portion of the proposed project located in **Estimated Habitat of Rare Wildlife** as indicated on the most recent Estimated Habitat Map of State-Listed Rare Wetland Wildlife published by the Natural Heritage and Endangered Species Program (NHESP)? To view habitat maps, see the *Massachusetts Natural Heritage Atlas* or go to [http://maps.massgis.state.ma.us/PRI\\_EST\\_HAB/viewer.htm](http://maps.massgis.state.ma.us/PRI_EST_HAB/viewer.htm).

- a.  Yes  No **If yes, include proof of mailing or hand delivery of NOI to:**

**Natural Heritage and Endangered Species Program**  
**Division of Fisheries and Wildlife**  
 1 Rabbit Hill Road  
 Westborough, MA 01581

- August 2021  
 b. Date of map

If yes, the project is also subject to Massachusetts Endangered Species Act (MESA) review (321 CMR 10.18). To qualify for a streamlined, 30-day, MESA/Wetlands Protection Act review, please complete Section C.1.c, and include requested materials with this Notice of Intent (NOI); OR complete Section C.2.f, if applicable. *If MESA supplemental information is not included with the NOI, by completing Section 1 of this form, the NHESP will require a separate MESA filing which may take up to 90 days to review (unless noted exceptions in Section 2 apply, see below).*

- c. Submit Supplemental Information for Endangered Species Review\*

1.  Percentage/acreage of property to be altered:
  - (a) within wetland Resource Area \_\_\_\_\_ percentage/acreage
  - (b) outside Resource Area \_\_\_\_\_ percentage/acreage
2.  Assessor's Map or right-of-way plan of site

2.  Project plans for entire project site, including wetland resource areas and areas outside of wetlands jurisdiction, showing existing and proposed conditions, existing and proposed tree/vegetation clearing line, and clearly demarcated limits of work \*\*
  - (a)  Project description (including description of impacts outside of wetland resource area & buffer zone)
  - (b)  Photographs representative of the site

\* Some projects **not** in Estimated Habitat may be located in Priority Habitat, and require NHESP review (see <https://www.mass.gov/endangered-species-act-mesa-regulatory-review>).

Priority Habitat includes habitat for state-listed plants and strictly upland species not protected by the Wetlands Protection Act.

\*\* MESA projects may not be segmented (321 CMR 10.16). The applicant must disclose full development plans even if such plans are not required as part of the Notice of Intent process.

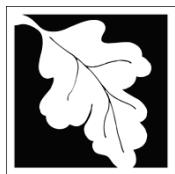

Massachusetts Department of Environmental Protection  
Bureau of Resource Protection - Wetlands

# WPA Form 3 – Notice of Intent

Massachusetts Wetlands Protection Act M.G.L. c. 131, §40

Provided by MassDEP:

MassDEP File Number

Document Transaction Number

Fitchburg  
City/Town

## C. Other Applicable Standards and Requirements (cont'd)

(c)  MESA filing fee (fee information available at <https://www.mass.gov/how-to/how-to-file-for-a-mesa-project-review>).

Make check payable to "Commonwealth of Massachusetts - NHESP" and **mail to NHESP** at above address

*Projects altering 10 or more acres of land, also submit:*

(d)  Vegetation cover type map of site

(e)  Project plans showing Priority & Estimated Habitat boundaries

(f) OR Check One of the Following

1.  Project is exempt from MESA review.  
Attach applicant letter indicating which MESA exemption applies. (See 321 CMR 10.14, <https://www.mass.gov/service-details/exemptions-from-review-for-projectsactivities-in-priority-habitat>; the NOI must still be sent to NHESP if the project is within estimated habitat pursuant to 310 CMR 10.37 and 10.59.)

2.  Separate MESA review ongoing. a. NHESP Tracking # \_\_\_\_\_ b. Date submitted to NHESP \_\_\_\_\_

3.  Separate MESA review completed.  
Include copy of NHESP "no Take" determination or valid Conservation & Management Permit with approved plan.

3. For coastal projects only, is any portion of the proposed project located below the mean high water line or in a fish run?

a.  Not applicable – project is in inland resource area only      b.  Yes     No

If yes, include proof of mailing, hand delivery, or electronic delivery of NOI to either:

South Shore - Cohasset to Rhode Island border, and the Cape & Islands:

North Shore - Hull to New Hampshire border:

Division of Marine Fisheries -  
Southeast Marine Fisheries Station  
Attn: Environmental Reviewer  
836 South Rodney French Blvd.  
New Bedford, MA 02744  
Email: [dmf.envreview-south@mass.gov](mailto:dmf.envreview-south@mass.gov)

Division of Marine Fisheries -  
North Shore Office  
Attn: Environmental Reviewer  
30 Emerson Avenue  
Gloucester, MA 01930  
Email: [dmf.envreview-north@mass.gov](mailto:dmf.envreview-north@mass.gov)

Also if yes, the project may require a Chapter 91 license. For coastal towns in the Northeast Region, please contact MassDEP's Boston Office. For coastal towns in the Southeast Region, please contact MassDEP's Southeast Regional Office.

c.  Is this an aquaculture project?      d.  Yes     No

If yes, include a copy of the Division of Marine Fisheries Certification Letter (M.G.L. c. 130, § 57).

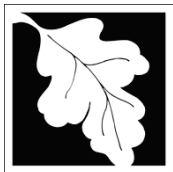

Massachusetts Department of Environmental Protection  
Bureau of Resource Protection - Wetlands

**WPA Form 3 – Notice of Intent**

Massachusetts Wetlands Protection Act M.G.L. c. 131, §40

Provided by MassDEP:

MassDEP File Number

Document Transaction Number

Fitchburg  
City/Town

**C. Other Applicable Standards and Requirements (cont'd)**

**Online Users:**  
Include your document transaction number (provided on your receipt page) with all supplementary information you submit to the Department.

- 4. Is any portion of the proposed project within an Area of Critical Environmental Concern (ACEC)?  
 a.  Yes  No If yes, provide name of ACEC (see instructions to WPA Form 3 or MassDEP Website for ACEC locations). **Note:** electronic filers click on Website.  
 b. ACEC

---

- 5. Is any portion of the proposed project within an area designated as an Outstanding Resource Water (ORW) as designated in the Massachusetts Surface Water Quality Standards, 314 CMR 4.00?  
 a.  Yes  No
- 6. Is any portion of the site subject to a Wetlands Restriction Order under the Inland Wetlands Restriction Act (M.G.L. c. 131, § 40A) or the Coastal Wetlands Restriction Act (M.G.L. c. 130, § 105)?  
 a.  Yes  No
- 7. Is this project subject to provisions of the MassDEP Stormwater Management Standards?  
 a.  Yes. Attach a copy of the Stormwater Report as required by the Stormwater Management Standards per 310 CMR 10.05(6)(k)-(q) and check if:
  - 1.  Applying for Low Impact Development (LID) site design credits (as described in Stormwater Management Handbook Vol. 2, Chapter 3)
  - 2.  A portion of the site constitutes redevelopment
  - 3.  Proprietary BMPs are included in the Stormwater Management System.
 b.  No. Check why the project is exempt:
  - 1.  Single-family house
  - 2.  Emergency road repair
  - 3.  Small Residential Subdivision (less than or equal to 4 single-family houses or less than or equal to 4 units in multi-family housing project) with no discharge to Critical Areas.

**D. Additional Information**

- This is a proposal for an Ecological Restoration Limited Project. Skip Section D and complete Appendix A: Ecological Restoration Notice of Intent – Minimum Required Documents (310 CMR 10.12).

Applicants must include the following with this Notice of Intent (NOI). See instructions for details.

**Online Users:** Attach the document transaction number (provided on your receipt page) for any of the following information you submit to the Department.

- 1.  USGS or other map of the area (along with a narrative description, if necessary) containing sufficient information for the Conservation Commission and the Department to locate the site. (Electronic filers may omit this item.)
- 2.  Plans identifying the location of proposed activities (including activities proposed to serve as a Bordering Vegetated Wetland [BVW] replication area or other mitigating measure) relative to the boundaries of each affected resource area.



**Massachusetts Department of Environmental Protection**  
 Bureau of Resource Protection - Wetlands

**WPA Form 3 – Notice of Intent**

Massachusetts Wetlands Protection Act M.G.L. c. 131, §40

Provided by MassDEP:

---

MassDEP File Number

---

Document Transaction Number

---

Fitchburg

---

City/Town

**D. Additional Information (cont'd)**

3.  Identify the method for BVW and other resource area boundary delineations (MassDEP BVW Field Data Form(s), Determination of Applicability, Order of Resource Area Delineation, etc.), and attach documentation of the methodology.

4.  List the titles and dates for all plans and other materials submitted with this NOI.

Massachusetts Department of Transportation Highway Division Plan and Profile of River Street (Bridge No. F-04-010) in the City of Fitchburg Worcester County

STV Incorporated and C&C Consulting Engineers LLC.

6/28/23

d. Final Revision Date

c. Signed and Stamped by

1" = 20'

e. Scale

f. Additional Plan or Document Title

g. Date

5.  If there is more than one property owner, please attach a list of these property owners not listed on this form.

6.  Attach proof of mailing for Natural Heritage and Endangered Species Program, if needed.

7.  Attach proof of mailing for Massachusetts Division of Marine Fisheries, if needed.

8.  Attach NOI Wetland Fee Transmittal Form

9.  Attach Stormwater Report, if needed.

**E. Fees**

1.  Fee Exempt: No filing fee shall be assessed for projects of any city, town, county, or district of the Commonwealth, federally recognized Indian tribe housing authority, municipal housing authority, or the Massachusetts Bay Transportation Authority.

Applicants must submit the following information (in addition to pages 1 and 2 of the NOI Wetland Fee Transmittal Form) to confirm fee payment:

1260918

2. Municipal Check Number

07/19/2023

3. Check date

1260920

4. State Check Number

07/19/2023

5. Check date

TRC

6. Payor name on check: First Name

7. Payor name on check: Last Name





Massachusetts Department of Environmental Protection  
Bureau of Resource Protection - Wetlands

### WPA Form 3 – Notice of Intent

Massachusetts Wetlands Protection Act M.G.L. c. 131, §40

Provided by MassDEP:

MassDEP File Number

Document Transaction Number

Fitchburg

City/Town

#### F. Signatures and Submittal Requirements

I hereby certify under the penalties of perjury that the foregoing Notice of Intent and accompanying plans, documents, and supporting data are true and complete to the best of my knowledge. I understand that the Conservation Commission will place notification of this Notice in a local newspaper at the expense of the applicant in accordance with the wetlands regulations, 310 CMR 10.05(5)(a).

I further certify under penalties of perjury that all abutters were notified of this application, pursuant to the requirements of M.G.L. c. 131, § 40. Notice must be made by Certificate of Mailing or in writing by hand delivery or certified mail (return receipt requested) to all abutters within 100 feet of the property line of the project location.

*Melissa Lemker*  
1. Signature of Applicant

7/19/2023  
2. Date

3. Signature of Property Owner (if different)

4. Date

*[Signature]*  
5. Signature of Representative (if any)

7/23/23  
6. Date

**For Conservation Commission:**

Two copies of the completed Notice of Intent (Form 3), including supporting plans and documents, two copies of the NOI Wetland Fee Transmittal Form, and the city/town fee payment, to the Conservation Commission by certified mail or hand delivery.

**For MassDEP:**

One copy of the completed Notice of Intent (Form 3), including supporting plans and documents, one copy of the NOI Wetland Fee Transmittal Form, and a copy of the state fee payment to the MassDEP Regional Office (see Instructions) by certified mail or hand delivery.

**Other:**

If the applicant has checked the "yes" box in any part of Section C, Item 3, above, refer to that section and the Instructions for additional submittal requirements.

The original and copies must be sent simultaneously. Failure by the applicant to send copies in a timely manner may result in dismissal of the Notice of Intent.



---

**FILING FEE DOCUMENTATION**

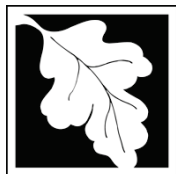

**Massachusetts Department of Environmental Protection**  
 Bureau of Resource Protection - Wetlands  
**NOI Wetland Fee Transmittal Form**  
 Massachusetts Wetlands Protection Act M.G.L. c. 131, §40

**Important:** When filling out forms on the computer, use only the tab key to move your cursor - do not use the return key.



**A. Applicant Information**

1. Location of Project:

|   |   |
|---|---|
| <u>0 Main Street</u>                      | <u>Fitchburg</u>                            |
| a. Street Address                         | b. City/Town                                |
| <u>Municipal: 1260918, State: 1260920</u> | <u>Municipal: \$387.50, State: \$362.50</u> |
| c. Check number                           | d. Fee amount                               |

2. Applicant Mailing Address:

|  |                                       |                  |
|--|---------------------------------------|------------------|
| <u>Melissa</u>   | <u>Lenker</u>                         |                  |
| a. First Name  | b. Last Name                          |                  |
| <u>Massachusetts Department of Transportation - Highway Division</u> |                                       |                  |
| c. Organization  |                                       |                  |
| <u>10 Park Plaza, Room 7360</u>                                      |                                       |                  |
| d. Mailing Address   |                                       |                  |
| <u>Boston</u>  | <u>MA</u>                             | <u>02116</u>     |
| e. City/Town   | f. State                              | g. Zip Code      |
| <u>(978) 429-1772</u>  | <u>melissa.lenker@dot.state.ma.us</u> |                  |
| h. Phone Number  | i. Fax Number                         | j. Email Address |

3. Property Owner (if different):

|  |               |                  |
|--|---------------|------------------|
| <u></u>  | <u></u>       |                  |
| a. First Name  | b. Last Name  |                  |
| <u>Massachusetts Department of Transportation - Highway Division</u> |               |                  |
| c. Organization  |               |                  |
| <u>10 Park Plaza</u>   |               |                  |
| d. Mailing Address   |               |                  |
| <u>Boston</u>  | <u>MA</u>     | <u>02116</u>     |
| e. City/Town   | f. State      | g. Zip Code      |
| <u></u>  | <u></u>       |                  |
| h. Phone Number  | i. Fax Number | j. Email Address |

**B. Fees**

Fee should be calculated using the following process & worksheet. **Please see Instructions before filling out worksheet.**

**Step 1/Type of Activity:** Describe each type of activity that will occur in wetland resource area and buffer zone.

**Step 2/Number of Activities:** Identify the number of each type of activity.

**Step 3/Individual Activity Fee:** Identify each activity fee from the six project categories listed in the instructions.

**Step 4/Subtotal Activity Fee:** Multiply the number of activities (identified in Step 2) times the fee per category (identified in Step 3) to reach a subtotal fee amount. Note: If any of these activities are in a Riverfront Area in addition to another Resource Area or the Buffer Zone, the fee per activity should be multiplied by 1.5 and then added to the subtotal amount.

**Step 5/Total Project Fee:** Determine the total project fee by adding the subtotal amounts from Step 4.

**Step 6/Fee Payments:** To calculate the state share of the fee, divide the total fee in half and subtract \$12.50. To calculate the city/town share of the fee, divide the total fee in half and add \$12.50.

To calculate filing fees, refer to the category fee list and examples in the instructions for filling out WPA Form 3 (Notice of Intent).



**Massachusetts Department of Environmental Protection**  
 Bureau of Resource Protection - Wetlands  
**NOI Wetland Fee Transmittal Form**  
 Massachusetts Wetlands Protection Act M.G.L. c. 131, §40

**B. Fees** (continued)

| Step 1/Type of Activity               | Step 2/Number of Activities | Step 3/Individual Activity Fee | Step 4/Subtotal Activity Fee         |
|---------------------------------------|-----------------------------|--------------------------------|--------------------------------------|
| Category 2 g (point source discharge) | 1                           | \$750                          | \$750                                |
| _____                                 | _____                       | _____                          | _____                                |
| _____                                 | _____                       | _____                          | _____                                |
| _____                                 | _____                       | _____                          | _____                                |
| _____                                 | _____                       | _____                          | _____                                |
| _____                                 | _____                       | _____                          | _____                                |
| _____                                 | _____                       | _____                          | _____                                |
| _____                                 | _____                       | _____                          | _____                                |
| _____                                 | _____                       | _____                          | _____                                |
| <b>Step 5/Total Project Fee:</b>      |                             |                                | \$750                                |
| <b>Step 6/Fee Payments:</b>           |                             |                                |                                      |
| Total Project Fee:                    |                             |                                | \$750                                |
| State share of filing Fee:            |                             |                                | \$362.50                             |
| City/Town share of filing Fee:        |                             |                                | \$387.50                             |
|                                       |                             |                                | a. Total Fee from Step 5             |
|                                       |                             |                                | b. 1/2 Total Fee <b>less</b> \$12.50 |
|                                       |                             |                                | c. 1/2 Total Fee <b>plus</b> \$12.50 |

**C. Submittal Requirements**

- a.) Complete pages 1 and 2 and send with a check or money order for the state share of the fee, payable to the Commonwealth of Massachusetts.

Department of Environmental Protection  
 Box 4062  
 Boston, MA 02211

- b.) **To the Conservation Commission:** Send the Notice of Intent or Abbreviated Notice of Intent; a **copy** of this form; and the city/town fee payment.

**To MassDEP Regional Office** (see Instructions): Send a copy of the Notice of Intent or Abbreviated Notice of Intent; a **copy** of this form; and a **copy** of the state fee payment. (E-filers of Notices of Intent may submit these electronically.)



21 Griffin Road North  
Windsor, CT 06095  
860.298.9692

Citizens Bank  
CONNECTICUT  
51-7011/2111

CHECK DATE  
July 19, 2023



PAY Three Hundred Eighty Seven and 50/100 Dollars

AMOUNT

PAY TO THE ORDER OF  
City of Fitchburg  
Conservation Commission  
718 Main Street  
Fitchburg, MA 01420

\$ 387.50

*Michelle Rubino*

BY  
VOID AFTER 90 DAYS

AUTHORIZED SIGNATURE <sup>MP</sup>



21 Griffin Road North  
Windsor, CT 06095  
860.298.9692

ENVIRONMENTAL BUSINESS FORMS 800.392.6018 DELTEK VISION

1260918

Check Date: 7/19/2023

| Invoice Number                  | Date      | Voucher      | Amount | Discounts | Previous Pay | Net Amount |
|---------------------------------|-----------|--------------|--------|-----------|--------------|------------|
| CITY SHARE NOI JL23             | 7/19/2023 | 007758522917 | 387.50 |           |              | 387.50     |
| City of Fitchburg               |           | TOTAL        | 387.50 |           |              | 387.50     |
| Citizen Bank - Disbursement . 2 |           | 130801       |        |           |              |            |



21 Griffin Road North  
Windsor, CT 06095  
860.298.9692

Citizens Bank  
CONNECTICUT  
51-7011/2111

CHECK DATE

July 19, 2023



PAY Three Hundred Sixty Two and 50/100 Dollars

AMOUNT

PAY TO THE ORDER OF  
Commonwealth Of Massachusetts  
Department of Environmental Protection  
P.O. Box 4062  
Boston, MA 02211

\$ 362.50

*Michelle Rubino*

BY  
VOID AFTER 90 DAYS

AUTHORIZED SIGNATURE



21 Griffin Road North  
Windsor, CT 06095  
860.289.9692

EMILY BUSINESS FORMS 800.392.6018 DELIVER VISION

1260920

Check Date: 7/19/2023

| Invoice Number                  | Date      | Voucher      | Amount | Discounts | Previous Pay | Net Amount |
|---------------------------------|-----------|--------------|--------|-----------|--------------|------------|
| STATE SHARE NOI JL23            | 7/19/2023 | 007758522909 | 362.50 |           |              | 362.50     |
| Commonwealth Of Massachusetts   |           | TOTAL        | 362.50 |           |              | 362.50     |
| Citizen Bank - Disbursement - 4 |           | 030812       |        |           |              |            |



---

**ATTACHMENT A – Project Narrative**



## 1.0 INTRODUCTION

TRC Companies (TRC) has prepared this Notice of Intent (NOI) on behalf of the Massachusetts Department of Transportation – Highway Division (MassDOT) for the replacement of an outfall associated with the River Street Bridge Replacement in Fitchburg. The bridge replacement is not considered under this NOI; the bridge replacement qualifies for the bridge exemption under the 2014 Transportation Bond Bill and is exempt from the Wetlands Protection Act. The Project work will take place on River Street roughly between its intersection with Main Street and the Dunkin’ Donuts at 33-37 River Street (Attachment B, Figure 1). This NOI is submitted for compliance with the Massachusetts Wetlands Protection Act (WPA) (M.G.L. Chapter 131, Section 40) and its associated regulations (310 CMR 10.00). As an agency of the Commonwealth providing essential government functions, MassDOT is exempt from certain municipal requirements including but not limited to wetland bylaws, ordinances and policies, and for paying peer review fees. Additionally, MassDOT is not required to notify abutters per the WPA Regulations at 310 CMR 10.05(4).

The Project involves the replacement of the existing twelve-inch stormwater outfall at 0 Main Street with a sixty-inch diameter outfall. This outfall will tie into the City’s proposed CSO 010 Separation/Rehabilitation project. The proposed expansion of the outfall will require temporarily deconstructing a portion of the existing flood wall, installation of a temporary cofferdam on the bank below the wall, and reconstruction of the flood wall around the new outfall.

A summary of the jurisdictional work associated with the Project is outlined in the table below.

| PROPOSED ACTIVITY   | JURISDICTIONAL RESOURCES   |
|---|--|
| <b><i>Activities that are subject to regulation under the WPA</i></b> |  |
| Outfall and flood wall replacement.                                   | <ul style="list-style-type: none"> <li>• Riverfront Area</li> <li>• Bank</li> <li>• Bordering Land Subject to Flooding (BLSF)</li> <li>• 100-ft buffer zone</li> <li>• Land Under Waterbodies and Waterways (LUW)</li> </ul> |





## 2.0 SITE DESCRIPTION AND EXISTING CONDITIONS

The project site (0 Main Street) is located adjacent to the northern end of the River Street Bridge (Bridge F-04-010) in the City of Fitchburg. The surrounding area is a developed urban landscape with mostly disturbed lots and mostly impermeable surfaces. The 0 Main Street property is bordered by River Street, Main Street, and the North Nashua River. The portion of the site bordering Main Street is surfaced with old asphalt, gravel, and weeds. Vegetation (mature trees and underbrush) is present along the river.

An existing 12" drainage outfall extends from a manhole located at the northeastern end of the River Street Bridge to a flood wall located above the bank of the North Nashua River. The outfall drains through an approximately 4sf opening in the existing flood wall, which is composed of cut stone blocks.

There are no Outstanding Resource Waters, Areas of Critical Environmental Concern, Certified Vernal Pools, or Priority or Estimated Habitats of Rare Species within the Site. The monarch butterfly (*Danaus plexippus*, a candidate species for listing), and the endangered northern long-eared bat (*Myotis septentrionalis*) may occur in the project area (IPaC Consultation, Attachment C). Project activities are not anticipated to impact either of these species. Areas that will be temporarily disturbed do not host milkweed plants and are therefore unlikely to provide habitat for monarch butterflies. Additionally, though project activities will involve the removal of a small number of trees, most of these trees are unlikely to provide roosting habitat to northern long eared bats due to their small size. Additionally, project activities will not impact northern long eared bat foraging habitats. TRC and STV are currently in consultation with USACOE over possible additional permitting requirements. See the Attachment B, Figure 2 for aerial imagery of the Project Area and resource areas.

### 2.1 Jurisdictional Resource Areas

Multiple resource areas, as defined in the WPA and described in the following sections, exist within the Project Area. TRC delineated the mean annual high water line (MAHW) of the North Nashua River within the Project Area, on March 10, 2023 as seen in Attachment B, Figure 2. Refer to Section 4 herein for further details about impacts to each resource area associated with the proposed Project.

#### 2.1.1 Riverfront Area

Per 310 CMR 10.58(2)(a)(3), Riverfront Area is “the area of land between a river’s mean annual high-water line measured horizontally outward from the river and a parallel line located 200 feet away.”

Riverfront Area is associated with the North Nashua River. The proposed project includes temporary impacts to the Riverfront Area due to excavation required for the replacement/upgrade of the stormwater outfall, as shown in Attachment B, Figure 2.

#### 2.1.2 Bordering Land Subject to Flooding

Per 310 CMR 10.57(2)(a)(1)&(3) Bordering Land Subject to Flooding (BLSF) is “an area with low, flat topography adjacent to and inundated by flood waters rising from creeks, rivers, streams,



ponds, or lakes. It extends from the banks of these waterways and water bodies; where a bordering vegetated wetland occurs, it extends from said wetland...The boundary of Bordering Land Subject to Flooding is the estimated maximum lateral extent of flood water which will theoretically result from the statistical 100-year frequency storm. Said boundary shall be that determined by reference to the most recently available flood profile data prepared for the community within which the work is proposed under the National Flood Insurance Program.”

BLSF is associated with the 100 year floodplain of the North Nashua River. The proposed project includes temporary impacts to BLSF due to excavation required for the replacement/upgrade of the stormwater outfall, as shown in Attachment B, Figure 2.

### **2.1.3 Bank**

Per 310 CMR 10.54(2)(a), a Bank is *“the portion of the land surface which normally abuts and confines a water body. It occurs between a water body and a vegetated bordering wetland and adjacent flood plain, or, in the absence of these, it occurs between a water body and an upland.”*

Bank exists along the North Nashua River in the project area as shown in Attachment B, Figure 2. Because the river is confined by flood walls in this location, bank was identified as the mean annual high water line at the bottom of the wall. Therefore, TRC is not considering the top of the wall to be bank.

The proposed project includes temporary impacts to Bank due to installation of a temporary cofferdam.

### **2.1.4 Land Under Waterbodies and Waterways**

Per 310 CMR 10.56(2)(a), LUW is *“the land beneath any creek, river, stream, pond or lake. Said land may be composed of organic muck or peat, fine sediments, rocks or bedrock.”*

LUW exists within the North Nashua River in the project area as shown in Attachment B, Figure 2.

The proposed project includes temporary impacts to limited areas of LUW due to the installation of a temporary cofferdam adjacent to the flood wall during outfall replacement/upgrade construction activities.

### **2.1.5 Buffer Zones**

Per 310 CMR 10.02(2)(b), a buffer zone extends 100 feet outward from Bank and BVW (whichever abuts the upland portion of the Site).

Buffer zone associated with Bank exists throughout the project area as shown in Attachment B, Figure 2.

The proposed Project includes impacts to buffer zone Due to excavation required for the replacement/upgrade of the stormwater outfall.



## **3.0 PROPOSED PROJECT DESCRIPTION**

The proposed project will involve the components described in section 3.1 below.

As part of The River Street Bridge Replacement Project, MassDOT will install an upgraded outfall system at 0 Main Street and remove the existing drain system as part of the City of Fitchburg's CSO 010 Separation/Rehabilitation project. A 60" HDPE pipe will be installed in place of the existing 12" pipe running from the 0 Main Street manhole to the North Nashua River. This outfall will pass through the existing flood wall, which will be partially demolished and reconstructed to accommodate the new, larger pipe.

### **3.1 Work Descriptions**

#### ***3.1.1 Erosion and Sedimentation Controls***

Temporary erosion and sedimentation control measures such as silt fence and/or compost filter tubes will be installed prior to the commencement of any site work and will remain in place until all site work is complete and the site is stable. Accumulated materials will be removed from behind erosion and sedimentation control measures as necessary, and measures found to need repair or replacement will be immediately corrected. Areas that will remain exposed or undisturbed for fourteen days or longer will be stabilized with mulch or seeded for temporary vegetative cover. Sediment and erosion controls will be inspected at least once every 7 calendar days and after a rain event resulting in 0.25 inches or more of rainfall. Any additional sedimentation control efforts determined to be necessary will be implemented immediately. Erosion and sedimentation control systems (and all accumulated sediments) will be removed when no longer required. Erosion and sediment control details are included in Attachment B.

#### ***3.1.2 Temporary Cofferdam***

An approximately 30 ft long temporary cofferdam will be installed parallel to the bank of the North Nashua River prior to construction activities. This cofferdam will be placed adjacent to the existing flood wall, which is approximately 25 ft in length. The flood wall will be partially demolished and reconstructed to install the new outfall. Accumulated materials will be removed as necessary, and any part of the cofferdam found to need repair or replacement will be immediately corrected. Cofferdam details are included in Attachment B.

#### ***3.1.3 Brush Clearing and Site Preparation***

Clearing and grubbing of existing brush and trees will occur within the proposed limits of work to facilitate access to the Site and provide a safe work area for project personnel.

#### ***3.1.4 Equipment Access***

The project will avoid and minimize resource area impacts to the extent practicable by using existing upland areas for initial staging of equipment and materials. A portion of the site closest to the River Street Bridge will be temporarily graded and restored to existing pre-construction grades. Prior to construction work an existing chain link fence will also be removed from the site.



---

### ***3.1.5 New Sewer Outfall and Partial Demolition /Reconstruction of Flood Wall***

MassDOT will install an upgraded outfall system at 0 Main Street and remove the existing drain system. The new outfall will connect to an 8' diameter manhole located in the River Street roadway (installed by the City as part of the CSO 010 Separation/Rehabilitation project). A 60" HDPE pipe will be installed to connect the River Street manhole with a new 8' diameter manhole located on the 0 Main Street property. A second 60" diameter HDPE pipe will be installed, running from the 0 Main Street manhole to the North Nashua River. This outfall will pass through the existing flood wall, which will be partially demolished and reconstructed to accommodate the new, larger pipe. Outfall construction is anticipated to occur before bridge superstructure replacement. Following outfall installation, the embankment in front of the reconstructed flood wall will be restored. These construction activities will require excavation within Riverfront Area and Buffer Zone. Additionally, a portion of the existing flood wall will be demolished and reconstructed to allow for installation of the new 60" HDPE sewer outfall next to the existing drain.

### ***3.1.6 Removal of Existing Drainage Outfall***

The existing drainage outfall will be maintained until the proposed new outfall is in service, at which time the old outfall will be removed.



## 4.0 IMPACTS, PERFORMANCE STANDARDS, AND MITIGATION MEASURES

The proposed Project will result in temporary impacts to jurisdictional resource areas as described in the following table:

| Work Action         | Temporary Resource Area Impacts |      |                 |      |      |      |      |      |       |      |
|---------------------|---------------------------------|------|-----------------|------|------|------|------|------|-------|------|
|                     | Buffer Zone<br>(100-ft of Bank) |      | Riverfront Area |      | Bank |      | LUW  |      | BLSF  |      |
|                     | (SF)                            | (LF) | (SF)            | (LF) | (SF) | (LF) | (SF) | (LF) | (SF)  | (LF) |
| Outfall Replacement | 1,341                           | None | 1,341           | None | None | 37   | 150  | None | 1,341 | None |

The proposed temporary impacts to Buffer Zone, Riverfront Area, and BLSF are related to the excavation and backfill of the area around the culvert replacement. The proposed temporary impacts to Bank and LUW are related to the installation of a temporary cofferdam under the flood wall in the culvert replacement area. The Project complies with performance standards for each resource area to the maximum extent practicable. The following sections address performance standards for proposed impacts due to the sewer outfall replacement during the River Street Bridge replacement project within the resources.

### 4.1 Best Management Practices

Due to the nature of the work, some disturbance to the regulated Riverfront Area, Bank, LUW, BLSF, and Buffer Zone is unavoidable. However, project construction approaches have been selected to minimize disturbance to the Riverfront Area and buffer zones, while allowing construction vehicles access to the required locations for the Project. Although work will occur in a regulated area, BMPs will be utilized and temporarily disturbed areas will be restored after the sewer outfall replacement is complete. Proposed BMPs and mitigation measures are discussed further below.

The work is expected to meet the performance standards associated with protected resource areas while working in Riverfront Area, Bank, LUW, BLSF and buffer zone. BMPs that will be implemented include:

- avoiding permanent disturbance to regulated resources;
- using erosion controls where an erosion hazard exists;
- restoring altered areas to pre-construction conditions

### 4.2 Riverfront Area

Proposed impacts to the riverfront area include the redevelopment of a previously developed area, including the improvement of an existing drainage outfall according to 310 CMR 10.58(5). About 1,341 SF (approximately 0.03 acres) of Riverfront Area will be temporarily impacted by



project activities. The proposed work complies to the maximum extent practicable with the WPA performance standards for redevelopment of riverfront area as described in the following table:

| PERFORMANCE STANDARDS 310 CMR 10.58(5)   | PROJECT'S COMPLIANCE WITH PERFORMANCE STANDARD   |
|--|--|
| <p>(a) At a minimum, proposed work shall result in an improvement over existing conditions of the capacity of the riverfront area to protect the interests identified in M.G.L. c. 131 § 40. When a lot is previously developed but no portion of the riverfront area is degraded, the requirements of 310 CMR 10.58(4) shall be met.</p>  | <p>The existing drainage outfall at 0 Main Street will be replaced with an upgraded outfall connected to an updated system constructed by the City of Fitchburg (CSO 101 project). This replacement will improve the drainage and erosion in resource areas with regard to stormwater runoff. The area excavated to replace this outfall will be restored to pre-disturbance conditions.</p> |
| <p>(b) Stormwater management is provided according to standards established by the Department.</p>   | <p>Please see Attachment E.</p>  |
| <p>(c) Within 200-foot riverfront areas, proposed work shall not be located closer to the river than existing conditions or 100 feet, whichever is less.</p>   | <p>No proposed improvements will be located closer to the riverfront than existing structures (the flood wall to be partially demolished and reconstructed is already present at the site).</p>  |
| <p>(d) Proposed work, including expansion of existing structures, shall be located outside the riverfront area or toward the riverfront area boundary and away from the river, except in accordance with 310 CMR 10.58(5)(f) or (g).</p>   | <p>Proposed work will be in accordance with 310 CMR 10.58(5)(f) to the maximum extent practicable by reducing runoff and improving the stormwater system.</p>  |
| <p>(e) The area of proposed work shall not exceed the amount of degraded area, provided that the proposed work may alter up to 10% if the degraded area is less than 10% of the riverfront area, except in accordance with 310 CMR 10.58(5)(f) or (g).</p>   | <p>The proposed work is taking place within an area that is considered degraded riverfront area. The sewer outfall improvements will reduce stormwater erosion in this area.</p>   |
| <p>(f) When an applicant proposes restoration on-site of degraded riverfront area, alteration may be allowed notwithstanding the criteria of 310 CMR 10.58(5)(c), (d), and (e) at a ratio in square feet of at least 1:1 of restored area to area of alteration not conforming to the criteria. Areas immediately along the river shall be selected for restoration. Alteration not conforming to the criteria shall begin at the riverfront area boundary. Restoration shall include:</p> <ol style="list-style-type: none"> <li>1. removal of all debris, but retaining any trees or other mature vegetation;</li> <li>2. grading to a topography which reduces runoff and increases infiltration;</li> <li>3. coverage by topsoil at a depth consistent with natural conditions at the site; and</li> <li>4. seeding and planting with an erosion control seed mixture, followed by plantings of</li> </ol> | <p>The area will be restored to preexisting conditions.</p>  |



| PERFORMANCE STANDARDS 310 CMR 10.58(5)                   | PROJECT'S COMPLIANCE WITH PERFORMANCE STANDARD |
|--|--|
| herbaceous and woody species appropriate to the site;    |  |
| <i>Performance Standards g and h are not applicable.</i> |  |

**4.3 Bank**

Proposed impacts to Bank include temporary disturbance of approximately 30 ft abutting the North Nashua River due to installation of a temporary cofferdam. The proposed work complies to the maximum extent practicable with the WPA general performance standards for work in Bank described in 310 CMR 10.54(4) as described in the following table:

| PERFORMANCE STANDARDS 310 CMR 10.54(4)  | PROJECT'S COMPLIANCE WITH PERFORMANCE STANDARD  |
|---|---|
| <p>(a) Where the presumption set forth in 310 CMR 10.54(3) is not overcome, any proposed work on a Bank shall not impair the following:</p> <ol style="list-style-type: none"> <li>1. the physical stability of the Bank;</li> <li>2. the water carrying capacity of the existing channel within the Bank;</li> <li>3. ground water and surface water quality;</li> <li>4. the capacity of the Bank to provide breeding habitat, escape cover and food for fisheries;</li> <li>5. the capacity of the Bank to provide important wildlife habitat functions.</li> </ol>  | <p>The proposed work on the bank will not impair the physical stability of the bank. The installation of a temporary cofferdam will not impact physical stabilization of the bank nor will it impact the carrying capacity of the North Nashua River or groundwater quality. Surface water quality will not be impacted by work on the bank, as erosion and sedimentation control measures will be implemented during construction activities and in fact, the purpose of the cofferdam is to keep debris out of the surface water. As the area of bank impacted by project activities is small, no impacts to fisheries or wildlife habitat functions are anticipated.</p> |
| <i>Performance standard a6 is not applicable</i>  |   |
| <p>(b) Notwithstanding the provisions of 310 CMR 10.54(4)(a), structures may be permitted in or on a Bank when required to prevent flood damage to facilities, buildings and roads constructed prior to the effective date of 310 CMR 10.51 through 10.60 or constructed pursuant to a Notice of Intent filed prior to the effective date of 310 CMR 10.51 through 10.60 (April 1, 1983), including the renovation or reconstruction (but not substantial enlargement) of such facilities, buildings and roads, provided that the following requirements are met:</p> <ol style="list-style-type: none"> <li>1. The proposed protective structure, renovation or reconstruction is designed and constructed using best practical measures so as to minimize adverse effects on the characteristics and functions of the resource area;</li> <li>2. The applicant demonstrates that there</li> </ol> | <p>The proposed sewer outfall replacement, which requires work in the Bank, will improve drainage in the area. BMPs will be employed to minimize adverse effects to Bank and other resource areas. Work in the Bank is required to install the improved sewer outfall.</p>  |



| PERFORMANCE STANDARDS 310 CMR 10.54(4)  | PROJECT'S COMPLIANCE WITH PERFORMANCE STANDARD                                     |
|---|--|
| is no reasonable method of protecting, renovating or rebuilding the facility in question other than the one proposed.   |  |
| (c) Notwithstanding the provisions of 310 CMR 10.54(4)(a) or (b), no project may be permitted which will have any adverse effect on specified habitat sites of Rare Species, as identified by procedures established under 310 CMR 10.59. | The proposed project is not located within specified habitat for any rare species. |

#### 4.4 LUW

Proposed impacts to LUW include temporary disturbance due to placement of a cofferdam (150 SF) and is calculated as the area of the cofferdam itself as well as the dewatered area inside the cofferdam. The proposed work complies to the maximum extent practicable with the WPA general performance standards for work in LUW described in 310 CMR 10.56(4) as described in the following table:

| PERFORMANCE STANDARDS 310 CMR 10.56(4)   | PROJECT'S COMPLIANCE WITH PERFORMANCE STANDARD  |
|--|---|
| <p>(a) Where the presumption set forth in 310 CMR 10.56(3) is not overcome, any proposed work within Land under Water Bodies and Waterways shall not impair the following:</p> <ol style="list-style-type: none"> <li>1. The water carrying capacity within the defined channel, which is provided by said land in conjunction with the banks;</li> <li>2. Ground and surface water quality;</li> <li>3. The capacity of said land to provide breeding habitat, escape cover and food for fisheries; and</li> <li>4. The capacity of said land to provide important wildlife habitat functions.</li> </ol> | <p>Temporary disturbances to LUW due to the placement of a cofferdam will not impair the carrying capacity of the North Nashua River or impact groundwater quality. Surface water quality in the immediate vicinity of disturbed river bottom areas may be temporarily impacted due to localized increased suspended sediment and turbidity during placement and removal, but the purpose of the cofferdam is to protect surface water during construction. However, any impacts are expected to be minor and temporary; suspended sediments are expected to rapidly resettle, and any localized water quality changes will be quickly diluted due to river currents. As the area of LUW impacted by project activities is small, no impacts to fish and wildlife habitat or habitat functions are anticipated.</p> |
| <i>Performance Standard a5 and b are not applicable</i>  |   |
| (c) Notwithstanding the provisions of 310 CMR 10.56(4)(a) or (b), no project may be permitted which will have any adverse effect on specified habitat sites of rare vertebrate or invertebrate species, as identified by procedures established under 310 CMR 10.59.   | The proposed project is not located within specified habitat for any rare vertebrate or invertebrate species.   |





**4.5 BLSF**

Proposed impacts to BLSF include 1,341 SF (about 0.03 acres) of temporary alteration due to replacement of the sewer outfall and partial demolition and reconstruction of the flood wall. The entire area will be restored to preexisting conditions and no change in comp storage is anticipated. The proposed work complies to the maximum extent practicable with the WPA general performance standards for work in BLSF described in 310 CMR 10.57(4) as described in the following table:

| PERFORMANCE STANDARDS 310 CMR 10.57(4)  | PROJECT'S COMPLIANCE WITH PERFORMANCE STANDARD  |
|---|---|
| <p>(a) Bordering Land Subject to Flooding.</p> <p>1. Compensatory storage shall be provided for all flood storage volume that will be lost as the result of a proposed project within Bordering Land Subject to Flooding, when in the judgment of the issuing authority said loss will cause an increase or will contribute incrementally to an increase in the horizontal extent and level of flood waters during peak flows. Compensatory storage shall mean a volume not previously used for flood storage and shall be incrementally equal to the theoretical volume of flood water at each elevation, up to and including the 100-year flood elevation, which would be displaced by the proposed project. Such compensatory volume shall have an unrestricted hydraulic connection to the same waterway or water body. Further, with respect to waterways, such compensatory volume shall be provided within the same reach of the river, stream or creek.</p> <p>2. Work within Bordering Land Subject to Flooding, including that work required to provide the above-specified compensatory storage, shall not restrict flows so as to cause an increase in flood stage or velocity.</p> <p>3. Work in those portions of bordering land subject to flooding found to be significant to the protection of wildlife habitat shall not impair its capacity to provide important wildlife habitat functions. Except for work which would adversely affect vernal pool habitat, a project or projects on a single lot, for which Notice(s) of Intent is filed on or after November 1, 1987, that (cumulatively) alter(s) up to 10% or 5,000 square feet (whichever is less) of land in this resource area found to be significant to the protection of wildlife habitat, shall not be deemed to impair its capacity to provide important wildlife</p> | <p>No flood storage volume within BLSF will be lost as a result of the proposed project. The project includes minimal grading within BLSF which will be restored to preexisting conditions. No change in comp storage is anticipated.</p> <p>The temporary cofferdam will occupy approximately 60 sf of area within the North Nashua River. However, the presence of the cofferdam will not restrict flows so as to cause an increase in flood stage or velocity.</p> <p>The proposed project will not result in alterations of BLSF in areas significant to the protection of wildlife habitat or in vernal pool habitat (Attachment C).</p> |



| PERFORMANCE STANDARDS 310 CMR 10.57(4)   | PROJECT'S COMPLIANCE WITH PERFORMANCE STANDARD   |
|--|--|
| habitat functions. Additional alterations beyond the above threshold, or altering vernal pool habitat, may be permitted if they will have no adverse effects on wildlife habitat, as determined by procedures contained in 310 CMR 10.60.  |  |
| <i>Performance Standard b is not applicable</i>  |  |
| (c) Protection of Rare Wildlife Species. Notwithstanding the provisions of 310 CMR 10.57(4)(a) or (b), no project may be permitted which will have any adverse effect on specified wildlife habitat sites of rare vertebrate or invertebrate species, as identified by procedures established under 310 CMR 10.59. | The proposed project is not located within specified habitat for any rare vertebrate or invertebrate species (Attachment C). |

#### 4.6 Buffer Zone

While the WPA recognizes the importance of the buffer zone, it does not include specific performance standards. Proposed work within the buffer zone includes about 1,341 SF (about 0.03 acres) of alteration due to replacement of the new sewer outfall and partial demolition and reconstruction of the flood wall. Impacts to the buffer zone have been minimized to the maximum extent practicable.

#### 4.7 Stormwater Management

BMPs will be used, as described earlier in Section 4.1, to control erosion and sedimentation during the proposed work. In addition, a stormwater Report can be found in Attachment E. There is no anticipated increase in impervious surface associated with this work. The attached stormwater report is for the entire city of Fitchburg stormwater project and is provided for informational purposes only. The attached stormwater report is not specific to this outfall.



---

## ATTACHMENT B – Figures & Plans

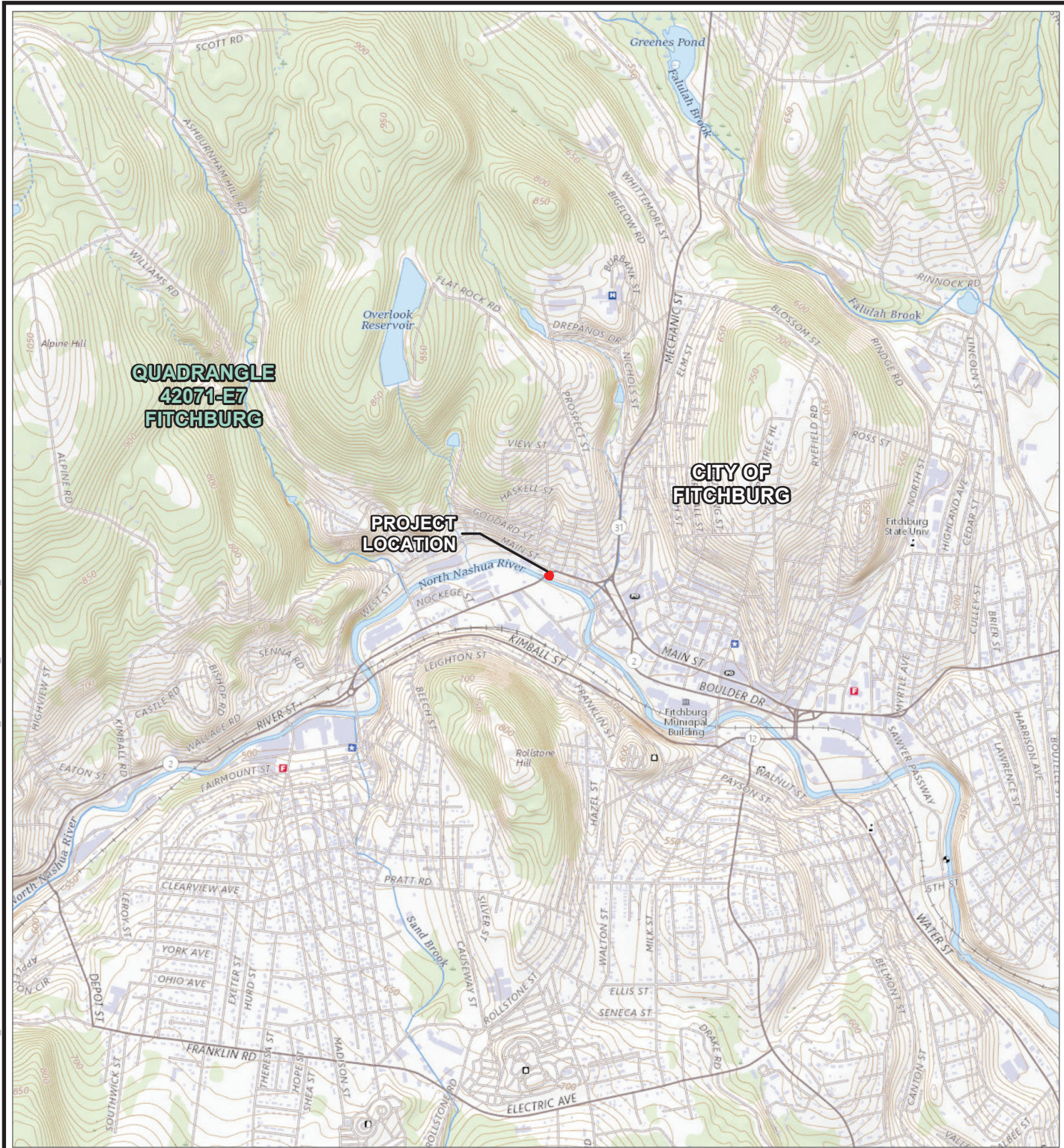

COORDINATE SYSTEM: NAD 1983 STATEPLANE MASSACHUSETTS MAINLAND FIPS 2001; MAP ROTATION: 0  
 - SAVED BY: SMOTURI ON 6/28/2023, 12:06:44 PM. FILE PATH: T:\1-PROJECTS\STV\502516\_FITCHBURG\2-APPX\FITCHBURG.APRX; LAYOUT NAME: FIG1\_FITCHBURG\_SITELLOCATION\_8.6X11P

LIMIT OF WORK

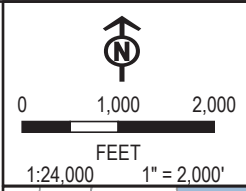

BASE MAP: ESRI "USGS TOPO" SERVICE  
 DATA SOURCES: TRC

|              |             |  |        |
|--------------|-------------|--|--------|
| PROJECT:     |             | <b>STV INC</b>   |        |
|              |             | <b>RIVER STREET (BRIDGE NO. F-04-010)</b>                                  |        |
|              |             | <b>FITCHBURG, MA</b>   |        |
| TITLE:       |             | <b>USGS LOCUS</b>  |        |
| DRAWN BY:    | S. MOTURI   | PROJ. NO.:   | 502516 |
| CHECKED BY:  | M. BILLINGS | <b>FIGURE 1</b>  |        |
| APPROVED BY: | G. RUSSO    |  |        |
| DATE:        | JUNE 2023   |  |        |
|              |             | 650 SUFFOLK STREET<br>SUITE 200<br>LOWELL, MA 01854<br>PHONE: 978.970.5600 |        |
| FILE:        |             | FITCHBURG  |        |

- LIMIT OF WORK
- CULVERT REPLACEMENT AREA
- CULVERT
- STREAM PLOT
- STREAM FLAG
- DELINEATED PERENNIAL STREAM BANK
- 100-FT BUFFER ZONE
- 200-FT RIVERFRONT AREA
- SPECIAL FLOOD HAZARD AREA (1-PERCENT ANNUAL CHANCE FLOOD OR 100-YEAR FLOOD - FEMA)
- BASE MAP: MASSGIS 2021 ORTHO PHOTOS.
- DATA SOURCES: TRC



|   |             |  |         |
|---|-------------|--|---------|
| PROJECT:  |             | STV INC<br>RIVER STREET (BRIDGE NO. F-04-010)<br>FITCHBURG, MA |         |
| TITLE:  |             | DELINEATION MAP  |         |
| DRAWN BY:   | S. MOTURI   | PROJ. NO.:   | 5102516 |
| CHECKED BY:   | M. BILLINGS |  |         |
| APPROVED BY:  | G. RIGGIO   |  |         |
| DATE:   | JUNE 2023   |  |         |
|   |             | FIGURE 2   |         |
| 650 SUFFOLK STREET<br>LOWELL, MA 01854<br>PHONE: 978.970.5800 |             |  |         |
|   |             |  |         |
| F. FILE: Fitchburg.dwg  |             |  |         |



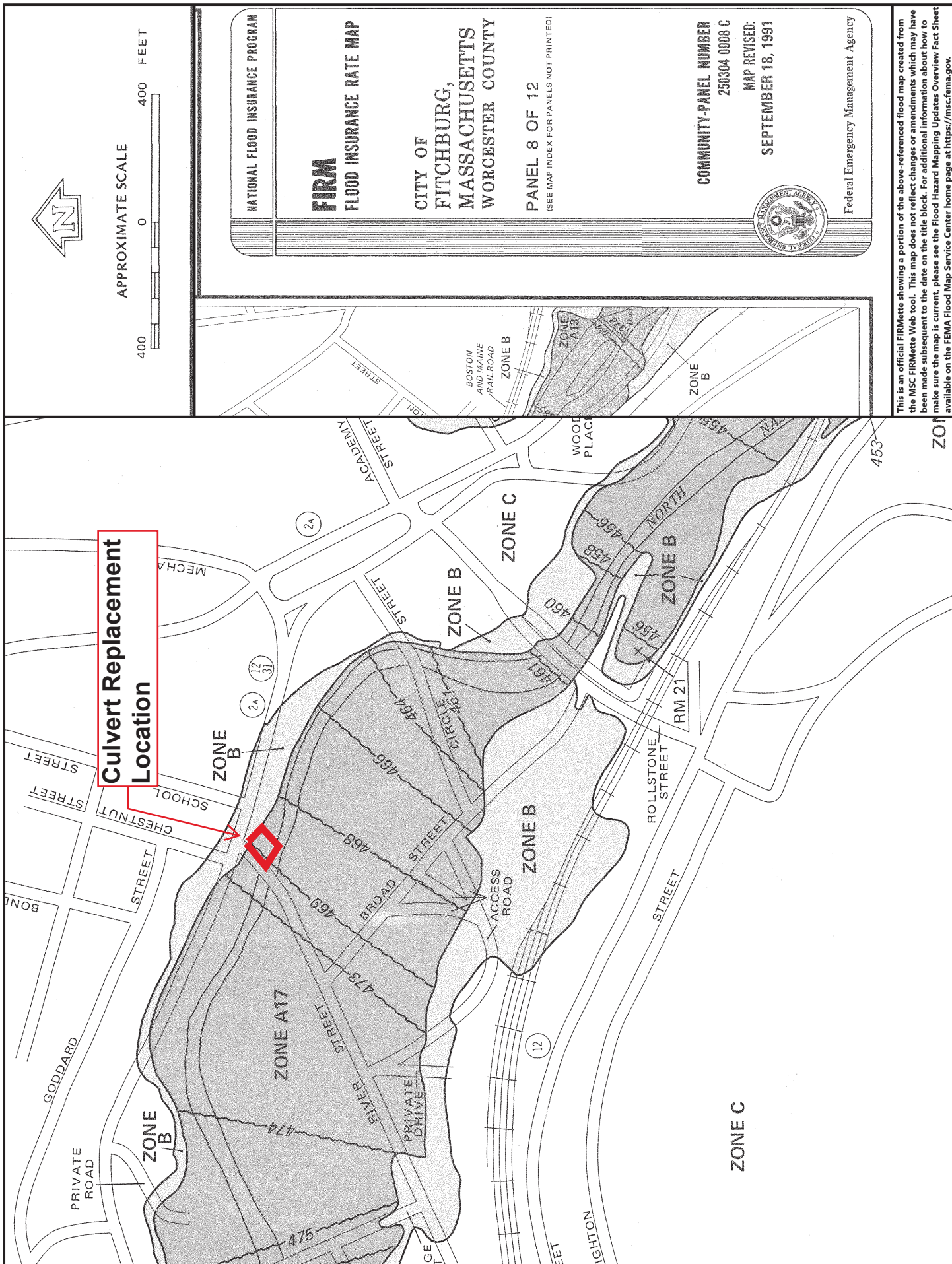

**Culvert Replacement Location**

NATIONAL FLOOD INSURANCE PROGRAM

**FIRM**  
FLOOD INSURANCE RATE MAP

CITY OF  
FITCHBURG,  
MASSACHUSETTS  
WORCESTER COUNTY

PANEL 8 OF 12  
(SEE MAP INDEX FOR PANELS NOT PRINTED)

COMMUNITY-PANEL NUMBER  
250304 0008 C

MAP REVISED:  
SEPTEMBER 18, 1991

FEDERAL EMERGENCY MANAGEMENT AGENCY

This is an official FIRMette showing a portion of the above-referenced flood map created from the MSC FIRMette Web tool. This map does not reflect changes or amendments which may have been made subsequent to the date on the title block. For additional information about how to make sure the map is current, please see the Flood Hazard Mapping Updates Overview Fact Sheet available on the FEMA Flood Map Service Center home page at <https://msc.fema.gov>.

# MASSACHUSETTS DEPARTMENT OF TRANSPORTATION HIGHWAY DIVISION

PLAN AND PROFILE OF  
RIVER STREET  
(BRIDGE NO. F-04-010)  
IN THE CITY OF  
FITCHBURG  
WORCESTER COUNTY

|                                    |        |
|------------------------------------|--------|
| FITCHBURG<br>RIVER STREET/ROUTE 31 |        |
| STATE                              | MA     |
| REG. APPROX. NO.                   | 1      |
| PROJECT FILE NO.                   | 607680 |
| NO.                                | 1      |
| SHEET                              | 08     |

TITLE SHEET & INDEX

THESE PLANS ARE SUPERSEDED BY THE 2005 STANDARD SPECIFICATIONS, THE LATEST SUPPLEMENTAL SPECIFICATIONS, THE OCTOBER 2017 CONSTRUCTION STANDARD DETAILS, THE 2015 OVERHEAD SIGNAL STRUCTURE AND FOUNDATION STANDARD DRAWINGS, MASSDOT TRAFFIC MANAGEMENT PLANS AND DETAIL DRAWINGS, THE 1900 STANDARD DRAWINGS FOR SIGNS AND SUPPORTS, THE 1908 STANDARD DRAWINGS FOR TRAFFIC SIGNALS AND HIGHWAY LIGHTING, AND THE LATEST EDITION OF THE AMERICAN STANDARD FOR NURSERY STOCK.

**DESIGN DESIGNATION (RIVER STREET/RT 31)**

|                           |                          |
|---------------------------|--------------------------|
| DESIGN SPEED              | 25 MPH                   |
| ADT (2025)                | 12,302                   |
| ADT (2045)                | 15,010                   |
| K                         | 8.7%                     |
| D                         | 58%                      |
| T (PEAK HOUR)             | 6.97%                    |
| T (AVERAGE DAY)           | 5.15%                    |
| DDV                       | 1943                     |
| DDV                       | 721                      |
| FUNCTIONAL CLASSIFICATION | Urban Principal Arterial |

Designed By  
**STV** Incorporated  
One Financial Center  
Boston, MA 02111  
T: 617.482.7289  
F: 617.482.1837

WITH CONSULTANT:  
**C&C**  
CONSULTING ENGINEERS, LLC  
214 Lincoln St  
Boston, MA 02134  
T: 617.254.6930  
F: 617.254.7631

## PS&E SUBMITTAL

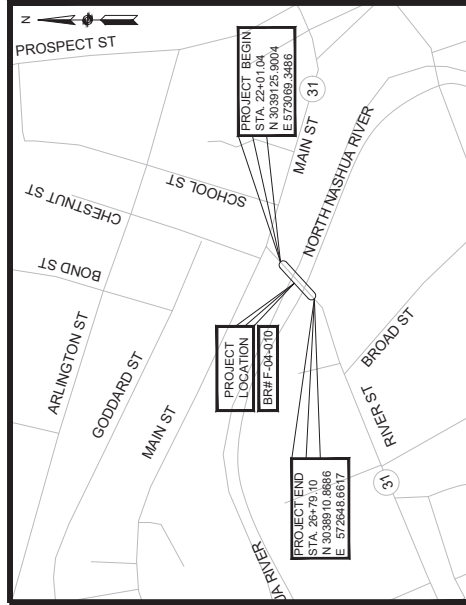

0 200 400 600  
SCALE: 1" = 200'  
LENGTH OF PROJECT = 480 FEET = 0.09 MILES

**INDEX**

| SHEET NO. | DESCRIPTION  |
|-----------|--|
| 1         | TITLE SHEET & INDEX                                  |
| 2         | LEGEND & ABBREVIATIONS                               |
| 3         | GENERAL NOTES  |
| 4         | KEY PLAN & BORING PLAN                               |
| 5         | TYPICAL SECTIONS & PAVEMENT NOTES                    |
| 6         | SURVEY CONTROL & CONSTRUCTION BASELINE TIES          |
| 7         | CONSTRUCTION PLANS                                   |
| 8         | PROFILE  |
| 9         | CURB TIE PLANS                                       |
| 10        | GRADING PLANS  |
| 11        | DRAINAGE & UTILITY PLANS                             |
| 12        | DRAINAGE & UTILITY DETAILS 1 OF 2                    |
| 13        | DRAINAGE & UTILITY DETAILS 2 OF 2                    |
| 14        | TRAFFIC SIGNS & PAVEMENT MARKINGS                    |
| 15        | TRAFFIC SIGN SUMMARY SHEET                           |
| 16        | TEMPORARY TRAFFIC CONTROL PLAN GENERAL NOTES         |
| 17        | TEMPORARY TRAFFIC CONTROL PLANS - PHASE 1A & 1B      |
| 18        | TEMPORARY TRAFFIC CONTROL PLANS - PHASE 2A & 2B      |
| 19        | TEMPORARY TRAFFIC CONTROL PLANS - TYPICAL DETAILS    |
| 20        | TEMPORARY TRAFFIC CONTROL PLANS - TRAFFIC DETOUR     |
| 21        | TEMPORARY TRAFFIC CONTROL PLANS - SIGN SUMMARY TABLE |
| 22        | CONSTRUCTION DETAILS                                 |
| 23        | PEDESTRIAN CURB RAMP & DRIVEWAY DETAILS 1 OF 2       |
| 24        | PEDESTRIAN CURB RAMP & DRIVEWAY DETAILS 2 OF 2       |
| 25-62     | CROSS SECTIONS                                       |
| 63-68     |  |

|            |                |       |
|------------|----------------|-------|
| 07/20/2023 | PS&E SUBMITTAL | 1     |
| 08/09/2023 | PS&E SUBMITTAL |       |
| 08/10/2023 | 100% SUBMITTAL |       |
| 08/02/2022 | 75% SUBMITTAL  |       |
| 08/18/2020 | 25% SUBMITTAL  |       |
| DATE       | DESCRIPTION    | REV # |



APPROVED  
\_\_\_\_\_  
CHIEF ENGINEER  
DATE

| GENERAL SYMBOLS |          | TRAFFIC SYMBOLS |          | ABBREVIATIONS |                                 | ABBREVIATIONS (cont.) |                                 |
|-----------------|----------|-----------------|----------|---------------|---------------------------------|-----------------------|---------------------------------|
| EXISTING        | PROPOSED | EXISTING        | PROPOSED | GENERAL       | TRAFFIC                         | GENERAL               | TRAFFIC                         |
|                 |          |                 |          | ADOT          | ANNUAL AVERAGE DAILY TRAFFIC    | ADOT                  | ANNUAL AVERAGE DAILY TRAFFIC    |
|                 |          |                 |          | ADJ           | ADJUSTMENT                      | ADJ                   | ADJUSTMENT                      |
|                 |          |                 |          | ADU           | ADDITIONAL                      | ADU                   | ADDITIONAL                      |
|                 |          |                 |          | ADP           | APPROACH                        | ADP                   | APPROACH                        |
|                 |          |                 |          | APPR          | APPROXIMATE                     | APPR                  | APPROXIMATE                     |
|                 |          |                 |          | ASPH          | ASPHALT CONCRETE                | ASPH                  | ASPHALT CONCRETE                |
|                 |          |                 |          | ASPH          | ASPHALTED CORRUGATED METAL PIPE | ASPH                  | ASPHALTED CORRUGATED METAL PIPE |
|                 |          |                 |          | BT            | BITUMINOUS                      | BT                    | BITUMINOUS                      |
|                 |          |                 |          | BO            | BOTTOM OF CURB                  | BO                    | BOTTOM OF CURB                  |
|                 |          |                 |          | BL            | BOUND                           | BL                    | BOUND                           |
|                 |          |                 |          | BLD           | BUILDING                        | BLD                   | BUILDING                        |
|                 |          |                 |          | BLM           | BASELINE                        | BLM                   | BASELINE                        |
|                 |          |                 |          | BM            | BENCHMARK                       | BM                    | BENCHMARK                       |
|                 |          |                 |          | BO            | BY OTHERS                       | BO                    | BY OTHERS                       |
|                 |          |                 |          | BOS           | BOTTOM OF SLOPE                 | BOS                   | BOTTOM OF SLOPE                 |
|                 |          |                 |          | BR            | BRIDGE                          | BR                    | BRIDGE                          |
|                 |          |                 |          | BS            | BUSH                            | BS                    | BUSH                            |
|                 |          |                 |          | BS            | BUSH                            | BS                    | BUSH                            |
|                 |          |                 |          | BOT           | BOTTOM OF WALL                  | BOT                   | BOTTOM OF WALL                  |
|                 |          |                 |          | BR            | BRIDGE                          | BR                    | BRIDGE                          |
|                 |          |                 |          | BS            | BUSH                            | BS                    | BUSH                            |
|                 |          |                 |          | BS            | BUSH                            | BS                    | BUSH                            |
|                 |          |                 |          | BS            | BUSH                            | BS                    | BUSH                            |
|                 |          |                 |          | BS            | BUSH                            | BS                    | BUSH                            |
|                 |          |                 |          | BS            | BUSH                            | BS                    | BUSH                            |
|                 |          |                 |          | BS            | BUSH                            | BS                    | BUSH                            |
|                 |          |                 |          | BS            | BUSH                            | BS                    | BUSH                            |
|                 |          |                 |          | BS            | BUSH                            | BS                    | BUSH                            |
|                 |          |                 |          | BS            | BUSH                            | BS                    | BUSH                            |
|                 |          |                 |          | BS            | BUSH                            | BS                    | BUSH                            |
|                 |          |                 |          | BS            | BUSH                            | BS                    | BUSH                            |
|                 |          |                 |          | BS            | BUSH                            | BS                    | BUSH                            |
|                 |          |                 |          | BS            | BUSH                            | BS                    | BUSH                            |
|                 |          |                 |          | BS            | BUSH                            | BS                    | BUSH                            |
|                 |          |                 |          | BS            | BUSH                            | BS                    | BUSH                            |
|                 |          |                 |          | BS            | BUSH                            | BS                    | BUSH                            |
|                 |          |                 |          | BS            | BUSH                            | BS                    | BUSH                            |
|                 |          |                 |          | BS            | BUSH                            | BS                    | BUSH                            |
|                 |          |                 |          | BS            | BUSH                            | BS                    | BUSH                            |
|                 |          |                 |          | BS            | BUSH                            | BS                    | BUSH                            |
|                 |          |                 |          | BS            | BUSH                            | BS                    | BUSH                            |
|                 |          |                 |          | BS            | BUSH                            | BS                    | BUSH                            |
|                 |          |                 |          | BS            | BUSH                            | BS                    | BUSH                            |
|                 |          |                 |          | BS            | BUSH                            | BS                    | BUSH                            |
|                 |          |                 |          | BS            | BUSH                            | BS                    | BUSH                            |
|                 |          |                 |          | BS            | BUSH                            | BS                    | BUSH                            |
|                 |          |                 |          | BS            | BUSH                            | BS                    | BUSH                            |
|                 |          |                 |          | BS            | BUSH                            | BS                    | BUSH                            |
|                 |          |                 |          | BS            | BUSH                            | BS                    | BUSH                            |
|                 |          |                 |          | BS            | BUSH                            | BS                    | BUSH                            |
|                 |          |                 |          | BS            | BUSH                            | BS                    | BUSH                            |
|                 |          |                 |          | BS            | BUSH                            | BS                    | BUSH                            |
|                 |          |                 |          | BS            | BUSH                            | BS                    | BUSH                            |
|                 |          |                 |          | BS            | BUSH                            | BS                    | BUSH                            |
|                 |          |                 |          | BS            | BUSH                            | BS                    | BUSH                            |
|                 |          |                 |          | BS            | BUSH                            | BS                    | BUSH                            |
|                 |          |                 |          | BS            | BUSH                            | BS                    | BUSH                            |
|                 |          |                 |          | BS            | BUSH                            | BS                    | BUSH                            |
|                 |          |                 |          | BS            | BUSH                            | BS                    | BUSH                            |
|                 |          |                 |          | BS            | BUSH                            | BS                    | BUSH                            |
|                 |          |                 |          | BS            | BUSH                            | BS                    | BUSH                            |
|                 |          |                 |          | BS            | BUSH                            | BS                    | BUSH                            |
|                 |          |                 |          | BS            | BUSH                            | BS                    | BUSH                            |
|                 |          |                 |          | BS            | BUSH                            | BS                    | BUSH                            |
|                 |          |                 |          | BS            | BUSH                            | BS                    | BUSH                            |



|  |                    |               |              |
|--|--------------------|---------------|--------------|
| <b>FITCHBURG<br/>RIVER STREET/ROUTE 31</b> |                    |               |              |
| STATE                                      | FED. AID PROJ. NO. | SHEET NO.     | TOTAL SHEETS |
| MA   | -                  | 3             | 08           |
| PROJECT FILE NO. 60790                     |                    | GENERAL NOTES |              |

DAMAGE SUFFERED DURING CONSTRUCTION SHALL BE REPAIRED AT THE CONTRACTORS EXPENSE.

**GENERAL NOTES**

1. THE EXISTING CONDITIONS SHOWN HEREON ARE THE RESULTS OF ANON THE GROUND INSTRUMENT SURVEY PERFORMED ON JUNE 9, 2017 AND OCTOBER 12, 2017 BY C&C CONSULTING ENGINEERS, LLC MASSDOT FIELD BOOK NUMBER 41300. US FEET UNITS USED.
2. HORIZONTAL DATUM IS BASED UPON THE NORTH AMERICAN DATUM OF 1983 (NAD-1983).
3. VERTICAL DATUM IS BASED UPON THE NORTH AMERICAN VERTICAL DATUM OF 1988 (NAVZ-1988).
4. THE SURVEY REFERENCES ARE AS FOLLOWS:  
 MASSDOT LAYOUT DEC. 18, 1951, NO. 3817 RIVER STREET, PLK BK 91 PG 22  
 MASS DOT DEPT. OF PUBLIC WORKS, PLAN DATED JANUARY 22, 1952  
 RECORD BASELINE IS FROM PLAN OF ROAD IN CITY OF FITCHBURG IN WORCESTER COUNTY LAD AS A STATE HIGHWAY LAYOUT BY THE DEPARTMENT OF PUBLIC WORKS DATED DECEMBER 18, 1951 WITH SCALE 20 FEET TO THE INCH AND RECORDED IN WORCESTER NORTHERN DISTRICT, REGISTRY OF DEEDS IN PLAN BOOK 91, PAGE 22. THE PLAN SHOWS LOCATION OF SILENO, 1951 FROM STATION 22+75.300 TO STATION 23+46.00.

5. THE LOCATION OF THE UTILITIES SHOWN HEREON HAVE BEEN COMPILED FROM VISIBLE STRUCTURES AND INFORMATION OBTAINED FROM VARIOUS SOURCES. THE ACTUAL LOCATION OF UTILITIES SHALL BE VERIFIED BY THE OWNER PRIOR TO ANY CONSTRUCTION. THE SURVEYOR MAKES NO GUARANTEE THAT THE UNDERGROUND UTILITIES SHOWN COMPRISE ALL SUCH UTILITIES IN THE AREA, EITHER IN SERVICE OR ABANDONED. THE SURVEYOR FURTHER DOES NOT WARRANT THAT THE UTILITIES SHOWN COMPRISE ALL SUCH UTILITIES IN THE AREA AS INDICATED. ADDITIONAL BURIED UTILITIES/STRUCTURES MAY BE ENCOUNTERED. THE CONTRACTOR SHALL DETERMINE THE EXACT LOCATION OF ALL EXISTING UTILITIES BEFORE COMMENCING WORK, AND AGREES TO BE FULLY RESPONSIBLE FOR ANY AND ALL DAMAGES PRESERVE ANY AND ALL UNDERGROUND UTILITIES. MASSDOT ASSUMES NO RESPONSIBILITY FOR DAMAGES INCURRED AS A RESULT OF UTILITIES OMITTED OR INACCURATELY SHOWN. IT IS ASSUMED THAT PIPES RUN STRAIGHT FROM STRUCTURE TO STRUCTURE. BEFORE PLANNING BE DETERMINED IN THE FIELD. SEVENTY-TWO (72) NON-WEEKEND/HOLIDAY HOURS PRIOR TO EXCAVATION, BLASTING, GRADING AND/OR PAVING, THE CONTRACTOR SHALL CONTACT THE DIG SAFE CALL CENTER AT 1-888-344-7235.

6. THE MASSACHUSETTS HIGHWAY RIGHT OF WAY DEPICTED HEREON IS BASED ON RECORD PLANS AND IS POSITIONED BASED ON MONUMENTS RECOVERED DURING FIELD SURVEY EFFORTS.
7. CITY/TOWN LINES AND ABUTTING PARCELS DEPICTED HEREON ARE APPROXIMATE ONLY AND ARE BASED UPON RECORD DEEDS, PLANS AND ASSESSORS INFORMATION.
8. IN THE EVENT THAT BENCHMARKS ESTABLISHED FOR THIS PROJECT AND PUBLISHED ON THIS SURVEY ARE DESTROYED, NOT RECOVERABLE OR A DISCREPANCY IS FOUND, THE CONTRACTOR SHALL NOTIFY THE ENGINEER IN WRITING PRIOR TO COMMENCING OR CONTINUING ANY WORK.
9. UNLESS OTHERWISE NOTED, DEED AND PLAN REFERENCES ARE TO THE WORCESTER COUNTY REGISTRY OF DEEDS.
10. CONTRACTOR SHALL CONFIRM EXISTING INVERTS BEFORE COMMENCING WORK.
11. WHERE AN EXISTING UTILITY IS FOUND TO CONFLICT WITH THE PROPOSED WORK, THE LOCATION, ELEVATION AND SIZE OF THE UTILITY SHALL BE ACCURATELY DETERMINED WITHOUT DELAY BY THE CONTRACTOR, AND THE INFORMATION FURNISHED TO THE ENGINEER FOR RESOLUTION OF THE CONFLICT.
12. THE CONTRACTOR SHALL ALTER THE MASONRY OF THE TOP SECTION OF ALL EXISTING DRAINAGE AND SEWER STRUCTURES AS NECESSARY FOR CHANGES IN GRADE, AND RESET ALL WATER, SEWER, AND DRAINAGE SURFACE CASTINGS (ETC.) WITHIN THE LIMITS OF EXISTING STRUCTURES TO MATCH EXISTING SURFACE GRADE. REQUIRED NEW MASONRY SHALL BE CLAY BRICK CONFORMING TO M4.62.

13. THE CONTRACTOR SHALL MAKE ALL ARRANGEMENTS FOR THE ALTERATION AND ADJUSTMENT OF ALL EXISTING ELECTRIC, TELEPHONE, AND ANY OTHER PRIVATE UTILITIES BY THE UTILITY COMPANIES.
14. THE CONTRACTOR SHALL ADJUST SURFACES (I.E. G. MILLED PAVEMENT SURFACES) AND TO MAINTAIN ROADWAY DRAINAGE.
15. ITEMS NOTED AS TO BE REMOVED AND STACKED SHALL BE COORDINATED WITH THE RESPECTIVE OWNER.
16. THE CONTRACTOR SHALL COMPLY WITH ALL REQUIREMENTS OF PERMITS, CONDITIONS AND LICENSES ISSUED BY FEDERAL, STATE AND LOCAL AGENCIES HAVING JURISDICTION.
17. EXISTING SUBSURFACE UTILITIES SHALL BE RETAINED EXCEPT WHERE OTHERWISE NOTED.
18. AREAS OUTSIDE THE LIMITS OF PROPOSED WORK DISTURBED BY THE CONTRACTORS SHALL BE RESTORED BY THE CONTRACTOR TO THEIR ORIGINAL CONDITION AT THE CONTRACTORS EXPENSE.
19. EXISTING SITE FEATURES AND LANDSCAPING WITHIN THE LIMITS OF WORK SHALL BE REMOVED AND REINSTALLED BY THE CONTRACTOR TO MATCH EXISTING CONDITIONS. THE CONTRACTOR SHALL BE IMPACTED BY THE CONTRACTORS OPERATIONS SHALL BE RESTORED BY THE CONTRACTOR TO THEIR ORIGINAL CONDITION EXCEPT WHERE OTHERWISE NOTED.
20. THE TERM "PROPOSED" PROPRIETARY MEANS WORK TO BE CONSTRUCTED USING NEW MATERIALS OR REUSING EXISTING MATERIALS IS IDENTIFIED AS "REMOVE AND RESET" (R&R).
21. THE CONTRACTOR SHALL REUSE EXISTING MATERIALS IDENTIFIED AS "REMOVE AND RESET"

- (R&R) TO THE MAXIMUM EXTENT POSSIBLE UNLESS THEY ARE DEEMED UNSUITABLE BY THE ENGINEER.
22. ALL MATERIAL SPECIFIED AS REMOVE AND STACK SHALL BE TRANSPORTED TO AND STACKED AT:  
 MASSDOT MAINTENANCE DEPOT AT 14 CHOCKETT ROAD, STERLING, MA.  
 OR  
 FITCHBURG CROW FACILITY AT 301 BROAD STREET, FITCHBURG, MA.  
 AS DIRECTED BY THE ENGINEER.
23. JOINTS BETWEEN NEW HOT MIX ASPHALT CONCRETE ROADWAY PAVEMENT AND SAWCUT EXISTING PAVEMENT SHALL BE SEALED WITH HMA JOINT SEALANT AND SANDED.
24. ALL EXISTING GRANITE CURBING SHALL BE REUSED TO THE MAXIMUM EXTENT POSSIBLE. EXCEPT WHERE CURVED STONES OF A DIFFERENT RADIUS THAN PROPOSED CURBS ARE, IT SHALL BE REMOVED AND DISPOSED OF BY THE CONTRACTOR. GRANITE CURB TO BE REUSED SHALL BE INSTALLED IN CONTINUOUS SECTIONS AND SHALL NOT BE INTERMIXED WITH NEW CURB.
25. ALL NEW VERTICAL GRANITE CURB SHALL BE MASSDOT TYPE WA-4, UNLESS SPECIFIED OTHERWISE.
26. ALL CURB DIMENSIONS ARE TO THE FACE OF CURB (GUTTER LINE).
27. ALL PROPOSED RELOCATED UTILITY POLES, HYDRANTS AND OTHER ABOVE GROUND STRUCTURES TO BE LOCATED WITHIN SIDEWALK AREAS SHALL BE LOCATED SO AS TO MAINTAIN A MINIMUM 4' CLEARANCE TO ALL ADJACENT SIDEWALKS AND PUBLIC RIGHT-OF-WAY ACCESSIBILITY GUIDELINES (PROVAG) CLEARANCE REQUIREMENTS.
28. EXISTING GRANEL BORROW DETERMINED TO BE SUITABLE BY THE ENGINEER AND MEETING THE REQUIREMENTS OF THE SPECIFICATIONS SHALL REMAIN.
29. CONTRACTOR SHALL MAINTAIN ALL EXISTING UTILITY SERVICES AND HIGHWAY LIGHTING THROUGHOUT CONSTRUCTION UNTIL, AND UNLESS THEY ARE REPLACED PER THE CONTRACT.
30. ALL DRAINAGE PIPES SHALL BE CLASS III REINFORCED CONCRETE PIPE EXCEPT WHERE NOTED. MINIMUM PIPE SLOPES OF 0.5% SHALL BE MAINTAINED.
31. CONTRACTOR SHALL PROVIDE BRACKETS, ROLLERS, AND SLEEVE FOR GAS MAIN INSTALLATION ON BRIDGE. CONTRACTOR SHALL INSTALL BRACKETS, AND SHALL NOTIFY UNTIL GAS COMPANY OF THE SLEEVE SIZE TO BE PROVIDED (MINIMUM 12 INCH SLEEVE FOR 8 INCH PIPE). CONTRACTOR SHALL PROVIDE BRACKETS, ROLLERS, AND CASING SPACERS AND END SEALS FOR SLEEVE FITTINGS, ROLLERS, AND CASING SPACERS AND END SEALS FOR SLEEVE.
32. TEMPORARY EROSION AND SEDIMENTATION CONTROL MEASURES SHALL BE INSTALLED PRIOR TO ANY EXCAVATION AND SHALL REMAIN IN PLACE UNTIL ALL SITEWORK IS COMPLETED AND GROUND COVER IS ESTABLISHED AT LEAST 75% UNIFORM COVERAGE BY NEW SEEDINGS).
33. THE CONTRACTOR SHALL INSPECT THE EROSION CONTROLS DAILY, AND CLEAN ACCUMULATED MATERIALS FOUND TO BE IN NEED OF REPAIR OR REPLACEMENT SHALL BE IMMEDIATELY CORRECTED. SO AS TO MAINTAIN THE INTEGRITY OF THE EROSION AND SEDIMENTATION CONTROL SYSTEM.
34. ALL DISTURBED AREAS THAT WILL REMAIN EXPOSED OR UNDISTURBED FOR A PERIOD OF FOURTEEN (14) DAYS OR LONGER SHALL BE STABILIZED WITH MULCH/ORG SEED FOR TEMPORARY VEGETATIVE COVER.
35. THE CONTRACTOR SHALL INSPECT ALL PORTIONS OF THE SITE IN ANTICIPATION OF RAINFALL AND/OR THE TRANSPORTATION OF SEDIMENTS WITHIN THE PROJECT LIMITS. ADDITIONAL MEASURES ARE REQUIRED. THEY ARE TO BE IMPLEMENTED IMMEDIATELY AT THE CONTRACTORS EXPENSE. IN NO CASE SHALL THE INSTALLATION OF ADDITIONAL MEASURES, NECESSARY TO PREVENT EROSION WITHIN THE PROJECT LIMITS, BE DELAYED BEYOND THE COMPLETION OF PRECIPITATION.
36. WHEN THE CONTROL SYSTEMS ARE NO LONGER REQUIRED, CONTRACTOR SHALL REMOVE ALL SEDIMENT AND SOIL FROM THE SITE AND RESTORE THEM TO ORIGINAL CONDITIONS. CONTRACTOR SHALL REQUEST AND RECEIVE PERMISSION FROM THE ENGINEER PRIOR TO REMOVING ANY CONTROL SYSTEM.
37. THE MINIMUM MOUNTING HEIGHT OF POST-MOUNTED SIGNS, MEASURED VERTICALLY FROM THE BOTTOM OF THE SIGN TO THE TOP OF THE CURB OR SIDEWALK, SHALL BE 7 FEET UNLESS OTHERWISE SPECIFIED.
38. PERMANENT PAVEMENT MARKINGS SHALL BE THERMOPLASTIC.
39. HYDRAULIC DATA SHOWN HEREON WAS PROVIDED BY THE MASSDOT HYDRAULIC SECTION IN THE HYDRAULIC STUDY REPORT DATED 02/08/2022.
40. CONTRACTOR SHALL OFFSET LONGITUDINAL PAVEMENT JOINTS BY 4" (MIN) FROM PROPOSED PAVEMENT MARKINGS.
41. PROPOSED TEMPORARY SIDEWALKS SHALL PROVIDE A MINIMUM ACCESSIBLE WIDTH OF 5 FEET EXCEPT AT POINT OBSTRUCTIONS WHERE A WIDTH OF 4 FEET WILL BE ACCEPTED. MAXIMUM CROSS SLOPE SHALL BE 1.5% AND THE MAXIMUM LONGITUDINAL SLOPE SHALL BE 4.5% (0.5% CONSTRUCTION TOLERANCE).
42. CONTRACTOR TO REMOVE SEDIMENT AND CLEAN ALL DRAINAGE STRUCTURES AND PIPES WITHIN PROJECT LIMITS.
43. CONTRACTOR SHALL PERFORM PRE- AND POST-CONSTRUCTION VIDEO INSPECTION OF EXISTING SANITARY SEWER SYSTEM WITHIN THE PROJECT LIMITS BEFORE BEGINNING CONSTRUCTION ACTIVITIES AND AFTER SUBSTANTIAL COMPLETION, RESPECTIVELY. ANY

**PEDESTRIAN CURB RAMP NOTES**

1. ALL SIDEWALKS AND PEDESTRIAN CURB RAMPS SHALL CONFORM TO THE REQUIREMENTS OF THE ARCHITECTURAL ACCESS BOARD (AAB), AMERICAN WITH DISABILITIES ACT (ADA), AND HIGHWAY DIVISION. SIDEWALK CROSS SLOPES, AS INDICATED IN THE STANDARD SPECIFICATIONS, WILL BE 1.5% MAXIMUM. CEMENT CONCRETE. LEVEL LANDINGS SHALL NOT EXCEED A SLOPE OF 1.5% IN ANY DIRECTION.
2. AN UNOBSTRUCTED PATH OF TRAVEL WITH A MINIMUM WIDTH OF 36" SHALL BE MAINTAINED PAST ALL OBSTRUCTIONS (UTILITY POLES, SIGNS, SIGNAL FOUNDATIONS AND MASTS, MAILBOXES, ALONG DRIVE OPENINGS, ETC.).
3. ALL EXISTING CURB TO BE REMOVED AND RESET (R&R) OR PROPOSED CURB FOR PEDESTRIAN CURB RAMP TRANSITIONS SHALL BE CUT AND TRANSITIONED AS NECESSARY TO PROVIDE THE CORRECT TRANSITION LENGTHS FOR EACH PEDESTRIAN CURB RAMP. AS EXISTING CURB INLETS IN AREAS OF NEW PEDESTRIAN CURB RAMP TRANSITIONS SHALL BE REMOVED AND REPLACED WITH APPROPRIATE TRANSITION CURB, AS DIRECTED BY THE ENGINEER.
4. IN NO CASE, EXCEPT MAXIMUM LENGTH HIGH SIDE TRANSITIONS, SHALL ANY TRANSITION SLOPE OF ANY PEDESTRIAN CURB RAMP EXCEED 7.5% WITH A MAXIMUM CONSTRUCTION TOLERANCE OF 0.5%. PROPOSED PEDESTRIAN CURB RAMP SLOPES SHALL BE VERIFIED BY THE CONTRACTOR PRIOR TO CONSTRUCTION USING A RANGING OF CONCRETE, AND ADJUSTED, IF NECESSARY, AT THE DIRECTION OF THE ENGINEER.
5. HIGH SIDE TRANSITION LENGTHS, AS SHOWN ON THE PLANS, SHALL BE VERIFIED BY THE CONTRACTOR CHECKING ASK/GUTTER GRADE, AND ANY NEW ADJUSTMENT SHALL BE MADE AT THE DIRECTION OF THE ENGINEER.
6. PEDESTRIAN CURB RAMP OFFSET FROM THE FINISH GRADE PAVEMENT NO GREATER THAN 1/2" AND NO LESS THAN 1/4" (PER CITY OF FITCHBURG REQUEST).
7. DETECTABLE WARNING PANELS SHALL BE INSTALLED PER MASSDOT STANDARD DETAIL E 107.6.5 FOR ALL PEDESTRIAN CURB RAMPS. DETECTABLE WARNING PANELS SHALL BE INSTALLED TO THE FULL WIDTH OF THE CURB. DETECTABLE WARNING PANELS TO BE INSTALLED TO THE FULL WIDTH OF THE CURB. DETECTABLE WARNING PANELS ARE TO BE CAST IRONS AND CONFORM WITH ADA REQUIREMENTS FOR DETECTABLE WARNING PANELS ON CURB RAMPS (PER CITY OF FITCHBURG REQUEST).
8. IN INSTANCES WHERE AN EXISTING MANHOLE, HANDHOLE, OR OTHER "SURFACE" TYPE STRUCTURE THAT CANNOT BE REMOVED OR RESET IS WITHIN THE PROPOSED OR EXISTING CURB RAMP, THE SURFACE SHALL BE REPAIRED TO ORIGINAL CONDITION. THE TOPMOST SURFACES ON THE STRUCTURE COVERS SHALL BE FLUSH WITH THE ACCESSIBLE SURFACE.

9. CONTRACTOR SHALL MAINTAIN ALL EXISTING UTILITY SERVICES AND HIGHWAY LIGHTING THROUGHOUT CONSTRUCTION UNTIL, AND UNLESS THEY ARE REPLACED PER THE CONTRACT.
10. ALL DRAINAGE PIPES SHALL BE CLASS III REINFORCED CONCRETE PIPE EXCEPT WHERE NOTED. MINIMUM PIPE SLOPES OF 0.5% SHALL BE MAINTAINED.
11. CONTRACTOR SHALL PROVIDE BRACKETS, ROLLERS, AND SLEEVE FOR GAS MAIN INSTALLATION ON BRIDGE. CONTRACTOR SHALL INSTALL BRACKETS, AND SHALL NOTIFY UNTIL GAS COMPANY OF THE SLEEVE SIZE TO BE PROVIDED (MINIMUM 12 INCH SLEEVE FOR 8 INCH PIPE). CONTRACTOR SHALL PROVIDE BRACKETS, ROLLERS, AND CASING SPACERS AND END SEALS FOR SLEEVE FITTINGS, ROLLERS, AND CASING SPACERS AND END SEALS FOR SLEEVE.
12. TEMPORARY EROSION AND SEDIMENTATION CONTROL MEASURES SHALL BE INSTALLED PRIOR TO ANY EXCAVATION AND SHALL REMAIN IN PLACE UNTIL ALL SITEWORK IS COMPLETED AND GROUND COVER IS ESTABLISHED AT LEAST 75% UNIFORM COVERAGE BY NEW SEEDINGS).
13. THE CONTRACTOR SHALL INSPECT THE EROSION CONTROLS DAILY, AND CLEAN ACCUMULATED MATERIALS FOUND TO BE IN NEED OF REPAIR OR REPLACEMENT SHALL BE IMMEDIATELY CORRECTED. SO AS TO MAINTAIN THE INTEGRITY OF THE EROSION AND SEDIMENTATION CONTROL SYSTEM.
14. ALL DISTURBED AREAS THAT WILL REMAIN EXPOSED OR UNDISTURBED FOR A PERIOD OF FOURTEEN (14) DAYS OR LONGER SHALL BE STABILIZED WITH MULCH/ORG SEED FOR TEMPORARY VEGETATIVE COVER.
15. THE CONTRACTOR SHALL INSPECT ALL PORTIONS OF THE SITE IN ANTICIPATION OF RAINFALL AND/OR THE TRANSPORTATION OF SEDIMENTS WITHIN THE PROJECT LIMITS. ADDITIONAL MEASURES ARE REQUIRED. THEY ARE TO BE IMPLEMENTED IMMEDIATELY AT THE CONTRACTORS EXPENSE. IN NO CASE SHALL THE INSTALLATION OF ADDITIONAL MEASURES, NECESSARY TO PREVENT EROSION WITHIN THE PROJECT LIMITS, BE DELAYED BEYOND THE COMPLETION OF PRECIPITATION.
16. WHEN THE CONTROL SYSTEMS ARE NO LONGER REQUIRED, CONTRACTOR SHALL REMOVE ALL SEDIMENT AND SOIL FROM THE SITE AND RESTORE THEM TO ORIGINAL CONDITIONS. CONTRACTOR SHALL REQUEST AND RECEIVE PERMISSION FROM THE ENGINEER PRIOR TO REMOVING ANY CONTROL SYSTEM.
17. THE MINIMUM MOUNTING HEIGHT OF POST-MOUNTED SIGNS, MEASURED VERTICALLY FROM THE BOTTOM OF THE SIGN TO THE TOP OF THE CURB OR SIDEWALK, SHALL BE 7 FEET UNLESS OTHERWISE SPECIFIED.
18. PERMANENT PAVEMENT MARKINGS SHALL BE THERMOPLASTIC.
19. HYDRAULIC DATA SHOWN HEREON WAS PROVIDED BY THE MASSDOT HYDRAULIC SECTION IN THE HYDRAULIC STUDY REPORT DATED 02/08/2022.
20. CONTRACTOR SHALL OFFSET LONGITUDINAL PAVEMENT JOINTS BY 4" (MIN) FROM PROPOSED PAVEMENT MARKINGS.
21. PROPOSED TEMPORARY SIDEWALKS SHALL PROVIDE A MINIMUM ACCESSIBLE WIDTH OF 5 FEET EXCEPT AT POINT OBSTRUCTIONS WHERE A WIDTH OF 4 FEET WILL BE ACCEPTED. MAXIMUM CROSS SLOPE SHALL BE 1.5% AND THE MAXIMUM LONGITUDINAL SLOPE SHALL BE 4.5% (0.5% CONSTRUCTION TOLERANCE).
22. CONTRACTOR TO REMOVE SEDIMENT AND CLEAN ALL DRAINAGE STRUCTURES AND PIPES WITHIN PROJECT LIMITS.
23. CONTRACTOR SHALL PERFORM PRE- AND POST-CONSTRUCTION VIDEO INSPECTION OF EXISTING SANITARY SEWER SYSTEM WITHIN THE PROJECT LIMITS BEFORE BEGINNING CONSTRUCTION ACTIVITIES AND AFTER SUBSTANTIAL COMPLETION, RESPECTIVELY. ANY

607680.DWG (CONSTRUCTION PLANS) DWG  
 2023-11-21 11:21 AM

|                       |        |
|-----------------------|--------|
| FITCHBURG             |        |
| RIVER STREET/ROUTE 31 |        |
| STATE                 | MA     |
| FED. PROJ. NO.        | 7      |
| PROJECT FILE NO.      | 607680 |
| CONSTRUCTION PLANS    |        |

TRAFFIC SIGNAL CONDUIT  
 NONE

HIGHWAY GUARD DETAILS  
 NONE

DRAINAGE & UTILITY PLANS  
 SEE SHEET 11

DRAINAGE DETAILS  
 SEE SHEET 12-13

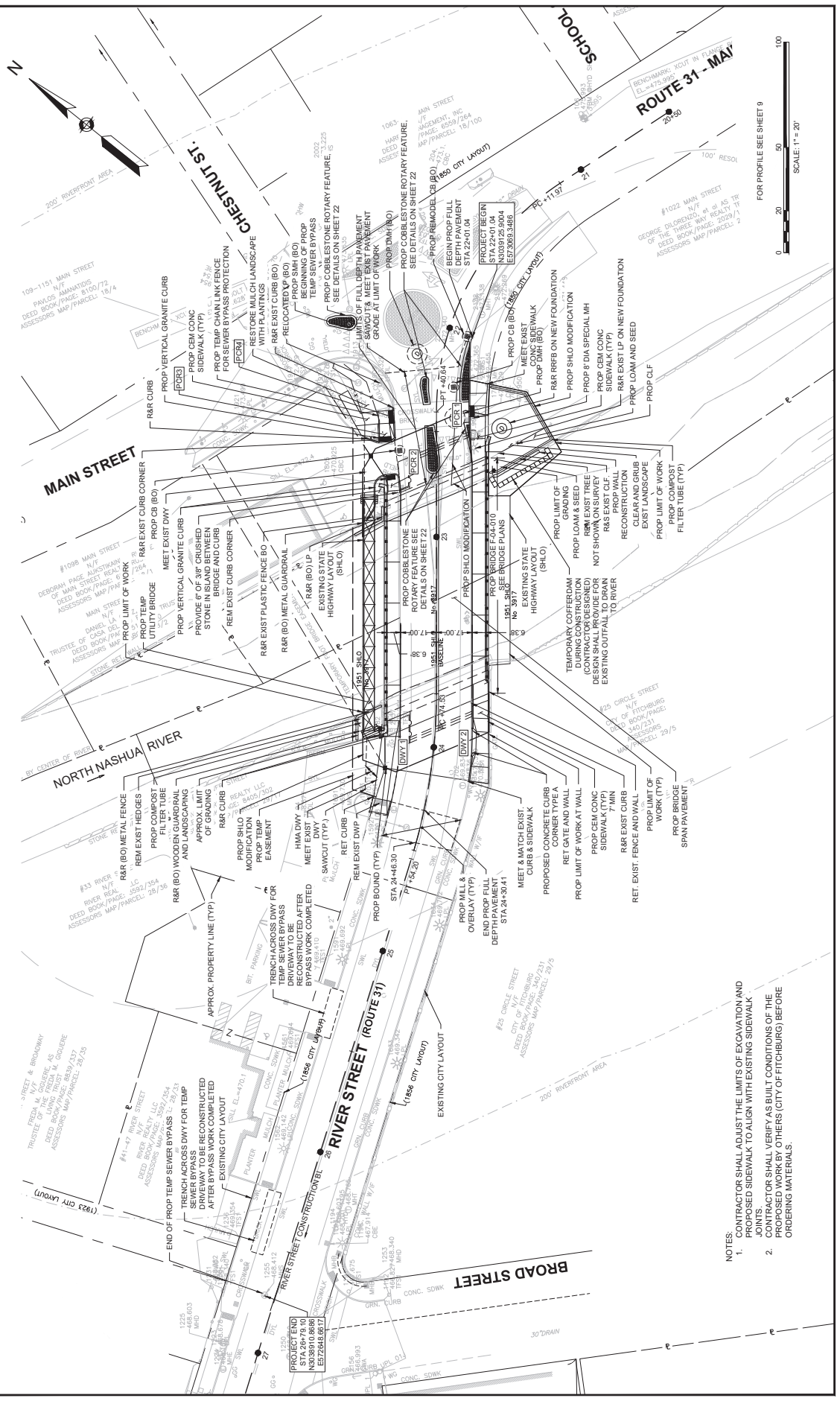

- NOTES:
- CONTRACTOR SHALL ADJUST THE LIMITS OF EXCAVATION AND PROPOSED SIDEWALK TO ALIGN WITH EXISTING SIDEWALK JOINTS.
  - CONTRACTOR SHALL VERIFY AS BUILT CONDITIONS OF THE PROPOSED WORK BY OTHERS (CITY OF FITCHBURG) BEFORE ORDERING MATERIALS.

**FITCHBURG  
RIVER STREET (ROUTE 31)  
GRADING PLANS**

|                  |        |
|------------------|--------|
| STATE            | MA     |
| REG. APPROX. NO. | 10     |
| REG. SHEET NO.   | 08     |
| PROJECT FILE NO. | 607680 |

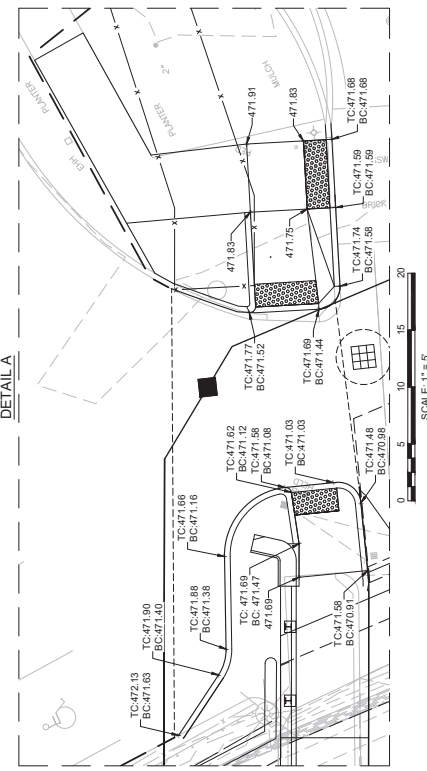
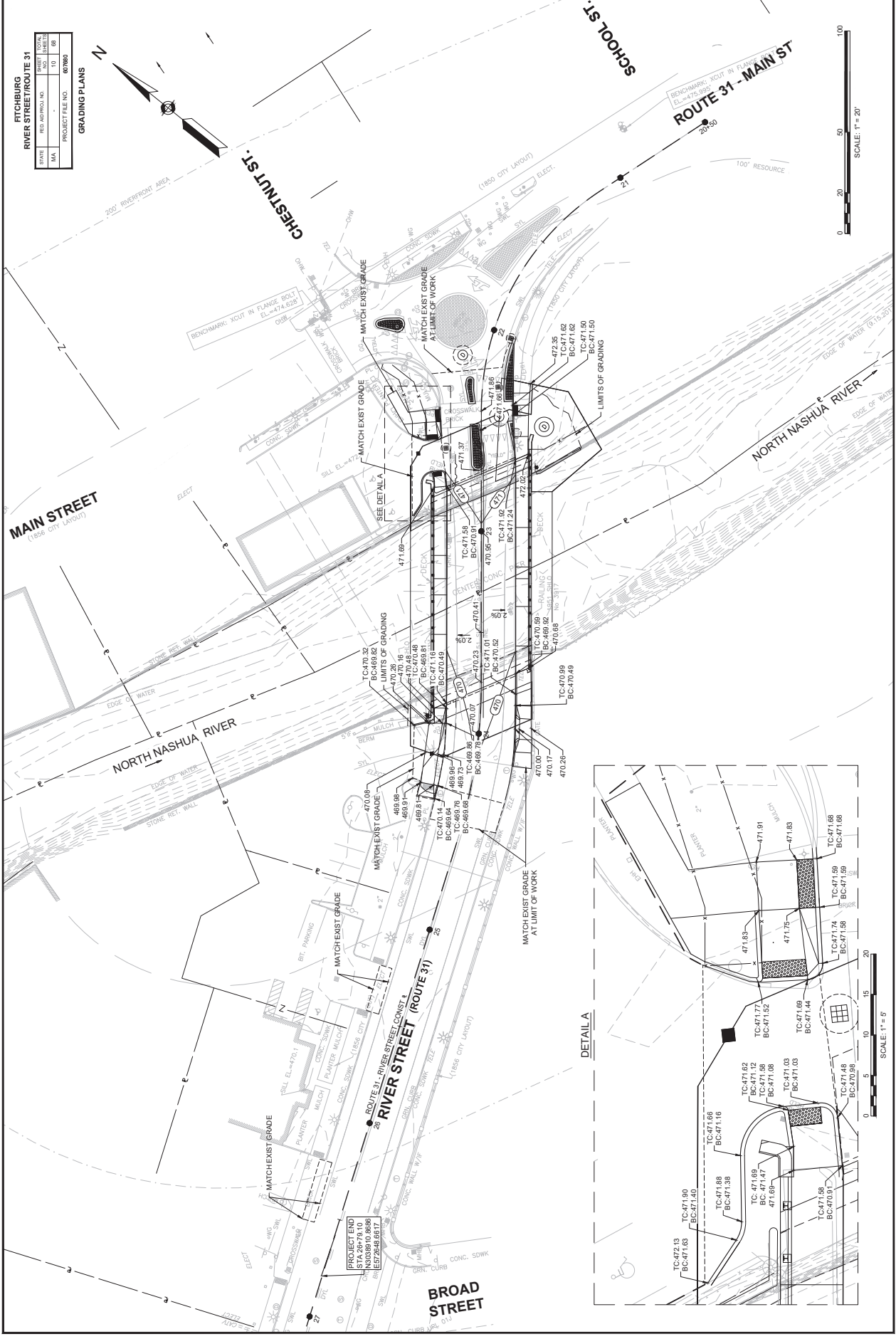

|  |        |
|--|--------|
| FITCHBURG<br>RIVER STREET (ROUTE 31)<br>DRAINAGE & UTILITY PLANS |        |
| STATE  | MA     |
| FED. PROJ. NO.   | 11     |
| PROJECT FILE NO.   | 607680 |
| NO.  | 08     |

100' RESOURCE

SCALE: 1" = 20'

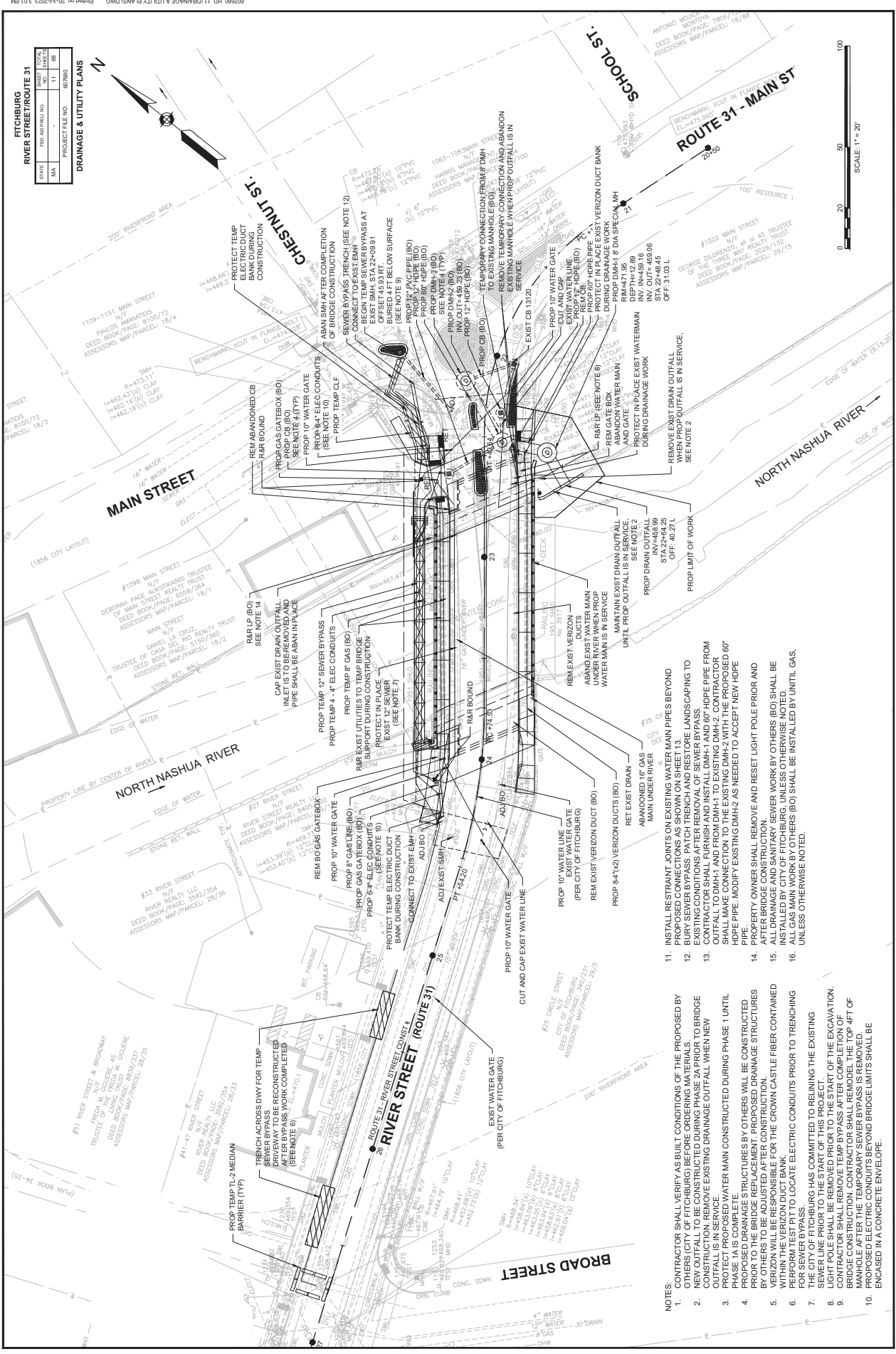

- NOTES:**
- CONTRACTOR SHALL VERIFY AS BUILT CONDITIONS OF THE PROPOSED BY PHASE 1A AND PHASE 1B BEFORE CONSTRUCTION OF PHASE 2A.
  - NEW OUTFALL TO BE CONSTRUCTED DURING PHASE 2A PRIOR TO BRIDGE CONSTRUCTION. REMOVE EXISTING DRAINAGE OUTFALL WHEN NEW OUTFALL IS IN SERVICE.
  - PROTECT PROPOSED WATER MAIN CONSTRUCTED DURING PHASE 1 UNTIL PHASE 1A IS COMPLETE. STRUCTURES BY OTHERS WILL BE CONSTRUCTED PRIOR TO THE BRIDGE REPLACEMENT. PROPOSED DRAINAGE STRUCTURES BY OTHERS TO BE ADJUSTED AFTER CONSTRUCTION.
  - VERIZON WILL BE RESPONSIBLE FOR THE CROWN CASTLE FIBER CONTAINED WITHIN THE VERIZON DUCT BANK.
  - PERFORM TEST PIT TO LOCATE ELECTRIC CONDUITS PRIOR TO TRENCHING.
  - THE CITY OF FITCHBURG HAS COMMITTED TO REINJURING THE EXISTING SEWER LINE PRIOR TO THE START OF THIS PROJECT.
  - LIGHT POLE SHALL BE REMOVED PRIOR TO THE START OF THE EXCAVATION. CONTRACTOR SHALL REMOVE TEMP BYPASS AFTER COMPLETION OF BRIDGE CONSTRUCTION. CONTRACTOR SHALL REMODEL THE TOP 4 FT OF EXCAVATION TO MATCH EXISTING FINISH GRADE. ALL UTILITIES SHALL BE PROPOSED ELECTRIC CONDUITS BEYOND AND BRIDGE LIMITS SHALL BE ENCASED IN A CONCRETE ENVELOPE.
  - CONTRACTOR SHALL VERIFY AS SHOWN ON SHEET 12. LANDSCAPING TO EXISTING CONDITIONS AFTER REMOVAL OF SEWER BYPASS.
  - CONTRACTOR SHALL FURNISH AND INSTALL DMH-1 AND 80\"/>

**FITCHBURG**  
**ST 31 (RIVER STREET) OVER NORTH NASHUA RIVER**  
**NORTH FLOOD WALL DEMOLITION**  
**AND RECONSTRUCTION FOR OUTFALL PIPE**

|                  |               |             |
|------------------|---------------|-------------|
| DATE             | REV. APPROVAL | SHEET TOTAL |
| 1/24/23          | MA            | NO. LABEL   |
|                  |               | 41 / 60     |
| PROJECT FILE NO. |               | 607680      |

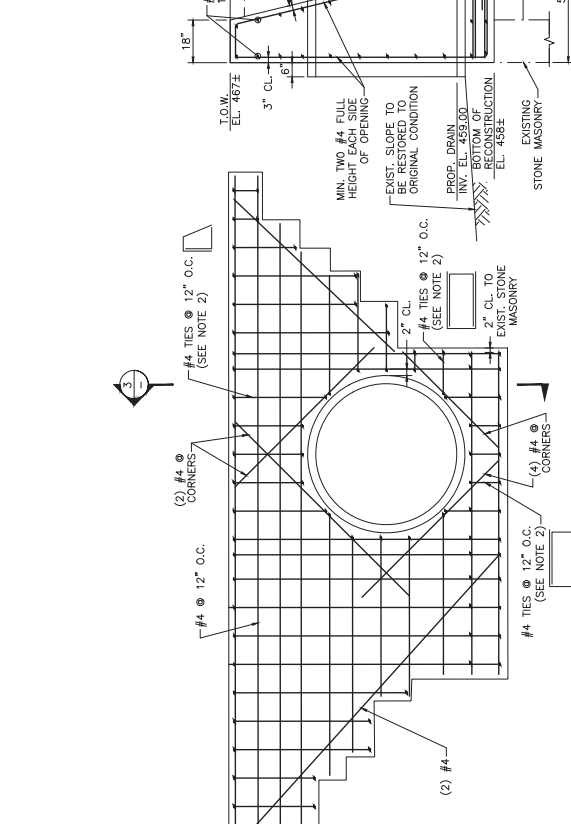

**PLAN**  
 SCALE: 1/4" = 1'-0"

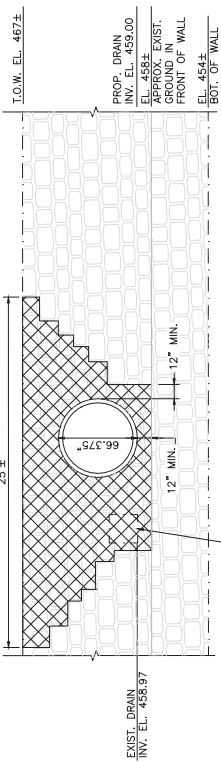

**ELEVATION — EXCAVATION LIMITS**  
 SCALE: 1/4" = 1'-0"

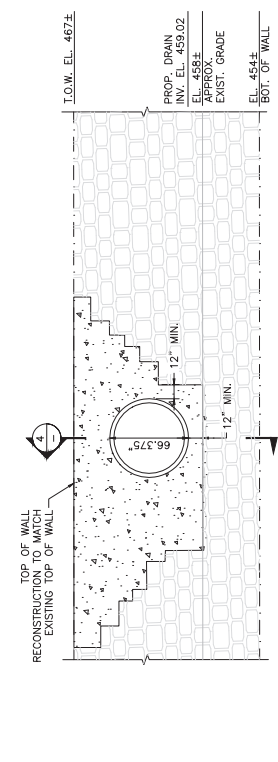

**PROPOSED RECONSTRUCTION ELEVATION**  
 SCALE: 1/4" = 1'-0"

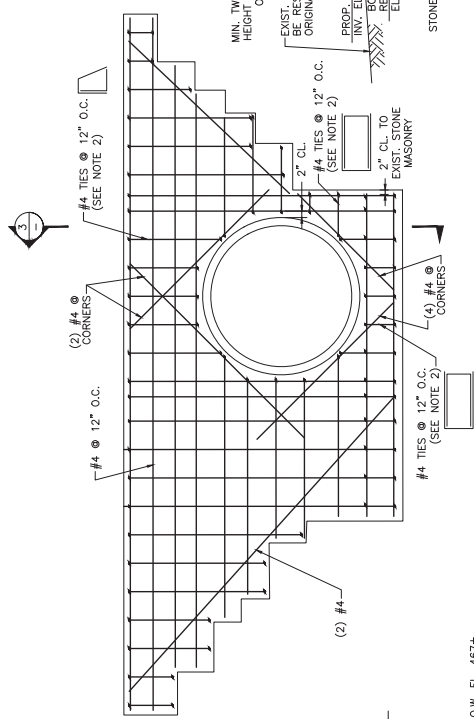

**ELEVATION — REINFORCING**  
 SCALE: 1/4" = 1'-0"

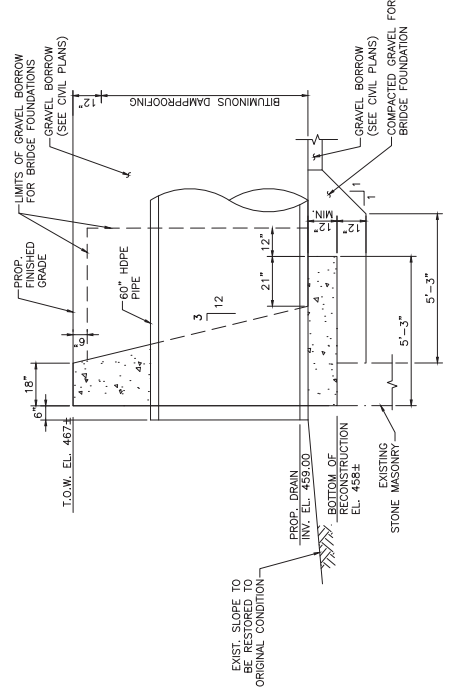

**SECTION 3**  
 SCALE: 1/4" = 1'-0"

- NOTES:**
- LIMITS SHOWN ARE APPROXIMATE. LIMITS TO BE CONFIRMED IN FIELD BASED ON PRECONSTRUCTION SURVEY.
  - WHERE DIMENSIONS ARE TOO SMALL TO ALLOW FOR CLEAR COVER PLUS DEVELOPMENT OF STRAIGHT BARS, TIES SHALL BE USED.

**LEGEND:**

|          |                   |
|----------|-------------------|
| [Symbol] | BRIDGE            |
| [Symbol] | EXCAVATION        |
| [Symbol] | PROPOSED CONCRETE |

|  |                         |
|--|-------------------------|
| DATE   | ISSUED FOR CONSTRUCTION |
| 1/24/23  |                         |
| THIS SHEET IS APPROVED FOR CONSTRUCTION BY MASSDOT |                         |
| MASSDOT SIGNATURE                                  | STATE BRIDGE ENGINEER   |
| DATE   | ISSUED FOR CONSTRUCTION |
| 1/24/23  |                         |
| USE ONLY PRINTS OF LATEST DATE                     |                         |

SHEET 17 OF 38 SHEETS BRIDGE NO. F-04-010 (1KR)





---

**ATTACHMENT C –IPaC Consultation**



## United States Department of the Interior



FISH AND WILDLIFE SERVICE  
New England Ecological Services Field Office  
70 Commercial Street, Suite 300  
Concord, NH 03301-5094  
Phone: (603) 223-2541 Fax: (603) 223-0104

In Reply Refer To:  
Project Code: 2023-0068776  
Project Name: River Street Bridge Replacement

April 13, 2023

Subject: List of threatened and endangered species that may occur in your proposed project location or may be affected by your proposed project

To Whom It May Concern:

*Updated 3/8/2023 - Please review this letter each time you request an Official Species List, we will continue to update it with additional information and links to websites may change.*

### **About Official Species Lists**

The purpose of the Act is to provide a means whereby threatened and endangered species and the ecosystems upon which they depend may be conserved. Federal and non-Federal project proponents have responsibilities under the Act to consider effects on listed species.

The enclosed species list identifies threatened, endangered, proposed, and candidate species, as well as proposed and final designated critical habitat, that may occur within the boundary of your proposed project and/or may be affected by your proposed project. The species list fulfills the requirements of the U.S. Fish and Wildlife Service (Service) under section 7(c) of the Endangered Species Act (Act) of 1973, as amended (16 U.S.C. 1531 et seq.).

New information based on updated surveys, changes in the abundance and distribution of species, changed habitat conditions, or other factors could change this list. Please note that under 50 CFR 402.12(e) of the regulations implementing section 7 of the Act, the accuracy of this species list should be verified after 90 days. The Service recommends that verification be completed by visiting the ECOS-IPaC website at regular intervals during project planning and implementation for updates to species lists and information. An updated list may be requested by returning to an existing project's page in IPaC.

### **Endangered Species Act Project Review**

Please visit the “**New England Field Office Endangered Species Project Review and Consultation**” website for step-by-step instructions on how to consider effects on listed



species and prepare and submit a project review package if necessary:

<https://www.fws.gov/office/new-england-ecological-services/endangered-species-project-review>

**\*NOTE\*** Please do not use the **Consultation Package Builder** tool in IPaC except in specific situations following coordination with our office. Please follow the project review guidance on our website instead and reference your **Project Code** in all correspondence.

**Northern Long-eared Bat - (Updated 3/8/2023)** The Service published a final rule to reclassify the northern long-eared bat (NLEB) as endangered on November 30, 2022. The final rule will go into effect on **March 31, 2023**. After that date, the current 4(d) rule for NLEB will be invalid, and the 4(d) determination key will no longer be available. New compliance tools will be available in March 2023, and information will be posted in this section on our website and on the northern long-eared bat species page, so please check this site often for updates.

Depending on the type of effects a project has on NLEB, the change in the species' status may trigger the need to re-initiate consultation for any actions that are not completed and for which the Federal action agency retains discretion once the new listing determination becomes effective. If your project may result in incidental take of NLEB after the new listing goes into effect, this will need to be addressed in an updated consultation that includes an Incidental Take Statement. Many of these situations will be addressed through the new compliance tools. If your project may require re-initiation of consultation, please wait for information on the new tools to appear on this site or contact our office for additional guidance.

#### *Additional Info About Section 7 of the Act*

Under section 7(a)(2) of the Act and its implementing regulations (50 CFR 402 et seq.), Federal agencies are required to determine whether projects may affect threatened and endangered species and/or designated critical habitat. If a Federal agency, or its non-Federal representative, determines that listed species and/or designated critical habitat may be affected by the proposed project, the agency is required to consult with the Service pursuant to 50 CFR 402. In addition, the Federal agency also may need to consider proposed species and proposed critical habitat in the consultation. 50 CFR 402.14(c)(1) specifies the information required for consultation under the Act regardless of the format of the evaluation. More information on the regulations and procedures for section 7 consultation, including the role of permit or license applicants, can be found in the "Endangered Species Consultation Handbook" at:

<https://www.fws.gov/service/section-7-consultations>

In addition to consultation requirements under Section 7(a)(2) of the ESA, please note that under sections 7(a)(1) of the Act and its implementing regulations (50 CFR 402 et seq.), Federal agencies are required to utilize their authorities to carry out programs for the conservation of threatened and endangered species. Please contact NEFO if you would like more information.

**Candidate species** that appear on the enclosed species list have no current protections under the ESA. The species' occurrence on an official species list does not convey a requirement to

consider impacts to this species as you would a proposed, threatened, or endangered species. The ESA does not provide for interagency consultations on candidate species under section 7, however, the Service recommends that all project proponents incorporate measures into projects to benefit candidate species and their habitats wherever possible.

### **Migratory Birds**

In addition to responsibilities to protect threatened and endangered species under the Endangered Species Act (ESA), there are additional responsibilities under the Migratory Bird Treaty Act (MBTA) and the Bald and Golden Eagle Protection Act (BGEPA) to protect native birds from project-related impacts. Any activity, intentional or unintentional, resulting in take of migratory birds, including eagles, is prohibited unless otherwise permitted by the U.S. Fish and Wildlife Service (50 C.F.R. Sec. 10.12 and 16 U.S.C. Sec. 668(a)). For more information regarding these Acts see:

<https://www.fws.gov/program/migratory-bird-permit>

<https://www.fws.gov/library/collections/bald-and-golden-eagle-management>

Please feel free to contact us at **newengland@fws.gov** with your **Project Code** in the subject line if you need more information or assistance regarding the potential impacts to federally proposed, listed, and candidate species and federally designated and proposed critical habitat.

Attachment(s): Official Species List

Attachment(s):

- Official Species List

## **OFFICIAL SPECIES LIST**

This list is provided pursuant to Section 7 of the Endangered Species Act, and fulfills the requirement for Federal agencies to "request of the Secretary of the Interior information whether any species which is listed or proposed to be listed may be present in the area of a proposed action".

This species list is provided by:

**New England Ecological Services Field Office**

70 Commercial Street, Suite 300

Concord, NH 03301-5094

(603) 223-2541

## PROJECT SUMMARY

Project Code: 2023-0068776  
Project Name: River Street Bridge Replacement  
Project Type: Culvert Repair/Replacement/Maintenance  
Project Description: Replacement of the existing River Street Bridge over the North Nashua River and the replacement of an adjacent culvert carrying stormwater outfall.

Project Location:

The approximate location of the project can be viewed in Google Maps: <https://www.google.com/maps/@42.586955,-71.80879696909344,14z>

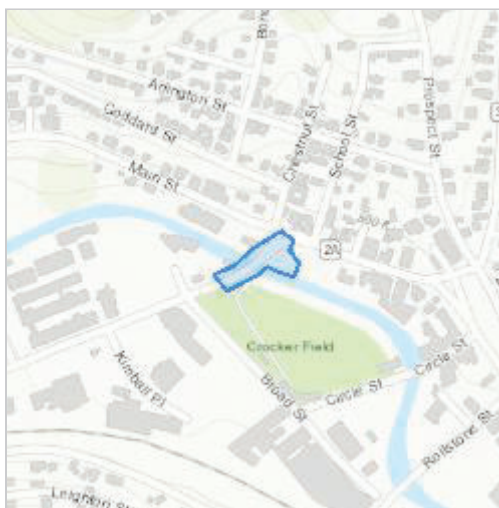

Counties: Worcester County, Massachusetts

## ENDANGERED SPECIES ACT SPECIES

There is a total of 2 threatened, endangered, or candidate species on this species list.

Species on this list should be considered in an effects analysis for your project and could include species that exist in another geographic area. For example, certain fish may appear on the species list because a project could affect downstream species.

IPaC does not display listed species or critical habitats under the sole jurisdiction of NOAA Fisheries<sup>1</sup>, as USFWS does not have the authority to speak on behalf of NOAA and the Department of Commerce.

See the "Critical habitats" section below for those critical habitats that lie wholly or partially within your project area under this office's jurisdiction. Please contact the designated FWS office if you have questions.

- 
1. [NOAA Fisheries](#), also known as the National Marine Fisheries Service (NMFS), is an office of the National Oceanic and Atmospheric Administration within the Department of Commerce.

## MAMMALS

| NAME   | STATUS     |
|--|------------|
| Northern Long-eared Bat <i>Myotis septentrionalis</i><br>No critical habitat has been designated for this species.<br>Species profile: <a href="https://ecos.fws.gov/ecp/species/9045">https://ecos.fws.gov/ecp/species/9045</a> | Endangered |

## INSECTS

| NAME   | STATUS    |
|--|-----------|
| Monarch Butterfly <i>Danaus plexippus</i><br>No critical habitat has been designated for this species.<br>Species profile: <a href="https://ecos.fws.gov/ecp/species/9743">https://ecos.fws.gov/ecp/species/9743</a> | Candidate |

## CRITICAL HABITATS

THERE ARE NO CRITICAL HABITATS WITHIN YOUR PROJECT AREA UNDER THIS OFFICE'S JURISDICTION.

## **IPAC USER CONTACT INFORMATION**

Agency: TRC  
Name: Gregory Russo  
Address: 650 Suffolk Street  
Address Line 2: Suite 200  
City: Lowell  
State: MA  
Zip: 01854  
Email: grusso@trccompanies.com  
Phone: 9789415834



---

**ATTACHMENT D – Photo Log**



**PHOTOGRAPHIC LOG**  
River Street Bridge Replacement

|   |  |                             |
|---|--|-----------------------------|
| <b>Client Name:</b><br>Massachusetts Department of Transportation | <b>Site Location:</b><br>0 Main St., Fitchburg, MA | <b>Project No.</b><br>----- |
|---|--|-----------------------------|

|   |
|---|
| <b>Photo No. 1.</b>   |
| <b>Date:</b><br>5/18/2023   |
| <b>Description:</b><br><br>Bridge F-04-010 over the North Nashua River. |



|  |
|--|
| <b>Photo No. 2.</b>  |
| <b>Date:</b><br>5/18/2023  |
| <b>Description:</b><br><br>Cobble/gravel substrate of North Nashua River on upstream side of the bridge. |







# PHOTOGRAPHIC LOG

## River Street Bridge Replacement

|   |  |                             |
|---|--|-----------------------------|
| <b>Client Name:</b><br>Massachusetts Department of Transportation | <b>Site Location:</b><br>0 Main St., Fitchburg, MA | <b>Project No.</b><br>----- |
|---|--|-----------------------------|

|  |
|--|
| <b>Photo No. 3.</b>  |
| <b>Date:</b><br>5/18/2023                                    |
| <b>Description:</b><br>River Street over North Nashua River. |



|   |
|---|
| <b>Photo No. 4.</b>   |
| <b>Date:</b><br>5/18/2023   |
| <b>Description:</b><br>Top of floodwall to be partially demolished for culvert replacement. |





**PHOTOGRAPHIC LOG**  
River Street Bridge Replacement

|   |  |                             |
|---|--|-----------------------------|
| <b>Client Name:</b><br>Massachusetts Department of Transportation | <b>Site Location:</b><br>0 Main St., Fitchburg, MA | <b>Project No.</b><br>----- |
|---|--|-----------------------------|

**Photo No. 5.**

**Date:**  
5/18/2023

**Description:**  
Cobble/gravel and concrete substrate of North Nashua River on downstream side of bridge.



**Photo No. 6.**

**Date:**  
5/18/2023

**Description:**  
Discharge point of old culvert to be replaced.

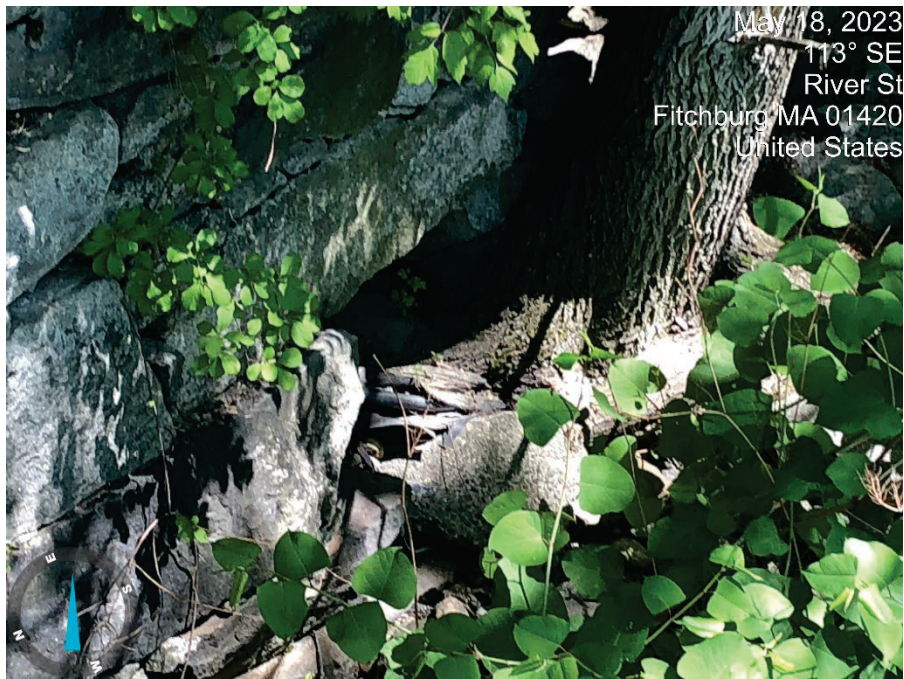



---

## **ATTACHMENT E – Stormwater Report**



**Massachusetts Department of Environmental Protection  
Bureau of Resource Protection - Wetlands Program**

# Checklist for Stormwater Report

## A. Introduction

**Important:** When filling out forms on the computer, use only the tab key to move your cursor - do not use the return key.



A Stormwater Report must be submitted with the Notice of Intent permit application to document compliance with the Stormwater Management Standards. The following checklist is NOT a substitute for the Stormwater Report (which should provide more substantive and detailed information) but is offered here as a tool to help the applicant organize their Stormwater Management documentation for their Report and for the reviewer to assess this information in a consistent format. As noted in the Checklist, the Stormwater Report must contain the engineering computations and supporting information set forth in Volume 3 of the [Massachusetts Stormwater Handbook](#). The Stormwater Report must be prepared and certified by a Registered Professional Engineer (RPE) licensed in the Commonwealth.

The Stormwater Report must include:

- The Stormwater Checklist completed and stamped by a Registered Professional Engineer (see page 2) that certifies that the Stormwater Report contains all required submittals.<sup>1</sup> This Checklist is to be used as the cover for the completed Stormwater Report.
- Applicant/Project Name
- Project Address
- Name of Firm and Registered Professional Engineer that prepared the Report
- Long-Term Pollution Prevention Plan required by Standards 4-6
- Construction Period Pollution Prevention and Erosion and Sedimentation Control Plan required by Standard 8<sup>2</sup>
- Operation and Maintenance Plan required by Standard 9

In addition to all plans and supporting information, the Stormwater Report must include a brief narrative describing stormwater management practices, including environmentally sensitive site design and LID techniques, along with a diagram depicting runoff through the proposed BMP treatment train. Plans are required to show existing and proposed conditions, identify all wetland resource areas, NRCS soil types, critical areas, Land Uses with Higher Potential Pollutant Loads (LUHPPL), and any areas on the site where infiltration rate is greater than 2.4 inches per hour. The Plans shall identify the drainage areas for both existing and proposed conditions at a scale that enables verification of supporting calculations.

As noted in the Checklist, the Stormwater Management Report shall document compliance with each of the Stormwater Management Standards as provided in the Massachusetts Stormwater Handbook. The soils evaluation and calculations shall be done using the methodologies set forth in Volume 3 of the Massachusetts Stormwater Handbook.

To ensure that the Stormwater Report is complete, applicants are required to fill in the Stormwater Report Checklist by checking the box to indicate that the specified information has been included in the Stormwater Report. If any of the information specified in the checklist has not been submitted, the applicant must provide an explanation. The completed Stormwater Report Checklist and Certification must be submitted with the Stormwater Report.

<sup>1</sup> The Stormwater Report may also include the Illicit Discharge Compliance Statement required by Standard 10. If not included in the Stormwater Report, the Illicit Discharge Compliance Statement must be submitted prior to the discharge of stormwater runoff to the post-construction best management practices.

<sup>2</sup> For some complex projects, it may not be possible to include the Construction Period Erosion and Sedimentation Control Plan in the Stormwater Report. In that event, the issuing authority has the discretion to issue an Order of Conditions that approves the project and includes a condition requiring the proponent to submit the Construction Period Erosion and Sedimentation Control Plan before commencing any land disturbance activity on the site.



Massachusetts Department of Environmental Protection  
Bureau of Resource Protection - Wetlands Program

# Checklist for Stormwater Report

## B. Stormwater Checklist and Certification

The following checklist is intended to serve as a guide for applicants as to the elements that ordinarily need to be addressed in a complete Stormwater Report. The checklist is also intended to provide conservation commissions and other reviewing authorities with a summary of the components necessary for a comprehensive Stormwater Report that addresses the ten Stormwater Standards.

*Note:* Because stormwater requirements vary from project to project, it is possible that a complete Stormwater Report may not include information on some of the subjects specified in the Checklist. If it is determined that a specific item does not apply to the project under review, please note that the item is not applicable (N.A.) and provide the reasons for that determination.

A complete checklist must include the Certification set forth below signed by the Registered Professional Engineer who prepared the Stormwater Report.

### Registered Professional Engineer's Certification

I have reviewed the Stormwater Report, including the soil evaluation, computations, Long-term Pollution Prevention Plan, the Construction Period Erosion and Sedimentation Control Plan (if included), the Long-term Post-Construction Operation and Maintenance Plan, the Illicit Discharge Compliance Statement (if included) and the plans showing the stormwater management system, and have determined that they have been prepared in accordance with the requirements of the Stormwater Management Standards as further elaborated by the Massachusetts Stormwater Handbook. I have also determined that the information presented in the Stormwater Checklist is accurate and that the information presented in the Stormwater Report accurately reflects conditions at the site as of the date of this permit application.

Registered Professional Engineer Block and Signature

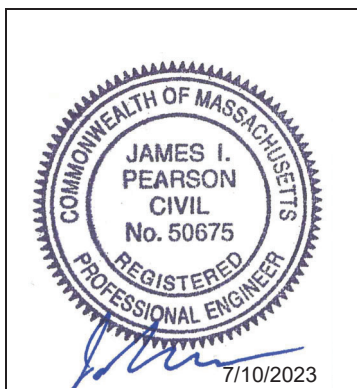

 7/10/2023  
Signature and Date

## Checklist

**Project Type:** Is the application for new development, redevelopment, or a mix of new and redevelopment?

- New development
- Redevelopment
- Mix of New Development and Redevelopment



**Massachusetts Department of Environmental Protection**  
 Bureau of Resource Protection - Wetlands Program

# Checklist for Stormwater Report

## Checklist (continued)

**LID Measures:** Stormwater Standards require LID measures to be considered. Document what environmentally sensitive design and LID Techniques were considered during the planning and design of the project:

- No disturbance to any Wetland Resource Areas
- Site Design Practices (e.g. clustered development, reduced frontage setbacks)
- Reduced Impervious Area (Redevelopment Only)
- Minimizing disturbance to existing trees and shrubs
- LID Site Design Credit Requested:
  - Credit 1
  - Credit 2
  - Credit 3
- Use of “country drainage” versus curb and gutter conveyance and pipe
- Bioretention Cells (includes Rain Gardens)
- Constructed Stormwater Wetlands (includes Gravel Wetlands designs)
- Treebox Filter
- Water Quality Swale
- Grass Channel
- Green Roof
- Other (describe): \_\_\_\_\_

### Standard 1: No New Untreated Discharges

- No new untreated discharges
- Outlets have been designed so there is no erosion or scour to wetlands and waters of the Commonwealth
- Supporting calculations specified in Volume 3 of the Massachusetts Stormwater Handbook included.



**Massachusetts Department of Environmental Protection  
Bureau of Resource Protection - Wetlands Program**

# Checklist for Stormwater Report

## Checklist (continued)

### Standard 2: Peak Rate Attenuation

- Standard 2 waiver requested because the project is located in land subject to coastal storm flowage and stormwater discharge is to a wetland subject to coastal flooding.
- Evaluation provided to determine whether off-site flooding increases during the 100-year 24-hour storm.
- Calculations provided to show that post-development peak discharge rates do not exceed pre-development rates for the 2-year and 10-year 24-hour storms. If evaluation shows that off-site flooding increases during the 100-year 24-hour storm, calculations are also provided to show that post-development peak discharge rates do not exceed pre-development rates for the 100-year 24-hour storm.

### Standard 3: Recharge

- Soil Analysis provided.
- Required Recharge Volume calculation provided.
- Required Recharge volume reduced through use of the LID site Design Credits.
- Sizing the infiltration, BMPs is based on the following method: Check the method used.
  - Static
  - Simple Dynamic
  - Dynamic Field<sup>1</sup>
- Runoff from all impervious areas at the site discharging to the infiltration BMP.
- Runoff from all impervious areas at the site is *not* discharging to the infiltration BMP and calculations are provided showing that the drainage area contributing runoff to the infiltration BMPs is sufficient to generate the required recharge volume.
- Recharge BMPs have been sized to infiltrate the Required Recharge Volume.
- Recharge BMPs have been sized to infiltrate the Required Recharge Volume *only* to the maximum extent practicable for the following reason:
  - Site is comprised solely of C and D soils and/or bedrock at the land surface
  - M.G.L. c. 21E sites pursuant to 310 CMR 40.0000
  - Solid Waste Landfill pursuant to 310 CMR 19.000
  - Project is otherwise subject to Stormwater Management Standards only to the maximum extent practicable.
- Calculations showing that the infiltration BMPs will drain in 72 hours are provided.
- Property includes a M.G.L. c. 21E site or a solid waste landfill and a mounding analysis is included.

<sup>1</sup> 80% TSS removal is required prior to discharge to infiltration BMP if Dynamic Field method is used.



**Massachusetts Department of Environmental Protection  
Bureau of Resource Protection - Wetlands Program**

# Checklist for Stormwater Report

## Checklist (continued)

### Standard 3: Recharge (continued)

- The infiltration BMP is used to attenuate peak flows during storms greater than or equal to the 10-year 24-hour storm and separation to seasonal high groundwater is less than 4 feet and a mounding analysis is provided.
- Documentation is provided showing that infiltration BMPs do not adversely impact nearby wetland resource areas.

### Standard 4: Water Quality

The Long-Term Pollution Prevention Plan typically includes the following:

- Good housekeeping practices;
  - Provisions for storing materials and waste products inside or under cover;
  - Vehicle washing controls;
  - Requirements for routine inspections and maintenance of stormwater BMPs;
  - Spill prevention and response plans;
  - Provisions for maintenance of lawns, gardens, and other landscaped areas;
  - Requirements for storage and use of fertilizers, herbicides, and pesticides;
  - Pet waste management provisions;
  - Provisions for operation and management of septic systems;
  - Provisions for solid waste management;
  - Snow disposal and plowing plans relative to Wetland Resource Areas;
  - Winter Road Salt and/or Sand Use and Storage restrictions;
  - Street sweeping schedules;
  - Provisions for prevention of illicit discharges to the stormwater management system;
  - Documentation that Stormwater BMPs are designed to provide for shutdown and containment in the event of a spill or discharges to or near critical areas or from LUHPPL;
  - Training for staff or personnel involved with implementing Long-Term Pollution Prevention Plan;
  - List of Emergency contacts for implementing Long-Term Pollution Prevention Plan.
- A Long-Term Pollution Prevention Plan is attached to Stormwater Report and is included as an attachment to the Wetlands Notice of Intent.
  - Treatment BMPs subject to the 44% TSS removal pretreatment requirement and the one inch rule for calculating the water quality volume are included, and discharge:
    - is within the Zone II or Interim Wellhead Protection Area
    - is near or to other critical areas
    - is within soils with a rapid infiltration rate (greater than 2.4 inches per hour)
    - involves runoff from land uses with higher potential pollutant loads.
  - The Required Water Quality Volume is reduced through use of the LID site Design Credits.
  - Calculations documenting that the treatment train meets the 80% TSS removal requirement and, if applicable, the 44% TSS removal pretreatment requirement, are provided.





Massachusetts Department of Environmental Protection  
Bureau of Resource Protection - Wetlands Program

# Checklist for Stormwater Report

## Checklist (continued)

### Standard 4: Water Quality (continued)

- The BMP is sized (and calculations provided) based on:
  - The ½" or 1" Water Quality Volume or
  - The equivalent flow rate associated with the Water Quality Volume and documentation is provided showing that the BMP treats the required water quality volume.
- The applicant proposes to use proprietary BMPs, and documentation supporting use of proprietary BMP and proposed TSS removal rate is provided. This documentation may be in the form of the propriety BMP checklist found in Volume 2, Chapter 4 of the Massachusetts Stormwater Handbook and submitting copies of the TARP Report, STEP Report, and/or other third party studies verifying performance of the proprietary BMPs.
- A TMDL exists that indicates a need to reduce pollutants other than TSS and documentation showing that the BMPs selected are consistent with the TMDL is provided.

### Standard 5: Land Uses With Higher Potential Pollutant Loads (LUHPPLs)

- The NPDES Multi-Sector General Permit covers the land use and the Stormwater Pollution Prevention Plan (SWPPP) has been included with the Stormwater Report.
- The NPDES Multi-Sector General Permit covers the land use and the SWPPP will be submitted **prior to** the discharge of stormwater to the post-construction stormwater BMPs.
- The NPDES Multi-Sector General Permit does **not** cover the land use.
- LUHPPLs are located at the site and industry specific source control and pollution prevention measures have been proposed to reduce or eliminate the exposure of LUHPPLs to rain, snow, snow melt and runoff, and been included in the long term Pollution Prevention Plan.
- All exposure has been eliminated.
- All exposure has **not** been eliminated and all BMPs selected are on MassDEP LUHPPL list.
- The LUHPPL has the potential to generate runoff with moderate to higher concentrations of oil and grease (e.g. all parking lots with >1000 vehicle trips per day) and the treatment train includes an oil grit separator, a filtering bioretention area, a sand filter or equivalent.

### Standard 6: Critical Areas

- The discharge is near or to a critical area and the treatment train includes only BMPs that MassDEP has approved for stormwater discharges to or near that particular class of critical area.
- Critical areas and BMPs are identified in the Stormwater Report.



**Massachusetts Department of Environmental Protection  
Bureau of Resource Protection - Wetlands Program**

# Checklist for Stormwater Report

## Checklist (continued)

### Standard 7: Redevelopments and Other Projects Subject to the Standards only to the maximum extent practicable

- The project is subject to the Stormwater Management Standards only to the maximum Extent Practicable as a:
  - Limited Project
  - Small Residential Projects: 5-9 single family houses or 5-9 units in a multi-family development provided there is no discharge that may potentially affect a critical area.
  - Small Residential Projects: 2-4 single family houses or 2-4 units in a multi-family development with a discharge to a critical area
  - Marina and/or boatyard provided the hull painting, service and maintenance areas are protected from exposure to rain, snow, snow melt and runoff
  - Bike Path and/or Foot Path
  - Redevelopment Project
  - Redevelopment portion of mix of new and redevelopment.
- Certain standards are not fully met (Standard No. 1, 8, 9, and 10 must always be fully met) and an explanation of why these standards are not met is contained in the Stormwater Report.
- The project involves redevelopment and a description of all measures that have been taken to improve existing conditions is provided in the Stormwater Report. The redevelopment checklist found in Volume 2 Chapter 3 of the Massachusetts Stormwater Handbook may be used to document that the proposed stormwater management system (a) complies with Standards 2, 3 and the pretreatment and structural BMP requirements of Standards 4-6 to the maximum extent practicable and (b) improves existing conditions.

### Standard 8: Construction Period Pollution Prevention and Erosion and Sedimentation Control

A Construction Period Pollution Prevention and Erosion and Sedimentation Control Plan must include the following information:

- Narrative;
  - Construction Period Operation and Maintenance Plan;
  - Names of Persons or Entity Responsible for Plan Compliance;
  - Construction Period Pollution Prevention Measures;
  - Erosion and Sedimentation Control Plan Drawings;
  - Detail drawings and specifications for erosion control BMPs, including sizing calculations;
  - Vegetation Planning;
  - Site Development Plan;
  - Construction Sequencing Plan;
  - Sequencing of Erosion and Sedimentation Controls;
  - Operation and Maintenance of Erosion and Sedimentation Controls;
  - Inspection Schedule;
  - Maintenance Schedule;
  - Inspection and Maintenance Log Form.
- A Construction Period Pollution Prevention and Erosion and Sedimentation Control Plan containing the information set forth above has been included in the Stormwater Report.



**Massachusetts Department of Environmental Protection**  
 Bureau of Resource Protection - Wetlands Program

# Checklist for Stormwater Report

## Checklist (continued)

### Standard 8: Construction Period Pollution Prevention and Erosion and Sedimentation Control (continued)

- The project is highly complex and information is included in the Stormwater Report that explains why it is not possible to submit the Construction Period Pollution Prevention and Erosion and Sedimentation Control Plan with the application. A Construction Period Pollution Prevention and Erosion and Sedimentation Control has **not** been included in the Stormwater Report but will be submitted **before** land disturbance begins.
- The project is **not** covered by a NPDES Construction General Permit.
- The project is covered by a NPDES Construction General Permit and a copy of the SWPPP is in the Stormwater Report.
- The project is covered by a NPDES Construction General Permit but no SWPPP been submitted. The SWPPP will be submitted BEFORE land disturbance begins.

### Standard 9: Operation and Maintenance Plan

- The Post Construction Operation and Maintenance Plan is included in the Stormwater Report and includes the following information:
  - Name of the stormwater management system owners;
  - Party responsible for operation and maintenance;
  - Schedule for implementation of routine and non-routine maintenance tasks;
  - Plan showing the location of all stormwater BMPs maintenance access areas;
  - Description and delineation of public safety features;
  - Estimated operation and maintenance budget; and
  - Operation and Maintenance Log Form.
- The responsible party is **not** the owner of the parcel where the BMP is located and the Stormwater Report includes the following submissions:
  - A copy of the legal instrument (deed, homeowner's association, utility trust or other legal entity) that establishes the terms of and legal responsibility for the operation and maintenance of the project site stormwater BMPs;
  - A plan and easement deed that allows site access for the legal entity to operate and maintain BMP functions.

### Standard 10: Prohibition of Illicit Discharges

- The Long-Term Pollution Prevention Plan includes measures to prevent illicit discharges;
- An Illicit Discharge Compliance Statement is attached;
- NO Illicit Discharge Compliance Statement is attached but will be submitted **prior to** the discharge of any stormwater to post-construction BMPs.

## Stormwater Report

Applicant/Project Name: City of Fitchburg

Project Address: City Streets in Fitchburg, Massachusetts including:  
Ashburnham Hill Road  
Caldwell Street  
Arlington Street  
Main Street  
Goddard Street  
Arlington Street  
Haskell Street  
Chestnut Street  
School Street  
Park Street  
Bond Street  
Crescent Heights  
View Street

Application Prepared by:

Firm: Weston & Sampson, Inc.  
Registered PE James Pearson, P.E.

Below is an explanation concerning Standards 1-10 as they apply to the City of Fitchburg's CSO 010 Separation/Rehabilitation Project.

### **General:**

The CSO 010 Separation/Rehabilitation Project includes the separation of an estimated 5,800 linear feet (LF) of combined sewers in the City of Fitchburg, and the elimination of an overflow location (CSO regulator) in the City's combined sewer system that releases untreated combined rainwater and sewage into the North Nashua River during larger rain events.. The closure of this regulator will help to improve the water quality of the North Nashua River and rivers that it is tributary to. The proposed sewer separation throughout the project will result in the installation of approximately 2,650 LF of sanitary sewers and 6,150 LF of new drains, ultimately resulting in the closure of CSO 010. It should be noted that the installation of new sanitary sewers will result in the conversion of existing combined sewers into drains where applicable. The project also includes the separation of 7 combination manholes, many of which have had historical signs of transference between the wastewater and stormwater collection system. Separation of combination manholes showing signs of transference is required under the City's National Pollutant Discharge Elimination System (NPDES) Permit.

The project aims to improve both structural and maintenance related pipe issues that are present in the project area. To complete the necessary system improvements, the project will include 10,300 LF of trenchless rehabilitation to reduce infiltration/inflow upstream of the CSO regulator. Overall, the CSO 010 Separation/Rehabilitation Project will help mitigate many public health issues and environmental concerns in the project area and will help to

improve the effluent quality and treatment capacity of Fitchburg's publicly owned treatment works.

In addition, the project proposes to upsize approximately 40 feet of an existing 12-inch drainage pipe to 24-inches, located in Caldwell Park along Caldwell Street. This drainage pipe outfalls above an existing culvert carrying a mapped perennial stream from Overlook Reservoir north of the project site, flowing south and ultimately outfalling at the Nashua River. The drainage pipe will be replaced in kind with a slightly larger pipe to accommodate two new drainage catch basins installed on Goddard Street. The drainage pipe will enter the existing manhole approximately 4 feet above the existing culvert. Additionally, an existing 24x24 inch box culvert outfall and 12-inch diameter outfall pipe will be abandoned in-place and replaced with a new 60-inch diameter outfall pipe adjacent to the MassDOT bridge on River Street. The existing sewer system was undersized to handle the amount of drainage, which resulted in flooding during severe weather events. As a result, the newly installed drainage system was sized to handle a Year 2070 10-Year, 24-Hour Storm Event to increase the City's climate resiliency.

Overall impervious area on site will decrease, as two sunken plant boxes, two bioretention areas, and one porous pavement section is being added to the site.

#### **Standard 1: No New Untreated Discharges**

There will be no increase in impervious surface; therefore, the project will not result in untreated discharges.

#### **Standard 2: Peak Rate Attenuation**

Since there will be no increase in impervious areas, post-development peak discharge rates will not exceed pre-development peak discharge rates. Additionally, stormwater runoff from the site discharges directly toward a tidal resource area and under this standard peak rate attenuation is not required for such discharges.

To ensure that the work incorporates the performance standards recommended in the DEP's Stormwater Management Policy, necessary erosion and sedimentation control measures will be utilized during construction.

#### **Standard 3: Recharge**

As noted in the **Standard 2** explanation, the impervious area in the work area will not be increased at the completion of the project. Therefore, recharge rates will not change in the work area at the end of the project.

#### **Standard 4: Water Quality**

The proposed work will not change water quality at the site. During the project, appropriate construction practices will be used to minimize sedimentation and soil erosion.

**Standard 5: Land Uses with Higher Potential Pollutant Loads (LUHPPLs)**

Not Applicable. There are no LUHPPLs in the work area.

**Standard 6: Critical Areas**

There will be no new discharge to critical areas.

**Standard 7: Redevelopments and Other Projects Subject to the Standards Only to the Maximum Extent Practicable**

This is a re-development which will minimize disturbance to existing vegetation. All work is within the roadway.

**Standard 8: Construction Period Pollution Prevention and Erosion and Sediment Control**

A detailed Construction Period Pollution Prevention and Erosion and Sedimentation Control Plan is included. To ensure that the work incorporates the performance standards recommended in the DEP's Stormwater Management Policy, necessary erosion and sedimentation control measures will be utilized during construction.

**Standard 9: Operation and Maintenance Plan**

An operations and maintenance plan is not needed since there will not be any new stormwater management systems put in place in the project work area.

**Standard 10: Prohibition of Illicit Discharges**

By the nature of the proposed work, there will be no illicit discharges. There will be no new connections to any MS4 stormwater systems.

Registered Professional Engineer's Certification

I have reviewed the Stormwater Report, including any relevant soil evaluations, computations, Long-term Pollution Prevention Plan, the Construction Period Erosion and Sedimentation Control Plan, the Long-term Post-Construction Operation and Maintenance Plan, the Illicit Discharge Compliance Statement and the plans showing the stormwater management system, and have determined that they have been prepared in accordance with the requirements of the Stormwater Management Standards as further elaborated by the Massachusetts Stormwater Handbook. I have also determined that the information presented in the Stormwater Checklist is accurate and that the information presented in the Stormwater Report accurately reflects conditions at the site as of the date of this permit application.

Registered Professional Engineer Block and Signature

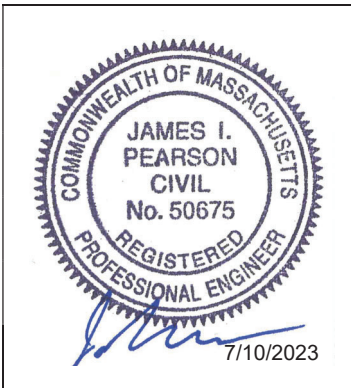

 7/10/2023  
Signature and Date

## Construction Period Pollution Prevention and Erosion and Sedimentation Control Plan

### SECTION 1: Introduction

The Combined Sewer Overflow (CSO) 010 Separation/Rehabilitation Project has the primary objective of separating combined sewers, closing one CSO regulator, and improving the wastewater collection system within the project area. This project will improve the water quality in the North Nashua River and better the public health of the City of Fitchburg and surrounding communities. It will also help to mitigate infiltration and inflow (I/I), improve deteriorating infrastructure, and improve capacity of the collection system within the project area to more effectively manage wastewater and stormwater flows.

CSOs have contributed to poor water quality in the North Nashua River, effectively impairing the water body for Escherichia coli (E. coli) and chronic aquatic toxicity and limiting its recreational usages. Furthermore, downstream of Fitchburg the Nashua River is impaired for phosphorus, E. coli, freshwater acute toxicity, and odor. The CSO 010 Separation/Rehabilitation Project addresses these issues through the elimination of untreated combined sewage overflows from CSO regulator 010. As part of this project, this "Construction Period Pollution Prevention and Erosion and Sedimentation Control Plan" has been created to ensure that no further disturbance to the wetland resource is created during the project.

### SECTION 2: Construction Period Pollution Prevention Measures

Best Management Practices (BMPs) will be utilized as Construction Period Pollution Prevention Measures to reduce potential pollutants and prevent any off-site discharge. The objectives of the BMPs for construction activity are to minimize the disturbed areas, stabilize any disturbed areas, control the site perimeter and retain sediment. Both erosion and sedimentation controls and non-stormwater best management measures will be used to minimize site disturbance and ensure compliance with the performance standards of the WPA and Stormwater Standards. Measures will be taken to minimize the area disturbed by construction activities to reduce the potential for soil erosion and stormwater pollution problems. In addition, good housekeeping measures will be followed for the day-to-day operation of the construction site under the control of the contractor to minimize the impact of construction. This section describes the control practices that will be in place during construction activities. Recommended control practices will comply with the standards set in the MA DEP Stormwater Policy Handbook.

#### **2.1 Minimize Disturbed Area and Protect Natural Features and Soil**

In order to minimize disturbed areas, work will be completed within well-defined work limits. These work limits are shown on the construction plans. The Contractor shall not disturb native vegetation in the undisturbed wetland area without prior approval from the Engineer. The Contractor will be responsible to make sure that all of their workers and any subcontractors know the proper work limits and do not extend their work into the undisturbed areas. The protective measures are described in more detail in the following sections.



## **2.2 Control Stormwater Flowing onto and through the project**

Construction areas adjacent to wetland resources will be lined with appropriate sediment and erosion control measures. Erosion controls will be inspected daily for sediment build-up and accumulated silt will be removed as needed.

## **2.3 Stabilize Soils**

The Contractor shall limit the area of land which is exposed and free from vegetation during construction. In areas where the period of exposure will be greater than two (2) months, mulching, the use of erosion control mats, or other protective measures shall be provided as specified.

The Contractor shall take account of the conditions of the soil where erosion control seeding will take place to ensure that materials used for re-vegetation are adaptive to sediment control.

## **2.4 Proper Storage and Cover of Any Stockpiles**

The location of the Contractor's storage areas for equipment and/or materials shall require written approval of the Engineer.

There shall be no storage of equipment or materials in areas designated as wetlands.

The Engineer may designate a particular area or areas where the Contractor may store materials used in his operations.

## **2.5 Perimeter Controls and Sediment Barriers**

Erosion control lines as described in Section 5 will be utilized to ensure that sedimentation does not occur outside the perimeter of the work area.

## **2.6 Storm Drain Inlet Protection**

Storm drain inlet protection will be installed within the work area.

## **2.7 Retain Sediment On-Site**

The Contractor will be responsible for monitoring erosion control measures. Whenever necessary the Contractor will clear sediment from the erosion control that has been silted up during construction. Daily monitoring should be conducted using the attached Monitoring Form.

## **2.8 Material Handling and Waste Management**

Materials stored on-site will be stored in a neat, orderly manner in appropriate containers. Materials will be kept in their original containers with the original manufacturer's label. Substances will not be mixed with one another unless recommended by the manufacturer.

Waste materials will be collected and stored in a securely lidded metal container from a licensed management company. The waste and any construction debris from the site will be hauled off-site daily and disposed of properly. The contractor will be responsible for waste removal. Manufacturer's

recommendations for proper use and disposal will be followed for materials. Sanitary waste will be collected from the portable units a minimum of once a week, by a licensed sanitary waste management contractor.

## **2.9 Designated Washout Areas**

The Contractor shall use washout facilities at their own facilities, unless otherwise directed by the Engineer.

## **2.10 Proper Equipment/Vehicle Fueling and Maintenance Practices**

On-site vehicles will be monitored for leaks and receive regular preventative maintenance to reduce the risk of leakage. To ensure that leaks on stored equipment do not contaminate the site, oil-absorbing mats will be placed under oil-containing equipment during storage. Regular fueling and service of the equipment may be performed using approved methods and with care taken to minimize the chance of spills. Repair of equipment or machinery within the 100' water resources area shall not be allowed without the prior approval of the Engineer. Any petroleum products will be stored in tightly sealed containers that are clearly labeled with spill control pads/socks placed under/around their perimeters.

## **2.11 Equipment/Vehicle Washing**

The Contractor will be responsible to ensure that no equipment is washed on-site.

## **SECTION 3: Spill Prevention and Control Plan**

The Contractor will be responsible for preventing spills in accordance with the project specifications and applicable federal, state and local regulations. The Contractor will identify a properly trained site employee, involved with the day-to-day site operations to be the spill prevention and cleanup coordinator. The name(s) of the responsible spill personnel will be posted on-site. Each employee will be instructed that all spills are to be reported to the spill prevention and cleanup coordinator.

## **3.1 Spill Control Equipment**

Spill control/containment equipment will be kept in the Work Area. Materials and equipment necessary for spill cleanup will be kept either in the Work Area or in an otherwise accessible on-site location. Equipment and materials will include, but not be limited to, absorbent booms/mats, brooms, dust pans, mops, rags, gloves, goggles, sand, plastic and metal containers specifically for this purpose. It is the responsibility of the Contractor to ensure the inventory will be readily accessible and maintained.

## **3.2 Notification**

Workers will be directed to inform the on-site supervisor of a spill event. The supervisor will assess the incident and initiate proper containment and response procedures immediately upon notification. Workers should avoid direct contact with spilled materials during the containment procedures. Primary notification of a spill should be made to the local Fire Department and Police Departments. Secondary Notification will be to the certified cleanup contractor if deemed necessary by Fire and/or Police personnel. The third level of notification (within 1 hour) is to the DEP or municipality's Licensed

Site Professional (LSP). The specific cleanup contractor to be used will be identified by the Contractor prior to commencement of construction activities.

### **3.3 Spill Containment and Clean-Up Measures**

Spills will be contained with granular sorbent material, sand, sorbent pads, booms, or all of the above to prevent spreading. Certified cleanup contractors should complete spill cleanup. The material manufacturer's recommended methods for spill cleanup will be clearly posted and on-site personnel will be made aware of the procedures and the location of the information and cleanup supplies.

### **3.4 Hazardous Materials Spill Report**

The Contractor will report and record any spill. The spill report will present a description of the release, including the quantity and type of material, date of the spill, circumstances leading to the release, location of spill, response actions and personnel, documentation of notifications and corrective measures implemented to prevent reoccurrence.

This document does not relieve the Contractor of the Federal reporting requirements of 40 CFR Part 110, 40 CFR Part 117, 40 CFR Part 302 and the State requirements specified under the Massachusetts Contingency Plan (M.C.P) relating to spills or other releases of oils or hazardous substances. Where a release containing a hazardous substance or oil in an amount equal to or in excess of a reportable quantity established under either 40 CFR Part 110, 40 CFR Part 117 or 40 CFR Part 302, occurs during a twenty-four (24) hour period, the Contractor is required to comply with the response requirements of the above mentioned regulations. Spills of oil or hazardous material in excess of the reportable quantity will be reported to the National Response Center (NRC).

## SECTION 4: Contact Information/Responsible Parties

### **Owner/Operator:**

City of Fitchburg  
Ken Dupont  
301 Broad Street  
Fitchburg, MA 01420  
978-829-1906

### **Engineer:**

James Pearson, PE  
Weston & Sampson Engineers, Inc.  
55 Walkers Brook Drive, Suite 100  
Reading, MA 01867  
978-532-1900

### **Site Inspector:**

TBD

### **Contractor:**

TBD

SECTION 5: Erosion and Sedimentation Control

Erosion and Sedimentation Control Drawings can be found in the attached project plans

SECTION 6: Site Development Plan

The Site Development Plan is included in the attached plans.

SECTION 7: Operation and Maintenance of Erosion Control

The erosion control measures will be installed as detailed in the technical specifications. If there is a failure to the controls the Contractor, under the supervision of the Engineer, will be required to stop work until the failure is repaired.

Periodically throughout the work, whenever the Engineer deems it necessary, the sediment that has been deposited against the controls will be removed to ensure that the controls are working properly.

SECTION 8: Inspection Schedule

During construction, the erosion and sedimentation controls will be inspected daily. Once the Contractor is selected, an onsite inspector will be selected to work closely with the Engineer to ensure that erosion and sedimentation controls are in place and working properly. An Inspection Form is included.

**Construction Period Pollution Prevention and Erosion and Sedimentation Control Plan**

CSO 010 Separation/Rehabilitation Project

Inspection Form

Inspected By: \_\_\_\_\_ Date: \_\_\_\_\_ Time: \_\_\_\_\_

| YES | NO | DOES NOT APPLY | ITEM   |
|-----|----|----------------|--|
|     |    |                | Do any erosion/siltation control measures require repair or clean out to maintain adequate function?   |
|     |    |                | Is there any evidence that sediment is leaving the site and entering the wetlands?   |
|     |    |                | Are any temporary soil stockpiles or construction materials located in non-approved areas?   |
|     |    |                | Are on-site construction traffic routes, parking, and storage of equipment and supplies located in areas not specifically designed for them? |

Specific location, current weather conditions, and action to be taken:

\_\_\_\_\_

\_\_\_\_\_

\_\_\_\_\_

\_\_\_\_\_

Other Comments:

\_\_\_\_\_

\_\_\_\_\_

Pending the actions noted above I certify that the site is in compliance with the Construction Period Pollution Prevention and Erosion and Sedimentation Control Plan.

Signature: \_\_\_\_\_ Date: \_\_\_\_\_

***Weston & Sampson***

THIS PAGE INTENTIONALLY LEFT BLANK

DOCUMENT A00861

**MASSACHUSETTS**

**DEPARTMENT OF ENVIRONMENTAL PROTECTION**

**ORDER OF CONDITIONS**

THIS PAGE INTENTIONALLY LEFT BLANK





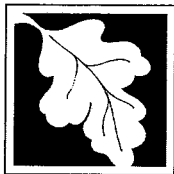

**Massachusetts Department of Environmental Protection**  
 Bureau of Resource Protection - Wetlands  
**WPA Form 5 – Order of Conditions**  
 Massachusetts Wetlands Protection Act M.G.L. c. 131, §40

Provided by MassDEP:  
 155 - 731  
 MassDEP File #

eDEP Transaction #  
**FITCHBURG**  
 City/Town

**A. General Information (cont.)**

6. Property recorded at the Registry of Deeds for (attach additional information if more than one parcel):  
Worcester North  
 a. County \_\_\_\_\_ b. Certificate Number (if registered land) \_\_\_\_\_  
 c. Book \_\_\_\_\_ d. Page \_\_\_\_\_
7. Dates: 07/23/2023 08/02/2023 08/02/2023  
 a. Date Notice of Intent Filed b. Date Public Hearing Closed c. Date of Issuance
8. Final Approved Plans and Other Documents (attach additional plan or document references as needed):  
Plan of River Street Bridge Replacement, Fitchburg , Mass. Prepared for MassDOT  
Highway Division  
STV Incorporated and C&C Consulting  
Engineers LLC  
06/28/2023  
 d. Final Revision Date c. Signed and Stamped by \_\_\_\_\_  
 e. Scale 1" = 20'
- f. Additional Plan or Document Title \_\_\_\_\_ g. Date \_\_\_\_\_

**B. Findings**

1. Findings pursuant to the Massachusetts Wetlands Protection Act:  
 Following the review of the above-referenced Notice of Intent and based on the information provided in this application and presented at the public hearing, this Commission finds that the areas in which work is proposed is significant to the following interests of the Wetlands Protection Act (the Act). Check all that apply:
- a.  Public Water Supply    b.  Land Containing Shellfish    c.  Prevention of Pollution  
 d.  Private Water Supply    e.  Fisheries    f.  Protection of Wildlife Habitat  
 g.  Groundwater Supply    h.  Storm Damage Prevention    i.  Flood Control
2. This Commission hereby finds the project, as proposed, is: (check one of the following boxes)

**Approved subject to:**

- a.  the following conditions which are necessary in accordance with the performance standards set forth in the wetlands regulations. This Commission orders that all work shall be performed in accordance with the Notice of Intent referenced above, the following General Conditions, and any other special conditions attached to this Order. To the extent that the following conditions modify or differ from the plans, specifications, or other proposals submitted with the Notice of Intent, these conditions shall control.

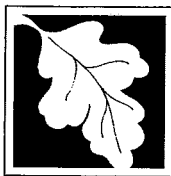

**Massachusetts Department of Environmental Protection**  
**Bureau of Resource Protection - Wetlands**  
**WPA Form 5 – Order of Conditions**  
 Massachusetts Wetlands Protection Act M.G.L. c. 131, §40

Provided by MassDEP:  
 155 - 731  
 MassDEP File #

eDEP Transaction #  
**FITCHBURG**  
 City/Town

**B. Findings (cont.)**

Denied because:

- b.  the proposed work cannot be conditioned to meet the performance standards set forth in the wetland regulations. Therefore, work on this project may not go forward unless and until a new Notice of Intent is submitted which provides measures which are adequate to protect the interests of the Act, and a final Order of Conditions is issued. **A description of the performance standards which the proposed work cannot meet is attached to this Order.**
- c.  the information submitted by the applicant is not sufficient to describe the site, the work, or the effect of the work on the interests identified in the Wetlands Protection Act. Therefore, work on this project may not go forward unless and until a revised Notice of Intent is submitted which provides sufficient information and includes measures which are adequate to protect the Act's interests, and a final Order of Conditions is issued. **A description of the specific information which is lacking and why it is necessary is attached to this Order as per 310 CMR 10.05(6)(c).**
- 3.  Buffer Zone Impacts: Shortest distance between limit of project disturbance and the wetland resource area specified in 310 CMR 10.02(1)(a) 1,341  
 a. linear feet

**Inland Resource Area Impacts:** Check all that apply below. (For Approvals Only)

| Resource Area   | Proposed Alteration  | Permitted Alteration                                     | Proposed Replacement                | Permitted Replacement               |
|---|--|--|-------------------------------------|-------------------------------------|
| 4. <input checked="" type="checkbox"/> Bank                                 | <u>30</u><br>a. linear feet                                | <u>0</u><br>b. linear feet                               | <u>          </u><br>c. linear feet | <u>          </u><br>d. linear feet |
| 5. <input type="checkbox"/> Bordering Vegetated Wetland                     | <u>          </u><br>a. square feet                        | <u>          </u><br>b. square feet                      | <u>          </u><br>c. square feet | <u>          </u><br>d. square feet |
| 6. <input checked="" type="checkbox"/> Land Under Waterbodies and Waterways | <u>150</u><br>a. square feet<br><u>0</u><br>e. c/y dredged | <u>0</u><br>b. square feet<br><u>0</u><br>f. c/y dredged | <u>          </u><br>c. square feet | <u>          </u><br>d. square feet |
| 7. <input checked="" type="checkbox"/> Bordering Land Subject to Flooding   | <u>150</u><br>a. square feet                               | <u>0</u><br>b. square feet                               | <u>          </u><br>c. square feet | <u>          </u><br>d. square feet |
| Cubic Feet Flood Storage  | <u>          </u><br>e. cubic feet                         | <u>          </u><br>f. cubic feet                       | <u>          </u><br>g. cubic feet  | <u>          </u><br>h. cubic feet  |
| 8. <input type="checkbox"/> Isolated Land Subject to Flooding               | <u>          </u><br>a. square feet                        | <u>          </u><br>b. square feet                      |                                     |                                     |
| Cubic Feet Flood Storage  | <u>          </u><br>c. cubic feet                         | <u>          </u><br>d. cubic feet                       | <u>          </u><br>e. cubic feet  | <u>          </u><br>f. cubic feet  |
| 9. <input checked="" type="checkbox"/> Riverfront Area                      | <u>1,341</u><br>a. total sq. feet                          | <u>200</u><br>b. total sq. feet                          |                                     |                                     |
| Sq ft within 100 ft   | <u>          </u><br>c. square feet                        | <u>          </u><br>d. square feet                      | <u>0</u><br>e. square feet          | <u>0</u><br>f. square feet          |
| Sq ft between 100-200 ft  | <u>1,341</u><br>g. square feet                             | <u>200</u><br>h. square feet                             | <u>0</u><br>i. square feet          | <u>0</u><br>j. square feet          |

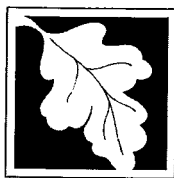

**Massachusetts Department of Environmental Protection**  
 Bureau of Resource Protection - Wetlands  
**WPA Form 5 – Order of Conditions**  
 Massachusetts Wetlands Protection Act M.G.L. c. 131, §40

Provided by MassDEP:  
 155 - 731  
 MassDEP File #

eDEP Transaction #  
**FITCHBURG**  
 City/Town

**B. Findings (cont.)**

**Coastal Resource Area Impacts:** Check all that apply below. (For Approvals Only)

- |  | Proposed<br>Alteration  | Permitted<br>Alteration | Proposed<br>Replacement | Permitted<br>Replacement |
|--|---|-------------------------|-------------------------|--------------------------|
| 10. <input type="checkbox"/> Designated Port Areas                 | Indicate size under Land Under the Ocean, below   |                         |                         |                          |
| 11. <input type="checkbox"/> Land Under the Ocean                  | _____   | _____                   |                         |                          |
|  | a. square feet  | b. square feet          |                         |                          |
|  | _____   | _____                   |                         |                          |
|  | c. c/y dredged  | d. c/y dredged          |                         |                          |
| 12. <input type="checkbox"/> Barrier Beaches                       | Indicate size under Coastal Beaches and/or Coastal Dunes below  |                         |                         |                          |
| 13. <input type="checkbox"/> Coastal Beaches                       | _____   | _____                   | _____ cu yd             | _____ cu yd              |
|  | a. square feet  | b. square feet          | c. nourishment          | d. nourishment           |
| 14. <input type="checkbox"/> Coastal Dunes                         | _____   | _____                   | _____ cu yd             | _____ cu yd              |
|  | a. square feet  | b. square feet          | c. nourishment          | d. nourishment           |
| 15. <input type="checkbox"/> Coastal Banks                         | _____   | _____                   |                         |                          |
|  | a. linear feet  | b. linear feet          |                         |                          |
| 16. <input type="checkbox"/> Rocky Intertidal Shores               | _____   | _____                   |                         |                          |
|  | a. square feet  | b. square feet          |                         |                          |
| 17. <input type="checkbox"/> Salt Marshes                          | _____   | _____                   | _____                   | _____                    |
|  | a. square feet  | b. square feet          | c. square feet          | d. square feet           |
| 18. <input type="checkbox"/> Land Under Salt Ponds                 | _____   | _____                   |                         |                          |
|  | a. square feet  | b. square feet          |                         |                          |
|  | _____   | _____                   |                         |                          |
|  | c. c/y dredged  | d. c/y dredged          |                         |                          |
| 19. <input type="checkbox"/> Land Containing Shellfish             | _____   | _____                   | _____                   | _____                    |
|  | a. square feet  | b. square feet          | c. square feet          | d. square feet           |
| 20. <input type="checkbox"/> Fish Runs                             | Indicate size under Coastal Banks, Inland Bank, Land Under the Ocean, and/or inland Land Under Waterbodies and Waterways, above |                         |                         |                          |
|  | _____   | _____                   |                         |                          |
|  | a. c/y dredged  | b. c/y dredged          |                         |                          |
| 21. <input type="checkbox"/> Land Subject to Coastal Storm Flowage | _____   | _____                   |                         |                          |
|  | a. square feet  | b. square feet          |                         |                          |

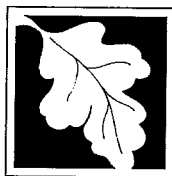

Massachusetts Department of Environmental Protection  
Bureau of Resource Protection - Wetlands  
**WPA Form 5 – Order of Conditions**  
Massachusetts Wetlands Protection Act M.G.L. c. 131, §40

Provided by MassDEP:  
155 - 731  
MassDEP File #

eDEP Transaction #  
**FITCHBURG**  
City/Town

**B. Findings (cont.)**

\* #22. If the project is for the purpose of restoring or enhancing a wetland resource area in addition to the square footage that has been entered in Section B.5.c (BVW) or B.17.c (Salt Marsh) above, please enter the additional amount here.

22.  Restoration/Enhancement \*:

a. square feet of BVW

b. square feet of salt marsh

23.  Stream Crossing(s):

a. number of new stream crossings

b. number of replacement stream crossings

**C. General Conditions Under Massachusetts Wetlands Protection Act**

The following conditions are only applicable to Approved projects.

1. Failure to comply with all conditions stated herein, and with all related statutes and other regulatory measures, shall be deemed cause to revoke or modify this Order.
2. The Order does not grant any property rights or any exclusive privileges; it does not authorize any injury to private property or invasion of private rights.
3. This Order does not relieve the permittee or any other person of the necessity of complying with all other applicable federal, state, or local statutes, ordinances, bylaws, or regulations.
4. The work authorized hereunder shall be completed within three years from the date of this Order unless either of the following apply:
  - a. the work is a maintenance dredging project as provided for in the Act; or
  - b. the time for completion has been extended to a specified date more than three years, but less than five years, from the date of issuance. If this Order is intended to be valid for more than three years, the extension date and the special circumstances warranting the extended time period are set forth as a special condition in this Order.
5. This Order may be extended by the issuing authority for one or more periods of up to three years each upon application to the issuing authority at least 30 days prior to the expiration date of the Order.
6. If this Order constitutes an Amended Order of Conditions, this Amended Order of Conditions does not extend the issuance date of the original Final Order of Conditions and the Order will expire on \_\_\_\_\_ unless extended in writing by the Department.
7. Any fill used in connection with this project shall be clean fill. Any fill shall contain no trash, refuse, rubbish, or debris, including but not limited to lumber, bricks, plaster, wire, lath, paper, cardboard, pipe, tires, ashes, refrigerators, motor vehicles, or parts of any of the foregoing.
8. This Order is not final until all administrative appeal periods from this Order have elapsed, or if such an appeal has been taken, until all proceedings before the Department have been completed.



**Massachusetts Department of Environmental Protection**  
Bureau of Resource Protection - Wetlands  
**WPA Form 5 – Order of Conditions**  
Massachusetts Wetlands Protection Act M.G.L. c. 131, §40

Provided by MassDEP:  
155 - 731  
MassDEP File #

eDEP Transaction #  
FITCHBURG  
City/Town

**C. General Conditions Under Massachusetts Wetlands Protection Act (cont.)**

9. No work shall be undertaken until the Order has become final and then has been recorded in the Registry of Deeds or the Land Court for the district in which the land is located, within the chain of title of the affected property. In the case of recorded land, the Final Order shall also be noted in the Registry's Grantor Index under the name of the owner of the land upon which the proposed work is to be done. In the case of the registered land, the Final Order shall also be noted on the Land Court Certificate of Title of the owner of the land upon which the proposed work is done. The recording information shall be submitted to the Conservation Commission on the form at the end of this Order, which form must be stamped by the Registry of Deeds, prior to the commencement of work.
10. A sign shall be displayed at the site not less than two square feet or more than three square feet in size bearing the words,  

"Massachusetts Department of Environmental Protection" [or, "MassDEP"]  
"File Number            155 - 731 "
11. Where the Department of Environmental Protection is requested to issue a Superseding Order, the Conservation Commission shall be a party to all agency proceedings and hearings before MassDEP.
12. Upon completion of the work described herein, the applicant shall submit a Request for Certificate of Compliance (WPA Form 8A) to the Conservation Commission.
13. The work shall conform to the plans and special conditions referenced in this order.
14. Any change to the plans identified in Condition #13 above shall require the applicant to inquire of the Conservation Commission in writing whether the change is significant enough to require the filing of a new Notice of Intent.
15. The Agent or members of the Conservation Commission and the Department of Environmental Protection shall have the right to enter and inspect the area subject to this Order at reasonable hours to evaluate compliance with the conditions stated in this Order, and may require the submittal of any data deemed necessary by the Conservation Commission or Department for that evaluation.
16. This Order of Conditions shall apply to any successor in interest or successor in control of the property subject to this Order and to any contractor or other person performing work conditioned by this Order.
17. Prior to the start of work, and if the project involves work adjacent to a Bordering Vegetated Wetland, the boundary of the wetland in the vicinity of the proposed work area shall be marked by wooden stakes or flagging. Once in place, the wetland boundary markers shall be maintained until a Certificate of Compliance has been issued by the Conservation Commission.



Massachusetts Department of Environmental Protection  
Bureau of Resource Protection - Wetlands

**WPA Form 5 – Order of Conditions**

Massachusetts Wetlands Protection Act M.G.L. c. 131, §40

Provided by MassDEP:  
155 - 731  
MassDEP File #

eDEP Transaction #  
FITCHBURG  
City/Town

**C. General Conditions Under Massachusetts Wetlands Protection Act (cont.)**

- 18. All sedimentation barriers shall be maintained in good repair until all disturbed areas have been fully stabilized with vegetation or other means. At no time shall sediments be deposited in a wetland or water body. During construction, the applicant or his/her designee shall inspect the erosion controls on a daily basis and shall remove accumulated sediments as needed. The applicant shall immediately control any erosion problems that occur at the site and shall also immediately notify the Conservation Commission, which reserves the right to require additional erosion and/or damage prevention controls it may deem necessary. Sedimentation barriers shall serve as the limit of work unless another limit of work line has been approved by this Order.

**NOTICE OF STORMWATER CONTROL AND MAINTENANCE REQUIREMENTS**

- 19. **The work associated with this Order (the "Project") is (1)  is not (2)  subject to the Massachusetts Stormwater Standards. If the work is subject to the Stormwater Standards, then the project is subject to the following conditions:**

- a) All work, including site preparation, land disturbance, construction and redevelopment, shall be implemented in accordance with the construction period pollution prevention and erosion and sedimentation control plan and, if applicable, the Stormwater Pollution Prevention Plan required by the National Pollution Discharge Elimination System Construction General Permit as required by Stormwater Condition 8. Construction period erosion, sedimentation and pollution control measures and best management practices (BMPs) shall remain in place until the site is fully stabilized.

- b) No stormwater runoff may be discharged to the post-construction stormwater BMPs unless and until a Registered Professional Engineer provides a Certification that:
  - i. all construction period BMPs have been removed or will be removed by a date certain specified in the Certification. For any construction period BMPs intended to be converted to post construction operation for stormwater attenuation, recharge, and/or treatment, the conversion is allowed by the MassDEP Stormwater Handbook BMP specifications and that the BMP has been properly cleaned or prepared for post construction operation, including removal of all construction period sediment trapped in inlet and outlet control structures;
  - ii. as-built final construction BMP plans are included, signed and stamped by a Registered Professional Engineer, certifying the site is fully stabilized;
  - iii. any illicit discharges to the stormwater management system have been removed, as per the requirements of Stormwater Standard 10;
  - iv. all post-construction stormwater BMPs are installed in accordance with the plans (including all planting plans) approved by the issuing authority, and have been inspected to ensure that they are not damaged and that they are in proper working condition;
  - v. any vegetation associated with post-construction BMPs is suitably established to withstand erosion.



**Massachusetts Department of Environmental Protection**  
 Bureau of Resource Protection - Wetlands

**WPA Form 5 – Order of Conditions**

Massachusetts Wetlands Protection Act M.G.L. c. 131, §40

Provided by MassDEP:

155 - 731

MassDEP File #

eDEP Transaction #

FITCHBURG

City/Town

**C. General Conditions Under Massachusetts Wetlands Protection Act (cont.)**

c) The landowner is responsible for BMP maintenance until the issuing authority is notified that another party has legally assumed responsibility for BMP maintenance. Prior to requesting a Certificate of Compliance, or Partial Certificate of Compliance, the responsible party (defined in General Condition 18(e)) shall execute and submit to the issuing authority an Operation and Maintenance Compliance Statement ("O&M Statement) for the Stormwater BMPs identifying the party responsible for implementing the stormwater BMP Operation and Maintenance Plan ("O&M Plan") and certifying the following: *i.*) the O&M Plan is complete and will be implemented upon receipt of the Certificate of Compliance, and *ii.*) the future responsible parties shall be notified in writing of their ongoing legal responsibility to operate and maintain the stormwater management BMPs and implement the Stormwater Pollution Prevention Plan.

d) Post-construction pollution prevention and source control shall be implemented in accordance with the long-term pollution prevention plan section of the approved Stormwater Report and, if applicable, the Stormwater Pollution Prevention Plan required by the National Pollution Discharge Elimination System Multi-Sector General Permit.

e) Unless and until another party accepts responsibility, the landowner, or owner of any drainage easement, assumes responsibility for maintaining each BMP. To overcome this presumption, the landowner of the property must submit to the issuing authority a legally binding agreement of record, acceptable to the issuing authority, evidencing that another entity has accepted responsibility for maintaining the BMP, and that the proposed responsible party shall be treated as a permittee for purposes of implementing the requirements of Conditions 18(f) through 18(k) with respect to that BMP. Any failure of the proposed responsible party to implement the requirements of Conditions 18(f) through 18(k) with respect to that BMP shall be a violation of the Order of Conditions or Certificate of Compliance. In the case of stormwater BMPs that are serving more than one lot, the legally binding agreement shall also identify the lots that will be serviced by the stormwater BMPs. A plan and easement deed that grants the responsible party access to perform the required operation and maintenance must be submitted along with the legally binding agreement.

f) The responsible party shall operate and maintain all stormwater BMPs in accordance with the design plans, the O&M Plan, and the requirements of the Massachusetts Stormwater Handbook.



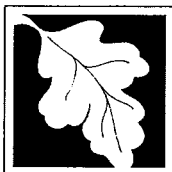

Massachusetts Department of Environmental Protection  
Bureau of Resource Protection - Wetlands

**WPA Form 5 – Order of Conditions**

Massachusetts Wetlands Protection Act M.G.L. c. 131, §40

Provided by MassDEP:  
155 - 731

MassDEP File #

eDEP Transaction #

FITCHBURG

City/Town

**C. General Conditions Under Massachusetts Wetlands Protection Act (cont.)**

- g) The responsible party shall:
  1. Maintain an operation and maintenance log for the last three (3) consecutive calendar years of inspections, repairs, maintenance and/or replacement of the stormwater management system or any part thereof, and disposal (for disposal the log shall indicate the type of material and the disposal location);
  2. Make the maintenance log available to MassDEP and the Conservation Commission ("Commission") upon request; and
  3. Allow members and agents of the MassDEP and the Commission to enter and inspect the site to evaluate and ensure that the responsible party is in compliance with the requirements for each BMP established in the O&M Plan approved by the issuing authority.
  
- h) All sediment or other contaminants removed from stormwater BMPs shall be disposed of in accordance with all applicable federal, state, and local laws and regulations.
- i) Illicit discharges to the stormwater management system as defined in 310 CMR 10.04 are prohibited.
- j) The stormwater management system approved in the Order of Conditions shall not be changed without the prior written approval of the issuing authority.
- k) Areas designated as qualifying pervious areas for the purpose of the Low Impact Site Design Credit (as defined in the MassDEP Stormwater Handbook, Volume 3, Chapter 1, Low Impact Development Site Design Credits) shall not be altered without the prior written approval of the issuing authority.
- l) Access for maintenance, repair, and/or replacement of BMPs shall not be withheld. Any fencing constructed around stormwater BMPs shall include access gates and shall be at least six inches above grade to allow for wildlife passage.

Special Conditions (if you need more space for additional conditions, please attach a text document):

**SEE ATTACHED SPECIAL CONDITIONS**

---



---



---



---



**Massachusetts Department of Environmental Protection**  
**Bureau of Resource Protection - Wetlands**  
**WPA Form 5 – Order of Conditions**  
Massachusetts Wetlands Protection Act M.G.L. c. 131, §40

Provided by MassDEP:  
155 - 731  
MassDEP File #

eDEP Transaction #  
**FITCHBURG**  
City/Town

**D. Findings Under Municipal Wetlands Bylaw or Ordinance**

- 1. Is a municipal wetlands bylaw or ordinance applicable?  Yes  No
- 2. The FITCHBURG hereby finds (check one that applies):  
Conservation Commission
  - a.  that the proposed work cannot be conditioned to meet the standards set forth in a municipal ordinance or bylaw, specifically:

1. Municipal Ordinance or Bylaw \_\_\_\_\_ 2. Citation \_\_\_\_\_

Therefore, work on this project may not go forward unless and until a revised Notice of Intent is submitted which provides measures which are adequate to meet these standards, and a final Order of Conditions is issued.

- b.  that the following additional conditions are necessary to comply with a municipal ordinance or bylaw:

Fitchburg Wetlands Protection Ordinance  
1. Municipal Ordinance or Bylaw \_\_\_\_\_ 2. Citation \_\_\_\_\_

- 3. The Commission orders that all work shall be performed in accordance with the following conditions and with the Notice of Intent referenced above. To the extent that the following conditions modify or differ from the plans, specifications, or other proposals submitted with the Notice of Intent, the conditions shall control.

The special conditions relating to municipal ordinance or bylaw are as follows (if you need more space for additional conditions, attach a text document):

---



---



---



---



**Massachusetts Department of Environmental Protection**  
 Bureau of Resource Protection - Wetlands  
**WPA Form 5 – Order of Conditions**  
 Massachusetts Wetlands Protection Act M.G.L. c. 131, §40

Provided by MassDEP:

MassDEP File # \_\_\_\_\_

eDEP Transaction # \_\_\_\_\_

City/Town \_\_\_\_\_

**E. Signatures**

This Order is valid for three years, unless otherwise specified as a special condition pursuant to General Conditions #4, from the date of issuance.

08-02-2023

1. Date of Issuance

Please indicate the number of members who will sign this form.

4

This Order must be signed by a majority of the Conservation Commission.

2. Number of Signers

The Order must be mailed by certified mail (return receipt requested) or hand delivered to the applicant. A copy also must be mailed or hand delivered at the same time to the appropriate Department of Environmental Protection Regional Office, if not filing electronically, and the property owner, if different from applicant.

Signature \_\_\_\_\_

Printed Name \_\_\_\_\_

Signature \_\_\_\_\_

Printed Name \_\_\_\_\_

Signature \_\_\_\_\_

Printed Name \_\_\_\_\_

Signature \_\_\_\_\_

Printed Name \_\_\_\_\_

Signature \_\_\_\_\_

Printed Name \_\_\_\_\_

Signature \_\_\_\_\_

Printed Name \_\_\_\_\_

Signature \_\_\_\_\_

Printed Name \_\_\_\_\_

Signature \_\_\_\_\_

Printed Name \_\_\_\_\_

by hand delivery on

by certified mail, return receipt requested, on

Date \_\_\_\_\_

Date \_\_\_\_\_



Massachusetts Department of Environmental Protection  
Bureau of Resource Protection - Wetlands

**WPA Form 5 – Order of Conditions**

Massachusetts Wetlands Protection Act M.G.L. c. 131, §40

Provided by MassDEP:

155 - 731

MassDEP File #

eDEP Transaction #

FITCHBURG

City/Town

**G. Recording Information**

Prior to commencement of work, this Order of Conditions must be recorded in the Registry of Deeds or the Land Court for the district in which the land is located, within the chain of title of the affected property. In the case of recorded land, the Final Order shall also be noted in the Registry's Grantor Index under the name of the owner of the land subject to the Order. In the case of registered land, this Order shall also be noted on the Land Court Certificate of Title of the owner of the land subject to the Order of Conditions. The recording information on this page shall be submitted to the Conservation Commission listed below.

Fitchburg

Conservation Commission

Detach on dotted line, have stamped by the Registry of Deeds and submit to the Conservation Commission.

To:

Fitchburg

Conservation Commission

Please be advised that the Order of Conditions for the Project at:

0 Main St

Project Location

155-731

MassDEP File Number

Has been recorded at the Registry of Deeds of:

Worcester North

County

10625

Book

172

Page

for: Massachusetts Department of Transportation- Highway Division  
Property Owner

and has been noted in the chain of title of the affected property in:

10590

Book

205

Page

In accordance with the Order of Conditions issued on:

8-2-2023

Date

If recorded land, the instrument number identifying this transaction is:

Instrument Number

If registered land, the document number identifying this transaction is:

Document Number

Signature of Applicant



**Massachusetts Department of Environmental Protection**  
 Bureau of Resource Protection - Wetlands  
**WPA Form 5 – Order of Conditions**  
 Massachusetts Wetlands Protection Act M.G.L. c. 131, §40

Provided by MassDEP:

\_\_\_\_\_  
 MassDEP File #

\_\_\_\_\_  
 eDEP Transaction #

\_\_\_\_\_  
 City/Town

**F. Appeals**

The applicant, the owner, any person aggrieved by this Order, any owner of land abutting the land subject to this Order, or any ten residents of the city or town in which such land is located, are hereby notified of their right to request the appropriate MassDEP Regional Office to issue a Superseding Order of Conditions. The request must be made by certified mail or hand delivery to the Department, with the appropriate filing fee and a completed Request for Departmental Action Fee Transmittal Form, as provided in 310 CMR 10.03(7) within ten business days from the date of issuance of this Order. A copy of the request shall at the same time be sent by certified mail or hand delivery to the Conservation Commission and to the applicant, if he/she is not the appellant.

Any appellants seeking to appeal the Department's Superseding Order associated with this appeal will be required to demonstrate prior participation in the review of this project. Previous participation in the permit proceeding means the submission of written information to the Conservation Commission prior to the close of the public hearing, requesting a Superseding Order, or providing written information to the Department prior to issuance of a Superseding Order.

The request shall state clearly and concisely the objections to the Order which is being appealed and how the Order does not contribute to the protection of the interests identified in the Massachusetts Wetlands Protection Act (M.G.L. c. 131, § 40), and is inconsistent with the wetlands regulations (310 CMR 10.00). To the extent that the Order is based on a municipal ordinance or bylaw, and not on the Massachusetts Wetlands Protection Act or regulations, the Department has no appellate jurisdiction.



**CITY OF FITCHBURG**  
**CONSERVATION COMMISSION**

718 MAIN STREET  
FITCHBURG, MASSACHUSETTS 01420

(978) 829-1891  
PHONE

(978) 829-1965  
FAX

**SPECIAL CONDITIONS**  
**DEP FILE # 155-731**

The following special conditions shall be strictly adhered to:

1. This Order of Conditions shall apply to any successor in interest or successor in control.
2. The Commission shall be notified via email at least 48 hours prior to the commencement of the project.
3. Members of the Fitchburg Conservation Commission and its agent and environmental consultant shall have the right to enter and inspect the premises to evaluate compliance with these conditions and to require any data deemed necessary by the Commission for that evaluation.
4. The site engineer or contractor shall have a copy of this Order of Conditions at the site and available for inspection during all phases of construction.
5. All disturbed surfaces shall be permanently stabilized. Disturbed areas are to be loamed & seeded within two weeks of finish of site grading. Accepted and usual methods for controlling sedimentation and erosion shall be used during all phases of construction to protect wetlands and surface waters. Erosion control devices shall comply with the U.S. Natural Resources Conservation Services approved practices.
6. The Commission reserves the right to write additional orders should field conditions indicate that further conditions are required.
7. The applicant shall record this Order of Conditions at the Northern Worcester County Registry of Deeds.
8. Construction to be in conformance with approved plans as referenced in Order of Conditions. Any change in plans will require submittal of a new Notice of Intent.
9. Notify Conservation Commission agent when erosion controls are in place prior to construction.
10. A double line of Erosion Control Barriers are to be use on any slopes exceeding 3:1. All erosion control barriers and other mitigation measures shall be maintained in good working order to achieve the functions for which they were intended. A stockpile of spare Erosion Control Barriers are to be kept on site for use in case of emergencies.
11. Special care shall be taken to stabilize steep slopes with vegetation after disturbance, including watering to promote growth, if necessary.
12. Prior to the start of construction, the applicant's construction supervisor shall hold an on-site preconstruction meeting with a representative of the Commission to review the wetland delineation and the Order of Conditions.

**END OF SPECIAL CONDITIONS**

DOCUMENT A00871

**UNITED STATES DEPARTMENT OF THE INTERIOR**

**FISH AND WILDLIFE SERVICE**

**CONSISTENCY LETTER**

THIS PAGE INTENTIONALLY LEFT BLANK





## United States Department of the Interior



FISH AND WILDLIFE SERVICE  
New England Ecological Services Field Office  
70 Commercial Street, Suite 300  
Concord, NH 03301-5094  
Phone: (603) 223-2541 Fax: (603) 223-0104

In Reply Refer To:

August 09, 2023

Project code: 2023-0114270

Project Name: 607680 - FITCHBURG- BRIDGE REHABILITATION, F-04-010, RIVER STREET (ST 31) OVER NORTH NASHUA RIVER

Subject: Consistency letter for the '607680 - FITCHBURG- BRIDGE REHABILITATION, F-04-010, RIVER STREET (ST 31) OVER NORTH NASHUA RIVER' project under the amended February 5, 2018, FHWA, FRA, FTA Programmatic Biological Opinion (dated March 23, 2023) for Transportation Projects within the Range of the Indiana Bat and Northern Long-eared Bat (NLEB).

To whom it may concern:

The U.S. Fish and Wildlife Service (Service) has received your request dated August 09, 2023 to verify that the **607680 - FITCHBURG- BRIDGE REHABILITATION, F-04-010, RIVER STREET (ST 31) OVER NORTH NASHUA RIVER** (Proposed Action) may rely on the amended February 5, 2018, FHWA, FRA, FTA Programmatic Biological Opinion (dated March 23, 2023) for Transportation Projects within the Range of the Indiana Bat and Northern Long-eared Bat (PBO) to satisfy requirements under section 7(a)(2) of the Endangered Species Act of 1973 (ESA) (87 Stat.884, as amended; 16 U.S.C. 1531 *et seq.*).

Based on the information you provided (Project Description shown below), you have determined that the Proposed Action will have no effect on the endangered Indiana bat (*Myotis sodalis*) or the endangered northern long-eared bat (*Myotis septentrionalis*). If the Proposed Action is not modified, **no consultation is required for these two species**. If the Proposed Action is modified, or new information reveals that it may affect the Indiana bat and/or northern long-eared bat in a manner or to an extent not considered in the PBO, further review to conclude the requirements of ESA section 7(a)(2) may be required.

**For Proposed Actions that include bridge/culvert or structure removal, replacement, and/or maintenance activities:** If your initial bridge/culvert or structure assessments failed to detect Indiana bats and/or NLEB use or occupancy, yet later detected prior to, or during construction, please submit the Post Assessment Discovery of Bats at Bridge/Culvert or Structure Form (User Guide Appendix E) to this Service Office within 2 working days of the incident. In these

instances, potential incidental take of Indiana bats and/or NLEBs may be exempted provided that the take is reported to the Service.

If the Proposed Action may affect any other federally-listed or proposed species and/or designated critical habitat, additional consultation between the lead Federal action agency and this Service Office is required. If the proposed action has the potential to take bald or golden eagles, additional coordination with the Service under the Bald and Golden Eagle Protection Act may also be required. In either of these circumstances, please advise the lead Federal action agency accordingly.

The following species may occur in your project area and **are not** covered by this determination:

- Monarch Butterfly *Danaus plexippus* Candidate

## **PROJECT DESCRIPTION**

The following project name and description was collected in IPaC as part of the endangered species review process.

### **NAME**

607680 - FITCHBURG- BRIDGE REHABILITATION, F-04-010, RIVER STREET (ST 31)  
OVER NORTH NASHUA RIVER

### **DESCRIPTION**

607680 - FITCHBURG- BRIDGE REHABILITATION, F-04-010, RIVER STREET (ST 31)  
OVER NORTH NASHUA RIVER  
Work consists of rehabbing F-04-010.  
Monarch Butterfly: Candidate Species only, no conservation measures at this time.

The approximate location of the project can be viewed in Google Maps: <https://www.google.com/maps/@42.58696905,-71.80891908674282,14z>



## DETERMINATION KEY RESULT

Based on the information you provided, you have determined that the Proposed Action will have no effect on the endangered Indiana bat and/or the endangered northern long-eared bat.

Therefore, no consultation with the U.S. Fish and Wildlife Service pursuant to Section 7(a)(2) of the Endangered Species Act of 1973 (ESA) (87 Stat. 884, as amended 16 U.S.C. 1531 *et seq.*) is required for these two species.

## QUALIFICATION INTERVIEW

1. Is the project within the range of the Indiana bat<sup>[1]</sup>?

[1] See [Indiana bat species profile](#)

**Automatically answered**

*No*

2. Is the project within the range of the northern long-eared bat<sup>[1]</sup>?

[1] See [northern long-eared bat species profile](#)

**Automatically answered**

*Yes*

3. [Semantic] Does your proposed action intersect an area where Indiana bats and northern long-eared bats are not likely to occur?

**Automatically answered**

*Yes*

## **DETERMINATION KEY DESCRIPTION: FHWA, FRA, FTA PROGRAMMATIC CONSULTATION FOR TRANSPORTATION PROJECTS AFFECTING NLEB OR INDIANA BAT**

This key was last updated in IPaC on July 27, 2023. Keys are subject to periodic revision.

This decision key is intended for projects/activities funded or authorized by the Federal Highway Administration (FHWA), Federal Railroad Administration (FRA), and/or Federal Transit Administration (FTA), which may require consultation with the U.S. Fish and Wildlife Service (Service) under Section 7 of the Endangered Species Act (ESA) for the endangered **Indiana bat** (*Myotis sodalis*) and the endangered **northern long-eared bat** (NLEB) (*Myotis septentrionalis*).

This decision key should only be used to verify project applicability with the Service's [amended February 5, 2018, FHWA, FRA, FTA Programmatic Biological Opinion \(dated March 23, 2023\) for Transportation Projects](#). The programmatic biological opinion covers limited transportation activities that may affect either bat species, and addresses situations that are both likely and not likely to adversely affect either bat species. This decision key will assist in identifying the effect of a specific project/activity and applicability of the programmatic consultation. The programmatic biological opinion is not intended to cover all types of transportation actions. Activities outside the scope of the programmatic biological opinion, or that may affect ESA-listed species other than the Indiana bat or NLEB, or any designated critical habitat, may require additional ESA Section 7 consultation.

## **IPAC USER CONTACT INFORMATION**

Agency: Massachusetts Department of Transportation

Name: Trevor Burns

Address: 10 Park Plaza

City: Boston

State: MA

Zip: 02116

Email: trevor.b.burns@dot.state.ma.us

Phone: 8573010759

## **LEAD AGENCY CONTACT INFORMATION**

Lead Agency: Federal Highway Administration

THIS PAGE INTENTIONALLY LEFT BLANK



DOCUMENT A00875

**POLICY DIRECTIVE P-22-001  
AND  
POLICY DIRECTIVE P-22-002**

THIS PAGE INTENTIONALLY LEFT BLANK

## **POLICY DIRECTIVE**



HIGHWAY ADMINISTRATOR

### **Off-Site Stockpiling of Soil from MassDOT Construction Projects**

#### **Purpose**

The purpose of this Policy Directive is to formally establish a policy and procedures for managing and stockpiling soil generated and transported from MassDOT construction projects. This Policy Directive does not supersede any Federal, State, or Local regulations.

#### **Date of Effect**

This Policy Directive is effective immediately for all projects, including active construction projects.

For active construction projects and for other projects advertised prior to October 15, 2022, changes to the contract documents needed to implement the requirements of this Policy Directive will be considered on a case-by-case basis and shall be approved by the District Highway Director, as necessary.

For projects advertised on or after October 15, 2022, MassDOT will include the requirements and implementation procedures of this Policy Directive in the construction contract documents.

#### **Policy Requirements**

This policy is intended to prevent the off-site relocation of excavated soil generated from MassDOT projects to areas near sensitive receptors and to control potential fugitive dusts and/or contaminants. To that end, excavated soil may not be moved from the project site without knowledge of the content of the material. Knowledge may include visual field observations for presence of staining, odor, and/or debris, screening with a photoionization detector (PID), laboratory analysis, and/or site history. Pavement millings and other non-soil materials are not subject to the requirements of this Policy Directive.

Moving soil from a MassDOT project site to a temporary off-site storage location must be approved in writing by the District Highway Director.

The Contractor must select a storage location that is at least 500 feet away from sensitive receptors, as defined by the U.S. Environmental Protection Agency. In this context, sensitive receptors include, but are not limited to, hospitals, schools, daycare facilities, elderly housing and

convalescent facilities. These are areas where the occupants are more susceptible to the adverse effects of exposure to toxic chemicals, pesticides, and other pollutants. Extra care must be taken when dealing with contaminants and pollutants in close proximity to areas recognized as sensitive receptors.

Temporary off-site storage of excavated soil from a MassDOT project is only permissible at a location approved and permitted by MassDOT. The temporary storage location should be located within the same municipality where the soil was excavated, where possible. Stockpiled soil must be securely covered, and appropriate measures must be taken to minimize fugitive dust and erosion.

Signs indicating the source of the soil, the date the soil was generated, and contact information must be erected and maintained until the stockpiled soils are transported to a disposal facility or reused on the project site.

### **Implementation Procedures**

To ensure that off-site storage of excavated soils is managed properly on MassDOT projects, this policy requires the following:

#### **1. Off-Site Stockpile Storage Locations**

- a. The Contractor shall provide proposed off-site storage locations to the Engineer for approval at least 30 days prior to transporting soil off site. Off-site storage locations should be in the same municipality as the work site.
- b. The Contractor shall keep excavated soil on site until adequately characterized to the satisfaction of the Engineer.
- c. The Contractor shall provide notification of the approved off-site storage location to the local Board of Health and the Town Manager's/Mayor's Office at least 7-days prior to transporting soil off site.
- d. The Contractor shall provide the Engineer with at least 3-days' notice prior to transporting soil off site.
- e. For off-site storage locations on MassDOT property, the Contractor is required to obtain an Access Permit through the District Permits Office prior to storage of soil or other materials. MassDOT will issue these permits at no cost to the Contractor. Information to be submitted by the Contractor as part of the permit application shall include:
  - i. A description of material to be stored off-site, including available analytical data;
  - ii. A figure of the location with distances to residences and sensitive receptors; and
  - iii. Anticipated duration of temporary storage.
- f. Stockpile locations should not be within 500 feet of sensitive receptors (e.g., hospitals, schools, daycare facilities, elderly housing and convalescent facilities).
  - i. If the stockpile location must be within 500 feet of sensitive receptors, then soil must be less than RCS-1 (per 310 CMR 40.1600) and free of potentially hazardous or regulated items.

- g. For off-site storage locations on non-MassDOT property, the Contractor must notify the property owner(s) at least 7 days prior to transporting material.
- h. Exceptions to these rules will be reviewed by MassDOT and may be approved by the District Highway Director on a case-by-case basis.

## **2. Off-Site Stockpile Management**

- a. The Contractor shall keep soil stockpiles on impermeable surfaces (e.g., asphalt or concrete) or on 10-mil polyethylene sheeting.
- b. The Contractor shall cover soil stockpiles with 10-mil polyethylene sheeting and surround with a berm made of hay bales, straw wattles, or similar.
  - i. Piles that are actively being worked on must be covered and re-secured at the end of the work shift.
- c. The Contractor shall label stockpiles with signs, including:
  - i. Location of origin (including any Release Tracking Numbers)
  - ii. Stockpile ID number (including MassDOT District office-assigned tracking ID, if different)
  - iii. Date of initial accumulation
  - iv. Applicable telephone numbers for the Contractor and MassDOT.
- d. The Contractor shall mitigate fugitive dust at storage locations under the direction of an appropriately trained/certified environmental professional.
- e. The Contractor shall remedy noncompliance with this policy within 48 hours.
- f. The Contractor shall remedy noncompliance with this policy on the SAME DAY for potentially hazardous material, as determined by the Engineer.
- g. The Contractor shall handle excavated soil according to federal, state, and local regulations.
- h. The Contractor shall use appropriate shipping documents for all movements of excavated soil on public roadways (e.g., Bill of Lading, Material Shipping Record, Manifest, Asbestos Waste Shipment Record, etc.).

THIS PAGE INTENTIONALLY LEFT BLANK

## ***POLICY DIRECTIVE***

  
HIGHWAY ADMINISTRATOR

### **Use of MassDOT Property for Staging and other Construction-Related Operations**

#### **Purpose**

This Policy Directive is intended to address the use of MassDOT property by MassDOT Contractors for construction staging and other construction-related operations that are not specifically defined in the construction contract. Such use of MassDOT property will only be allowed if permitted by the District Office in accordance with 700 CMR 13.00, Approval of Access to MassDOT Highways and Other Property. This includes the use of MassDOT property for staging, laydown, and storage of equipment and materials, including soil excavated from a project site.

This Policy Directive requires the Contractor/applicant to obtain a Non-Vehicular Access Permit from MassDOT to use MassDOT property for these purposes.

This Policy Directive is effective immediately and applies to all MassDOT construction projects.

#### **General Permit Considerations and Conditions**

In addition to other normal MassDOT Access Permit procedures, MassDOT shall consider the following during the application, review, implementation and monitoring processes of Access Permits required by this Policy Directive:

- Storage and placement of the Contractor's equipment and materials should not be allowed within the clear zone of the roadway.
- Stockpiled soils should not be located within 500 feet of sensitive receptors, as defined by the U.S. Environmental Protection Agency. In this context, sensitive receptors include, but are not limited to, hospitals, schools, daycare facilities, elderly housing and convalescent facilities.
- The Contractor/applicant shall identify the access/egress locations of the proposed storage areas. MassDOT will only approve locations determined to be safe for roadway users, construction workers and the general public.
- The Contractor may be required to submit a Traffic Management Plan and/or Lighting Plan for MassDOT review and approval as part of the permit application, depending on the proposed use of the area.

- The Contractor shall submit the permit application through MassDOT's online State Highway Access Permit System (SHAPS).
- MassDOT will waive the permit application fee for any application received from a MassDOT Contractor for any permit required by this Policy Directive and will waive any subsequent amendment and extension fees that may otherwise be required.
- MassDOT will review the permit application in accordance with applicable standard procedures and will apply standard permit terms and conditions, as necessary.
- The Resident Engineer will verify that the permit is approved before allowing the Contractor to use the affected area for the requested purpose.
- Areas permitted are for use by the approved applicant only and are not to be shared with or used by other vendors. Subcontractors specifically engaged with the applicant working on the specific MassDOT project will be allowed to use the area in accordance with the terms of the permit.
- Permits are issued on an annual basis and will require the Contractor to file for an extension each year to continue use.

### **Exemptions from Permit Requirements**

Equipment and materials being used for active construction operations and located within the work zone of the construction contract are exempt from this permit requirement, provided they do not interfere with the safety or operation of the roadway or the work zone. Examples of these types of exempt uses are:

- Equipment and materials parked or stored within a protected (barriered) work zone.
- Materials placed in the work zone prior to same-day installation or use.
- Soils excavated temporarily and scheduled to be replaced, such as for trenching operations or for installation of drainage structures.



DOCUMENT B00420

PROPOSAL

FITCHBURG

For: **Bridge Rehabilitation, F-04-010, River Street (ST 31) over North Nashua River**

COMMONWEALTH OF MASSACHUSETTS

LOCATION

The work referred to herein is in the City of Fitchburg in Worcester County, in the Commonwealth of Massachusetts, and is shown by the locus map (Document 00331) in the Proposal Pamphlet, the work locations extend as follows:

**River Street (Route 31)**

**Beginning – Station 22+01.04 +/-**

**Ending –Station 26+79.10 +/-**

The contract prices shall include the furnishing of all materials (except as otherwise herein specified), the performing of all the labor requisite or proper, the providing of all necessary machinery, tools, apparatus and other means of construction, the doing of all the abovementioned work in the manner set forth, described and shown in the specifications and on the drawings for the work, and in the form of contract, and the completion thereof within **1040 CALENDAR DAYS** upon receipt of a Notice to Proceed, except that if the completion date falls between December 1 and March 15 then the same number of days beyond December 1st will be extended after March 15<sup>th</sup>.

The Work of this Project is described by the following Items and quantities.

THIS PAGE INTENTIONALLY LEFT BLANK

| Project # 607680  |          | Contract # 124171  |             |             |
|---|----------|--|-------------|-------------|
| Location : FITCHBURG  |          |  |             |             |
| Description : Bridge Rehabilitation, F-04-010, River Street (ST 31) over North Nashua River |          |  |             |             |
| ITEM #  | QUANTITY | ITEM WITH UNIT BID PRICE<br>WRITTEN IN WORDS   | UNIT PRICE  | AMOUNT      |
| 100.  | 1        | SCHEDULE OF OPERATIONS - FIXED PRICE \$43500<br><br>AT Forty Three Thousand Five Hundred Dollars<br>LUMP SUM | \$43,500.00 | \$43,500.00 |
| 100.95  | 1        | GEOTECHNICAL MONITORING AND INSTRUMENTATION<br><br>AT _____<br>LUMP SUM                                      |             |             |
| 100.99  | 1        | TELEVISION INSPECTION OF SEWER PIPES<br><br>AT _____<br>LUMP SUM   |             |             |
| 101.  | 0.07     | CLEARING AND GRUBBING<br><br>AT _____<br>PER ACRE  |             |             |
| 107.98  | 100      | STONE MASONRY CRACK REPAIRS<br><br>AT _____<br>PER FOOT  |             |             |
| 107.99  | 100      | STONE MASONRY POINTING REPAIRS<br><br>AT _____<br>PER FOOT   |             |             |
| 114.1   | 1        | DEMOLITION OF SUPERSTRUCTURE OF BRIDGE NO. F-04-010<br><br>AT _____<br>LUMP SUM                              |             |             |
| 120.1   | 360      | UNCLASSIFIED EXCAVATION<br><br>AT _____<br>PER CUBIC YARD  |             |             |
| 127.1   | 68       | REINFORCED CONCRETE EXCAVATION<br><br>AT _____<br>PER CUBIC YARD   |             |             |

| Project # 607680  |          | Contract # 124171   |            |        |
|---|----------|---|------------|--------|
| Location : FITCHBURG  |          |   |            |        |
| Description : Bridge Rehabilitation, F-04-010, River Street (ST 31) over North Nashua River |          |   |            |        |
| ITEM #  | QUANTITY | ITEM WITH UNIT BID PRICE<br>WRITTEN IN WORDS                          | UNIT PRICE | AMOUNT |
| 140.  | 683      | BRIDGE EXCAVATION<br><br>AT _____<br>PER CUBIC YARD                   |            |        |
| 141.1   | 30       | TEST PIT FOR EXPLORATION<br><br>AT _____<br>PER CUBIC YARD            |            |        |
| 142.  | 460      | CLASS B TRENCH EXCAVATION<br><br>AT _____<br>PER CUBIC YARD           |            |        |
| 144.  | 150      | CLASS B ROCK EXCAVATION<br><br>AT _____<br>PER CUBIC YARD             |            |        |
| 145.  | 1        | DRAINAGE STRUCTURE ABANDONED<br><br>AT _____<br>EACH                  |            |        |
| 146.  | 2        | DRAINAGE STRUCTURE REMOVED<br><br>AT _____<br>EACH                    |            |        |
| 150.1   | 64       | SPECIAL BORROW<br><br>AT _____<br>PER CUBIC YARD                      |            |        |
| 151.  | 168      | GRAVEL BORROW<br><br>AT _____<br>PER CUBIC YARD                       |            |        |
| 151.1   | 480      | GRAVEL BORROW FOR BRIDGE FOUNDATION<br><br>AT _____<br>PER CUBIC YARD |            |        |

| Project # 607680  |          | Contract # 124171  |            |        |
|---|----------|--|------------|--------|
| Location : FITCHBURG  |          |  |            |        |
| Description : Bridge Rehabilitation, F-04-010, River Street (ST 31) over North Nashua River |          |  |            |        |
| ITEM #  | QUANTITY | ITEM WITH UNIT BID PRICE<br>WRITTEN IN WORDS                                   | UNIT PRICE | AMOUNT |
| 153.1   | 3        | CONTROLLED DENSITY FILL - NON-EXCAVATABLE<br><br>AT _____<br>PER CUBIC YARD    |            |        |
| 156.  | 6        | CRUSHED STONE<br><br>AT _____<br>PER TON                                       |            |        |
| 156.13  | 84       | CRUSHED STONE FOR INTEGRAL ABUTMENT PILES<br><br>AT _____<br>PER TON           |            |        |
| 170.  | 524      | FINE GRADING AND COMPACTING - SUBGRADE AREA<br><br>AT _____<br>PER SQUARE YARD |            |        |
| 180.01  | 1        | ENVIRONMENTAL HEALTH AND SAFETY PROGRAM<br><br>AT _____<br>LUMP SUM            |            |        |
| 180.02  | 40       | PERSONAL PROTECTION LEVEL C UPGRADE<br><br>AT _____<br>PER HOUR                |            |        |
| 180.03  | 40       | LICENSED SITE PROFESSIONAL SERVICES<br><br>AT _____<br>PER HOUR                |            |        |
| 181.11  | 30       | DISPOSAL OF UNREGULATED SOIL<br><br>AT _____<br>PER TON                        |            |        |
| 181.12  | 30       | DISPOSAL OF REGULATED SOIL - IN-STATE FACILITY<br><br>AT _____<br>PER TON      |            |        |

| Project # 607680  |          | Contract # 124171   |            |        |
|---|----------|---|------------|--------|
| Location : FITCHBURG  |          |   |            |        |
| Description : Bridge Rehabilitation, F-04-010, River Street (ST 31) over North Nashua River |          |   |            |        |
| ITEM #  | QUANTITY | ITEM WITH UNIT BID PRICE<br>WRITTEN IN WORDS                                  | UNIT PRICE | AMOUNT |
| 181.13  | 15       | DISPOSAL OF REGULATED SOIL - OUT-OF-STATE FACILITY<br><br>AT _____<br>PER TON |            |        |
| 181.14  | 15       | DISPOSAL OF HAZARDOUS WASTE<br><br>AT _____<br>PER TON                        |            |        |
| 182.1   | 1        | INSPECTION AND TESTING FOR ASBESTOS<br><br>AT _____<br>LUMP SUM               |            |        |
| 182.21  | 1        | REMOVAL OF ASBESTOS<br><br>AT _____<br>LUMP SUM                               |            |        |
| 184.1   | 20       | DISPOSAL OF TREATED WOOD PRODUCTS<br><br>AT _____<br>PER TON                  |            |        |
| 203.  | 1        | SPECIAL MANHOLE<br><br>AT _____<br>EACH                                       |            |        |
| 210.02  | 1        | SANITARY SEWER MANHOLE REMOVED<br><br>AT _____<br>EACH                        |            |        |
| 220.  | 3        | DRAINAGE STRUCTURE ADJUSTED<br><br>AT _____<br>EACH                           |            |        |
| 220.7   | 1        | SANITARY STRUCTURE ADJUSTED<br><br>AT _____<br>EACH                           |            |        |

| Project # 607680  |          | Contract # 124171   |            |        |
|---|----------|---|------------|--------|
| Location : FITCHBURG  |          |   |            |        |
| Description : Bridge Rehabilitation, F-04-010, River Street (ST 31) over North Nashua River |          |   |            |        |
| ITEM #  | QUANTITY | ITEM WITH UNIT BID PRICE<br>WRITTEN IN WORDS                                | UNIT PRICE | AMOUNT |
| 220.8   | 1        | SANITARY STRUCTURE REMODELED<br><br>AT _____<br>EACH                        |            |        |
| 222.3   | 2        | FRAME AND GRATE (OR COVER) MUNICIPAL STANDARD<br><br>AT _____<br>EACH       |            |        |
| 227.3   | 4        | REMOVAL OF DRAINAGE STRUCTURE SEDIMENT<br><br>AT _____<br>PER CUBIC YARD    |            |        |
| 227.31  | 32       | REMOVAL OF DRAINAGE PIPE SEDIMENT<br><br>AT _____<br>PER FOOT               |            |        |
| 227.4   | 2        | MASONRY PLUG<br><br>AT _____<br>PER SQUARE FOOT                             |            |        |
| 230.9   | 1        | SANITARY SEWER TEMPORARY BYPASS<br><br>AT _____<br>LUMP SUM                 |            |        |
| 252.60  | 40       | 60 INCH CORRUGATED PLASTIC PIPE<br><br>AT _____<br>PER FOOT                 |            |        |
| 302.10  | 241      | 10 INCH DUCTILE IRON WATER PIPE (RUBBER GASKET)<br><br>AT _____<br>PER FOOT |            |        |
| 309.  | 936      | DUCTILE IRON FITTINGS FOR WATER PIPE<br><br>AT _____<br>PER POUND           |            |        |

| Project # 607680  |          | Contract # 124171   |            |        |
|---|----------|---|------------|--------|
| Location : FITCHBURG  |          |   |            |        |
| Description : Bridge Rehabilitation, F-04-010, River Street (ST 31) over North Nashua River |          |   |            |        |
| ITEM #  | QUANTITY | ITEM WITH UNIT BID PRICE<br>WRITTEN IN WORDS                                      | UNIT PRICE | AMOUNT |
| 350.10  | 4        | 10 INCH GATE AND GATE BOX<br><br>AT _____<br>EACH                                 |            |        |
| 367.10  | 2        | 10 INCH CAST IRON PLUG<br><br>AT _____<br>EACH                                    |            |        |
| 373.10  | 241      | 10 INCH WATER PIPE INSULATION<br><br>AT _____<br>PER FOOT                         |            |        |
| 402.  | 51       | DENSE GRADED CRUSHED STONE FOR SUB-BASE<br><br>AT _____<br>PER CUBIC YARD         |            |        |
| 415.2   | 144      | PAVEMENT FINE MILLING<br><br>AT _____<br>PER SQUARE YARD                          |            |        |
| 440.  | 1,377    | CALCIUM CHLORIDE FOR ROADWAY DUST CONTROL<br><br>AT _____<br>PER POUND            |            |        |
| 443.  | 5        | WATER FOR ROADWAY DUST CONTROL<br><br>AT _____<br>PER 1000 GALLONS                |            |        |
| 450.221   | 59       | SUPERPAVE SURFACE COURSE – 9.5 POLYMER (SSC – 9.5 - P)<br><br>AT _____<br>PER TON |            |        |
| 450.31  | 59       | SUPERPAVE INTERMEDIATE COURSE - 12.5 (SIC -12.5)<br><br>AT _____<br>PER TON       |            |        |



| Project # 607680  |          | Contract # 124171   |            |        |
|---|----------|---|------------|--------|
| Location : FITCHBURG  |          |   |            |        |
| Description : Bridge Rehabilitation, F-04-010, River Street (ST 31) over North Nashua River |          |   |            |        |
| ITEM #  | QUANTITY | ITEM WITH UNIT BID PRICE<br>WRITTEN IN WORDS                                      | UNIT PRICE | AMOUNT |
| 450.42  | 174      | SUPERPAVE BASE COURSE - 37.5 (SBC - 37.5)<br><br>AT _____<br>PER TON              |            |        |
| 450.60  | 40       | SUPERPAVE BRIDGE SURFACE COURSE - 9.5 (SSC-B - 9.5)<br><br>AT _____<br>PER TON    |            |        |
| 450.70  | 40       | SUPERPAVE BRIDGE PROTECTIVE COURSE - 9.5 (SPC-B - 9.5)<br><br>AT _____<br>PER TON |            |        |
| 451.  | 6        | HMA FOR PATCHING<br><br>AT _____<br>PER TON                                       |            |        |
| 452.  | 225      | ASPHALT EMULSION FOR TACK COAT<br><br>AT _____<br>PER GALLON                      |            |        |
| 453.  | 230      | HMA JOINT ADHESIVE<br><br>AT _____<br>PER FOOT                                    |            |        |
| 472.  | 6        | TEMPORARY ASPHALT PATCHING<br><br>AT _____<br>PER TON                             |            |        |
| 485.001   | 238      | COBBLESTONE ROTARY FEATURE<br><br>AT _____<br>PER SQUARE FOOT                     |            |        |
| 504.  | 70       | GRANITE CURB TYPE VA4 - STRAIGHT<br><br>AT _____<br>PER FOOT                      |            |        |

| Project # 607680  |          | Contract # 124171   |            |        |
|---|----------|---|------------|--------|
| Location : FITCHBURG  |          |   |            |        |
| Description : Bridge Rehabilitation, F-04-010, River Street (ST 31) over North Nashua River |          |   |            |        |
| ITEM #  | QUANTITY | ITEM WITH UNIT BID PRICE<br>WRITTEN IN WORDS  | UNIT PRICE | AMOUNT |
| 504.1   | 16       | GRANITE CURB TYPE VA4 - CURVED<br><br>AT _____<br>PER FOOT  |            |        |
| 509.  | 53       | GRANITE TRANSITION CURB FOR PEDESTRIAN CURB<br>RAMPS - STRAIGHT<br><br>AT _____<br>PER FOOT             |            |        |
| 509.1   | 27       | GRANITE TRANSITION CURB FOR PEDESTRIAN CURB<br>RAMPS - CURVED<br><br>AT _____<br>PER FOOT               |            |        |
| 521.  | 2        | CONCRETE CURB CORNER TYPE A<br><br>AT _____<br>EACH   |            |        |
| 580.  | 43       | CURB REMOVED AND RESET<br><br>AT _____<br>PER FOOT  |            |        |
| 582.  | 2        | CURB CORNER REMOVED AND RESET<br><br>AT _____<br>EACH   |            |        |
| 628.314   | 1        | TEMPORARY IMPACT ATTENUATOR, REDIRECTIVE, TL-2<br><br>AT _____<br>EACH                                  |            |        |
| 628.4   | 1        | TEMPORARY IMPACT ATTENUATOR, REMOVED AND<br>RESET<br><br>AT _____<br>EACH                               |            |        |
| 645.148   | 30       | 48 INCH CHAIN LINK FENCE (PIPE TOP RAIL) VINYL<br>COATED (LINE POST OPTION)<br><br>AT _____<br>PER FOOT |            |        |

| Project # 607680  |          | Contract # 124171   |            |        |
|---|----------|---|------------|--------|
| Location : FITCHBURG  |          |   |            |        |
| Description : Bridge Rehabilitation, F-04-010, River Street (ST 31) over North Nashua River |          |   |            |        |
| ITEM #  | QUANTITY | ITEM WITH UNIT BID PRICE<br>WRITTEN IN WORDS                                | UNIT PRICE | AMOUNT |
| 657.  | 270      | TEMPORARY FENCE<br><br>AT _____<br>PER FOOT                                 |            |        |
| 657.5   | 270      | TEMPORARY FENCE REMOVED AND RESET<br><br>AT _____<br>PER FOOT               |            |        |
| 697.1   | 3        | SILT SACK<br><br>AT _____<br>EACH   |            |        |
| 701.  | 57       | CEMENT CONCRETE SIDEWALK<br><br>AT _____<br>PER SQUARE YARD                 |            |        |
| 701.1   | 64       | CEMENT CONCRETE SIDEWALK AT DRIVEWAYS<br><br>AT _____<br>PER SQUARE YARD    |            |        |
| 701.2   | 37       | CEMENT CONCRETE PEDESTRIAN CURB RAMP<br><br>AT _____<br>PER SQUARE YARD     |            |        |
| 710.4   | 1        | BOUND - PLAIN GRANITE<br><br>AT _____<br>EACH                               |            |        |
| 711.  | 1        | BOUND REMOVED AND RESET<br><br>AT _____<br>EACH                             |            |        |
| 740.  | 35       | ENGINEER'S FIELD OFFICE AND EQUIPMENT (TYPE A)<br><br>AT _____<br>PER MONTH |            |        |

| Project # 607680  |          | Contract # 124171  |            |        |
|---|----------|--|------------|--------|
| Location : FITCHBURG  |          |  |            |        |
| Description : Bridge Rehabilitation, F-04-010, River Street (ST 31) over North Nashua River |          |  |            |        |
| ITEM #  | QUANTITY | ITEM WITH UNIT BID PRICE<br>WRITTEN IN WORDS                             | UNIT PRICE | AMOUNT |
| 748.  | 1        | MOBILIZATION<br><br>AT _____<br>LUMP SUM                                 |            |        |
| 748.2   | 1        | PRE-CONSTRUCTION SURVEY<br><br>AT _____<br>LUMP SUM                      |            |        |
| 751.  | 3        | LOAM FOR ROADSIDES<br><br>AT _____<br>PER CUBIC YARD                     |            |        |
| 751.1   | 13       | LOAM FOR LAWNS<br><br>AT _____<br>PER CUBIC YARD                         |            |        |
| 756.  | 1        | NPDES STORMWATER POLLUTION PREVENTION PLAN<br><br>AT _____<br>LUMP SUM   |            |        |
| 765.  | 20       | SEEDING<br><br>AT _____<br>PER SQUARE YARD                               |            |        |
| 767.121   | 130      | SEDIMENT CONTROL BARRIER<br><br>AT _____<br>PER FOOT                     |            |        |
| 801.44  | 172      | 4 INCH ELECTRICAL CONDUIT - TYPE NM (4 BANK)<br><br>AT _____<br>PER FOOT |            |        |
| 801.46  | 215      | 4 INCH ELECTRICAL CONDUIT - TYPE NM (6 BANK)<br><br>AT _____<br>PER FOOT |            |        |

| Project # 607680  |          | Contract # 124171   |            |        |
|---|----------|---|------------|--------|
| Location : FITCHBURG  |          |   |            |        |
| Description : Bridge Rehabilitation, F-04-010, River Street (ST 31) over North Nashua River |          |   |            |        |
| ITEM #  | QUANTITY | ITEM WITH UNIT BID PRICE<br>WRITTEN IN WORDS  | UNIT PRICE | AMOUNT |
| 812.13  | 1        | LIGHT STANDARD FOUNDATION SD3.013<br><br>AT _____<br>EACH                           |            |        |
| 812.30  | 1        | STANDARD SIGNAL POST FOUNDATION SD3.030<br><br>AT _____<br>EACH                     |            |        |
| 823.70  | 1        | HIGHWAY LIGHTING POLE AND LUMINAIRE REMOVED AND RESET<br><br>AT _____<br>EACH       |            |        |
| 824.50  | 1        | FLASHING WARNING BEACON REMOVED AND RESET<br><br>AT _____<br>LUMP SUM               |            |        |
| 847.1   | 3        | SIGN SUP (N/GUIDE)+RTE MKR W/1 BRKWAY POST ASSEMBLY - STEEL<br><br>AT _____<br>EACH |            |        |
| 852.  | 432      | SAFETY SIGNING FOR TRAFFIC MANAGEMENT<br><br>AT _____<br>PER SQUARE FOOT            |            |        |
| 853.1   | 3        | PORTABLE BREAKAWAY BARRICADE TYPE III<br><br>AT _____<br>EACH                       |            |        |
| 853.2   | 289      | TEMPORARY BARRIER (TL-2)<br><br>AT _____<br>PER FOOT                                |            |        |
| 853.21  | 207      | TEMPORARY BARRIER REMOVED AND RESET<br><br>AT _____<br>PER FOOT                     |            |        |

| Project # 607680  |          | Contract # 124171   |            |        |
|---|----------|---|------------|--------|
| Location : FITCHBURG  |          |   |            |        |
| Description : Bridge Rehabilitation, F-04-010, River Street (ST 31) over North Nashua River |          |   |            |        |
| ITEM #  | QUANTITY | ITEM WITH UNIT BID PRICE<br>WRITTEN IN WORDS  | UNIT PRICE | AMOUNT |
| 853.8   | 32       | TEMPORARY ILLUMINATION FOR WORK ZONE<br><br>AT _____<br>PER DAY                                       |            |        |
| 854.016   | 410      | TEMPORARY PAVING MARKINGS - 6 INCH (PAINTED)<br><br>AT _____<br>PER FOOT                              |            |        |
| 854.1   | 440      | PAVEMENT MARKING REMOVAL<br><br>AT _____<br>PER SQUARE FOOT   |            |        |
| 856.  | 1,047    | ARROW BOARD<br><br>AT _____<br>PER DAY  |            |        |
| 856.12  | 1,047    | PORTABLE CHANGEABLE MESSAGE SIGN<br><br>AT _____<br>PER DAY   |            |        |
| 859.  | 18,846   | REFLECTORIZED DRUM<br><br>AT _____<br>PER DAY   |            |        |
| 859.1   | 3,360    | REFLECTORIZED DRUMS WITH SEQUENTIAL FLASHING<br>WARNING LIGHTS<br><br>AT _____<br>PER DAY             |            |        |
| 864.  | 140      | PAVEMENT ARROW REFLECTORIZED WHITE (PAINTED)<br><br>AT _____<br>PER SQUARE FOOT                       |            |        |
| 864.04  | 36       | PAVEMENT ARROWS AND LEGENDS REFLECTORIZED<br>WHITE (THERMOPLASTIC)<br><br>AT _____<br>PER SQUARE FOOT |            |        |

| Project # 607680  |          | Contract # 124171   |            |        |
|---|----------|---|------------|--------|
| Location : FITCHBURG  |          |   |            |        |
| Description : Bridge Rehabilitation, F-04-010, River Street (ST 31) over North Nashua River |          |   |            |        |
| ITEM #  | QUANTITY | ITEM WITH UNIT BID PRICE<br>WRITTEN IN WORDS                                      | UNIT PRICE | AMOUNT |
| 866.106   | 390      | 6 INCH REFLECTORIZED WHITE LINE (THERMOPLASTIC)<br><br>AT _____<br>PER FOOT       |            |        |
| 866.112   | 150      | 12 INCH REFLECTORIZED WHITE LINE (THERMOPLASTIC)<br><br>AT _____<br>PER FOOT      |            |        |
| 867.106   | 240      | 6 INCH REFLECTORIZED YELLOW LINE (THERMOPLASTIC)<br><br>AT _____<br>PER FOOT      |            |        |
| 874.2   | 3        | TRAFFIC SIGN REMOVED AND RESET<br><br>AT _____<br>EACH                            |            |        |
| 901.01  | 17       | CONCRETE FOR FLOOD WALL<br><br>AT _____<br>PER CUBIC YARD                         |            |        |
| 910.11  | 1,000    | STEEL REINFORCEMENT FOR FLOOD WALL - EPOXY<br>COATED<br><br>AT _____<br>PER POUND |            |        |
| 912.3   | 56       | DRILLED & GROUTED #3 DOWELS<br><br>AT _____<br>EACH                               |            |        |
| 942.102   | 890      | STEEL PILE HP 10 X 57<br><br>AT _____<br>PER FOOT                                 |            |        |
| 944.2   | 320      | PRE-DRILLING FOR PILES<br><br>AT _____<br>PER FOOT                                |            |        |

| Project # 607680  |          | Contract # 124171  |            |        |
|---|----------|--|------------|--------|
| Location : FITCHBURG  |          |  |            |        |
| Description : Bridge Rehabilitation, F-04-010, River Street (ST 31) over North Nashua River |          |  |            |        |
| ITEM #  | QUANTITY | ITEM WITH UNIT BID PRICE<br>WRITTEN IN WORDS   | UNIT PRICE | AMOUNT |
| 944.21  | 890      | TEST PROBING FOR PILE OBSTRUCTIONS<br><br>AT _____<br>PER FOOT                           |            |        |
| 944.3   | 270      | DRILLING FOR PILE OBSTRUCTIONS<br><br>AT _____<br>PER FOOT                               |            |        |
| 948.41  | 2        | DYNAMIC LOAD TEST BY CONTRACTOR<br><br>AT _____<br>EACH                                  |            |        |
| 948.5   | 18       | PILE SHOES<br><br>AT _____<br>EACH   |            |        |
| 953.1   | 180      | TEMPORARY SUPPORT OF EXCAVATION<br><br>AT _____<br>PER SQUARE YARD                       |            |        |
| 987.31  | 18       | SPECIAL SLOPE PAVING UNDER BRIDGE - CEMENT<br>CONCRETE<br><br>AT _____<br>PER CUBIC YARD |            |        |
| 989.2   | 1        | REPAIRS TO CONCRETE<br><br>AT _____<br>LUMP SUM  |            |        |
| 991.1   | 1        | CONTROL OF WATER - STRUCTURE NO. F-04-010<br><br>AT _____<br>LUMP SUM                    |            |        |
| 992.3   | 1        | TEMPORARY SUPPORTS FOR BRIDGE STRUCTURE<br><br>AT _____<br>LUMP SUM                      |            |        |



| <b>Project # 607680</b>  |                 | <b>Contract # 124171</b>  |                   |               |
|--|-----------------|---|-------------------|---------------|
| <b>Location : FITCHBURG</b>  |                 |   |                   |               |
| <b>Description : Bridge Rehabilitation, F-04-010, River Street (ST 31) over North Nashua River</b> |                 |   |                   |               |
| <b>ITEM #</b>  | <b>QUANTITY</b> | <b>ITEM WITH UNIT BID PRICE<br/>WRITTEN IN WORDS</b>                        | <b>UNIT PRICE</b> | <b>AMOUNT</b> |
| 993.1  | 1               | TEMPORARY BRIDGE NO. F-04-010T<br><br>AT _____<br>LUMP SUM                  |                   |               |
| 995.   | 1               | BRIDGE SUPERSTRUCTURE, BRIDGE NO.F-04-010 (1KR)<br><br>AT _____<br>LUMP SUM |                   |               |
| <b>Total Qty:</b>  |                 | 39,930.07   |                   |               |

THIS PAGE INTENTIONALLY LEFT BLANK

DOCUMENT B00842

SCHEDULE OF PARTICIPATION  
BY MINORITY OR WOMEN BUSINESS ENTERPRISES (M/WBE)

MASSDOT PROJECT NUMBER: 607680

PROJECT LOCATION: FITCHBURG

DATE OF BID OPENING: \_\_\_\_\_

NAME OF PRIME BIDDER: \_\_\_\_\_

| Name Address and Phone Number of M/WBE | Name of Activity               | (a)<br>M/WBE Contractor Activity Amount | (b)<br>M/WBE Other Business Amount | (c)<br>Total amount eligible for credit under rules in Section VIII of the Special Provisions |
|--|--------------------------------|---|------------------------------------|---|
|  |                                |   |                                    |   |
|  |                                |   |                                    |   |
|  |                                |   |                                    |   |
|  |                                |   |                                    |   |
|  |                                |   |                                    |   |
|  |                                |   |                                    |   |
| Total Bid Amount                       | TOTALS:                        | \$                                      |                                    | \$  |
| \$                                     | M/WBE Percentage of Total bid: | %                                       |                                    | %   |

Column (a) must be at least one-half of the M/WBE percentage goal.

SIGNATURE: \_\_\_\_\_ Date: \_\_\_\_\_ Tel No: \_\_\_\_\_

NAME AND TITLE (PRINT): \_\_\_\_\_

BIDDERS ARE CAUTIONED TO REVIEW DOCUMENT 00718 -- SPECIAL PROVISION FOR PARTICIPATION BY MINORITY OR WOMEN BUSINESS ENTERPRISES AND SERVICE DISABLED VETERAN OWNED BUSINESS ENTERPRISES.

\*\*\* END OF DOCUMENT \*\*\*

THIS PAGE INTENTIONALLY LEFT BLANK

DOCUMENT B00843

MINORITY OR WOMEN'S BUSINESS ENTERPRISE PARTICIPATION LETTER OF INTENT  
PAGE 1 OF 2

MASSDOT PROJECT NUMBER: 607680

PROJECT LOCATION: FITCHBURG

DATE OF BID OPENING: \_\_\_\_\_

FROM \_\_\_\_\_

(Minority or Women's Business Enterprise Company)

TO: \_\_\_\_\_

(Name of Prime Contractor)

1. My company is currently certified as an MBE or WBE by the Massachusetts Supplier Diversity Office, formerly known as the State Office of Minority and Women Business Assistance (SOMWBA). There have been no changes affecting the ownership, control or independence of my company since my last certification review.
2. If any such change occurs prior to my company's completion of this proposed work, I will give written notification to your firm and to the Massachusetts Department of Transportation (MassDOT).
3. (For contractor activity only.) My firm will provide to you, upon request, for the purpose of obtaining subcontractor approval from MassDOT; (1) a resume stating the qualifications and experience of the superintendent or foreperson who will supervise on site-work; (2) a list of equipment owned or leased by my firm for use on the project; (3) a list of all projects (public or private) which my firm is currently performing, is committed to perform, or intends to make a commitment to perform. I shall include, for each project, the names and telephone number of a contact person for the contracting organization, the dollar value of the work, a description of the work, and my firm's work schedule for the Project.
4. If you are awarded the Contract, my company intends to enter into an agreement with your firm to perform the items of work or other activity described on the following sheet for the prices indicated.
5. My firm has the ability to manage, supervise and perform the activity described on the following page.

\_\_\_\_\_  
M/WBE Authorized Signature

\_\_\_\_\_  
Date

MINORITY OR WOMEN'S BUSINESS ENTERPRISE PARTICIPATION LETTER OF INTENT  
PAGE 2 OF 2

MASSDOT PROJECT NUMBER: 607680

PROJECT LOCATION: FITCHBURG

DATE OF BID OPENING: \_\_\_\_\_

NAME OF PRIME BIDDER: \_\_\_\_\_

| <u>Item number</u><br>if applicable | <u>Description of Activity</u><br>with notations such as Installation Only, Material Only, or Complete | <u>Quantity</u> | <u>Unit Price</u> | <u>Amount</u> |
|-------------------------------------|--|-----------------|-------------------|---------------|
|                                     |  |                 |                   |               |
|                                     |  |                 |                   |               |
|                                     |  |                 |                   |               |
|                                     |  |                 |                   |               |
|                                     |  |                 |                   |               |
|                                     |  |                 |                   |               |
|                                     |  |                 |                   |               |
| TOTAL AMOUNT:                       |  |                 |                   |               |

M/WBE COMPANY NAME: \_\_\_\_\_

M/WBE AUTHORIZED SIGNATURE: \_\_\_\_\_

NAME AND TITLE (PRINT): \_\_\_\_\_

TELEPHONE NUMBER: \_\_\_\_\_ FAX NUMBER: \_\_\_\_\_

\*\*\* END OF DOCUMENT \*\*\*

Rev'd 9/20/19

DOCUMENT B00846

M/WBE OR SDVOBE JOINT CHECK ARRANGEMENT APPROVAL FORM

(to be submitted by Prime Contractor)

Contract No: 124171 Project No: 607680

Location: Fitchburg Bid Opening Date:

Project Description: Bridge Rehabilitation, F-04-010, River Street (ST 31) over North Nashua River

We have received the attached request for the use of a joint check arrangement from \_\_\_\_\_, an M/WBE or SDVOBE on the above- referenced Contract and \_\_\_\_\_, a Material Supplier/Vendor for the subject Contract. The M/WBE or SDVOBE has complied with the requirements of Special Provision Document 00718. In particular, the M/WBE or SDVOBE has:

- a written agreement with the material supplier/vendor;
• applied for credit with the subject material supplier and has supplied the vendor's response;
• shown that it will place all orders to the subject material supplier/vendor;
• made and retains all decision-making responsibilities concerning the materials; and
• provided a Joint Check Agreement that is acceptable to MassDOT;

As the Contractor for the Project, we agree to issue joint checks (made payable to the Material Supplier/Vendor and the M/WBE or SDVOBE) for payment of sums due pursuant to invoices from the Supplier/Vendor and M/WBE or SDVOBE.

Contractor:

Company Name

Signature
Duly Authorized

Printed Name

Date

Title

Subcontractor:

Company Name

Signature
Duly Authorized

Printed Name

Date

Title

\*\*\* END OF DOCUMENT \*\*\*

THIS PAGE INTENTIONALLY LEFT BLANK



DOCUMENT B00847

JOINT VENTURE AFFIDAVIT  
(All Firms)

- All Information Requested By This Schedule Must Be Answered. Additional Sheets May Be Attached.
- If, there is any change in the information submitted, the Joint Venture parties must inform MassDOT Pre-Qualifications Office (and, if one of the companies is a M/WBE or SDVOBE, the Director of Contract Compliance, Office of Civil Rights) *prior* to such change, in writing, either directly or through the Prime Contractor if the Joint Venture is a subcontractor.
- If the Joint Venture Entity will be the bidder on a prime Contract, it must bid and submit all required documents (insurance, worker’s compensation, bonds, etc.) in the name of the Joint Venture Entity.

**I. Name of Joint Venture:** \_\_\_\_\_

Type of Entity if applicable (Corp., LLC): \_\_\_\_\_ Filing State \_\_\_\_\_

Address of joint venture: \_\_\_\_\_

Phone No(s) for JV Entity: \_\_\_\_\_ E-mail: \_\_\_\_\_

Contact Person(s) \_\_\_\_\_

Tax ID/EIN of Joint Venture: \_\_\_\_\_ Vendor Code: \_\_\_\_\_

**II. Identify each firm or party to the Joint Venture:**

Name of Firm: \_\_\_\_\_

Address: \_\_\_\_\_

Phone : \_\_\_\_\_ E-mail: \_\_\_\_\_

Contact person(s) \_\_\_\_\_

Name of Firm: \_\_\_\_\_

Address: \_\_\_\_\_

Phone: \_\_\_\_\_ E-mail: \_\_\_\_\_

Contact Person(s) \_\_\_\_\_

**III. Describe the role(s) of the each party to the Joint Venture:**

\_\_\_\_\_  
\_\_\_\_\_

**IV. Attach a copy of the Joint Venture Agreement.** The proposed Joint Venture Agreement should include specific details including, but not limited to: (1) the contributions of capital and equipment; (2) work items to be performed by each company’s forces, (3) work items to be performed under the supervision of any M/WBE or SDVOBE Venturer; (4) the commitment of management, supervisory and operative personnel employed by the M/WBE or SDVOBE to be dedicated to the performance of the Project; and (5) warranty, guaranty, and indemnification clauses.

**V. Attach any applicable Corporate or LLC Votes, Authorizations, etc.**

**VI. Ownership of the Joint Venture:**

A. What is the percentage(s) of each company's ownership in the Joint Venture?

ownership percentage(s): \_\_\_\_\_

ownership percentage(s): \_\_\_\_\_

B. Specify percentages for each of the following (provide narrative descriptions and other detail as applicable):

1. Sharing of profit and loss: \_\_\_\_\_

2. Capital contributions:

(a) Dollar amounts of initial contribution: \_\_\_\_\_

(b) Dollar amounts of anticipated on-going contributions: \_\_\_\_\_

(c) Contributions of equipment (specify types, quality and quantities of equipment to be provided by each firm): \_\_\_\_\_

4. Other applicable ownership interests, including ownership options or other agreements, which restrict or limit ownership and/or control:

\_\_\_\_\_  
\_\_\_\_\_

5. Provide copies of all other written agreements between firms concerning bidding and operation of this Project or projects or contracts.

6. Identify all current contracts and contracts completed during the past two (2) years by either of the Joint Venture partners to this Joint Venture:

\_\_\_\_\_  
\_\_\_\_\_

**VII. Control of and Participation in the Joint Venture.** Identify by name and firm those individuals who are, or will be, responsible for and have the authority to engage in the following management functions and policy decisions. (Indicate any limitations to their authority such as dollar limits and co-signatory requirements.):

A. Joint Venture check signing:

\_\_\_\_\_  
\_\_\_\_\_

B. Authority to enter Contracts on behalf of the Joint Venture:

\_\_\_\_\_  
\_\_\_\_\_

C. Signing, co-signing and/or collateralizing loans:

\_\_\_\_\_  
\_\_\_\_\_

D. Acquisition of lines of credit:

\_\_\_\_\_  
\_\_\_\_\_

E. Acquisition and indemnification of payment and performance bonds:

\_\_\_\_\_  
\_\_\_\_\_

F. Negotiating and signing labor agreements:

\_\_\_\_\_  
\_\_\_\_\_

G. Management of contract performance. (*Identify by name and firm only*):

1. Supervision of field operations: \_\_\_\_\_
2. Major purchases: \_\_\_\_\_
3. Estimating: \_\_\_\_\_
4. Engineering: \_\_\_\_\_

**VIII. Financial Controls of Joint Venture:**

A. Which firm and/or individual will be responsible for keeping the books of account?

\_\_\_\_\_  
\_\_\_\_\_

B. Identify the "Managing Partner," if any, and describe the means and measure of their compensation:

\_\_\_\_\_  
\_\_\_\_\_

C. What authority does each firm have to commit or obligate the other to insurance and bonding companies, financing institutions, suppliers, subcontractors, and/or other parties participating in the performance of this Contract or the work of this Project?

\_\_\_\_\_

**IX. Personnel of Joint Venture:** State the approximate number of personnel (by trade) needed to perform the Joint Venture's work under this Contract. Indicate whether they will be employees of the majority firm, M/WBE or SDVOBE firm, or the Joint Venture.

|                         | Firm 1<br>(number) | Firm 2<br>(number) | Joint Venture<br>(number) |
|-------------------------|--------------------|--------------------|---------------------------|
| Trade                   |                    |                    |                           |
|                         |                    |                    |                           |
| Professional            |                    |                    |                           |
|                         |                    |                    |                           |
| Administrative/Clerical |                    |                    |                           |
|                         |                    |                    |                           |
| Unskilled Labor         |                    |                    |                           |
|                         |                    |                    |                           |

Will any personnel proposed for this Project be employees of the Joint Venture?: \_\_\_\_\_

If so, who: \_\_\_\_\_

A. Are any proposed Joint Venture employees currently employed by either firm?

Employed by Firm 1: \_\_\_\_\_ Employed by firm 2 \_\_\_\_\_

B. Identify by name and firm the individual who will be responsible for Joint Venture hiring: \_\_\_\_\_

\_\_\_\_\_

**X. Additional Information.** Please state any material facts and additional information pertinent to the control and structure of this Joint Venture.

\_\_\_\_\_  
\_\_\_\_\_

**XI. AFFIDAVIT OF JOINT VENTURE PARTIES.** The undersigned affirm that the foregoing statements and attached documents are correct and include all material information necessary to identify and explain the terms and operations of our Joint Venture and the intended participation of each firm in the undertaking. Further, the undersigned covenant and agree to provide to MassDOT current, complete and accurate information regarding actual Joint Venture work, payments, and any proposed changes to any provisions of the Joint Venture, or the nature, character of each party to the Joint Venture. We understand that any material misrepresentation will be grounds for terminating any Contract awarded and for initiating action under Federal or State laws concerning false statements.

\_\_\_\_\_  
Firm 1

\_\_\_\_\_  
Firm 2

\_\_\_\_\_  
Signature  
Duly Authorized

\_\_\_\_\_  
Signature  
Duly Authorized

\_\_\_\_\_  
Printed Name and Title

\_\_\_\_\_  
Printed Name and Title

\_\_\_\_\_  
Date

\_\_\_\_\_  
Date

\*\*\* END OF DOCUMENT \*\*\*